

CABLE RANGE

2P3W - .375 TO .437 O.D.

3P4W - .406 TO .562 O.D.

ASSEMBLY INSTRUCTIONS:

1. PLACE SMALL RING CAP ①, NEOPRENE GROMMET ② AND PLUG SPACER ③ OVER CABLE.

2. STRIP WIRES 7/16".

3. INSTALL WIRES INTO PLUG INTERIOR ④.

4. SLIDE PLUG INTERIOR ④ INTO PLUG BODY ⑤.

5. APPLY THE LUBRICANT PROVIDED TO THE INSIDE THREADS OF SMALL RING CAP ① AND TO THE TOP AND AROUND THE TAPERED EDGE OF NEOPRENE GROMMET ② PRIOR TO ASSEMBLY.

** EXCEEDING THE CABLE RANGE OR OVER TIGHTENING SMALL RING CAP WILL DAMAGE THE CAP.**

6. TIGHTEN SMALL RING CAP ① ONTO PLUG BODY ⑤ COMPRESSING THE NEOPRENE GROMMET ②.

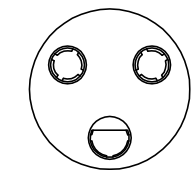
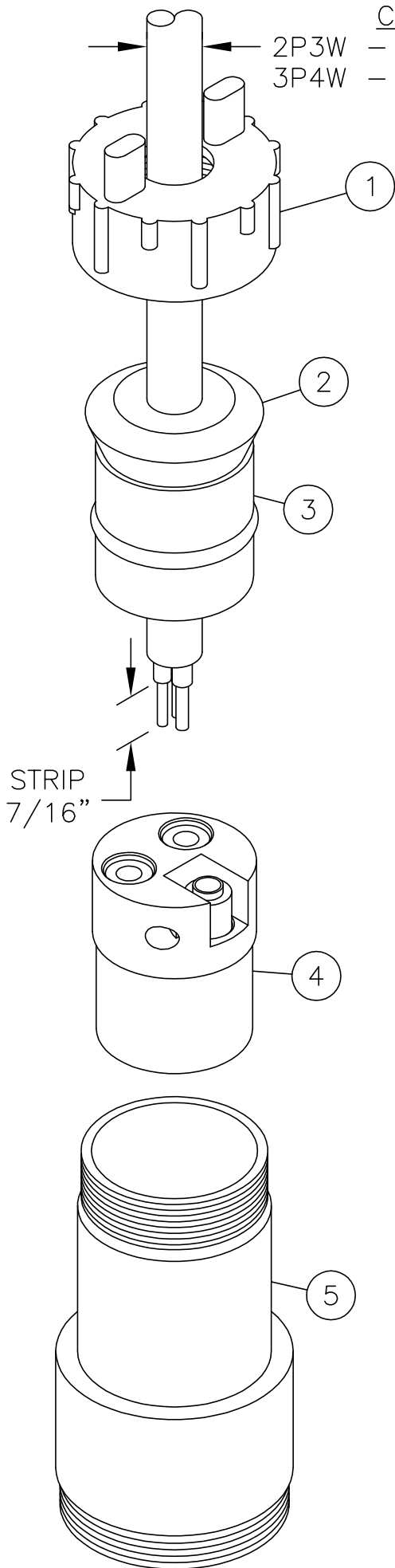

422FC-125

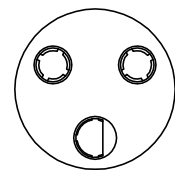

422FC-250

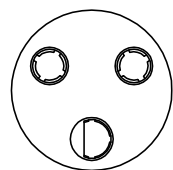

422FC-277

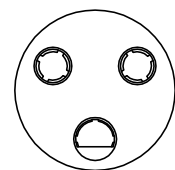

422FC-480

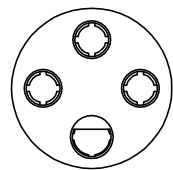

423FC-125

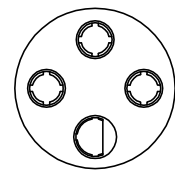

423FC-250

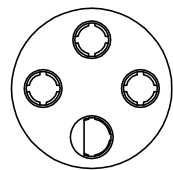

423FC-480

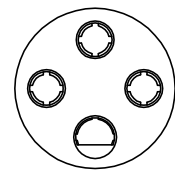

423FC-600