

CABLE RANGE

2P3W - .375 TO .437 O.D.

3P4W - .406 TO .562 O.D.

ASSEMBLY INSTRUCTIONS:

1. PLACE SMALL RING CAP ①, NEOPRENE GROMMET ② AND PLUG SPACER ③ OVER CABLE. INSTALL ITEM ③A (1/8" DIAMETER O-RING) ONTO SPACER.

2. STRIP WIRES 7/16".

3. INSTALL WIRES INTO PLUG INTERIOR ④.

4. SLIDE PLUG INTERIOR ④ INTO LARGE RING ⑤ AND PLUG BODY ⑥.

5. APPLY THE LUBRICANT PROVIDED TO THE INSIDE THREADS OF SMALL RING CAP ① AND TO THE TOP AND AROUND THE TAPERED EDGE OF NEOPRENE GROMMET ② PRIOR TO ASSEMBLY.

** EXCEEDING THE CABLE RANGE OR OVER TIGHTENING SMALL RING CAP WILL DAMAGE THE CAP.**

6. TIGHTEN SMALL RING CAP ① ONTO PLUG BODY ⑥, COMPRESSING THE NEOPRENE GROMMET ②. INSTALL ITEM ⑥A (1/16" DIAMETER O-RING) ONTO PLUG BODY.

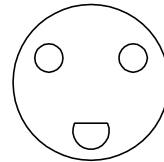
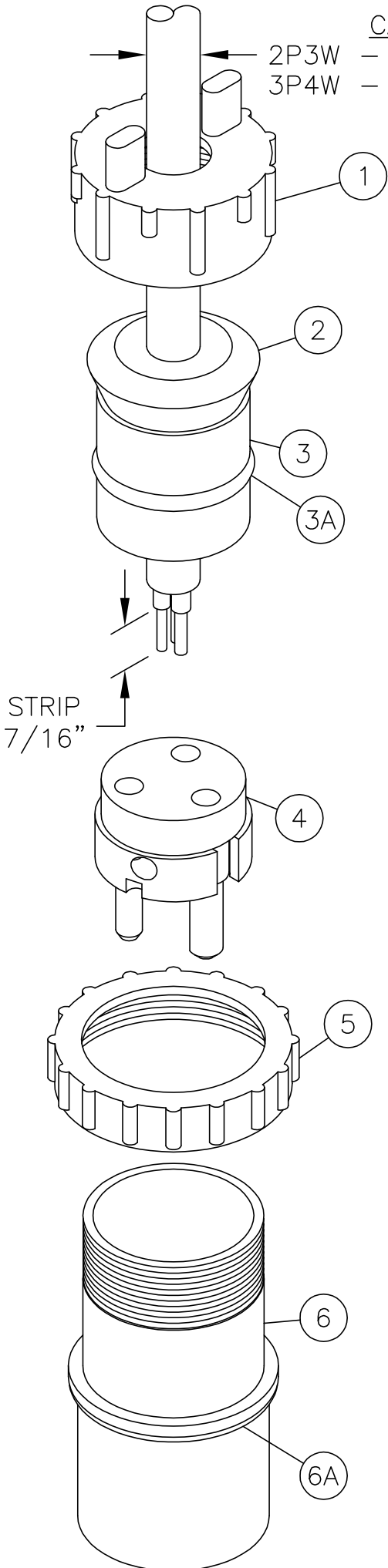

420PP-125

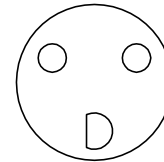

420PP-250

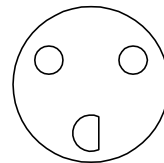

420PP-277

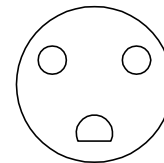

420PP-480

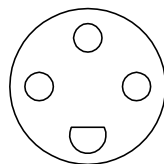

420-4PP-125

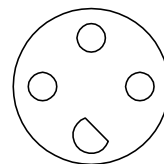

420-4PP-208

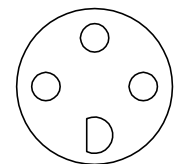

420-4PP-250

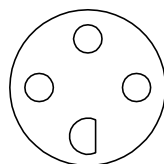

420-4PP-480

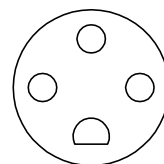

420-4PP-600