

## KDG3V-5/7/8, 10 Series

Single-Stage with Hydraulic Pilot Operation  
High Flow Proportional Directional Control Valves

### Basic Characteristics

- Max. pressure ..... up to 350 bar  
(5000 psi)
- Max. flow rate ..... up to 700 L/min  
(190 USgpm)
- Mounting interfaces to ISO 4401:  
 KDG3V-5 ..... Size 05\*  
 KDG3V-7 ..... Size 07  
 KDG3V-8 ..... Size 08

u\* With additional pilot ports X and Y.

### General Description

The remote control facility of these high flow capacity valves allows them to be installed in optimum locations relative to minimizing power transmission losses, close to actuators and distant from machine operators. Remote control can then be achieved using any suitable variable pressure control such as Vickers HRC type hydraulic remote controls which are available with a number of joystick and footpedal options and electrical switch features.

In KDG3V valves, the spool is centered by a spring when the differential of pilot pressures applied to the valve end chambers is less than approx. 6 bar (87 psi). As the pilot pressure differential

### Typical Sectional Arrangement

KDG3V-7

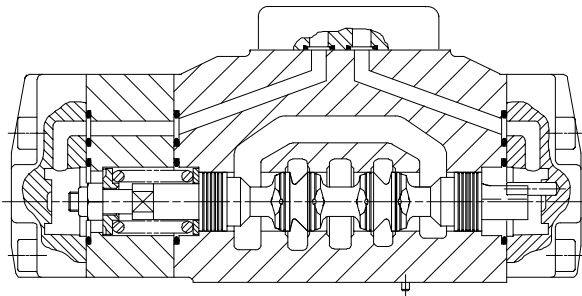

is increased the spool is moved from its centered position, and at approx. 12 bar (174 psi) differential the fluid flow path through the valve begins to open. The flow path opening then progressively increases, as the pressure is increased up to a level of approx. 30 bar (435 psi) differential, when the spool reaches the end of its travel. Further increase in pilot pressure (up to the maximum permissible) has no further effect on the output characteristics.

Good symmetrical characteristics for each direction of spool travel are achieved by using the same spring for each direction of spool travel.

Specially profiled metering notches on the spool give smooth, progressive opening/closing of the flow paths.

Vickers KDG3V valves offer ideal solutions for applications with repetitive load conditions, or where the load is under direct control of the machine operator.

### Functional Symbols

Transient flow conditions shown by dotted lines

Spool type 2C

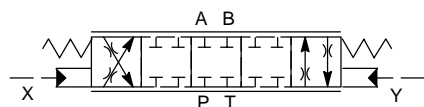

Spool type 33C

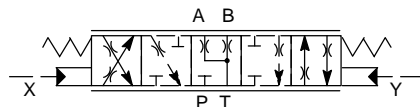

Spool type 133C, with typical regenerative circuit

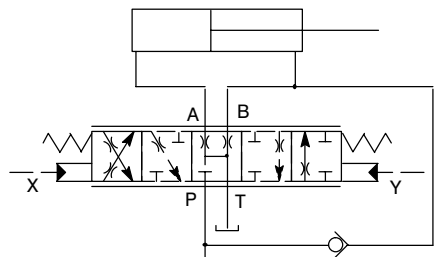

# Model Codes

**KDG3V - \* - \*\*\* C \*\*\* N (\*\*\*) - E - 1\***

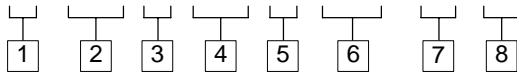

## 1 Mounting interface, ISO 4401

5 = Size 05  
7 = Size 07  
8 = Size 08

## 2 Spool type

See Functional Symbols, previous page.  
2 = All ports blocked when spool is centered  
33 and 133 = Bleed A and B to T when spool is centered

## 3 Spool control

C = Spool spring centered

## 4 Spool type

See adjacent table.  
Flow rating (L/min) for symmetric spools;  
"A" port flow rating for asymmetric spools

## 5 Spool type

See Functional Symbols, previous page.  
N = meter-in and meter-out

## 6 Spool type

See adjacent table.  
"B" port flow rating for asymmetric spools

## 7 Internal plug

E = Plug fitted

## 8 Design number, 1\* series

Subject to change. Installation dimensions unaltered for design numbers 10 to 19 respectively.

## Spool Types and Flow Ratings

Flow ratings for flow through P-A-B-T at  $\Delta p = 5$  bar (72 psi) per flow path, e.g. P-A or B-T. For other pressure drops see "Flow Gain" curves.

### Symmetric Spools

Spool code	Symbol	Flow rating
For KDG3V-5 valves:		
2C90N	2C	85 L/min (22 USgpm)
33C80N	33C	75 L/min (20 USgpm)
For KDG3V-7 valves:		
2C180N	2C	180 L/min (48 USgpm)
33C170N	33C	170 L/min (45 USgpm)
For KDG3V-8 valves:		
2C280N	2C	280 L/min (74 USgpm)
33C270N	33C	270 L/min (71 USgpm)

### Asymmetric Spools

Figure preceding metering type designator, "N" (e.g. 2C\*\*\*N) is "A" port flow rating, i.e. P-A, or A-T; figure after "N" (N\*\*\*) is "B" port flow rating, i.e. P-B or B-T.

Spool code	Symbol	Flow rating
For KDG3V-5 valves:		
2C70N45	2C	70 L/min (18.5 USgpm), "A" port flow 45 L/min (12 USgpm), "B" port flow
For KDG3V-7 valves:		
2C180N100	2C	180 L/min (48 USgpm), "A" port flow 100 L/min (26 USgpm), "B" port flow
For KDG3V-8 valves:		
33C250N170	33C	250 L/min (66 USgpm), "A" port flow 170 L/min (45 USgpm), "B" port flow
133C250N170	133C	250 L/min (66 USgpm), "A" port flow 170 L/min (45 USgpm), "B" port flow

# Operating Data

Data is typical with fluid at 36 cSt (168 SUS) and 50°C (122°F)

Max pressures, all ports: For KDG3V-5 For KDG3V-7/8	315 bar (4500 psi) 350 bar (5000 psi)
Pilot pressure for control	See below
Flow rating	See [4] and [5] in model code
Flow gain	
Power capacity envelopes	See below
Mass:	kg (lb)
KDG3V-5	8,2 (18)
KDG3V-7	10,2 (22.5)
KDG3V-8	18,9 (41.6)

## Power Capacity Envelopes

KDG3V-5/7/8 valves are not recommended for applications where flow/pressure drop is outside of these envelopes

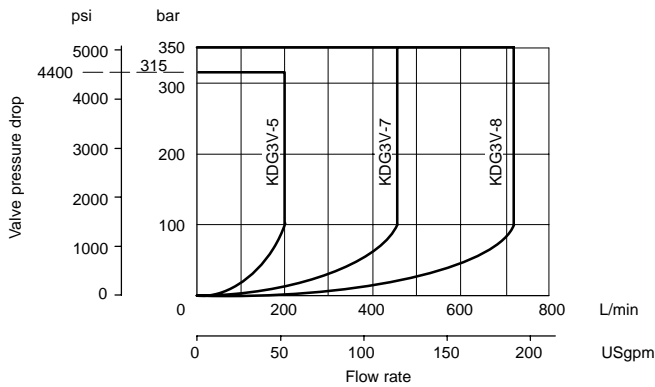

## Hydraulic Fluids

Materials and seals used in these valves are compatible with antiwear hydraulic oils, water-glycols, water-in-oil emulsions and non-alkyl-based phosphate esters. The extreme operating range is 500 to 13 cSt (2270 to 70 SUS) but the recommended running range is 54 to 13 cSt (245 to 70 SUS).

## Filtration Requirements

Recommendations on filtration methods and the selection of products to control fluid condition are included in Vickers publication 561 or 9132.

For products in this catalog the recommended fluid cleanliness levels are:

Up to 138 bar (2000 psi) . . . . . 17/15/12  
Above 138 bar (2000 psi) . . . . . 15/13/11

## Fluid Temperatures

For petroleum oil:

Min. . . . . -20°C (-4°F)

Max.\* . . . . . +70°C (+158°F)

\* To obtain optimum service life from both fluid and hydraulic system, 65°C (150°F) normally is the maximum temperature.

For other fluids where limits are outside those of petroleum oil, consult fluid manufacturer or Vickers representative. Whatever the actual temperature range, ensure that viscosities stay within those specified under "Hydraulic Fluids".

## Pilot Pressure for Control

Spool type 2C: \_\_\_\_\_

Spool types 33C and 133C: - - - -

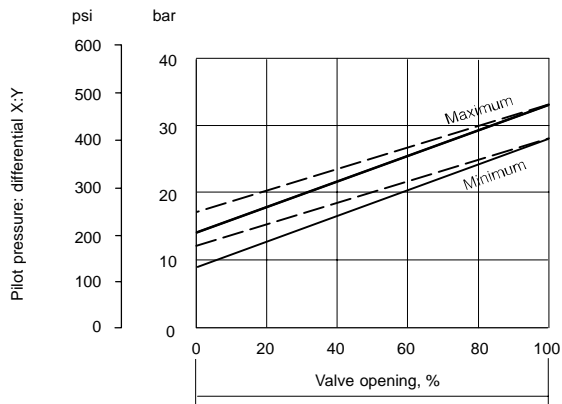

# Flow Gain Curves

**KDG3V-5-2C90N**

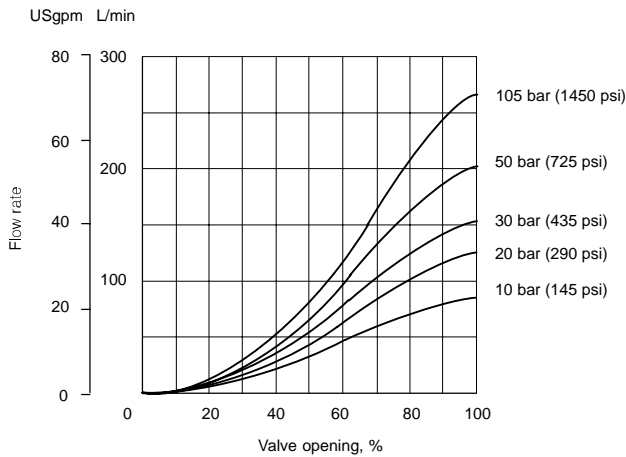

**KDG3V-5-33C80N**

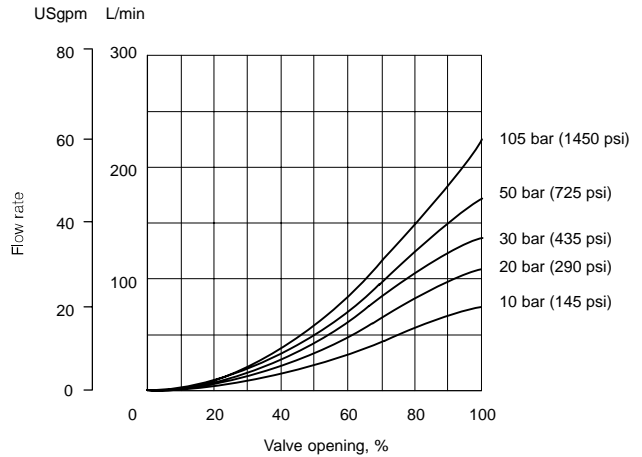

**KDG3V-7-2C180N**

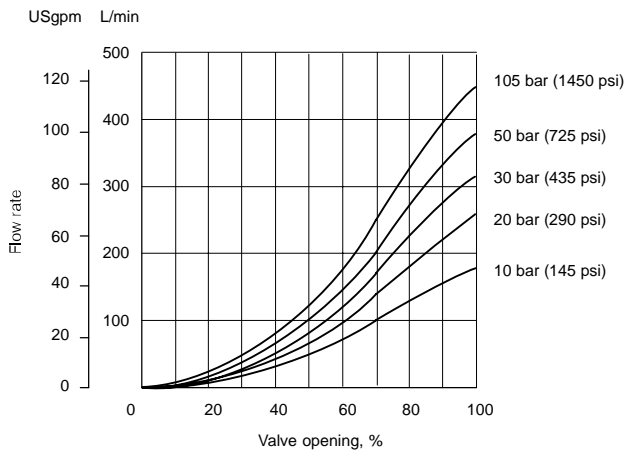

**KDG3V-7-33C170N**

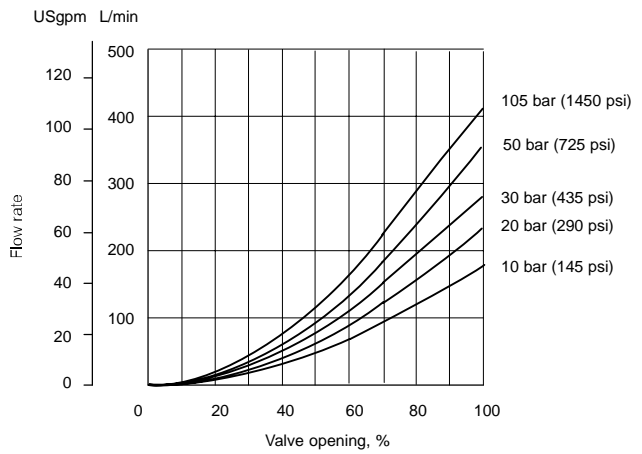

**KDG3V-8-2C280N**

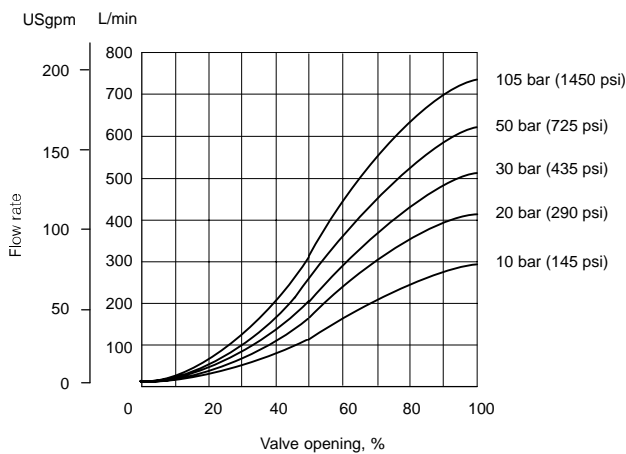

**KDG3V-8-33C270N**

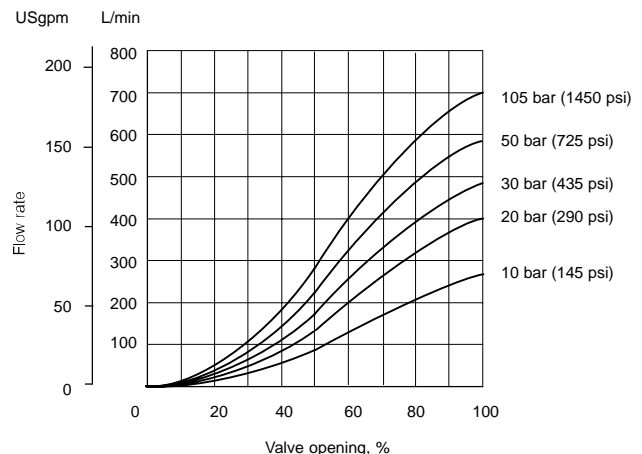

# Installation Dimensions in mm (inches)

## KDG3V-5

### Mounting Bolt Kits

Metric, M6 ..... BKDG01633M

Inch, 1/4"-20 UNC ..... BKDG01633

### Torque Data

Up to 210 bar (3000 psi)

..... 14 Nm (10.3 lbf ft)

Up to 315 bar (4500 psi)

..... 20 Nm (14.75 lbf ft)

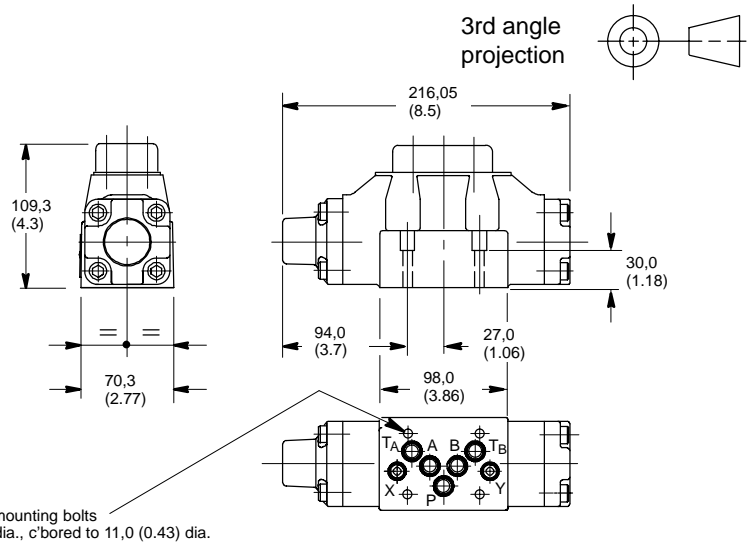

## KDG3V-7

### Mounting Bolt Kits

Metric, 4 x M10 plus 2 x M6

..... BKDG7858918

Inch, 4 x 3/8"-16 UNC plus 2 x 1/4"-20

UNC ..... BKDG01633

### Torque Data

M10; 3/8"-16 UNC ..... 49-59 Nm

..... (36-43lbf ft)

M6; 1/4"-20 UNC ..... 9-14 Nm

..... (6.6-10.3 lbf ft)

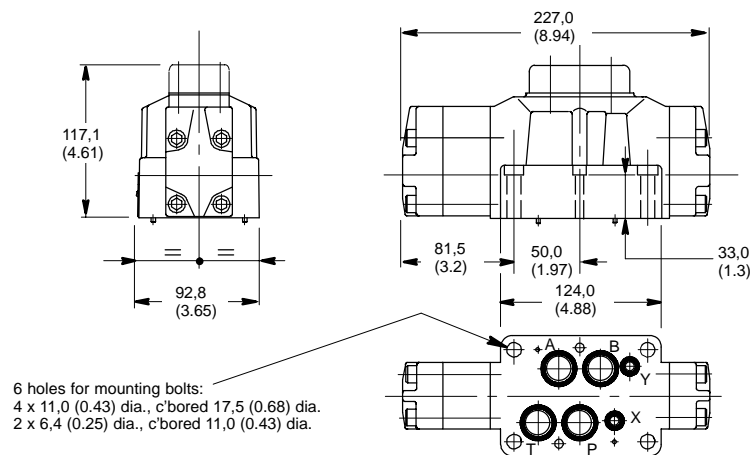

## KDG3V-8

### Mounting Bolt Kits

Metric, M12 ..... BKDG06635M

Inch, 1/2"-13 UNC ..... BKDG06635

### Torque Data

M12; 1/2"-13 UNC ..... 103-127 Nm

..... (76-93 lbf ft)

