

**Instructions for
Cutler-Hammer Type HWT-500
Network Protector
Portable Test Set**

**READ AND UNDERSTAND THESE INSTRUCTIONS BEFORE ATTEMPTING
ANY MAINTENANCE OF THE NETWORK PROTECTOR**

**SEE IMPORTANT DISCLAIMER OF WARRANTIES AND LIMITATION OF LIABILITY ON
NEXT PAGE**

Cutler-Hammer
2210 Highway 72/221 East
Greenwood SC 29649
Effective July, 2001

**DISCLAIMER OF WARRANTIES
AND LIMITATION OF LIABILITY**

THERE ARE NO UNDERSTANDINGS, AGREEMENTS, REPRESENTATIONS OR WARRANTIES, EXPRESSED OR IMPLIED, INCLUDING WARRANTIES OF MERCHANTABILITY OR FITNESS FOR A PARTICULAR PURPOSE, OTHER THAN THOSE SPECIFICALLY SET OUT BY AN EXISTING CONTRACT BETWEEN THE PARTIES. ANY SUCH CONTRACT STATES THE ENTIRE OBLIGATION OF SELLER. THE CONTENTS OF THIS DOCUMENT SHALL NOT BECOME PART OF OR MODIFY ANY PRIOR OR EXISTING AGREEMENT, COMMITMENT OR RELATIONSHIP.

The information, recommendations, descriptions and safety notifications in this document are based on Cutler-Hammer's experience and judgement with respect to the HWT-500 TEST SET. THIS INFORMATION SHOULD NOT BE CONSIDERED TO BE ALL-INCLUSIVE OR COVERING ALL CONTINGENCIES. If further information is required, Cutler-Hammer should be consulted.

NO WARRANTIES, EXPRESSED OR IMPLIED, INCLUDING WARRANTIES OF FITNESS FOR A PARTICULAR PURPOSE OR MERCHANTABILITY, OR WARRANTIES ARISING FROM COURSE OF DEALING OR USAGE OF TRADE, ARE MADE REGARDING THE INFORMATION, RECOMMENDATIONS, DESCRIPTIONS AND SAFETY NOTATIONS CONTAINED HEREIN. In no event will Cutler-Hammer be responsible to the user in contract, in tort (including negligence), strict liability or otherwise for any special, indirect, incidental or consequential damage or loss whatsoever including but not limited to damage to or loss of use of equipment, plant or power system, cost of capital, loss of profits or revenues, cost of replacement power, additional expenses in the use of existing power facilities, or claims against the user by its customers resulting from the use of the information, recommendations, descriptions and safety notations contained herein.

Please read instruction book I.B. 35-557 carefully before attempting to use the HWT-500.

Any questions regarding the HWT-500 Test Set or its instruction booklet may be answered by calling the Cutler-Hammer Network Protector toll-free number: 1-800-525-6821.

Failure to follow instructions contained within the instruction booklet and addendum could result in severe personal injury, death, and/or product or property damage and will void any warranties, expressed or implied.

These instructions do not purport to cover all possible contingencies that may arise during installation, operation, or maintenance, and all details and variations of this equipment. If further information is desired by purchaser regarding his particular installation, operation or maintenance of his equipment, the local Cutler-Hammer representative should be contacted.

<u>Table of Contents</u>	<u>Page</u>		<u>Page</u>
Introduction.....	4	<u>GENERAL ELECTRIC</u>	
Safety Information.....	5		
Test Set Transportation.....	6	Individual Relay Test.....	28
General Operating Information.....	7	CAN or CHN Master Relay Overvoltage Close Test.....	29
Control Panel Layout.....	8	CAN or CHN Master Relay Reverse Current Trip Test.....	30
Overall Operational Test.....	12	PYC16 Delayed-Sensitive Trip Test.....	31
Overall Close and Trip.....	14	CAL or CHL Phasing Relay Overvoltage Close Test.....	32
		SSNPR Close Test.....	33
<u>WESTINGHOUSE</u>		SSNPR Trip Test.....	34
		SSNPR Phase Detection Test.....	34
Individual Relay Test.....	16	Mechanism Components Test.....	36
CN-33 Master Relay Overvoltage Test.....	16	HWT-500 Maintenance and Repair.....	38
CN-33 Master Relay Reverse Current Trip Test.....	17	Table 1 - Suggested Relay Settings.....	39
CN-33 Single Phase Reverse Current Trip Test.....	19	Table 2 - Renewal Parts.....	41
CNJ Phasing Relay Overvoltage Test.....	20		
BN De-sensitizing Relay Time Delay Test.....	21		
BN De-sensitizing Relay Instantaneous Trip Test.....	22		
Mechanism Component Test.....	23		
MPCR Solid State Relay Close Test.....	26		
MPCR Solid State Relay Trip Test.....	27		
MPCR Solid State Relay Phase Detection Test.....	27		

INTRODUCTION

The Cutler-Hammer type HWT-500 universal, portable network protector test set has been designed for use on network protector breakers of all amperage ratings, 60HZ, and in the voltage class of 480 and 216.

It is designed for electrical and mechanical testing of any network protector breaker, or selected component parts, on voltages from 208Y/120 to 480Y/277 volts, three phase, four wire wye connected systems, or 480 volt, three phase, three wire delta systems.

The primary purpose of this test set is for routine testing of network protector breakers and calibration of network relays and electrical components in the field. However, if a network protector or a simulated network protector breaker is used with this test set, scales of the digital meters on the test set are such that network relays can be calibrated at a service center or laboratory.

NOTE

VOLTAGES AT SERVICE CENTERS OR LABORATORIES MAY NOT BE EQUIVALENT IN VOLTAGE MAGNITUDE OR VOLTAGE BALANCE BETWEEN PHASES AS COMPARED TO THE VOLTAGES FOUND IN MOST NETWORK LOCATIONS. MOST ELECTRO-MECHANICAL RELAYS ARE VOLTAGE SENSITIVE DEVICES WHOSE CALIBRATED SETTINGS CAN BE AFFECTED BY VARIOUS SYSTEM VOLTAGE LEVELS. DUE TO THIS FACT, WE STRONGLY RECOMMEND THAT THE FINAL RELAY CALIBRATION OF ELECTRO-MECHANICAL RELAYS BE PERFORMED USING THE SYSTEM VOLTAGE AVAILABLE AT EACH NETWORK PROTECTOR LOCATION. HOWEVER, SOLID STATE RELAYS ARE TYPICALLY NOT AFFECTED BY VOLTAGE FLUCTUATION AND ARE WELL SUITED FOR LABORATORY CALIBRATIONS.

SAFETY INFORMATION**WARNING**

- 1. FAILURE TO FOLLOW INSTRUCTIONS CONTAINED HEREIN COULD RESULT IN SEVERE PERSONAL INJURY, DEATH, AND/OR PRODUCT OR PROPERTY DAMAGE.**
- 2. ANY MECHANICAL OR ELECTRICAL MODIFICATION TO ANY NETWORK ROTECTOR REQUIRES THAT THE NETWORK PROTECTOR BE GIVEN APPROPRIATE ELECTRICAL TESTS, USING PROPERLY MAINTAINED TESTING DEVICES, BEFORE PLACING INTO SERVICE. FAILURE TO PERFORM SUCH ELECTRICAL TESTS CREATES CONDITIONS LEADING TO THE POSSIBILITY OF DEATH, SEVERE PERSONAL INJURY AND/OR PROPERTY DAMAGE.**

Keep this Instruction Book available to those responsible for the maintenance and operation of network protectors. It should be consulted before any procedures are performed.

The installation, testing and maintenance of a network protector present numerous potential unsafe conditions, including but not limited to, the following:

- Improper Operation
- Lethal Voltages
- Moving Parts
- Heavy Components

Specialized procedures and instructions are required and must be adhered to when working on such apparatus.

WARNING

AFTER THE TEST SET HAS BEEN COMPLETELY CONNECTED AND IS IN OPERATION, POTENTIALLY LETHAL VOLTAGES ARE PRESENT WITHIN THE NETWORK PROTECTOR BREAKER AND WIRING HARNESS OF THE UNIT UNDER TEST. ENERGIZED COMPONENTS ARE NOW EXPOSED.

PRIOR TO ENERGIZING THE NETWORK PROTECTOR BREAKER THROUGH THE TEST SET, THE OPERATOR MUST MAKE CERTAIN THAT OTHER PERSONNEL IN THE AREA MOVE A SAFE DISTANCE AWAY FROM THE UNIT UNDER TEST. FAILURE TO FOLLOW THESE WARNINGS MAY RESULT IN DEATH, SEVERE PERSONAL INJURY AND/OR PROPERTY DAMAGE.

BEFORE CONNECTING OR DISCONNECTING ANY OF THE TEST SET LEADS FROM THE BREAKER OR THE SUPPLY, MAKE CERTAIN THAT THE TEST SET RED SUPPLY SWITCH IS IN THE "OFF" POSITION.

TEST SET TRANSPORTATION

The HWT-500 test set is equipped with wheels and a retractable handle assembly to assist in the transportation of the device.

To extend the handle, slide the red handle lock located underneath retracted handle and extend the handle assembly outward.

End handles with spring returns are supplied on the main body of the unit. When lowering the HWT-500 into an underground vault, make certain that the rope or sling is attached to the main body end handle which is located on the same side as the retractable handle assembly. This keeps the wheels on the bottom end of the unit and aids in the balance of the unit when it comes to rest on the floor of the vault.

Likewise, when manually lifting the unit, always use the main body end handles.

DANGER

DO NOT ATTEMPT TO LOWER THE HWT-500 BY ATTACHING SLINGS OR ROPES TO THE RETRACTABLE HANDLE ASSEMBLY. TO DO SO MAY CAUSE THE RETRACTABLE HANDLE ASSEMBLY TO PERMANENTLY DISENGAGE RESULTING IN DEATH, SEVERE PERSONAL INJURY AND/OR PROPERTY DAMAGE.

USE ONLY THE END HANDLE OF THE MAIN BODY OF THE UNIT LOCATED ON THE SAME END AS THE RETRACTABLE HANDLE ASSEMBLY.

The test set cover is secured to the main body of the unit with four over-toggle suitcase latches.

To return the handle into the case, slide the red handle lock and push the retractable handle into the body of the case.

GENERAL OPERATING INFORMATION**WARNING**

ANY MECHANICAL OR ELECTRICAL MODIFICATION TO ANY NETWORK PROTECTOR REQUIRES THAT THE NETWORK PROTECTOR BE GIVEN APPROPRIATE ELECTRICAL TESTS, USING PROPERLY MAINTAINED TESTING DEVICES, BEFORE PLACING INTO SERVICE. FAILURE TO PERFORM SUCH ELECTRICAL TESTS CREATES CONDITIONS LEADING TO THE POSSIBILITY OF DEATH, SEVERE PERSONAL INJURY AND/OR PROPERTY DAMAGE.

1. The Type HWT-500 test set is equipped with selector switches and controls to vary both the overvoltage phasing value as well as the reverse current magnitude at various preselected angles. Refer to pages 8-10 regarding the control panel layout and description of the controls.
2. The HWT-500 is equipped with a single lamp PHASE SEQUENCE indicator that becomes energized when the supply cables are attached to an energized voltage source, and the supply switch is at the 216 or 480V. This permits immediate verification of the correct sequence. An illuminated lamp indicates that the system sequence is incorrect. Periodically check the lamp by purposely connecting the input supply leads incorrectly.
3. An electrical interlock is built into the HWT-500 that prevents the possibility of 480 volts entering the test set when the SUPPLY switch is in the 216 position. Moving the red SUPPLY switch to the 216 position when 480 volt potential is present at the supply leads of the test set will result in the electrical shutdown of the test set.
4. The position of the SUPPLY switch (480 or 216) refers to the system voltage of the network protector being tested. The 216 position is to be used with network voltages up to 216 volts that are either wye or delta connected. The 480 position is to be used with network voltages of 480 volts that are either wye or delta connected. A protector used on 480-volt systems may or may not utilize 480-volt class relays. Regardless of the fact, all 480-volt network protectors are to be tested with the red SUPPLY switch in the 480 position.

CAUTION

ON DELTA SYSTEMS THE TEST SET LEADS MARKED NEUTRAL MUST BE CONNECTED TO AN EARTH GROUND FOR CORRECT OPERATION OF TEST SET CIRCUITS. ON WYE CONNECTED SYSTEMS BOTH THE NETWORK PROTECTOR ENCLOSURE AND THE NETWORK PROTECTOR BREAKER MUST BE GROUNDED.

5. Before any testing shall commence, the network protector breaker must be in the disconnected and rolled out position, with the main breaker contacts in the OPEN position. Proceed to connect the test control cables to the test set and to the network protector.

Insure that the SUPPLY switch is placed in the "OFF" position. Connect the SUPPLY LEADS to the source voltage. Check that the PHASE SEQUENCE indicator light is "OFF" indicating that the sequence input is correct. Using the SUPPLY VM switch, a check of the input supply voltages should be made to insure that the input supply is balanced, both phase-to-phase and phase-to-ground.

6. The HWT-500 controls the phasing volts and reverse current through the use of the three phase VARIAC.

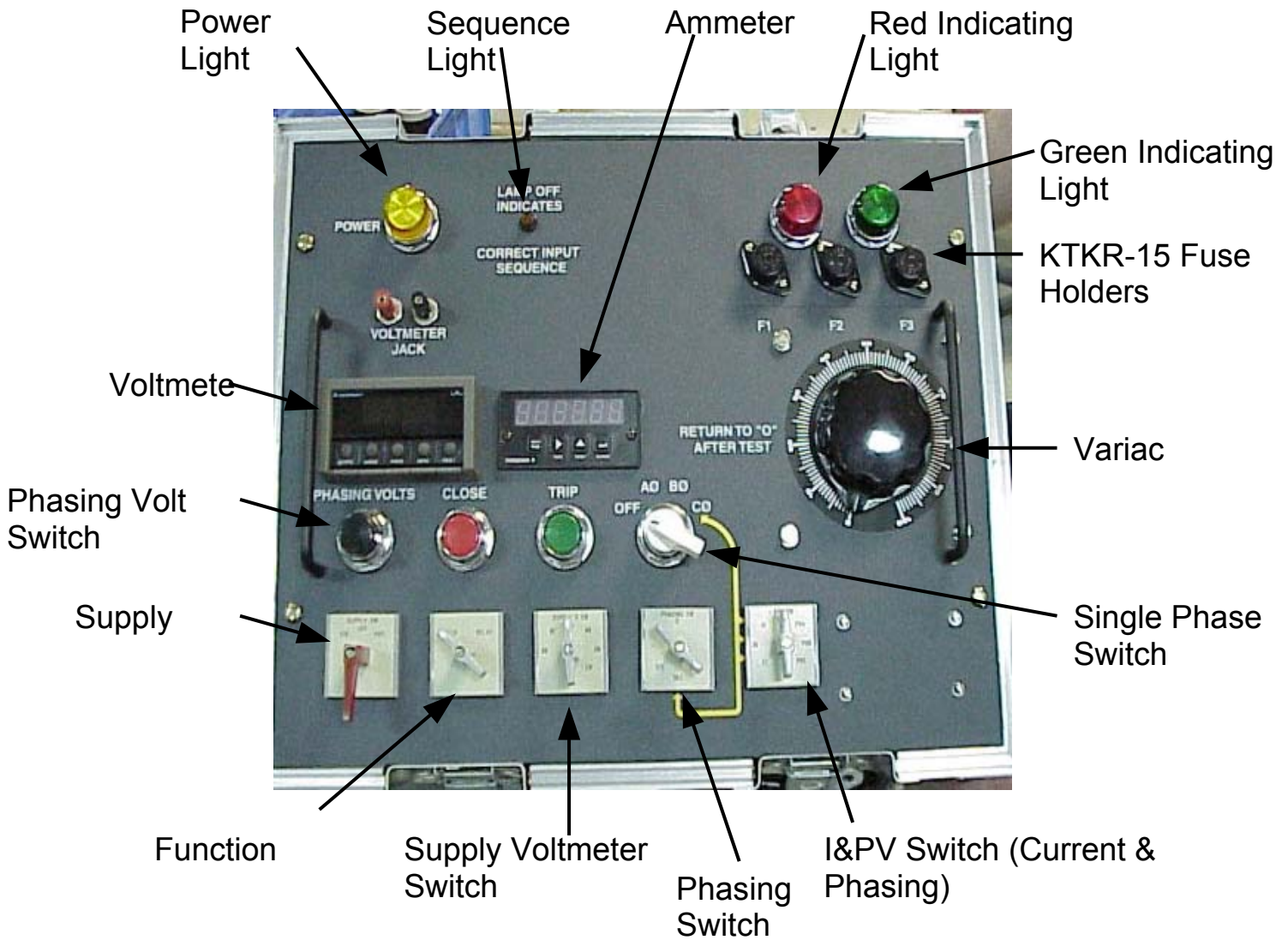

DANGER

IT IS VERY IMPORTANT TO RETURN THE VARIAC TO “0” AFTER THE COMPLETION OF EACH OPERATION. FAILURE TO FOLLOW THIS WARNING WILL RESULT IN DAMAGE TO VARIAC INSULATION.

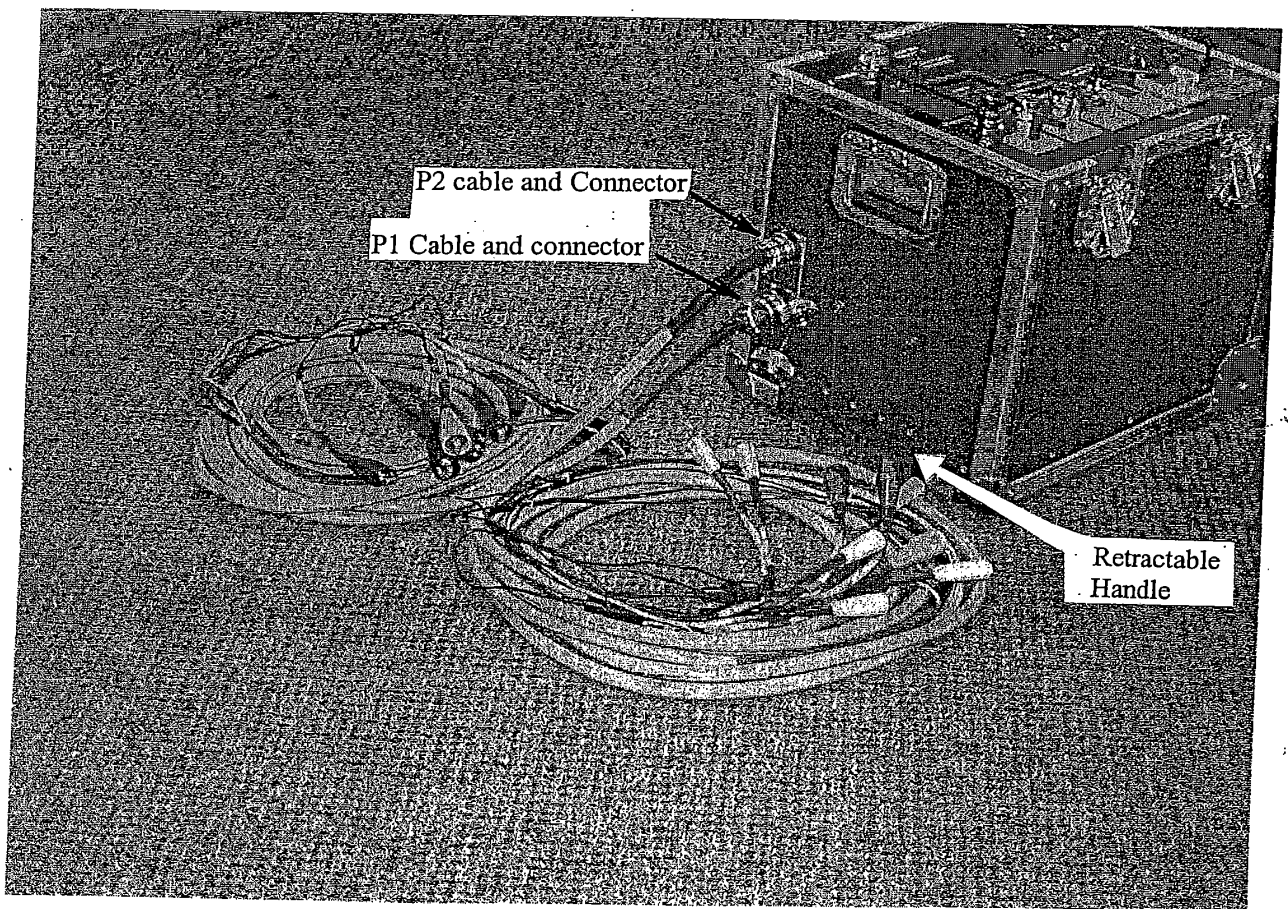

P1 and P2 Cable Assemblies

DESCRIPTION OF CONTROLS

P1 and P2 – Cable Input Sockets

NOTE – They are polarized and have a different contact arrangement. Dust covers with lanyards are supplied.

F1, F2, F3 – Test kit fuses, Type KTKR-15.

POWER ON LIGHT – Is illuminated when the supply switch is moved from the “OFF” position to either the 480 or 216 position.

SUPPLY SWITCH – Marked “216-OFF-480”, should be moved only after all the cable connections are complete and set to the correct system voltage at the time of testing.

AMMETER – This digital meter shows the reverse current trip value.

VOLTMETER – The digital voltmeter reads system voltage determined by the position of the Supply Voltmeter Switch. It also reads phasing volts if the phasing volt selector switch is in the ON position and the I & PV switch is in any one of the PV (A, B, C) selections. NOTE – both digital meters, upon power-up, go through an initializing sequence that can take several seconds to complete.

The red and green indicator lights are used in conjunction with the “COMM-RED-GREEN” marked leads. These are intended to be used with dry contacts.

WARNING

DO NOT USE THE LEADS MARKED “COMM-RED-GREEN” ON ENERGIZED CIRCUITS.

PHASING SWITCH – determines the phasing voltage phasor angle with respect to the network voltage in the “0” and “60” degree position. It also determines the reverse current angle with respect to the individual phase voltage at either “120”, “180” or “240” degree position.

TEST SWITCH – Relay position is used to test and calibrate network protectors with relays. The Mech position is used in the mechanical test without relays.

SUPPLY VOLT SWITCH – will monitor the system voltage. It is also used in the mechanical mode to select either phase-to-phase or phase-to-ground connections.

VARIAC – is used to set the various voltages either phase-to-phase or phase-to-ground during both mechanical testing and voltage as well as current in the Relay mode.

PHASING VOLT SWITCH – in the ON position permits phasing volts to be displayed on the voltmeter. In the OFF position will display the system voltage determined by the Supply Voltmeter Switch position. It should be in the OFF position for all MECH tests.

Output Cable Assemblies

30 Foot Cable Assembly for Socket P2

A-B-C.....Supply leads with in-line KTKR-30 fuses
* COMM-RED-GREEN.....Red and Green indicating lamp leads
COMM-CLOSE-TRIP.....Mechanical Test leads
N (GRD).....Housing neutral or ground lead

30 Foot Cable Assembly for Socket P1

NA-NB-NC.....Network side breaker leads
TA-TB-TC.....Transformer side breaker leads
N (GRD).....Breaker neutral or ground lead

WARNING

DO NOT USE THE LEADS MARKED “COMM-RED-GREEN” ON ENERGIZED CIRCUITS.

PROCEDURE FOR OVERALL OPERATIONAL TEST

Before commencing work, refer to Safety Information.

Using Cutler-Hammer Type HWT-500 test Set on a 216Y/125 volt, 3 phase, 4-wire system with solid state relays. Refer to figure on page 14 for the required test lead connections.

This test will determine if the network protector, as a whole, is operating correctly. The test consists of two parts; an overall close test and an overall tripping test.

1. Roll the removable breaker out of its enclosure to the test and inspection position.

CAUTION

REFER TO THE PROPER INSTRUCTION BOOK FOR THE NETWORK PROTECTOR UNDER TEST FOR THE CORRECT PROCEDURE TO DE-ENERGIZE AND ROLL THE REMOVABLE BREAKER OUT TO ITS TEST AND INSPECTION POSITION.

2. Attach test cable P1 and P2 to the test set.
3. Inspect and check that the SUPPLY switch is in the "OFF" position and that the VARIAC is turned to the "OFF" position.
4. Connect the Network side test leads to the removable breaker. These leads are marked NA, NB, and NC.
5. Connect the Transformer side test leads to the removable breaker. These leads are marked TA, TB, and TC.
6. Connect the Neutral (ground) lead to a ground point on the rollout unit.
7. Connect the Neutral (ground) lead to a suitable grounding point inside the network protector enclosure.
8. While wearing electrical insulating gloves, connect the test set SUPPLY LEADS to the network side terminals inside the protector enclosure.
9. Set the removable breaker to the automatic position.
10. Place the Relay Type Switch in the "RELAY" mode.
11. Place the I & PV Switch in any one of the PV (A, B, or C) positions.
12. Place the Phasing Switch to the 0 degree position.
13. Place the Supply Switch to the "216" position.
14. Inspect that the Power light is illuminated and that both the Ammeter and Voltmeter are functioning.
15. Inspect the Phase Sequence Indicating Light and ensure that it is **NOT** illuminated.

16. Rotate the Supply Voltmeter switch checking all phase-to-phase and phase-to-ground voltages. Return the Supply Voltmeter to the CA position.
17. Rotate the Phasing Volts Switch to the "ON" position.
18. Confirm that the breaker main contacts are open.
19. Turn the VARIAC knob clockwise to slowly increase the phasing volts. When the protector closes observe the value of the phasing volts and return the VARIAC to the zero position.

NOTE: The voltmeter requires some time to adjust to lower voltage inputs. Please adjust the voltmeter slowly when measuring small values of phasing volts. You will also note that because of residual non-zero voltage across the VARIAC the voltmeter does not register true zero volts.

20. With the protector closed you are now ready to perform a reverse current trip test.
21. Rotate the Phasing Volt switch counterclockwise to its "OFF" position.
22. Place the Phasing Switch to the 180-degree position.
23. Place the I & PV Switch to any one of AI, BI or CI positions.
24. Turn the VARIAC knob clockwise to slowly increase the reverse current. When the protector trips observe the value of the trip current on the Ammeter and return the VARIAC to the zero position.
25. If the network protector relay is found to be within your specified calibration you can proceed to the Mechanical Component Test (Cutler-Hammer on page 23, General Electric on page 36). The mechanical tests are performed to ensure that the motor, tripping device and intermediate motor control device are operating at the minimum pick-up voltages.

NOTE: Because of the ruggedness of the HWT-500 design and the components selected, it is possible to perform crossed phase, rolled phase and shorted phase tests using this device so long as the breaker main contacts are in the open position and motor closing has been blocked. Unintentional closures under these conditions will clear the 15 amp fuses located on the front panel of the test set.

NOTE: The electrical interlock produces a noticeable hum in the 216 volt position and is a normal condition of operation.

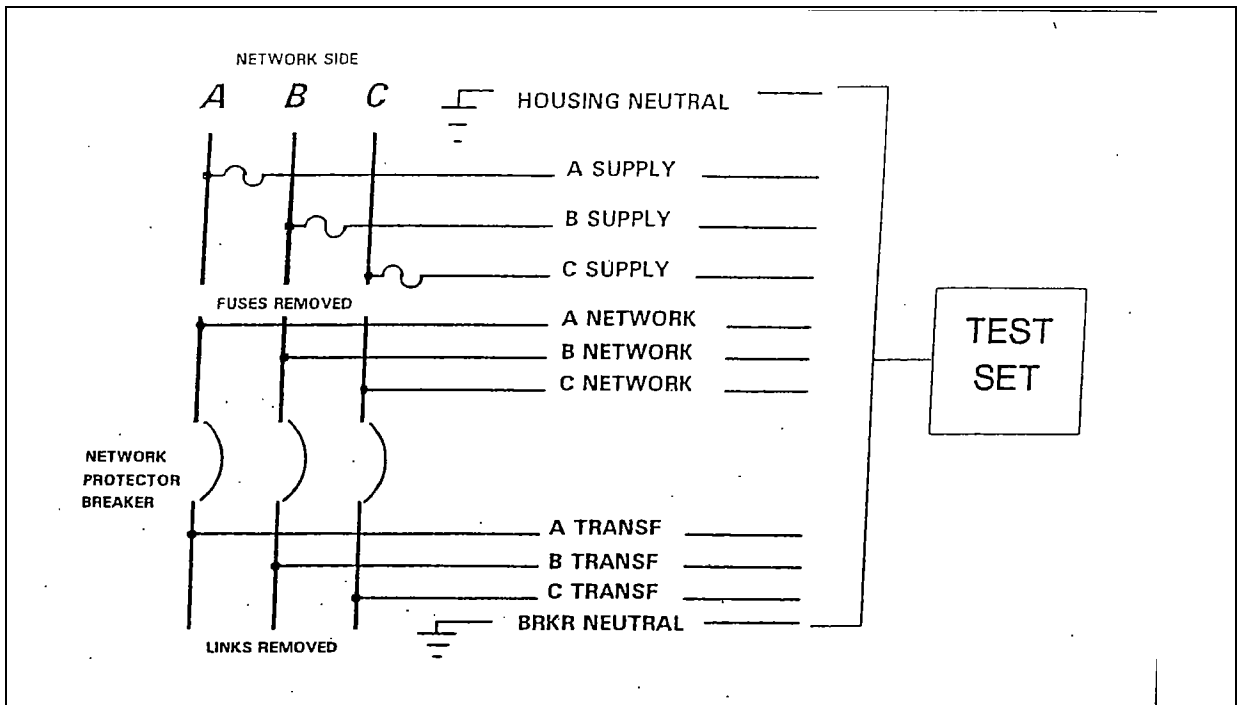
OVERALL CLOSE AND TRIP TEST CONNECTION

Before commencing work, refer to the Safety Information.

Close Test – Switch positions

Network protector open and set for automatic operation

FUNCTION Switch – “RELAY” position

I & PV Switch – PVA position

Supp VM Switch – CA position

PHASE switch – 60 position

Single PH Test Switch – OFF position

PHASING volt switch – ON position VARIAC – zero position

SUPPLY Switch – 216 or 480 position depending on network system voltage

By increasing the VARIAC'S position, you can increase the overvoltage phasing value to the desired value or to that value at which the network protector breaker will close its main contacts. The network protector breaker should be closed several times to ensure that the operation is consistent.

Trip Test – Switch positions

Network protector closed and set for automatic operation

FUNCTION Switch – “RELAY” position

I & PV Switch – AI position

Supp VM Switch – CA position

PHASE switch – 180 position

Single PH Test Switch – OFF position

SUPPLY Switch – 216 or 480 position depending on network system voltage

VARIAC – zero position

By increasing the VARIAC'S position, you can increase the reverse current value to the desired value or to that value at which the network protector breaker will open its main contacts. The network protector breaker should be tripped several times to ensure that the operation is consistent.

When making the overall tripping test on a network protector breaker equipped with an electro-mechanical de-sensitizing relay, connections to the test set, network protector breaker, and power source as well as the switch positions remain the same. The reverse current is slowly increased from zero until the relay trip contact makes. This is the reverse current required to trip the breaker. As soon as the master relay trip contact makes, the timing cycle of the time delay relay begins and the timing cycle is completed when the breaker trips.

NOTE: When using the Type MPC series of solid state relays having a time delay setting, the reverse current should be adjusted somewhat higher than its setting to ensure that the trip logic is initiated. Timing should begin after the trip set point has been exceeded on the Ammeter.

INDIVIDUAL RELAY TEST

Westinghouse Electro-Mechanical Type CN-33, CNJ, BN. Before commencing work, refer to the Safety Information.

These tests determine if the relays on a network protector breaker, CN-33 master relay, CNJ phasing relay and the BN de-sensitizing relay are functioning properly and their setting in regard to overvoltage close, reverse current trip, time delay and instantaneous trip, is correct.

The test lead connection to the network relay terminals are made by backing out the terminal screws which correspond to the relay contact structure until the second machined head appears. This will permit the attachment of one of the alligator clip leads marked "COMM-RED-GREEN" to the exposed end of the terminal screw. In the case of the type BN relay, the front steel cover of the relay must be removed before the relay terminal screws are accessible. When the relay terminal screw is backed out, the contact between the relay terminal screw and the network protector breaker wiring is broken, but the contact between the relay terminal screw and the internal wiring of the relay continues to remain intact.

Switch Positions

Network Protector open, breaker does not have to be in automatic mode.

FUNCTION Switch – "RELAY" position I & PV Switch – PVA position

Supp VM Switch – CA position PHASE switch – 0 position

Single PH Test Switch – OFF position PHASING volt switch-ON position

SUPPLY Switch – 216 or 480 position depending on network system voltage

VARIAC – zero position

By increasing the VARIAC'S position, you can increase the in phase (zero degrees) overvoltage phasing value to the desired overvoltage close value. The CN-33 relay overvoltage setting may be adjusted through the use of a narrow blade screwdriver inserted in the overvoltage adjustment screw located to the left side of the front bearing. Adjustment should be made until the red indicator light is illuminated.

When making the CN-33 relay overvoltage close test on a 216-volt relay being used on a 480 volts system the phasing voltage necessary to close the relay is not directly indicated on the Voltmeter. The relay calibration on this system is determined by dividing the voltmeter reading by 2.2. However, the suggested settings as listed in this manual are those that would be directly indicated by the voltmeter.

The overvoltage setting of a CN-33 master relay must be made first since it is made by means of a spiral spring fastened to the moving contact of the relay and will therefore affect the reverse current setting of the relay. The BN de-sensitizing relay, BN dummy plate, or BN jack plate must be present to complete the current coil circuits. This is necessary to provide the correct mutual impedance for the CN-33 master relay phasing coils. The CN-33 master relay current and phasing coils are wound on the same core.

A test voltage continuously variable from zero to fifteen volts is available for this test.

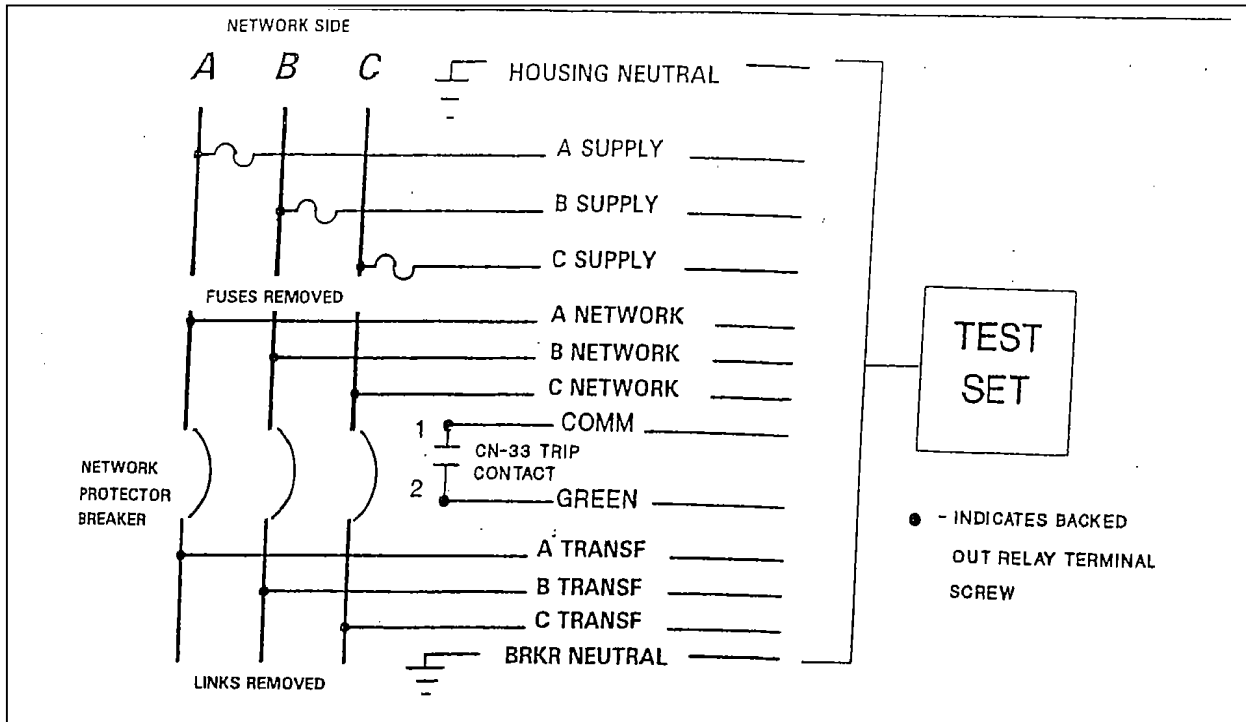
CN-33 MASTER RELAY REVERSE CURRENT TRIP TEST

Before commencing work, refer to the Safety Information.

Switch Positions

Network protector closed, breaker does not have to be in the automatic mode.

FUNCTION Switch – “RELAY” position

I & PV Switch – AI position

Supp VM Switch – CA position

PHASE switch – 180 position

Single PH Test Switch – OFF position

SUPPLY Switch – 216 or 480 position depending on network system voltage

VARIAC – zero position

By increasing the VARIAC'S position you can increase the reverse current value to the desired reverse current value. The CN-33 master relay reverse current adjustment screw is designed to interface with a series of three leaf springs hung below the moving contact assembly. By increasing or decreasing the spring deflection will increase or decrease the trip setting.

WARNING

THE REVERSE CURRENT ADJUSTMENT SCREW MAY BE ENERGIZED. ANY ADJUSTMENT SHOULD BE MADE WITH THE TEST SET SUPPLY SWITCH IN THE "OFF" POSITION. MAKE YOUR ADJUSTMENT THEN RE-ENERGIZE THE NETWORK PROTECTOR BREAKER THROUGH THE SUPPLY SWITCH ONCE ALL TOOLS HAVE BEEN REMOVED. FAILURE TO FOLLOW THESE INSTRUCTIONS COULD LEAD TO DEATH, SEVERSE PERSONAL INJURY AND/OR PROPERTY DAMAGE.

The GREEN indicator lamp will illuminate when the CN-33 trip contact makes. When this test is performed the BN de-sensitizing relay, the BN dummy plate, or the BN jack plate must be present to complete the current coil circuits.

CN-33 SINGLE PHASE REVERSE CURRENT TESTS

Before commencing work, refer to the Safety Information.

Switch Positions

Network protector closed, breaker does not have to be in the automatic mode.

FUNCTION Switch – “RELAY” position I & PV Switch – AI, BI, CI position

Supp VM Switch – CA position PHASE switch – 180 position

Single PH Test Switch – A, B, C – must correspond to I & PV sw position

SUPPLY Switch – 216 or 480 position depending on network system voltage

VARIAC – zero position

This test requires that a BN dummy plate or BN jack plate be placed in the position of the BN de-sensitizing relay.

Having previously determined the three-phase current trip value for the CN-33 master relay, the single-phase value is determined by

1. Select the phasing switch to the 180-degree position.
2. Select the I & PV switch to the desired phase for current, e.g. AI, BI, or CI position.
3. Rotate the black handle of the single-phase selector switch from the OFF position to A phase, or the same phase as selected on the I & PV switch.
4. Increase the VARIAC until the relay calls for a trip.

The typical single-phase values should be approximately three times the nominal three-phase setting. For example, if your nominal three phase reverse current setting is 3.2 amps, then the single-phase value should be approximately 9.6 amps.

You would repeat this test by changing the position of the I & PV switch as well as the single-phase selector switch, ensuring that the I & PV selection matched the phase selected on the single-phase selector switch. Repeat the reverse current test to cover all three phases.

Errors in current transformers (shorted turns or open windings) or errors in current transformer external harness connections (reverse polarity) can be detected by use of this test. However, nominal deviations of 5 percent can be expected in phase-to-phase comparisons.

When completed with the single phase testing, ensure that the single-phase test switch is turned to the “OFF” position.

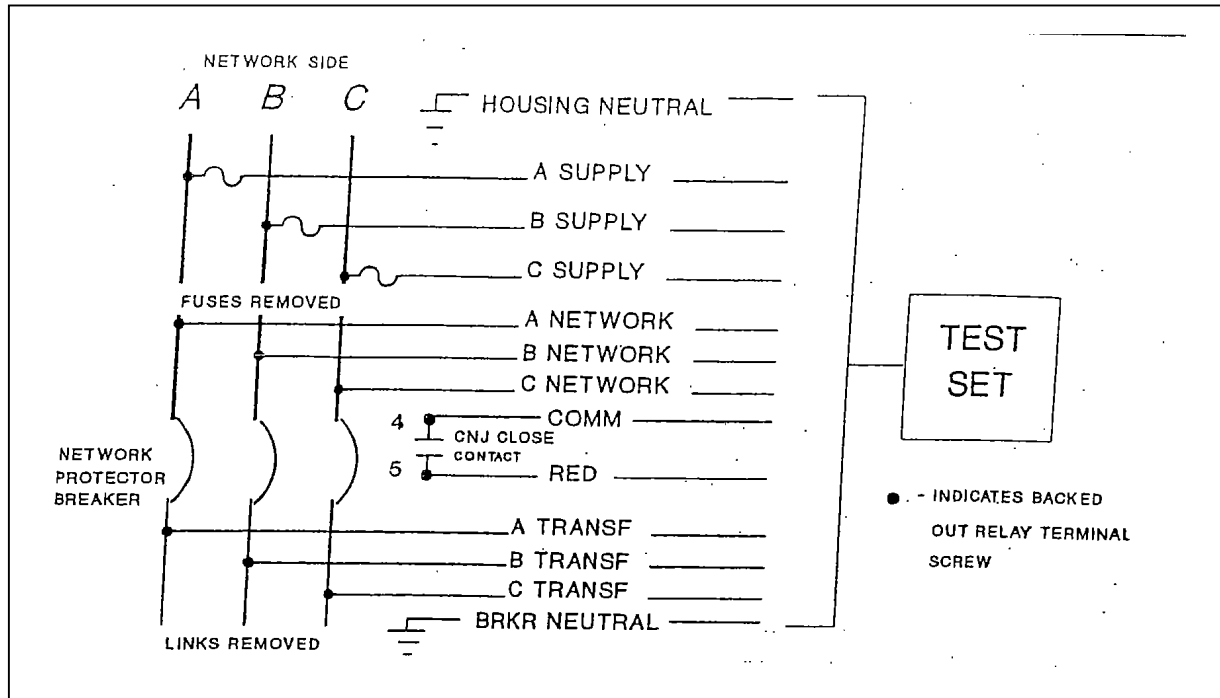
CNJ PHASING RELAY OVERVOLTAGE CLOSE TEST

Before commencing work, refer to the Safety Information.

Switch Positions

Network protector closed, breaker does not have to be in the automatic mode.

FUNCTION Switch – “RELAY” position I & PV Switch – PVA position

Supp VM Switch – CA position PHASE switch – 60 position

Single PH Test Switch – OFF VARIAC – zero position

PHASE volt switch – ON position

SUPPLY Switch – 216 or 480 position depending on network system voltage

By increasing the VARIAC'S position you can increase the overvoltage phasing value to the desired overvoltage close value. The CNJ relay overvoltage setting may be adjusted through the use of a narrow blade screwdriver inserted in the overvoltage adjustment screw located to the left side of the front bearing. Adjustment should be made until the red indicator light is illuminated.

It is important that the CNJ relay contact is open at zero phasing volts and closes its contact at your predetermined overvoltage close value. This will ensure that a positive value of phasing volts is required to close the contact. Otherwise, and incorrectly set phasing relay may permit the network protector breaker to close on lagging phasing voltage which, in turn, can cause the breaker to rapidly open and close its contacts. The CNJ phasing relay is generally set to close at 0.5 to 2.0 volts at 60 degrees when closing characteristic curves number 6, 7, 8 or 9 are used. Curve number 6, 7, 8 and 9 refer to the CNJ terminal number. Three dust cover screws (black color) and one live screw (nickel-plated) are located in these four positions. The curve is chosen by inserting the live screw into one of the four locations and filling the remaining locations with the three dust cover screws. Unless otherwise specified, characteristic curve number 8 (-5 degree slope) is supplied from the factory.

BN DE-SENSITIZING RELAY TIME DELAY TEST

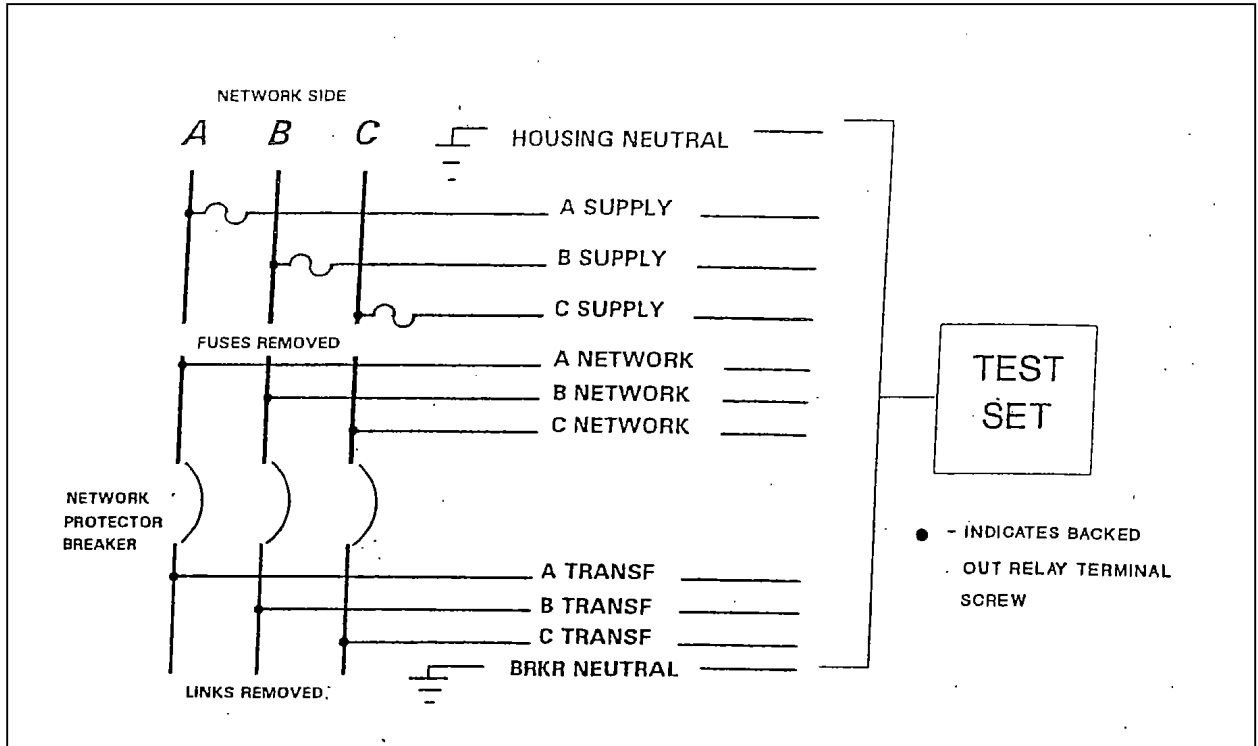

Before commencing work, refer to the Safety Information.

Switch Positions

Network protector closed, breaker does not have to be in the automatic mode.

FUNCTION Switch – “RELAY” position

I & PV Switch – PVA position

Supp VM Switch – CA position

PHASE switch – 180 position

Single PH Test Switch – OFF

VARIAC – zero position

SUPPLY Switch – 216 or 480 position depending on network system voltage

BN DE-SENSITIZING RELAY TIME DELAY TEST

With the full compliment of relays in place (CNJ, CN-33 & BN), rapidly increase the reverse trip value above the nominal CN-33 trip value. Start the timing of the BN the moment the CN-33 trip contacts make. Stop the timing cycle when the breaker opens it main contact.

MECHANISM COMPONENT TESTS

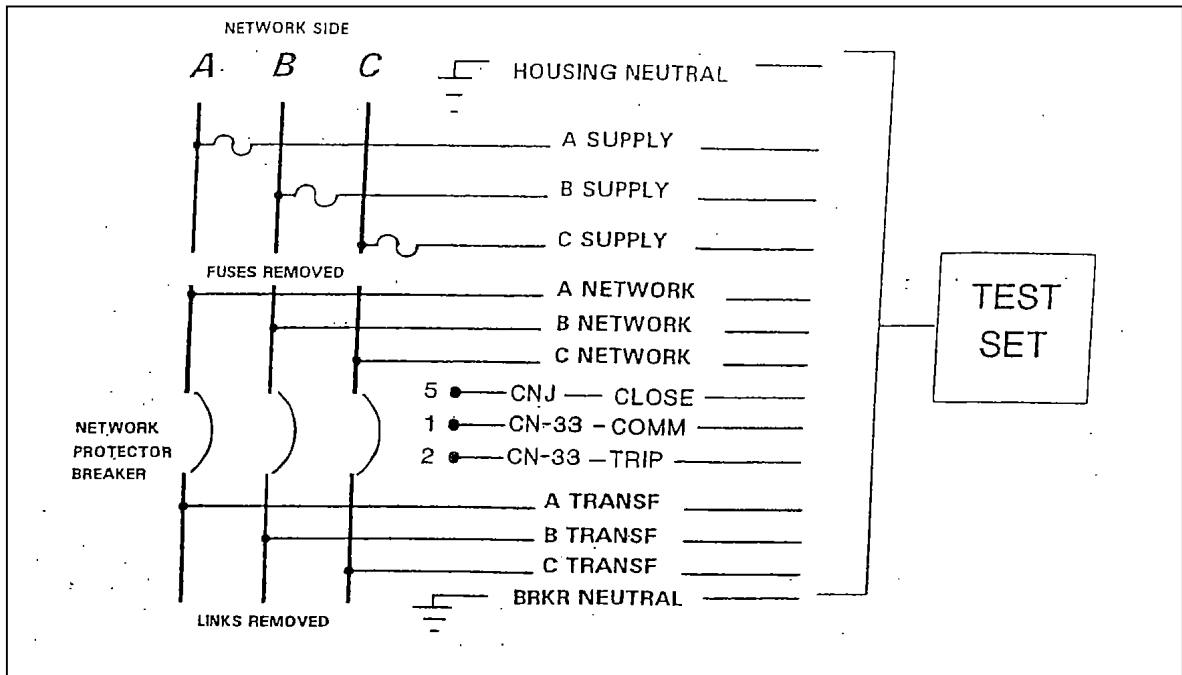

Before commencing work, refer to the Safety Information.

Switch Positions

Network protector open and set for automatic operation with the relays removed.

FUNCTION Switch – “MECH” position

I & PV Switch – AI position

Supp VM Switch – CA position

PHASE switch – 0 position

Single PH Test Switch – OFF

VARIAC – zero position

PHASE volt switch – OFF position

SUPPLY Switch – 216 or 480 position depending on network system voltage

In this test, voltage is controlled by the variable autotransformer. Before commencing the test, remove the BN relay (if applicable) and replace it with a BN dummy or jack plate assembly. You must know the general breaker wiring configuration for the motor close and trip circuits. For example, you must know whether the motor is connected phase-to-phase or phase-to-ground as well as the trip device. This information can best be obtained from the wiring diagram of the network protector breaker under test.

For mechanical closing operation the Supply VM switch should be in the CA position and should read near zero potential with the VARIAC at zero. This is based on breakers that have the closing motor wired C to A phase and the reading on the VOLTMETER reflects voltage applied between cable terminal TC and TA. Closing values for both line-to-line and line-to-neutral wired breakers are indicated on the charts located on page 24.

By turning the VARIAC control knob clockwise, increase the voltage displayed on the VOLTMETER. Set the voltage to the minimum close level and depress the red (close) push button. The breaker must close its contacts at the minimum voltage level. Return the VARIAC to the zero position.

The network protector breaker failing to close or trip during these minimum voltage series of tests can indicate a mechanism or trip device that needs immediate attention. Records should be made of the minimum voltage values so that a year-to-year comparison can be made. Slow deterioration of the motor or trip device can be observed over the years by making such comparisons. Pin pointing such problems in advance can lead to lower maintenance costs over the life of the equipment.

Rated Voltage	L-L Or L-G	Control Relay 80-106%	Closing Motor 78-106%	Tripping Voltage 7.5-106%
125/216	L-L	170-230	157-230	16-230
277/480	L-G	220-295	200-295	36-510 *
277/480 or 480	L-L	385-510	350-510	36-510
* Trip coil connected L-L				

**THIS
PAGE
IS
BLANK**

MPCR or MPCV SOLID RELAY TEST

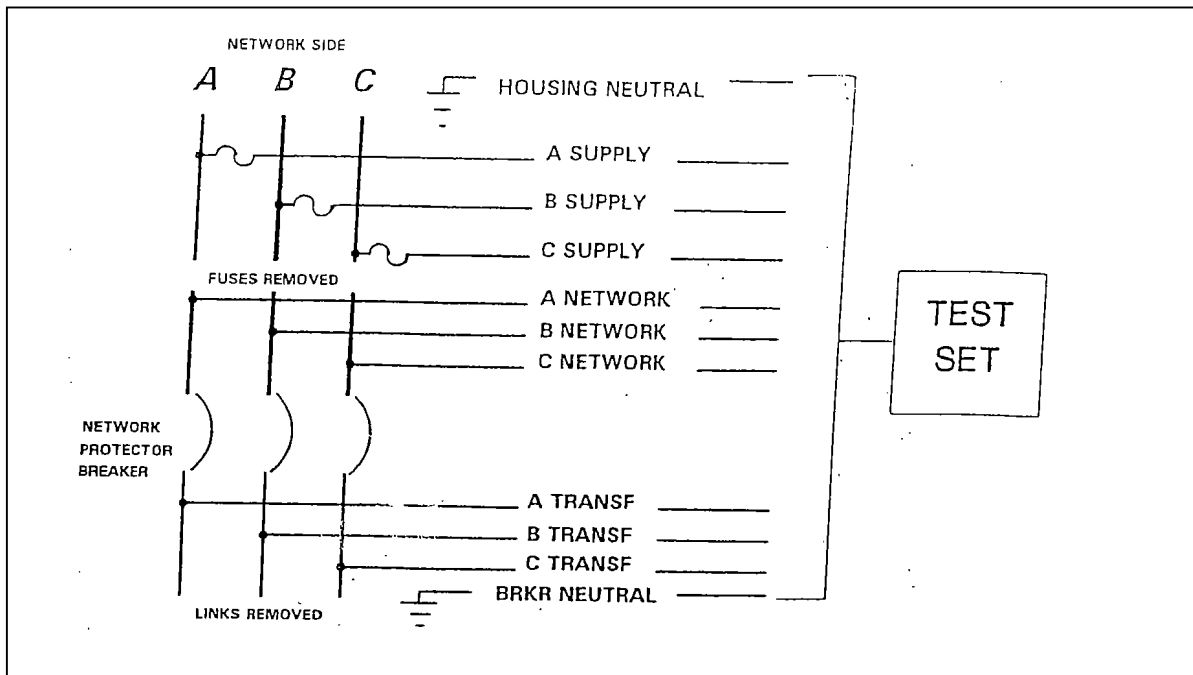

Before commencing work, refer to the Safety Information.

Switch Positions

Network protector open and set for automatic operation.

FUNCTION Switch – “RELAY” position

I & PV Switch – PVA for close, AI for trip

Supp VM Switch – CA position

PHASE switch – 0 for close, 180 for trip

Single PH Test Switch – OFF

VARIAC – zero position

PHASE volt switch – ON position

SUPPLY Switch – 216 or 480 position depending on network system voltage

When the SUPPLY switch is rotated to either the 216 or 480 position (depending on the network system voltage) the MPCR power circuits will be initiated and the MPC indicating lights should sequentially turn ON.

WARNING

DO NOT functionally operate (trip and close) the network protector breaker with the setting pendant connected into the RS-232 port. Calibration of the MPCR or MPCV Relay must be made with three-phase potential and only after the FLOAT light is illuminated. At the end of the calibration sequence the pendant must be removed prior to operation of the breaker.

Close Test

By rotating the VARIAC you can increase the overvoltage phasing value to the desired value at which the MPCR CLOSE light becomes illuminated. The network protector breaker will then close its main contacts. Note, the MPCR or MPCV CLOSE light will remain illuminated for approximately 4 seconds during which time the network protector breaker must close its main contacts. After the 4-second interval the FLOAT light will again be illuminated. The network protector breaker should be closed several times to ensure that the operation is consistent. Also note that the calibration and testing of the MPCR or MPCV is performed “in phase” or at zero degrees.

Trip Test

All of the switch positions remain the same as used in the "Close Test" with exception of the Phasing switch and the I&PV switch which must be changed to the 180 position and the AI position, respectively. The network protector must be closed.

By rotating the VARIAC you can increase the reverse current value to the desired value at which the MPC TRIP light becomes illuminated. The network protector will then open its main contacts. Note the MPC TRIP light will remain illuminated for approximately 1 second during which time the network protector breaker must open its main contacts. After the 1-second interval the FLOAT light will again be illuminated. The network protector breaker should be tripped several times to ensure that the operation is consistent.

For testing the MPCR or MPCV, DO NOT remove any of the relay terminal screws or connect the COMM-RED-GREEN cable assembly. To do so will not permit the relay to receive its required input signals.

Phase Detection Test

All of the switch positions remain the same as used in the "Close Test". The MPCR or MPCV "PL" setting must be set to +5 degrees.

By rotating the VARIAC you can increase the overvoltage phasing value. The value chosen should be somewhat above that value which operated the network protector breaker in the MPC "Close Test". The MPC must not make it close contact. By changing the MPC "PL" setting back to the original -5 degree setting, the relay should once again make its close contact.

INDIVIDUAL RELAY TEST

**General Electric Electro-Mechanical
Type Can, CHN or CAL, CHL**

These test determine if the relays on a network protector breaker, type CAN or CHN, master relay, CAL or CHL phasing relay, are functioning properly and their setting in regard to overvoltage close, reverse current trip, time delay and instantaneous trip, is correct.

CAN OR CHN MASTER RELAY OVERVOLTAGE CLOSE TEST

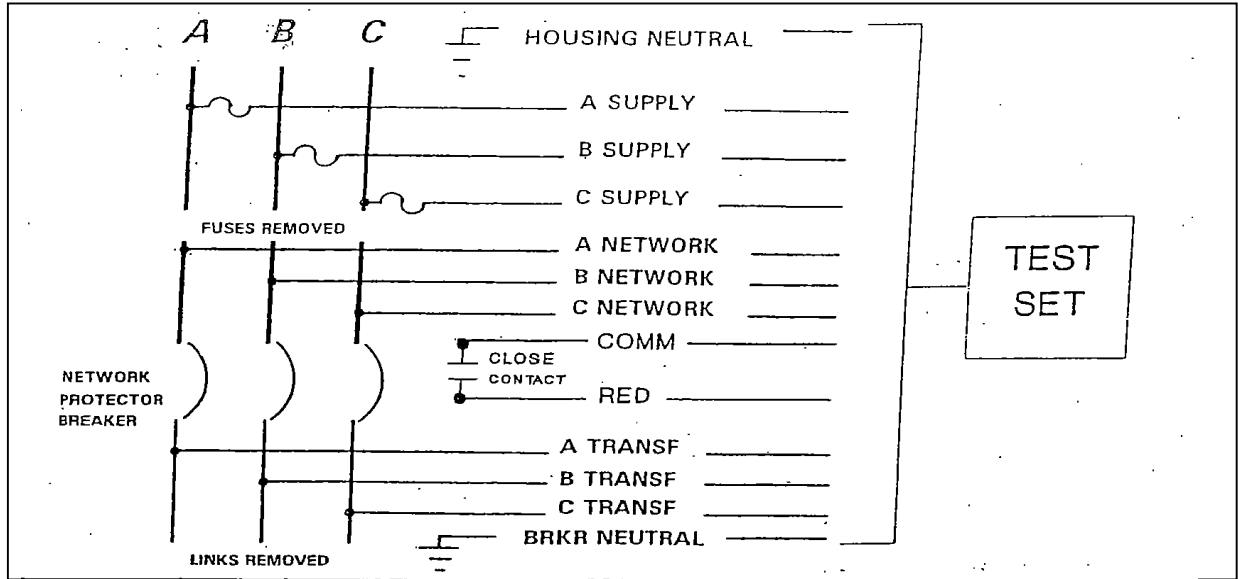

Before commencing work, refer to the Safety Information.

CAUTION

IF YOU REQUIRE RELAY CONTACT INDICATION THROUGH THE TEST SET'S RED AND GREEN INDICATING LAMPS YOU MUST ISOLATE THE TYPE CAN OR CHN "COMMON, TRIP AND CLOSE" LEADS. THESE LEADS ARE TYPICALLY IDENTIFIED ON A TYPE MG-8 IR MG-9 AS:

COMMON, AS WIRE #11; TRIP, AS WIRE #41 AND CLOSE, AS WIRE #6. REMOVE THESE THREE LEADS FROM THE RELAY TERMINAL STRIP.

THE HWT-500 LEAD MARKED "COMM" IS PLACED ON THE RELAY TERMINAL WHERE WIRE #11 WAS ATTACHED; LEADS MARKED "GREEN" IS PLACED ON THE RELAY TERMINAL WHERE WIRE #41 WAS ATTACHED; LEADS MARKED "RED" IS PLACED ON RELAY TERMINAL WHERE WIRE #6 WAS ATTACHED.

DO NOT USE THE LEADS MARKED "COMM-RED-GREEN" ON ENERGIZED CIRCUITS. ENERGIZING THESE LEADS MAY DAMAGE THE TEST SET.

Switch Positions

Network protector open and set for automatic operation.

FUNCTION Switch – "RELAY" position

I & PV Switch – PVA position

Supp VM Switch – CA position

PHASE switch – 0

Single PH Test Switch – OFF

VARIAC – zero position

PHASE volt switch – ON position

SUPPLY Switch – 216 or 480 position depending on network system voltage

By rotating the VARIAC you can increase the in phase (zero degrees) overvoltage phasing value to the desired overvoltage close value. The CAN or CHN relay overvoltage setting may be adjusted a limited amount by varying the tension of the control spring. This control spring is connected to a control spring adjusting shaft, which can be turned through the use of a screwdriver. The adjustment should be made until the red indicator light is illuminated.

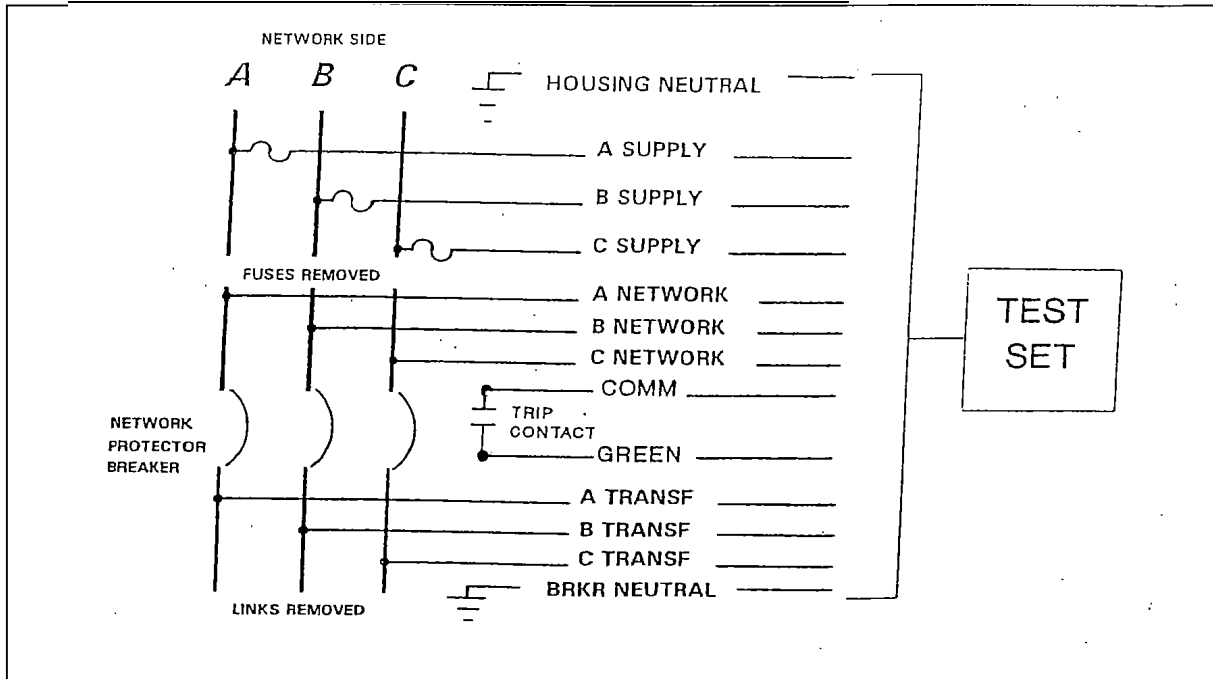
CAN OR CHN MASTER RELAY REVERSE CURRENT TRIP TEST

Before commencing work, refer to the Safety Information

Switch Positions

Network protector closed, breaker does not have to be in the automatic mode.

FUNCTION Switch – “RELAY” position

I & PV Switch – AI position

Supp VM Switch – CA position

PHASE switch – 180 position

Single PH Test Switch – OFF

VARIAC – zero position

SUPPLY Switch – 216 or 480 position depending on network system voltage

By rotating the VARIAC you can increase the reverse current value to the desired reverse current value. The green indicator lamp will illuminate when the CAN or CHN trip contact makes. The trip adjustment on the type CAN or CHN relay is accomplished by turning the mechanical restraint cap.

NOTE – On network protectors equipped with the delayed-sensitive trip, type PYC16 relay, the time delay relay is energized and the timing cycle starts when the CAN or CHN trip contact makes. Refer to the time delay relay type PYC16 trip test.

TYPE PYC16 DELAYED-SENSITIVE TRIP TEST

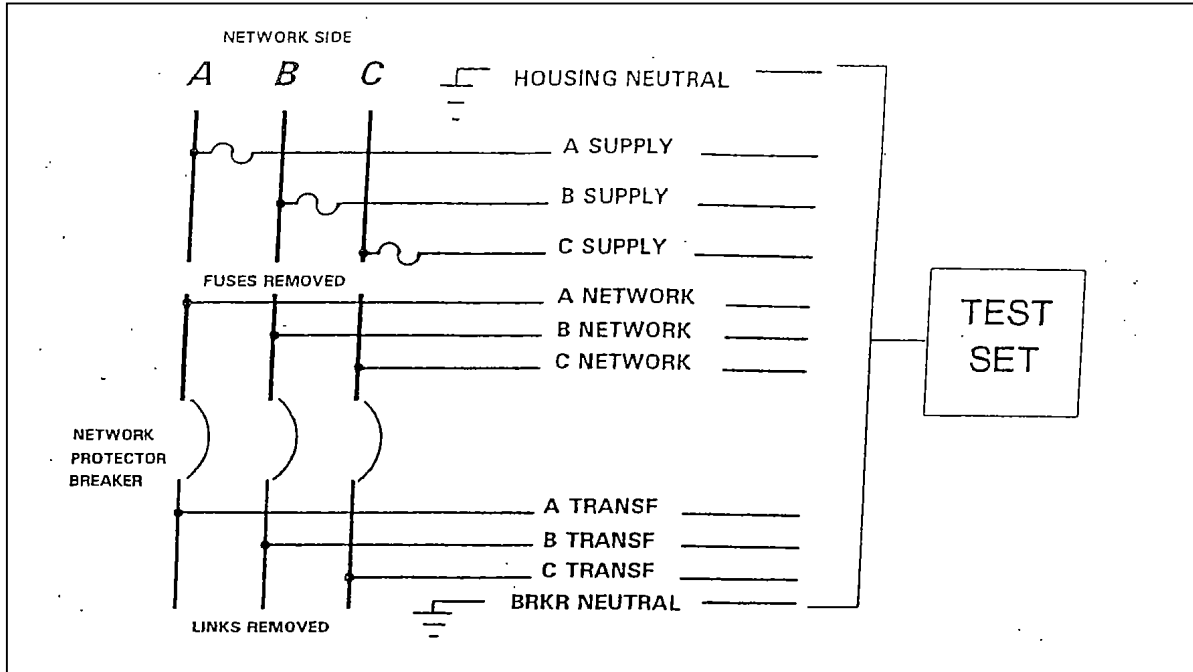

Before commencing work, refer to the Safety Information.

If you have wires #11, #41 and #6 disconnected from the relay terminal block, reinstall them before proceeding. On network protectors equipped with the type PYC16 delayed-sensitive relay, the time delay relay is energized and the timing cycle initiated when the CAN or CHN relay trip contact makes.

Switch Positions

Network protector closed, breaker does not have to be in the automatic mode.

FUNCTION Switch – “RELAY” position

I & PV Switch – AI position

Supp VM Switch – CA position

PHASE switch – 180 position

Single PH Test Switch – OFF

VARIAC – zero position

SUPPLY Switch – 216 or 480 position depending on network system voltage

Rotate the VARIAC and increase the reverse current trip value until the CAN or CHN relay trip contact makes. The timing cycle of the PYC16 starts from the instant the CAN or CHN relay trip contact makes until the network protector breaker trips. On those relays equipped with a thermal time delay element, allow the relay to cool to an ambient air temperature before commencing the test.

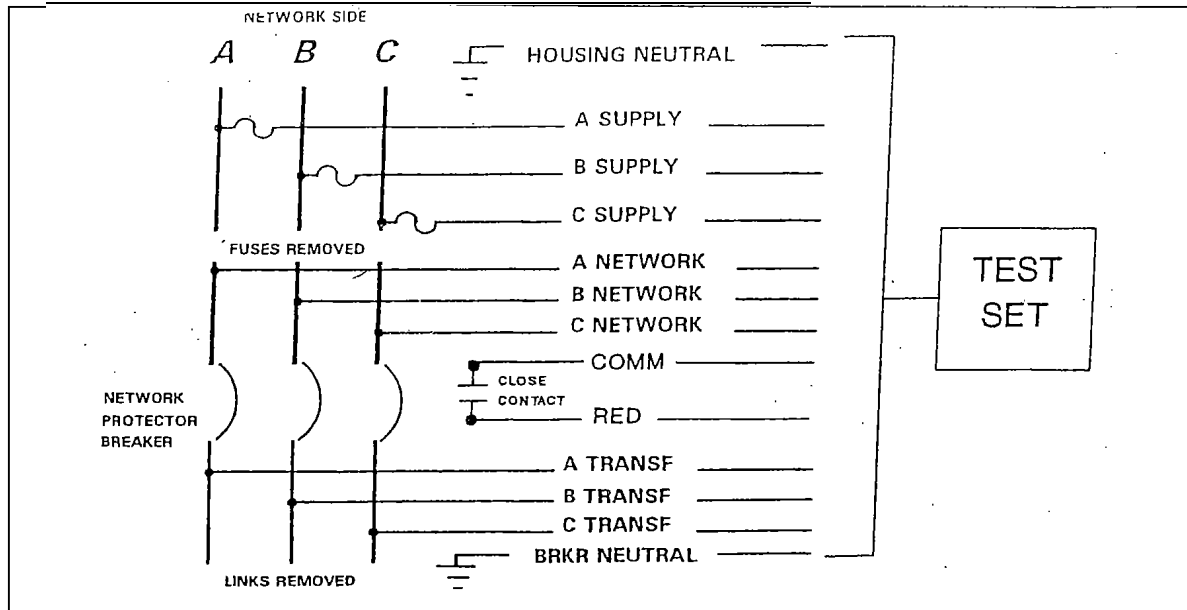
CAL OR CHL PHASING RELAY OVERVOLTAGE CLOSE TEST

Before commencing work, refer to the Safety Information.

CAUTION

IF YOU REQUIRE RELAY CONTACT INDICATION THROUGH THE TEST SET'S RED AND GREEN INDICATING LAMPS YOU MUST ISOLATE THE TYPE CAL OR CHL "COMMON AND CLOSE" LEADS. THESE LEADS ARE TYPICALLY IDENTIFIED ON A TYPE MG-8 OR MG-9 AS:

COMMON, AS WIRE #6 AND CLOSE, AS WIRE #6A. REMOVE THESE LEADS FROM THE RELAY TERMINAL STRIP.

THE HWT-500 LEAD MARKED "COMM" IS PLACED ON THE RELAY TERMINAL WHERE WIRE #6 WAS ATTACHED; LEAD MARKED "RED" IS PLACED ON THE RELAY TERMINAL WHERE WIRE #6A WAS ATTACHED.

DO NOT USE THE LEADS MARKED "COMM-RED-GREEN" ON ENERGIZED CIRCUITS. ENERGIZING THESE LEADS MAY DAMAGE THE TEST SET.

Switch Positions

Network protector open, breaker does not have to be in the automatic mode.

FUNCTION Switch – "RELAY" position

I & PV Switch – PVA position

Supp VM Switch – CA position

PHASE switch –60 position

Single PH Test Switch – OFF

VARIAC – zero position

PHASE volt switch – ON position

SUPPLY Switch – 216 or 480 position depending on network system voltage

By rotating the VARIAC you can increase the overvoltage phasing value to the desired overvoltage close value. The CAL or CHL setting may be changed from zero to 1.0 volts leading by varying the tension on the control spring. This adjustment is made through the control spring adjustment shaft. Adjustment should be made until the red indicator light is illuminated. It is important not to decrease the spring tension to the point where the contacts will not positively close when the relay is de-energized.

The standard factory close characteristic setting angle for the CAL or CHL is –5 degrees.

GENERAL ELECTRIC TYPE SSNPR SOLID STATE RELAY

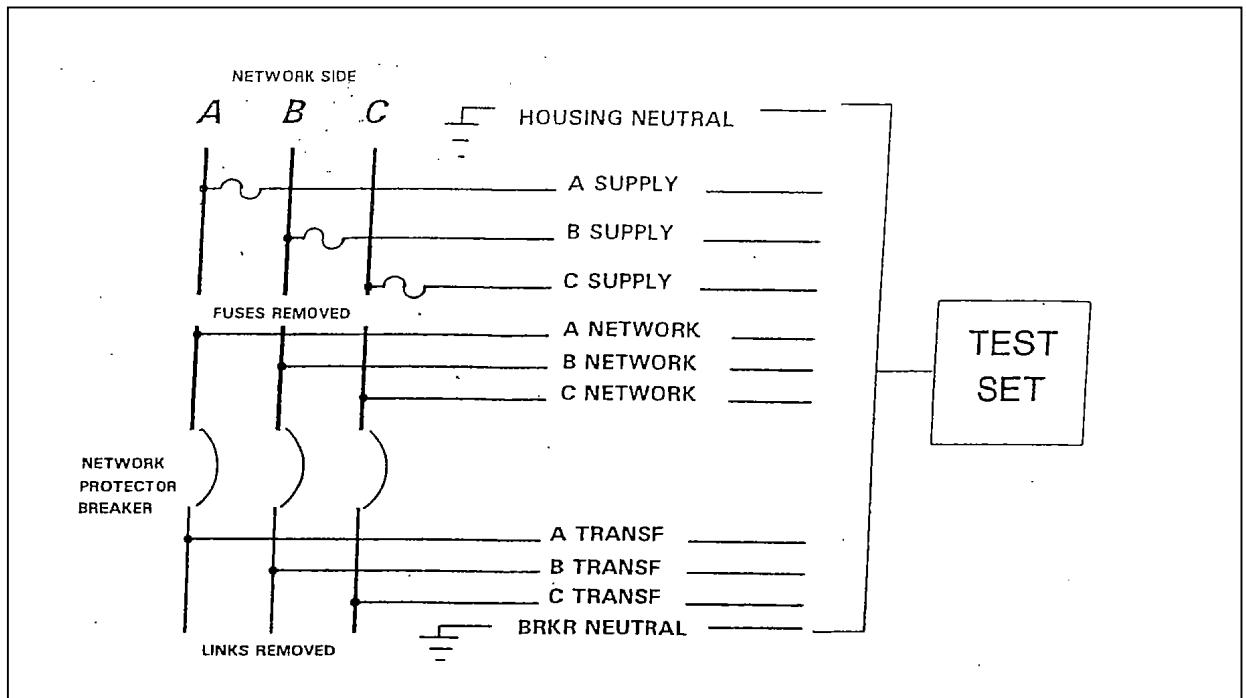

Before commencing work, refer to the Safety Information

CAUTION

THE SSNPR RELAY SWITCHES AN AC VOLTAGE THROUGH ITS TRIP AND CLOSE CONTACTS; FOR THIS REASON, DO NOT CONNECT THE "COMM-RED-GREEN" INDICATOR LEADS.

Switch Positions

Network protector open and set for automatic operation.

FUNCTION Switch – "RELAY" position

I & PV Switch – PVA position for close, AI for trip

Supp VM Switch – CA position

PHASE switch – 0 position for close, 180 for trip

Single PH Test Switch – OFF

VARIAC – zero position

SUPPLY Switch – 216 or 480 position depending on network system voltage

NOTE – Make certain that the phasing adjustment of the SSNPR is in the -5 degrees range before commencing the Close Test.

SSNPR Close Test

By rotating the VARIAC you can increase the overvoltage phasing value to the desired value at which the SSNPR close contact makes and the breaker contacts close. The value at which the protector closes is the reclose setting of the SSNPR. If it is necessary to increase or decrease this value by less than (+/-) 20% for models 10 and 20SSNPR or (+/-) 40% for model 30 and 40 SSNPR, then the following steps are necessary:

- A. Set the reclose voltage adjust on the SSNPR to maximum (clockwise).
- B. Apply the desired overvoltage phasing value across the open network protector.
- C. While depressing the phase detector bypass switch, on the relay, slowly turn the reclose voltage adjust counterclockwise until the protector closes.
- D. The SSNPR should now be calibrated for the new overvoltage close setting. Reapply the new overvoltage close value and verify that the breaker does close its contacts at the predetermined setting.

SSNPR Trip Test

All of the switch positions remain the same as used in the "Close Test" with the exception of the Phase switch which must be changed to the 180 position. The network protector breaker must be closed and the I & PV switch must be changed to AI position.

By rotating the VARIAC you can increase the reverse current value to the desired value at which the network protector contacts open. This value becomes the trip current setting of the SSNPR. If this value is not correct and you wish to change the reverse trip setting, the following steps are necessary:

- A. Set the trip current adjust on the SSNPR to maximum (clockwise).
- B. Apply the desired reverse current through the closed network protector.
- C. Slowly turn the trip adjust counterclockwise until the network protector trips.
- D. The SSNPR should now be calibrated for the new current setting. Reapply the reverse current and reaffirm the new trip setting.

Phase Detection Test

All of the switch positions remain the same as used in the "Close Test". The SSNPR phase angle adjust setting must be set to the +5 degrees (maximum clockwise) position.

Apply a zero degree (in phase) overvoltage close value that is much higher than the previously calibrated value. Note that the network protector does not close. Depress the phase detector bypass switch, on the relay, and note that the network protector does close. This test verifies the correct functioning of the phase detector.

Restore the phase angle adjust to the original setting.

Time Delay Module Test (Optional)

Although the instantaneous overcurrent pickup point cannot be calibrated, the time delay function of the module can be tested. Install the time delay module on the SSNPR. Make certain that the network protector contacts are closed.

All the switch positions remain the same as used in the "Close Test" with the exception of the Phase Switch that must be changed to the 180 position.

By rotating the VARIAC you can increase the reverse current value. This value should be quickly increased to approximately twice the nominal trip setting. At this point begin the timing sequence and end the timing sequence when the network protector breaker trips. The standard time setting is variable from 20 to 200 seconds and is adjusted using the time potentiometer located on the time delay module.

SSNPR Watt-Var Module Trip Test (Optional)

The test connections are the same as shown on page 33.

Switch Positions

Network protector closed and set for automatic operation.

TEST Switch – "RELAY" position

I & PV Switch – AI position

Supp VM Switch – CA position

PHASE switch – 180 position

VARIAC – zero position (not used in this test)

SUPPLY Switch – 216 or 480 position depending on network system voltage

NOTE – Make certain that the phasing adjustment of the SSNPR is in the –5 degrees range before commencing the Close Test.

A pushbutton test switch is provided on this module to permit testing of the watt-var shift without the need of an overcurrent condition. When this test switch is depressed the magnitude of reverse current required to trip the protector will increase approximately four times its nominal 180-degree value.

By rotating the VARIAC you can increase the reverse current value. The point at which the network protector breaker trips should be approximately four times the nominal trip value at 180 degrees. This increase in trip current proves that the watt-var function is performing properly.

GENERAL ELECTRIC MECHANISM COMPONENT TESTS

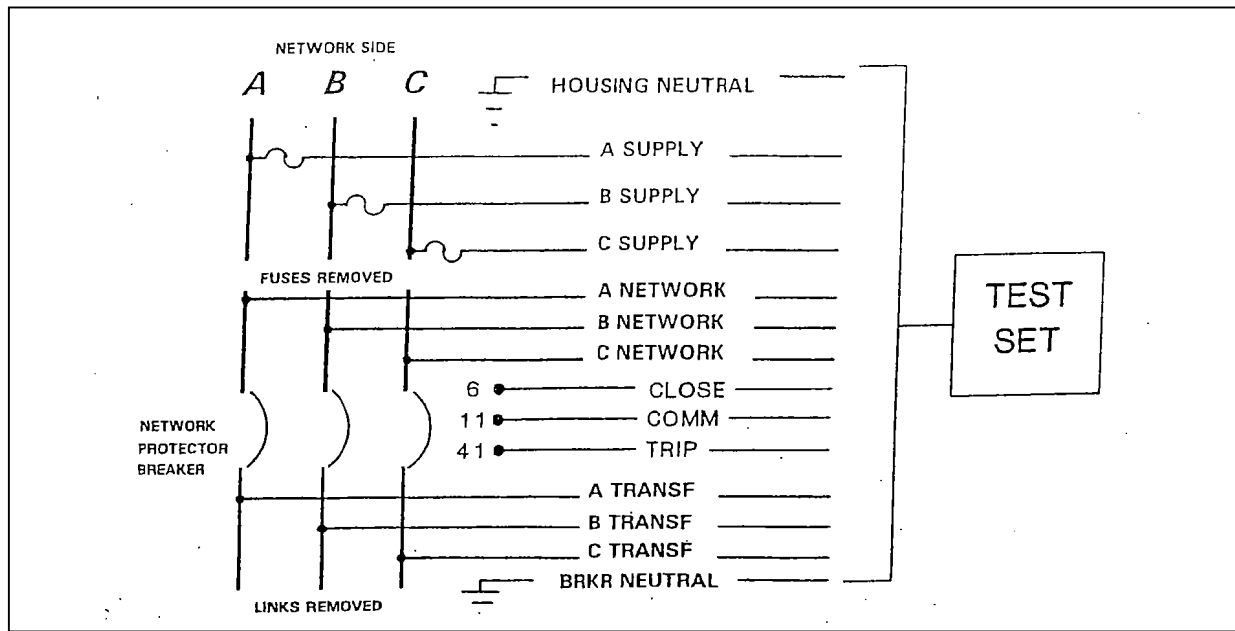

Before commencing work, refer to the Safety Information.

Switch Positions

Network protector open and set for automatic operation with the relays removed.

FUNCTION Switch – “MECH” position	I & PV Switch – AI
Supp VM Switch – CA position	PHASE switch – 0 position
Single PH Test Switch – OFF	VARIAC – zero position
PHASE Volt Switch – OFF position	

SUPPLY Switch – 216 or 480 position depending on network system voltage

In this test, voltage is controlled by the variable autotransformer. Before commencing the test, remove any PYC relay and replace the shunting links (jumpers) to complete the current transformer circuits. You must know the general breaker wiring configuration for the motor close and trip circuits. For example, you must know whether the motor is connected phase-to-phase or phase-to-ground as well as the trip device. This information can best be obtained from the wiring diagram of the network protector breaker under test.

For mechanical closing operations the Supply VM switch should be in the CA position and should read zero. This is based on breakers which have the closing motor wired A-B phase to phase and the reading on the VOLTMETER reflects voltage applied between cable terminal TA and TB. Closing values for both line-to-line and line-to-neutral wired breakers are indicated on the charts located on page 37.

Turning the VARIAC clockwise will decrease the potential as shown on the VOLTMETER. Set the potential for minimum voltage close of either the motor or the motor control relay. Once the value is determined and established on the VOLTMETER, push the CLOSE push button and the breaker component or the breaker should operate. Once the breaker has closed, the VARIAC should be set to zero.

By turning the VARIAC control knob clockwise will increase the voltage displayed on the VOLTMETER. Set the voltage to the minimum trip level and push the Trip pushbutton. The breaker must open its contacts at the minimum voltage level.

The network protector breaker failing to close or trip during these minimum voltage series of tests can indicate a mechanism or trip device that needs immediate attention. Records should be made of the minimum voltage values so that a year-to-year comparison can be made. Slow deterioration of the motor or trip device can be observed over the years by making such comparisons. Pin pointing such problems in advance can lead to lower maintenance costs over the life of the equipment.

Rated Voltage of Network Protector	L-L	Control Relay 90-106%	Closing Motor 73-106%	Tripping Voltage 7 ½ - 106 Percent
125/216	L-L	170-230	157-230	16-230
277-480	L-G	220-295	200-295	36-510 *
277/480 or 480	L-L	385-510	350-510	36-510
* Trip coil connected line-to-line				

HWT-500 MAINTENANCE AND REPAIR

The HWT-500 test set utilizes durable switches and components to insure years of maintenance free service. If maintenance is required, the unit should be serviced in a clean environment away from and disconnected from energized circuits. The following routine maintenance is recommended:

- A. Remove the test set cover and examine the unit for signs of collected dirt or moisture.
- B. Remove the dust covers on the P1 and P2 cable input sockets and examine the contacts for excessive dust, moisture or corrosion.
- C. Any collected dust should be removed with dry compressed air.
- D. Any collected moisture should be absorbed, as much as possible, into a clean cloth or towel. The unit can then be placed into a slightly elevated temperature environment (40 C) to force dry the remaining moisture.
- E. Inspect the two cable assemblies for loose connections to the alligator clips or for frayed wires.

The major active components of the HWT-500 test set are mounted to the front panel assembly or are located within the body of the test set case.

To gain access into the case:

1. Remove the qty. (4) ¼-20 bolts located at the left and right hand side of the front panel.
2. Remove the qty. (4) ¼-28 bolts used to secure the VARIAC to the front panel assembly. These are located outside the VARIAC circular dial plate.
3. Remove the VARIAC knob using a 3/32 Allen wrench. Note there are two set screws securing the knob to the VARIAC shaft.
4. Using the black face mounted handles, carefully lift the panel assembly over the VARIAC shaft and tilt the panel assembly on the left-hand side of the test set.
5. At this point, the front panel assembly can be separated from the case by removing P1 and P2, 28 pin plugs. These plugs are fixed to their respective sockets with two hold-down screws.

NOTE – DO NOT tighten these hold-down screws beyond hand tight.

To re-assemble, reverse the above sequence. Make certain that the P1 and P2 plug are inserted into the correct plug position. Again, do not over-tighten the plug hold-down screws beyond hand tight. Make certain that none of the harness gets pinched between the front cover plate and the body of the test set.

A list of available renewal parts is tabulated in Table 2 on page 41.

TABLE 1 – SUGGESTED RELAY SETTINGS

When using the HWT-500 test set to calibrate relays mounted on the network protector breaker, the settings listed below will satisfy the majority of dedicated feeder, distributed grid or spot network applications. In some cases, however, it may be necessary or advisable to modify these adjustments to meet particular system conditions (such as where the network units are supplied from non-dedicated primary feeders or where there exists an unusual relationship between the primary feeders).

216Y/125 Volt Network Protectors**Master Relay**

Reverse Current at 180 degrees (protector breaker closed):
 Trip contact makes at 0.2% of protector current transformer rating.

Overvoltage close at 0 degrees (protector breaker open):
 Close contact makes at 1.5 volts.

Phasing Relay

Overvoltage close at 60 degrees (protector breaker open):
 Contact open at 0.0 volts <-IMPORTANT
 Contact closed at 0.5 volts.

480Y/277 Volt Network Protectors**Master Relay**

Reverse current at 180 degrees (protector breaker closed):
 Trip contact makes at 0.2% of protector current transformer rating.

Overvoltage close at 0 degrees (protector breaker open):
 Close contact makes at 3.3 volts.

Phasing Relay

Overvoltage close at 60 degrees (protector breaker open):
 Contact open at 0.0 volts <- IMPORTANT
 Contact closed at 0.5 volts.

NOTE

WHEN 216-VOLT RELAYS WITH POTENTIAL AUTOTRANSFORMERS ARE USED ON 480-VOLT PROTECTORS, THE 216-VOLT RELAYS ACTUALLY "SEE" THE ABOVE VOLTAGE DIVIDED BY 2.2.

SUGGESTED TRIP SETTINGS

These values are based on a setting of 0.2% of the protector current transformer rating. The chart below lists the standard ratio of C.T. which would be supplied for any given network protector rating. Be alerted, however, that network protector current transformers, and their ratios, may have been changed at the time of manufacture, upon request, or may have been changed after installation.

Ampere Protector Ratings	CT Ratio	Ampere Suggested Trip Setting at 180
800	800/5	1.6
1200	1200/5	2.4
1600	1600/5	3.2
1875	1600/5	3.2
2000	2000/5	4.0
2250	2000/5	4.0
2500	2500/5	5.0
2825	2500/5	5.0
3000	3000/5	6.0
3500 *	3000/5	6.0
4500	3000/5	6.0

* G.E. 3500A Network Protectors are normally supplied with 3500/5 ratio C.T.'s.

TABLE 2

SUGGESTED RENEWAL PARTS

Item description	Style #
Supply Switch	NWD0101 Fig 2
Phasing Switch	NWD0101 Fig 3
Supply Volt Switch	NWD0101 Fig 1
IV Switch	NAS0111H05
Test Switch	NAS0111H08
Single PH Switch	NWD0102G01
CT/PT	NDT0286H01
Ammeter	NDT0256H01
Voltmeter	NDT0258H01
Ammeter CT PCB	NAS0082G01
Sequence Lamp PCB	NAS0081G01
150 Ohm Res. Assembly	NAS0114G01
R1 Relay	D15CR13BB
LTX Txfr	C0050E3A
CPT	467-300
3 PH Variac	226U-3
48V lamp Assembly	10250T208N
Red lens	10250C1N
Green Lens	10250C2N
Yellow Ind Lamp	10250T34Y
Green P/B	1025023G
Red P/B	10250T23R
30' P1 Cable Ass'y	NAS0119G01
30' P2 Cable Ass'y	NAS0119G02
P1 Protective Cap	211904-1
P2 Protective Cap	211903-1

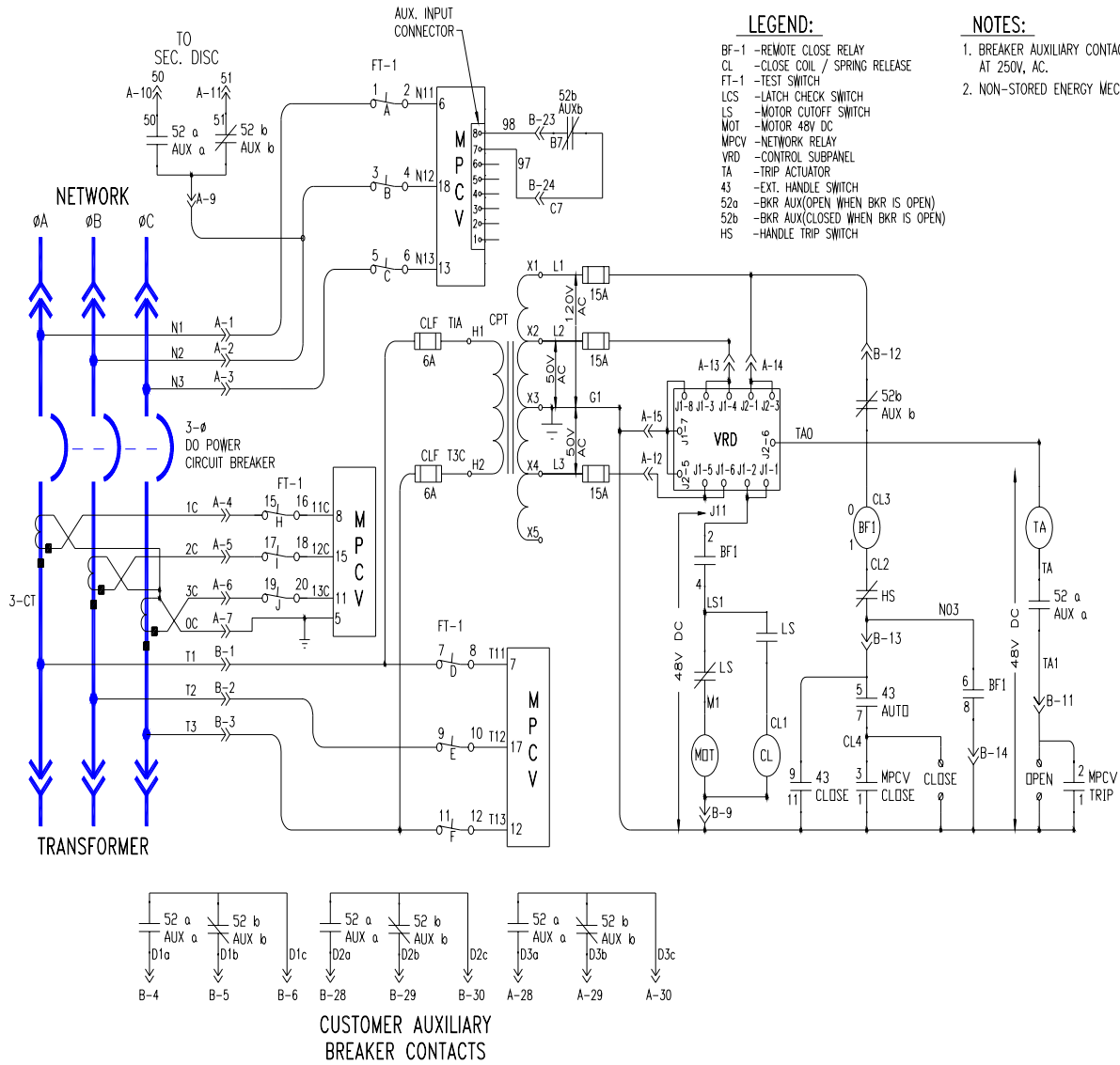

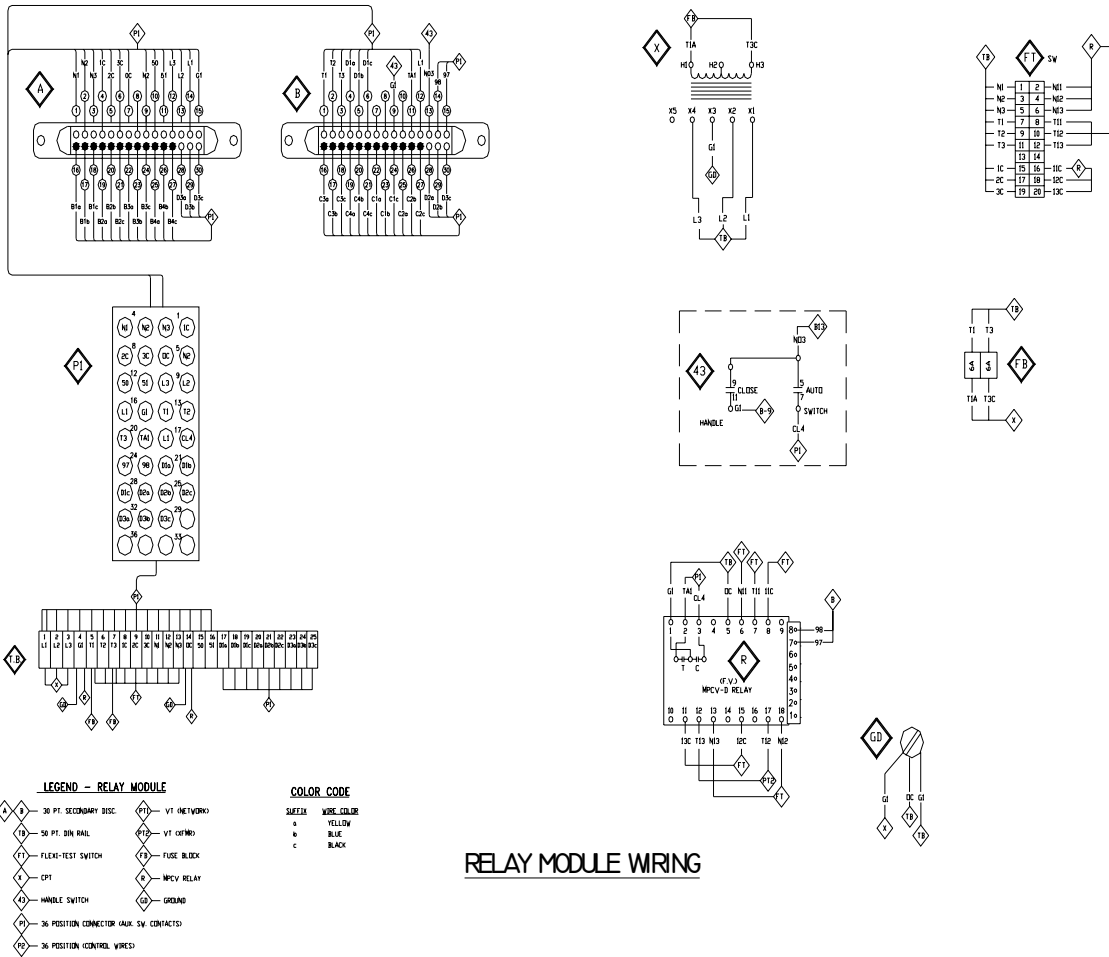

RELAY MODULE WIRING

216V Relay Module Wiring

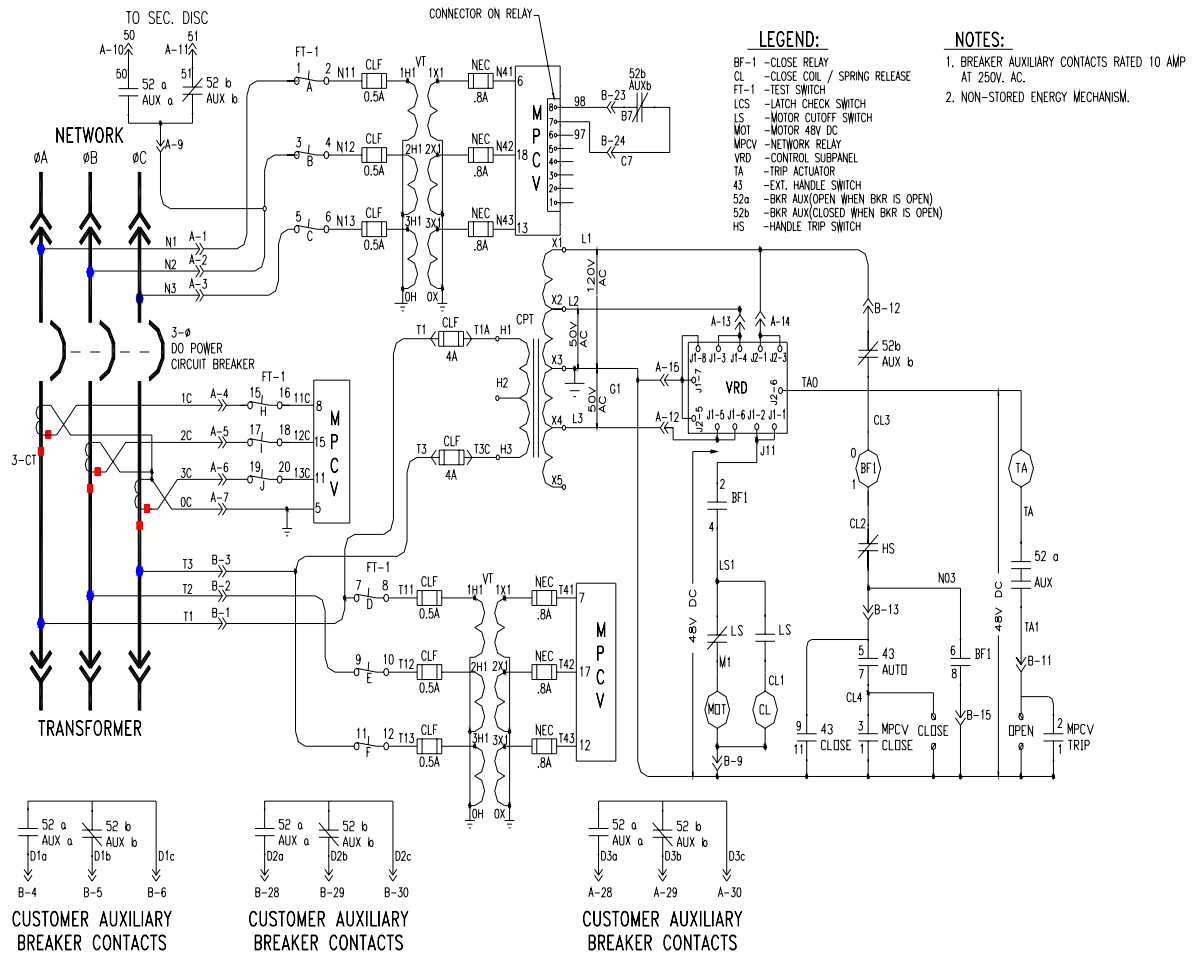

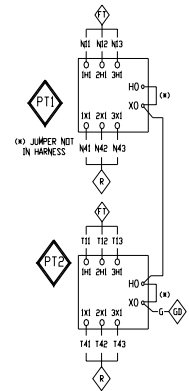
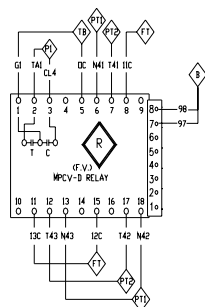
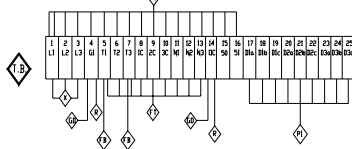
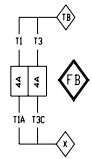
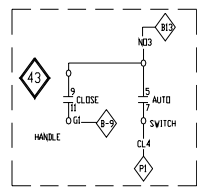
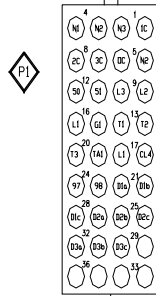
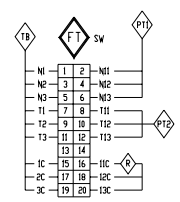
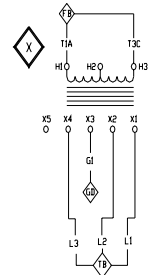
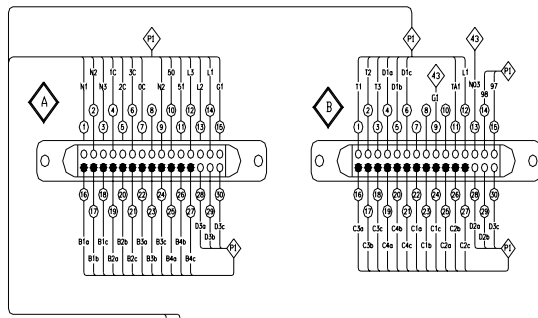

- LEGEND - RELAY MODULE**
- A - 30 PT. SECONDARY DISC
 - B - 50 PT. DIN RAIL
 - F1 - FLEXI-TEST SWITCH
 - X - EPT
 - 43 - HANDLE SWITCH
 - P1 - 36 POSITION CONNECTOR (AUX. SW. CONTACTS)
 - PC - 36 POSITION (CONTROL WIRES)
 - PT1 - VT ONE/WORK
 - PT2 - VT OFF/WO
 - FB - FUSE BLOCK
 - R - MPCV RELAY
 - G - GROUND

- COLOR CODE**
- | WIRE # | WIRE COLOR |
|--------|------------|
| a | YELLOW |
| b | BLUE |
| c | BLACK |

RELAY MODULE WIRING

480Volt Relay Module Wiring