

Driver Instructions

Video Instruction Available

Instructional videos are available for download at no charge at roadranger.com

Videos are also available for purchase. To order, call 1-888-386-4636. Ask for item # RRSD0002

Fuller Heavy Duty Transmissions TRDR0630 December 2010



Powering Business Worldwide

BACKED BY

Roadranger

SUPPORT

General Information

Warnings and Cautions



Read the entire driver instructions before operating this transmission.

Set the parking brakes before starting a vehicle, always be seated in the driver's seat, move the shift lever to neutral, and depress the master clutch.

If the engine cranks in any gear other than neutral or without the master clutch depressed, service your vehicle neutral safety start circuit immediately.

Before working on a vehicle or when leaving the cab with the engine running, place the transmission in neutral, set the parking brakes, and block the wheels.

Do not release the parking brake or attempt to select a gear until the air pressure is at the correct level.

When parking the vehicle or leaving the cab, always place the shift lever in neutral and set the parking brakes.

If your vehicle is equipped with a remote throttle, before operation, the transmission must be in neutral.

TOWING: To avoid damage to the transmission during towing, disconnect the driveline.

Table of Contents

General Information

How to Use This Manual	1
Identification Tag	2
Model Designation	3
General Information	4

Operation

Shift Pattern Diagram	4
Shift Lever Positions	5
Shift Controls	7
Transmission Features	8
Range Shift	8
Preselect	8
Splitter Shift	8
Optional Equipment	9
Driving Tips	10
Double-Clutching Procedure	11
Initial Start Up	12
Upshifting	13

Service & Maintenance

Lubrication	16
Maintain Proper Oil Level	16
Oil Filter	17
Transmission Operating Angles	18
Operating Temperatures with Oil Coolers	18
Oil Cooler Char	19
Preventive Maintenance	20

Reference

Definitions/Glossary of Terms for Transmission	
Operation	22

General Information

Purpose

This manual is designed to provide detailed information necessary for the proper driving techniques of the Fuller[®] transmissions listed on the cover.

How to Use This Manual

Driver instructions are divided into two sections: Transmission Operation and Service and Maintenance. Transmission Operation contains information on driving techniques along with shift patterns. Service and Maintenance contains informatio that deals with basic service and maintenance; such as, identification tags and lubrication information.

The two sections are laid out with a general heading at the top outside edge of each page followed by more specific headings labeling the information. To find the information you need, refer to the Table of Contents or page through the book section that covers what you need.

Identification Tag

Transmission Tag and Location

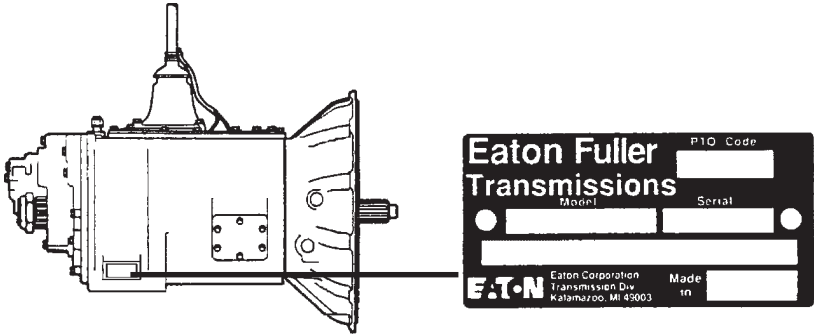

DO NOT REMOVE OR DESTROY THE TRANSMISSION IDENTIFICATION TAG.

Transmission model designation and other transmission identification information are stamped on the transmission tag. To identify the transmission model designation and serial number, locate the tag on the transmission and then locate the numbers as shown (example: RTLO-14610B).

Record transmission identification data. Have these reference numbers handy when ordering replacement parts or requesting service information.

General Information

Model Designation

Nomenclature

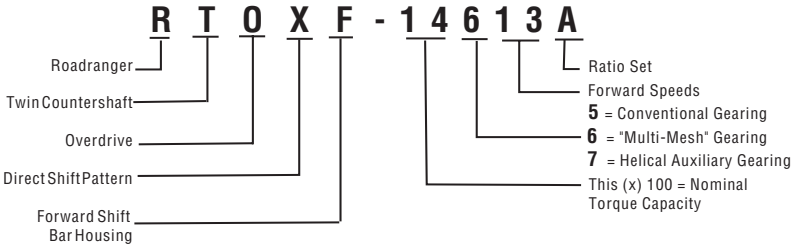

General Information

Models in this series provide thirteen forward speeds and two reverse, consisting of a 5-speed front section and a 3-speed auxiliary section. The auxiliary section contains LO and HI range ratios, plus an overdrive splitter gear.

The 1st position in the front section is used only as a starting gear. The other four ratios are used once in LO range and once again in HI range. Each of the four ratios, when used in HI range, can be split with the overdrive splitter gear.

After shifting out of the 1st position, you use the easy Roadranger repeat "H" shift pattern. LO range and HI range are selected with the Range Knob/Range Lever. It is used once during the upshift sequence and once during the downshift sequence.

Always preselect the range shift. After preselection, the transmission will automatically make the synchronizer range shift as the shift lever passes through neutral.

When in HI range the ratios can be split by using the Splitter Control Button. The Direct/Rearward position gives the 5th, 6th, 7th, and 8th speed ratios: the Overdrive/Forward position splits each of the HI range speed ratios. Therefore, eight progressive HI range ratios can be obtained.

Shift Pattern Diagram

A shift pattern diagram should be in your vehicle. If it has been lost, a replacement may be obtained by writing to:

Eaton Corporation
Truck Components
Global Marketing Services
P.O. Box 4013
Kalamazoo, MI 49003
www.roadranger.com

Please specify shifting controls used and transmission model number when making request.

Operation

Shift Lever Positions

RT & RTF

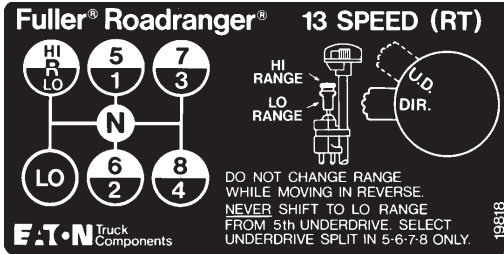

RTO, RTOF, RTX0 & RTX0F

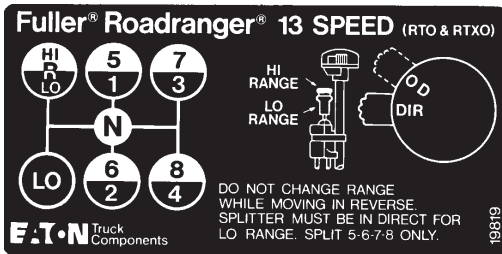

RT00 & RT00F

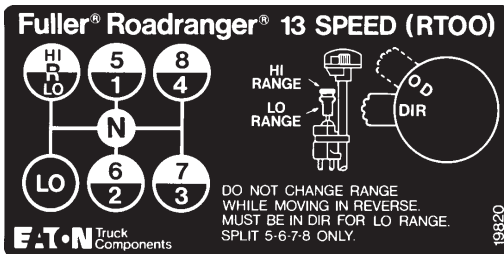

Operation

RT & RTF

Eaton Fuller Roadranger Transmissions

HI P LO	5 1	7 3
Neutral		
LO	6 2	8 4

13 SPEED (RT)
RANGE SELECTOR

SPLITTER SELECTOR
MAY BE SHIFTED IN 5-8-7-3 ONLY
DO NOT RANGE SHIFT WITH SPLITTER SELECTOR IN OD

PRE-SELECT ALL RANGE SHIFTS
MOVE RANGE SELECTOR BEFORE MOVING SHIFT LEVER

UPSHIFTING
START WITH RANGE SELECTOR DOWN
SHIFT 1-2-3-4 RAISE RANGE SELECTOR
SHIFT 5-6-7-8

DOWNSHIFTING
SHIFT 7-6-5-4 MOVE RANGE SELECTOR DOWN
SHIFT 4-3-2-1-LO

DO NOT CHANGE RANGE WHILE MOVING IN REVERSE

EATON

WARNING PUT TRANSMISSION IN NEUTRAL BEFORE STARTING ENGINE

20160

RTO, RTOF, RTOX & RTOXF

Eaton Fuller Roadranger Transmissions

HI P LO	5 1	7 3
Neutral		
LO	6 2	8 4

13 SPEED (RTO & RTOX)
RANGE SELECTOR

SPLITTER SELECTOR
MAY BE SHIFTED IN 5-8-7-3 ONLY
DO NOT RANGE SHIFT WITH SPLITTER SELECTOR IN OD

PRE-SELECT ALL RANGE SHIFTS
MOVE RANGE SELECTOR BEFORE MOVING SHIFT LEVER

UPSHIFTING
START WITH RANGE SELECTOR DOWN
SHIFT 1-2-3-4 RAISE RANGE SELECTOR
SHIFT 5-6-7-8

DOWNSHIFTING
SHIFT 7-6-5-4 MOVE RANGE SELECTOR DOWN
SHIFT 4-3-2-1-LO

DO NOT CHANGE RANGE WHILE MOVING IN REVERSE

EATON

WARNING PUT TRANSMISSION IN NEUTRAL BEFORE STARTING ENGINE

20161

RT00 & RT00F

Eaton Fuller Roadranger Transmissions

HI P LO	5 1	8 4
Neutral		
LO	6 2	7 3

13 SPEED (RT00)
RANGE SELECTOR

DEEP REDUCTION

DO NOT RANGE SHIFT WITH SPLITTER SELECTOR IN OD

PRE-SELECT ALL RANGE SHIFTS
(MOVE RANGE SELECTOR BEFORE MOVING SHIFT LEVER)

UPSHIFTING
START WITH RANGE SELECTOR DOWN
SHIFT 1-2-3-4 RAISE RANGE SELECTOR
SHIFT 5-6-7-8

DOWNSHIFTING
SHIFT 7-6-5-4 MOVE RANGE SELECTOR DOWN
SHIFT 4-3-2-1-LO

DO NOT CHANGE RANGE WHILE MOVING IN REVERSE

EATON

WARNING PUT TRANSMISSION IN NEUTRAL BEFORE STARTING ENGINE

20162

Operation

Shift Controls

Range Valve (A-3546) with Two-Position Selector Valve (A-4491/4494)

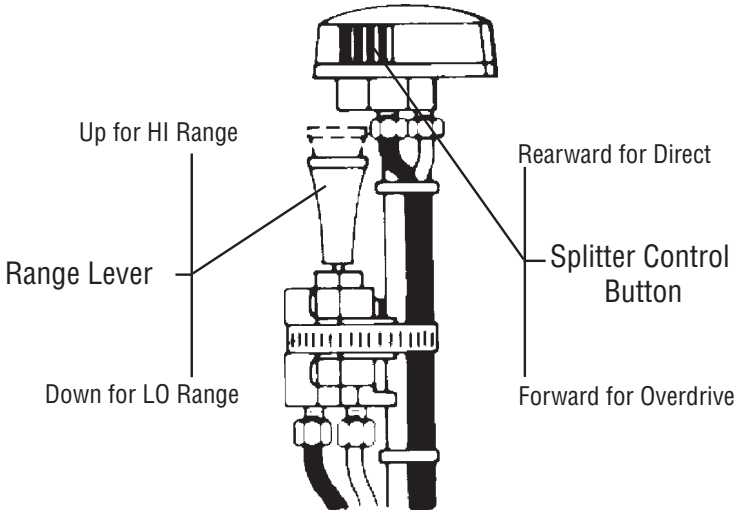

Roadranger Valve - A-4900

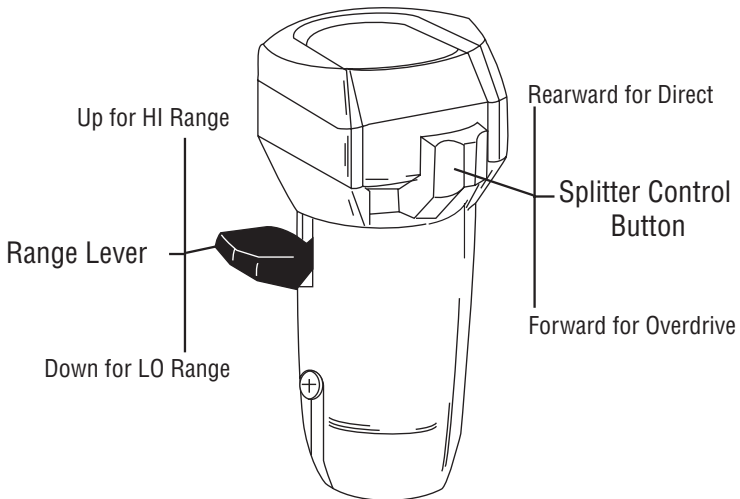

Transmission Features

Range Shift

The range lever selects LO or HI range. It is used once during an upshift sequence and once during a downshift.

Preselect



Always preselect all range shifts when upshifting or downshifting. Preselection requires that the range lever is moved to the needed position before starting the shift.

Preselected range shifts are completed automatically as the lever is moved through neutral and into the next gear. Preselecting all range shifts prevents damage to the transmission and provides for smoother shifts.

Splitter Shift

The splitter control button selects HI range direct or HI range overdrive. It is used in each HI range speed ratio.

Operation

Optional Equipment

For easier and faster gear engagement while the vehicle is standing still, some Fuller® transmissions may be equipped with either a Countershaft Brake or a Clutch Brake.

Countershaft Brake

(Used with push-type clutches) - The control button is mounted on the shift lever just below the shift knob. To operate, disengage the clutch, press down the control button, and shift into LO or reverse. This is an air operated mechanical brake which slows down the transmission gearing by forcing a piston against the countershaft PTO gear. Never use the Countershaft Brake when upshifting or downshifting. Use **only** for initial gear engagement when the vehicle is standing still.

Clutch Brake

(Used with pull-type clutches) - The clutch brake is applied by fully depressing the clutch pedal to the floor board. When applied the brake slows down and can stop the transmission front box gearing. It is a disc-type brake incorporated into the clutch and transmission drive gear assemblies. Never use the Clutch Brake when upshifting or downshifting. Use **only** for initial gear engagement when the vehicle is standing still.

Driving Tips

- Always select an initial starting gear that provides sufficient reduction for the load and terrain.
- Always use normal double-clutching procedures when making lever shifts.
- Never slam or jerk the shift lever to complete gear engagements.
- Never coast with the shift lever in the neutral position.
- Never move the range lever with the shift lever in neutral while the vehicle is moving.
- Never make a range shift while moving in reverse.
- Never downshift at too high of a road speed.
- In most cases, depending on the engine and axle ratios, you can save valuable fuel by operating the vehicle at less than governed RPM while cruising in top gear.
- Never move the shift lever to the LO speed gear position while operating in HI range.
- Never make a splitter shift while moving in reverse.
- Do not lug engine below peak torque (1200 RPM.)

Operation

Double-Clutching Procedure

When ready to make a shift:

1. Depress the pedal to disengage the clutch.
2. Move the gear shift lever to neutral.
3. Release the pedal to engage the clutch. (See Note)
 - UPSHIFTS - Decelerate engine until engine RPM and road speed match.
 - DOWNSHIFTS - Accelerate engine until engine RPM and road speed match.
4. Quickly depress pedal to disengage clutch and move gear shift lever to next gear speed position.
5. Release pedal to engage clutch.

Note: By engaging the clutch with the gear shift lever in the neutral position, the operator is able to control the RPM of the mainshaft gears since they are regulated by engine RPM. This procedure enables the operator to match the RPM of the mainshaft gears with those of the mainshaft driven by the vehicle's rear wheels.

Initial Start Up

Special Instructions

 **WARNING**

Before starting a vehicle always be seated in the driver's seat, move the shift lever to neutral, and set the parking brakes.

 **CAUTION**

Before moving a vehicle, make sure you understand your shift pattern configuration. A shift label should be in your vehicle's cab. If not, refer to General Information to order one.

Procedure -

1. Make sure the shift lever is in neutral and the parking brakes are set.
2. Turn on the key switch, start the engine.
3. Allow the vehicle air pressure to build to the correct level. Refer to your "Operator and Service Manual" supplied with the truck.
4. Apply the service brakes.
5. Make sure the range lever is down in the LO range position and the splitter control button is rearward.



Range Lever **MUST** be down in the LO Range position for LO Range.



And Splitter Control Button Rearward in Direct

6. Depress the clutch pedal to the floor.
7. Move the shift lever into desired initial gear.
8. Release the parking brakes on the vehicle.
9. Slowly release the clutch pedal and apply accelerator.

Operation

Upshifting

In the following instructions, it is assumed that the driver is familiar with operating heavy-duty trucks and tractors, and can coordinate the movement of the shift lever and clutch pedal to make smooth gear engagements while upshifting or downshifting. Always double-clutch when making lever shifts.

 CAUTION

Never move the range lever or the splitter control button with the shift lever in neutral while the vehicle is moving.

1. Move the shift lever, double-clutching, to the next gear position in LO range.

Range Shift - LO to HI Range Direct (4th to 5th DIR)

2. When in last gear position for LO range and ready for the next upshift, pull up the Range Lever and move the shift lever, double-clutching, to the next higher speed position according to your shift pattern. As the shift lever passes through neutral, the transmission will automatically shift from LO to HI range.

 CAUTION

Never move the shift lever to the LO speed gear position after HI range preselection, or at anytime the transmission is in HI range.

Splitter Shift - HI Range Direct to HI Range Overdrive (5th DIR to 5th OD)

3. Move the splitter control button into the forward/overdrive position.
4. Then, **immediately**, release the accelerator, depress the clutch pedal once to break torque, release the pedal to reengage clutch, and accelerate the engine. The transmission shifts from direct to overdrive when synchronous is reached.

Operation

Combination Range Shift and Splitter Shift - HI Range Overdrive to HI Range Direct (5th OD to 6th DIR)

5. Immediately depress the clutch and move the gear shift lever to neutral. Release the clutch, depress again, move the gear shift lever into sixth gear, and move the splitter control button rearward into the direct position. Release the clutch pedal and accelerate.

 CAUTION

Never move the splitter control button or the range lever with the shift lever in neutral while the vehicle is moving.

6. Continue upshifting through the shift pattern. Double-clutching during lever shifts, single-clutch during split shifts while the shift lever is in the same position.

Downshift Procedure

In the following instructions, it is assumed that the driver is familiar with operating heavy-duty trucks and tractors, and can coordinate the movement of the shift lever and clutch pedal to make smooth gear engagements while upshifting or downshifting. Always double-clutch when making lever shifts.

 CAUTION

Never move the range lever or the splitter control button with the shift lever in neutral while the vehicle is moving.

Splitter Shift - HI Range Overdrive to HI Range Direct (8th OD to 8th DIR)

1. Move the splitter control button into the rearward/direct position.
2. Then, **immediately**, release the accelerator, depress the clutch pedal once to break torque, release the pedal to reengage clutch, and accelerate the engine. The transmission shifts from overdrive to direct when synchronous is reached.

Operation

Combination Range Shift and Splitter Shift - HI Range Direct to HI Range Overdrive (7th DIR to 6th OD)

3. Move the splitter control button into the forward/overdrive position.
4. Then, **immediately** move the shift lever, double-clutching, to the next lower gear position. If the splitter control button is not moved, the transmission will be in 7th direct once the final clutch engagement is made.
5. Continue downshifting through HI range. Double-clutching during lever shifts, single-clutch during split shifts while the shift lever is in the same position.

Range Shift from HI Range Direct to LO Range (5th DIR to 4th)

6. While in HI range direct and ready for the next downshift, preselect LO range, push the range preselection lever down.

 CAUTION

When downshifting from HI range to LO range, the splitter control button must be in the rearward/direct position and the shift to the direct position completed before making the range shift. The shift to LO range cannot be made with the splitter control button in the forward/overdrive position.

7. Continue moving the shift lever, double-clutching, to the next desired gear position in LO range. As the shift lever passes through neutral, the transmission automatically shifts from HI range to LO range.
8. Continue downshifting, double-clutching, to the next desired gear position in LO range.

Lubrication

Proper lubrication procedures are the key to a good all-around maintenance program.

Fuller® Transmissions are designed so that the internal parts operate in an oil circulating bath created by the motion of the gears and shafts.

All parts will be properly lubricated if these procedures are closely followed:

- Maintain oil level. Inspect regularly.
- Follow maintenance interval chart.
- Use the correct grade and type of oil.
- Buy from a reputable dealer.

For additional lubrication information, see TCMT0021.

Maintain Proper Oil Level

Make sure oil is level with the filler opening. Being able to reach oil with your finger does not mean oil is at proper level. **(One inch of oil level is about one gallon of oil.)**

When adding oil, never mix engine oils and gear oils in the same transmission.

Oil Level

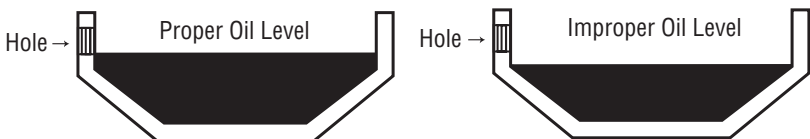

Service and Maintenance

Oil Filter

HIGHWAY USE	
For transmissions equipped with oil filter, P/N 4304827	Inspect filter for leaks or damage replace as necessary.
OFF-HIGHWAY USE	
For transmissions equipped with oil filter, P/N 4304827	Change filter every two years

If your vehicle has a transmission oil filter, you must change the filter when fluid or lubricant is changed.

The use of lubricants not meeting these requirements will affect warranty coverage.

Additives and friction modifiers must not be introduced. Never mix engine oils & gear oils in the same transmission.

For a list of Eaton Approved Synthetic Lubricants see TCMT0020, or call 1-800-826-HELP (4357).

Buy from a reputable dealer

For a complete list of approved and reputable dealers see TCMT0020, or write to:

Eaton Corporation
Truck Components
Global Marketing Services
P.O. Box 4013
Kalamazoo, MI 49003
www.roadranger.com

Transmission Operating Angles

If the transmission operating angle is more than 12 degrees, improper lubrication will occur. The operating angle is the transmission mounting angle in the chassis plus the percent of upgrade (expressed in degrees).

For operating angles over 12 degrees, the transmission must be equipped with an oil pump or cooler kit to insure proper lubrication.

Operating Temperatures with Oil Coolers

The transmission must not be operated consistently at temperatures above 250°F. However, intermittent operating temperatures to 300°F do not harm the transmission. Operating temperatures above 250°F increases the lubricant's oxidation rate and shortens its effective life. When the average operating temperature is above 250°F, the transmission can require more frequent oil changes or external cooling.

The following conditions in any combination can cause operating temperatures of over 250°F:

- Operating consistently at slow speed.
- High ambient temperatures.
- Restricted air flow around transmission.
- Exhaust system too close to transmission.
- High horsepower operation.

External oil coolers are available to reduce operating temperatures when the above conditions are encountered.

Service and Maintenance

Oil Cooler Chart

Transmission Oil Coolers are:
Recommended
<ul style="list-style-type: none">• With engines of 350 H.P. and above.
Required
<ul style="list-style-type: none">• With engines 399 H.P. and above and GCW's over 90,000 lbs.
<ul style="list-style-type: none">• With engines 399 H.P. and above and 1400 lbs. ft. or greater torque.
<ul style="list-style-type: none">• With engines 450 H.P. and above.

Preventive Maintenance

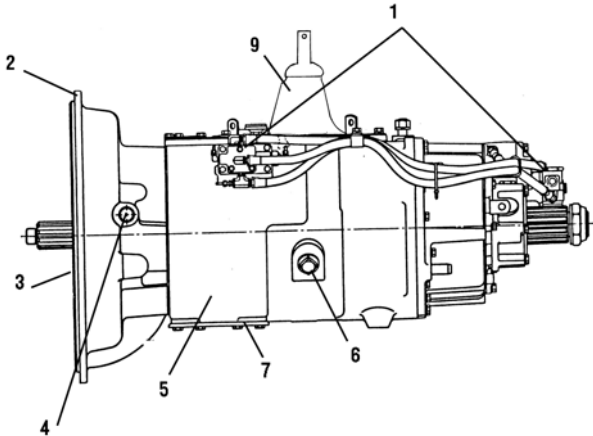

Note: Item numbers refer to the illustration.

1. Air System and Connections
 - Check for leaks, worn air lines, loose connections and cap-screws.
2. Clutch Housing Mounting
 - Check all capscrews of the clutch housing flange for looseness.
3. Clutch Release Bearing (Not Shown)
 - Remove hand hole cover and check radial and axial clearance in release bearing.
 - Check relative positive of thrust surface of release bearing with thrust sleeve on push-type clutches.
4. Clutch Pedal Shaft and Bores
 - Pry upward on shafts to check wear.
 - If excessive movement is found, remove clutch release mechanism and check bushing on bores and wear on shafts.

Service and Maintenance

5. Lubricant
 - Change at specified service intervals.
 - Use only the types and grades recommended.
6. Filler and Drain Plugs
 - Remove filler plugs and check level of lubricant at specified intervals. Tighten filler and drain plugs securely.
7. Capscrews and Gaskets
 - Check all capscrews, especially those on P.T.O. covers and rear bearing covers for looseness which would cause oil leakage.
 - Check P.T.O. opening and rear bearing covers for oil leakage due to faulty gasket.
8. Shift Lever
 - Check for looseness and free play in housing. If lever is loose in housing, proceed with check number 9.
9. Shift Lever Housing Assembly
 - Remove air lines at slave valve and remove the shift lever housing assembly from transmission.
 - Check tension spring and washer for set and wear.
 - Check the shift lever spade pin and slot for wear.
 - Check bottom end of shift lever for wear and check slot yokes and blocks in shift bar housing for wear at contact points with shift lever.

Definitions/Glossary of Terms for Transmission Operation

The following terms are used in describing the transmission operating procedures.

Break Torque	Releasing engine power or load from the transmission and drivetrain by releasing throttle or depressing clutch pedal.
Double-Clutch	The shifting technique used when moving the shift lever to the next lever position. Procedures: Depress clutch pedal, move lever to neutral, let up clutch pedal, accelerate or decelerate engine to obtain synchronous, depress clutch pedal again, and move lever into gear.
Preselect	Moving the shift button just prior to starting the shift. The shift button should not be moved while the shift lever is in neutral.
Ratio Step	Amount of change between two gear ratios expressed as a percentage. Example: The ratio step from 1st gear to 2nd gear is 35%.
Shift Button	The button on the side of the shift knob used to change gears.
Synchronous	The point at which the input gearing speed (engine speed) matches the output gearing speed (road speed) and a shift can occur without grinding.

Copyright Eaton Corporation, 2012. Eaton hereby grant their customers, vendors, or distributors permission to freely copy, reproduce and/or distribute this document in printed format. It may be copied only in its entirety without any changes or modifications. THIS INFORMATION IS NOT INTENDED FOR SALE OR RESALE, AND THIS NOTICE MUST REMAIN ON ALL COPIES.

Note: Features and specifications listed in this document are subject to change without notice and represent the maximum capabilities of the software and products with all options installed. Although every attempt has been made to ensure the accuracy of information contained within, Eaton makes no representation about the completeness, correctness or accuracy and assumes no responsibility for any errors or omissions. Features and functionality may vary depending on selected options.

For spec'ing or service assistance, call 1-800-826-HELP (4357) or visit www.eaton.com/roadranger. In Mexico, call 001-800-826-4357.

Roadranger: Eaton and trusted partners providing the best products and services in the industry, ensuring more time on the road.

Eaton Corporation

Vehicle Group
P.O. Box 4013
Kalamazoo, MI 49003 USA
800-826-HELP (4357)
www.eaton.com/roadranger

Printed in USA



BACKED BY
Roadranger
SUPPORT