

# Aluminum & Stainless Steel



## Aluminum

Aluminum channels, fittings and accessories offer excellent corrosion resistance and are suitable for many indoor and outdoor applications. Aluminum's high strength to weight ratio helps greatly reduce overall cost of installation through ease of handling and cutting. Channels are extruded from aluminum alloy 6063-T6. Closure strips are extruded from aluminum alloy 6063-T5. Fittings and accessories are made from aluminum alloy 5052-H32.

## Stainless Steel

Where corrosion problems persist and other material and fittings are ineffective, we recommend use of corrosion resistant stainless steel channels and accessories. Channels and fittings are available in two types of stainless steel:

SS4-AISI Type 304

SS6-AISI Type 316

## Fittings

Most fittings, as shown in this catalog, can be supplied in aluminum or stainless steel. Consult factory for possible minimum production quantities and set-up charges.

## Load Data

### Aluminum

Channel's approximate load data can be determined by multiplying load data in the steel channel section of this catalog by a factor of 0.38.

### Stainless Steel

Channel load data is the same as the data in the steel channel section of this catalog.

## Metric

Metric dimensions are shown in parentheses. Unless noted, all metric dimensions are in millimeters.

# Aluminum Channel & Closure Strips

## B11AL

- Thickness: .105 (2.6 mm)
- Standard Length: 10' (3.05 m) and 20' (6.09 m)
- Material: Aluminum
- Weight: 1.06 Lbs./Ft. (1.58 kg/m)

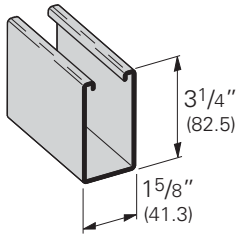

## B12AL

- Thickness: .105 (2.6 mm)
- Standard Length: 10' (3.05 m) and 20' (6.09 m)
- Material: Aluminum
- Weight: .86 Lbs./Ft. (1.28 kg/m)

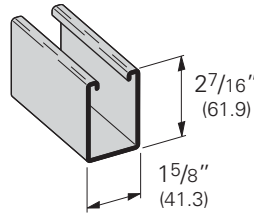

## B22AL

- Thickness: .105 (2.6 mm)
- Standard Length: 10' (3.05 m) and 20' (6.09 m)
- Material: Aluminum
- Weight: .66 Lbs./Ft. (0.98 kg/m)

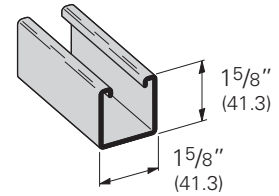

## B22AAL

- Thickness: .105 (2.6 mm)
- Standard Length: 10' (3.05 m) and 20' (6.09 m)
- Material: Aluminum
- Weight: 1.18 Lbs./Ft. (1.75 kg/m)

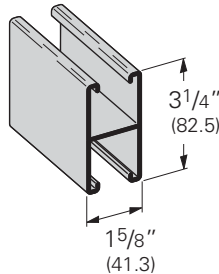

## B24AL

- Thickness: .080 (2.0 mm)
- Standard Length: 10' (3.05 m) and 20' (6.09 m)
- Material: Aluminum
- Weight: .52 Lbs./Ft. (0.77 kg/m)

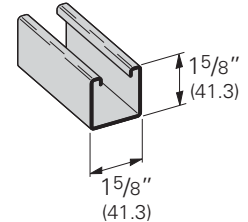

## B54AL

- Thickness: .080 (2.0 mm)
- Standard Length: 10' (3.05 m) and 20' (6.09 m)
- Material: Aluminum
- Weight: .37 Lbs./Ft. (0.55 kg/m)

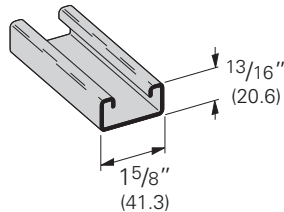

## B54AAL

- Thickness: .080 (2.0 mm)
- Standard Length: 10' (3.05 m) and 20' (6.09 m)
- Material: Aluminum
- Weight: .57 Lbs./Ft. (0.84 kg/m)

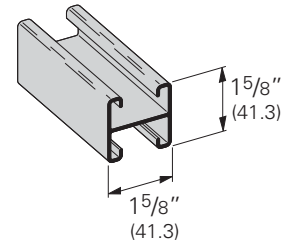

## B217AL Closure Strip

- Standard Length: 10' (304.8 cm)
- Material: Aluminum
- Weight: .15 Lbs./Ft. (0.23 kg/m)

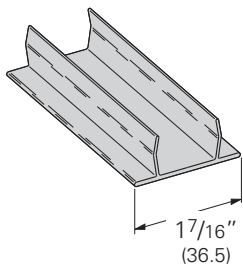

## B217P Plastic Closure Strip

- Standard Length: 10' (304.8 cm)
- Material: PVC
- Weight: .09 Lbs./Ft. (0.14 kg/m)

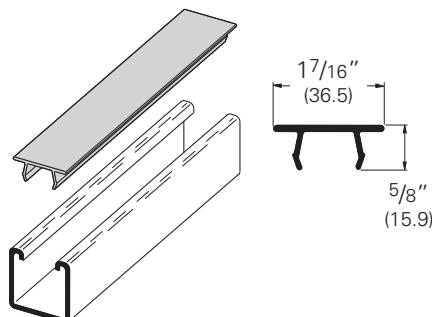

## B217FFAL Closure Strip

- Standard Length: 10' (304.8 cm)
- Material: Aluminum
- Weight: .16 Lbs./Ft. (0.24 kg/m)

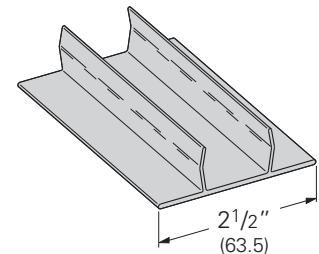

Reference page 218 for general fitting specifications. Other channel combinations available-see steel section for styles.

# Aluminum

## SH Type Channel

- Material: Aluminum

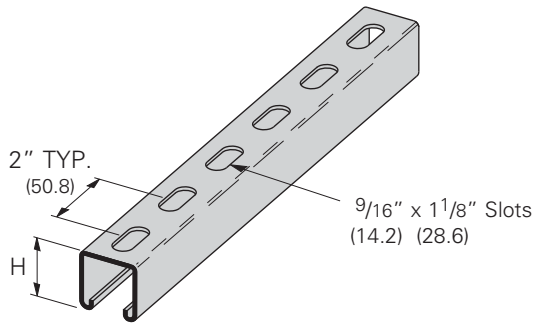

Part No.	Thickness		H		Wt./C	
	in.	mm	in.	mm	Lbs./Ft.	kg/m
<b>B12SH AL</b>	.105	(2.6)	27/16"	(61.9)	.83	(1.23)
<b>B22SH AL</b>	.105	(2.6)	15/8"	(41.3)	.63	(.93)
<b>B24SH AL</b>	.080	(2.0)	15/8"	(41.3)	.49	(.73)
<b>B54SH AL</b>	.080	(2.0)	13/16"	(20.6)	.34	(.50)

## H-17/8 Type Channel

- Material: Aluminum

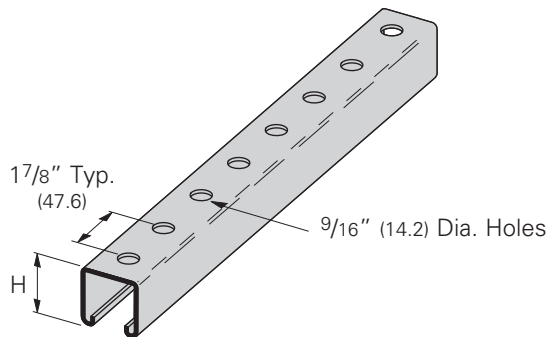

Part No.	Thickness		H		Wt./C	
	in.	mm	in.	mm	Lbs./Ft.	kg/m
<b>B12H17/8 AL</b>	.105	(2.6)	27/16"	(61.9)	.86	(1.28)
<b>B22H17/8 AL</b>	.105	(2.6)	15/8"	(41.3)	.66	(.98)
<b>B24H17/8 AL</b>	.080	(2.0)	15/8"	(41.3)	.52	(.77)
<b>B54H17/8 AL</b>	.080	(2.0)	13/16"	(20.6)	.37	(.55)

## KO6 Type Knockout Channel

- Material: Aluminum

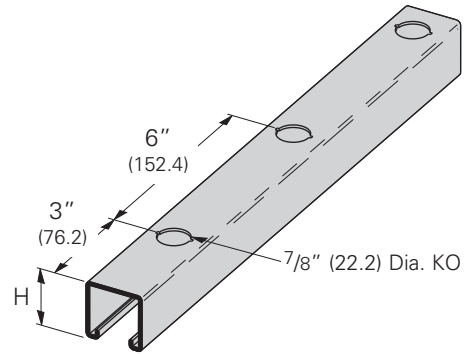

Part No.	Thickness		H		Wt./C	
	in.	mm	in.	mm	Lbs./Ft.	kg/m
<b>B12KO6 AL</b>	.105	(2.6)	27/16"	(61.9)	.86	(1.28)
<b>B22KO6 AL</b>	.105	(2.6)	15/8"	(41.3)	.66	(.98)
<b>B24KO6 AL</b>	.080	(2.0)	15/8"	(41.3)	.52	(.77)
<b>B54KO6 AL</b>	.080	(2.0)	13/16"	(20.6)	.37	(.56)

## B2000 Series Rigid Conduit Clamps

- Safety Factor of 5
- Machine Screw and Square Nut included
- Pipe clamp material 5052-H32

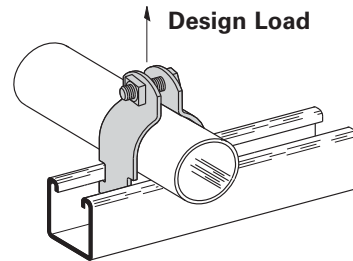

Part No.	Conduit or Pipe Size		Material Thickness	Design Load		Wt./C		
	in.	mm		Lbs.	kN	Lbs.	kg	
<b>B2001 AL</b>	3/8"	(10)	.063	(1.6)	180	(.80)	4	(1.8)
<b>B2008 AL</b>	1/2"	(15)	.063	(1.6)	180	(.80)	4	(1.8)
<b>B2009 AL</b>	3/4"	(20)	.080	(2.0)	270	(1.20)	6	(2.7)
<b>B2010 AL</b>	1"	(25)	.080	(2.0)	270	(1.20)	7	(3.2)
<b>B2011 AL</b>	1 1/4"	(32)	.080	(2.0)	270	(1.20)	8	(3.6)
<b>B2012 AL</b>	1 1/2"	(40)	.100	(2.5)	360	(1.60)	11	(5.0)
<b>B2013 AL</b>	2"	(50)	.100	(2.5)	360	(1.60)	12	(5.4)
<b>B2014 AL</b>	2 1/2"	(65)	.100	(2.5)	360	(1.60)	13	(5.9)
<b>B2015 AL</b>	3"	(80)	.100	(2.5)	360	(1.60)	16	(7.2)
<b>B2016 AL</b>	3 1/2"	(90)	.125	(3.2)	450	(2.00)	22	(10.0)
<b>B2017 AL</b>	4"	(100)	.125	(3.2)	450	(2.00)	24	(10.9)
<b>B2018 AL</b>	4 1/2"	(115)	.125	(3.2)	450	(2.00)	26	(11.8)
<b>B2019 AL</b>	5"	(125)	.125	(3.2)	450	(2.00)	27	(12.2)
<b>B2020 AL</b>	6"	(150)	.125	(3.2)	450	(2.00)	33	(14.9)

Reference page 218 for general fitting specifications. Other channel combinations available-see steel section for styles.

## Aluminum Fittings

Most fittings, as shown in this catalog, can be supplied in aluminum. See "Fittings" section (page 106) of this catalog. Consult factory for possible minimum production quantities and set-up charges.

### Channel Nuts

We recommend the use of Stainless Steel channel nuts with Aluminum channel. For channel nut pull-out strength and slip resistance, use the channel nut information provided on pg. 84 & 85.

A (.70) multiplier is to be applied to obtain the appropriate derated values for aluminum channel.

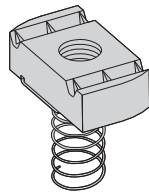

**Spring Nut**

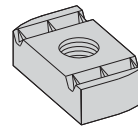

**Nut Without Spring**

### Nuts for B12 Channel

Part Number		Thread Size	Thickness		Wt./C	
With Spring	Without Spring		in.	mm	Lbs.	kg
N724SS6	N224WOSS6	1/4"-20	1/4"	(6.3)	6.6	(3.0)
N728SS6	N228WOSS6	3/8"-16	3/8"	(9.5)	10.6	(4.8)
N725SS6	N225WOSS6	1/2"-13	3/8"	(9.5)	9.7	(4.4)

### Nuts for B22, B24 Channels

Part Number		Thread Size	Thickness		Wt./C	
With Spring	Without Spring		in.	mm	Lbs.	kg
N224SS6	N224WOSS6	1/4"-20	1/4"	(6.3)	6.6	(3.0)
N228SS6	N228WOSS6	3/8"-16	3/8"	(9.5)	10.6	(4.8)
N225SS6	N225WOSS6	1/2"-13	3/8"	(9.5)	9.7	(4.4)

### Nuts for B54 Channel

Part Number		Thread Size	Thickness		Wt./C	
With Spring	Without Spring		in.	mm	Lbs.	kg
N524SS6	N224WOSS6	1/4"-20	1/4"	(6.3)	6.6	(3.0)
N528SS6	N228WOSS6	3/8"-16	3/8"	(9.5)	10.6	(4.8)
N525SS6	N525WOSS6	1/2"-13	3/8"	(9.5)	9.7	(4.4)

Reference page 218 for general fitting specifications. Other channel combinations available-see steel section for styles.

# Stainless Steel

## B22SS

- Substitute 4 for Stainless Steel Type 304 or 6 for Stainless Steel Type 316
- Thickness: 12 Ga. (2.6 mm)
- Standard Length: 10' (3.05 m) and 20' (6.09 m)
- Material: SS4, SS6
- Weight: 1.90 Lbs./Ft. (2.83 kg/m)

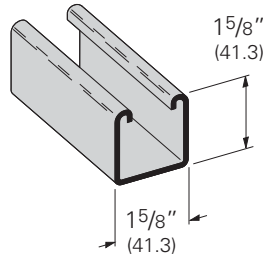

## B24SS

- Substitute 4 for Stainless Steel Type 304 or 6 for Stainless Steel Type 316
- Thickness: 14 Ga. (1.9 mm)
- Standard Length: 10' (3.05 m) and 20' (6.09 m)
- Material: SS4, SS6
- Weight: 1.40 Lbs./Ft. (2.08 kg/m)

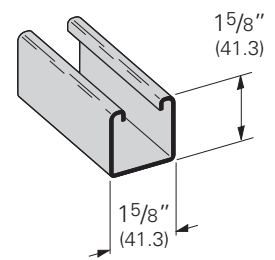

## B32SS4

- Thickness: 12 Ga. (2.6 mm)
- Standard Length: 10' (3.05 m) and 20' (6.09 m)
- Material: SS4
- Weight: 1.70 Lbs./Ft. (2.53 kg/m)

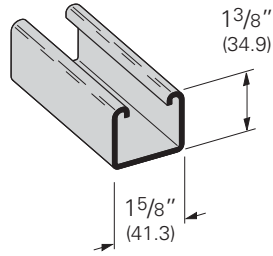

## B42SS4

- Thickness: 12 Ga. (2.6 mm)
- Standard Length: 10' (3.05 m) and 20' (6.09 m)
- Material: SS4
- Weight: 1.44 Lbs./Ft. (2.14 kg/m)

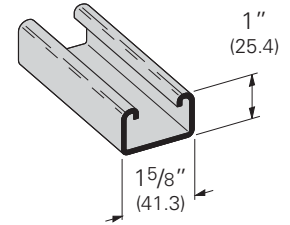

## B52SS

- Substitute 4 for Stainless Steel Type 304 or 6 for Stainless Steel Type 316
- Thickness: 12 Ga. (2.6 mm)
- Standard Length: 10' (3.05 m) and 20' (6.09 m)
- Material: SS4, SS6
- Weight: 1.27 Lbs./Ft. (1.89 kg/m)

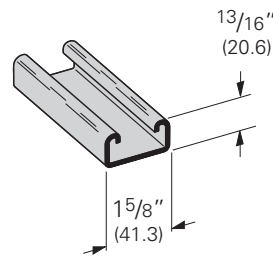

## B54SS

- Substitute 4 for Stainless Steel Type 304 or 6 for Stainless Steel Type 316
- Thickness: 14 Ga. (1.9 mm)
- Standard Length: 10' (3.05 m) and 20' (6.09 m)
- Material: SS4, SS6
- Weight: .97 Lbs./Ft. (1.44 kg/m)

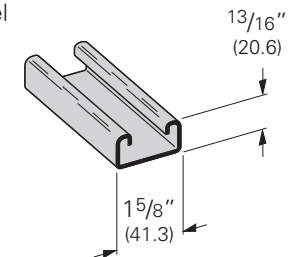

## SH Type Channel

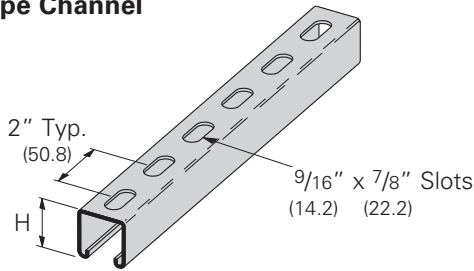

## H-17/8 Type Channel

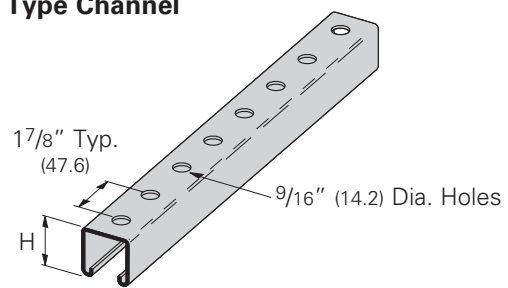

Part No.	Thickness		H		Wt./C	
	in.	mm	in.	mm	Lbs./Ft.	kg/m
B22SH SS4	12 Ga.	(2.6)	1 5/8"	(41.3)	1.82	(2.70)
B22SH SS6	12 Ga.	(2.6)	1 5/8"	(41.3)	1.82	(2.70)
B24SH SS4	14 Ga.	(1.9)	1 5/8"	(41.3)	1.34	(1.99)
B24SH SS6	14 Ga.	(1.9)	1 5/8"	(41.3)	1.34	(1.99)
B32SH SS4	12 Ga.	(2.6)	1 3/8"	(34.9)	1.62	(2.41)
B42SH SS4	12 Ga.	(2.6)	1"	(25.4)	1.36	(2.02)
B52SH SS4	12 Ga.	(2.6)	1 3/16"	(20.6)	1.23	(1.83)
B52SH SS6	12 Ga.	(2.6)	1 3/16"	(20.6)	1.23	(1.83)
B54SH SS4	14 Ga.	(1.9)	1 3/16"	(20.6)	.91	(1.35)
B54SH SS6	14 Ga.	(1.9)	1 3/16"	(20.6)	.91	(1.35)

Part No.	Thickness		H		Wt./C	
	in.	mm	in.	mm	Lbs./Ft.	kg/m
B22H17/8 SS4	12 Ga.	(2.6)	1 5/8"	(41.3)	1.85	(2.75)
B22H17/8 SS6	12 Ga.	(2.6)	1 5/8"	(41.3)	1.85	(2.75)
B24H17/8 SS4	14 Ga.	(1.9)	1 5/8"	(41.3)	1.36	(2.02)
B24H17/8 SS6	14 Ga.	(1.9)	1 5/8"	(41.3)	1.36	(2.02)
B32H17/8 SS4	12 Ga.	(2.6)	1 3/8"	(34.9)	1.65	(2.45)
B42H17/8 SS4	12 Ga.	(2.6)	1"	(25.4)	1.39	(2.07)
B52H17/8 SS4	12 Ga.	(2.6)	1 3/16"	(20.6)	1.20	(1.83)
B52H17/8 SS6	12 Ga.	(2.6)	1 3/16"	(20.6)	1.20	(1.83)
B54H17/8 SS4	14 Ga.	(1.9)	1 3/16"	(20.6)	.93	(1.38)
B54H17/8 SS6	14 Ga.	(1.9)	1 3/16"	(20.6)	.93	(1.38)

Reference page 218 for general fitting specifications. Other channel combinations available-see steel section for styles.

## Stainless Steel Fittings

Most fittings, as shown in this catalog, can be supplied in Type 304 or Type 316 stainless steel. See "Fittings" section (page 106) of this catalog.  
Consult factory for possible minimum production quantities and set-up charges.

### B2000 Series Pipe & Tubing Clamps

- Safety Factor of 5
- Combination recess hex head machine screw and square nut included
- Material: Stainless Steel Type 304 & 316

Part No.	Conduit or Pipe Size		Material Thickness		Design Load		Wt./C	
	in.	mm	in.	mm	Lbs.	kN	Lbs.	kg
<b>B2001 SS4</b>	3/8"	(10)	16 Ga.	(1.5)	400	(1.78)	10	(4.5)
<b>B2008 SS4</b>	1/2"	(15)	16 Ga.	(1.5)	400	(1.78)	11	(5.0)
<b>B2009 SS4</b>	3/4"	(20)	14 Ga.	(1.9)	600	(2.67)	15	(6.8)
<b>B2010 SS4</b>	1"	(25)	14 Ga.	(1.9)	600	(2.67)	16	(7.2)
<b>B2011 SS4</b>	1 1/4"	(32)	14 Ga.	(1.9)	600	(2.67)	20	(9.1)
<b>B2012 SS4</b>	1 1/2"	(40)	12 Ga.	(2.6)	800	(3.56)	30	(13.6)
<b>B2013 SS4</b>	2"	(50)	12 Ga.	(2.6)	800	(3.56)	34	(15.4)
<b>B2014 SS4</b>	2 1/2"	(65)	12 Ga.	(2.6)	800	(3.56)	38	(17.2)
<b>B2015 SS4</b>	3"	(80)	12 Ga.	(2.6)	800	(3.56)	44	(19.9)
<b>B2016 SS4</b>	3 1/2"	(90)	12 Ga.	(2.6)	1000	(4.45)	51	(23.1)
<b>B2017 SS4</b>	4"	(100)	12 Ga.	(2.6)	1000	(4.45)	55	(24.9)
<b>B2018 SS4</b>	4 1/2"	(115)	12 Ga.	(2.6)	1000	(4.45)	59	(26.7)
<b>B2019 SS4</b>	5"	(125)	12 Ga.	(2.6)	1000	(4.45)	64	(29.0)
<b>B2020 SS4</b>	6"	(150)	12 Ga.	(2.6)	1000	(4.45)	80	(36.3)

Design Load

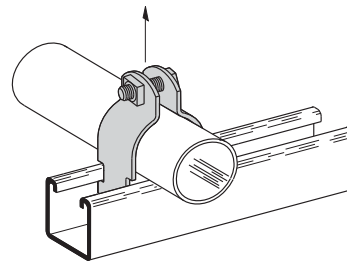

### Channel Nuts

- For Channel Nuts pull-out strength and slip resistance, use the data shown on pages 84 & 85.

Note: Reduce slip load by 50% due to hardness of material.

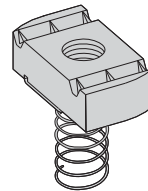

Spring Nut

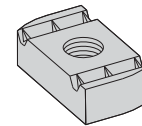

Nut Without Spring

### Nuts for B22, B24, B32 Channels

Part Number		Thread Size	Thickness		Wt./C	
With Spring	Without Spring		in.	mm	Lbs.	kg
<b>N224SS6</b>	<b>N224WOSS6</b>	1/4"-20	1/4"	(6.3)	6.6	(3.0)
<b>N228SS6</b>	<b>N228WOSS6</b>	3/8"-16	3/8"	(9.5)	10.6	(4.8)
<b>N225SS6</b>	<b>N225WOSS6</b>	1/2"-13	3/8"	(9.5)	9.7	(4.4)

### Nuts for B42, B52, B54 Channels

Part Number		Thread Size	Thickness		Wt./C	
With Spring	Without Spring		in.	mm	Lbs.	kg
<b>N524SS6</b>	<b>N224WOSS6</b>	1/4"-20	1/4"	(6.3)	6.6	(3.0)
<b>N528SS6</b>	<b>N228WOSS6</b>	3/8"-16	3/8"	(9.5)	10.6	(4.8)
<b>N525SS6</b>	<b>N525WOSS6</b>	1/2"-13	3/8"	(9.5)	9.7	(4.4)

Reference page 218 for general fitting specifications. Other channel combinations available-see steel section for styles.