

Wall studs

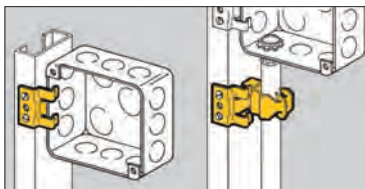

- Attaches with screws to metal studs.
- BB1 supports electrical box.
- BG series features Guide-Rite™ design.
- BP series features push-type design.

Box To Stud Fastener



UPC/Part Number	Catalog Number	Description	Box Qty.
78101118145	BB1	Electrical Box Support Clip	100

Guide-Rite Conduit To Stud Fastener



UPC/Part Number	Catalog Number	Conduit Size EMT & Rigid	Box Qty.
78101118420	BG-6-B1 *	3/8"	100
781011 18475	BG-8-12-B1	1/2", 3/4"	100
781011 18555	BG-16-B1	1"	100

Patent #4958792

* BG-6 will accept the following range $\varnothing.420 - \varnothing.675$:
14/2 thru 10/4 MC/AC cable and 5/16" or 3/8" flexible conduit

Push Type Conduit To Stud Fastener



UPC/Part Number	Catalog Number	Conduit Size	Box Qty.
781011 19245	BP-8-B1	1/2" EMT	100
781011 19345	BP-12-B1	3/4" EMT, 1/2" IMC, Rigid	100
781011 19440	BP-16-B1	1" EMT, 3/4" IMC, Rigid	100

Read safety/installation instruction sheets in packages before use.
These products are designed for positioning only. No load rating.

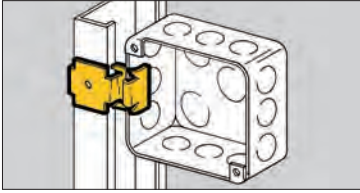

- Attaches electrical boxes (requiring plaster rings) to most metal studs.
- Box mounts flush to back of drywall.
- Simply installed with a hammer.

Box To Stud Fastener



UPC/Part Number	Catalog Number	Description	Box Qty.
78101118270	BB9	Electrical Box Support	100

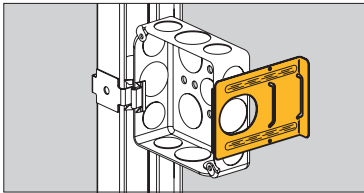

- Provides far-side support for electrical boxes in 2½" thru 6" studs.
- Cut outs facilitate bending to provide precise installation with greater stability.
- Easily snaps onto box side and is secured in place by plaster ring.

Adjustable Box Stabilizers



BB12



BB12-6

UPC/Part Number	Catalog Number	Metal Stud Size	Box Qty.
78101192876	BB12	2½" thru 4"	100
78101192879	BB12-6	6"	100

Read safety/installation instruction sheets in packages before use. These products are designed for positioning only. No load rating.

Wall studs

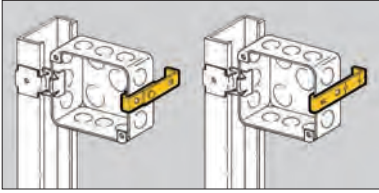

- Provides far-side support for electrical boxes.
- See BB12 Series (page 20) for a better solution.

Box Stabilizer

Wall Studs



BF1-96



BF1-64



BF1-56



BF1-40



UPC/Part Number	Catalog Number	Metal Stud Size	Box Qty.
78101118320	BF1-40	2½"	100
78101118325	BF1-56	3½"	100
78101118330	BF1-64	4"	100
78101118335	BF1-96	6"	100

Read safety/installation instruction sheets in packages before use. These products are designed for positioning only. No load rating.

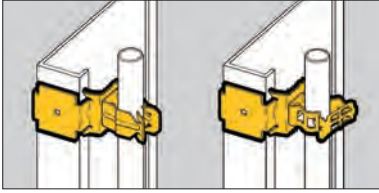

- Attaches conduit to most metal studs.
- BG Series features Guide-Rite™ design.
- BP Series feature push-type design.

Guide-Rite Conduit To Stud Fastener



UPC/Part Number	Catalog Number	Conduit Size EMT & Rigid	Box Qty.
78101118425	BG-6-B5 *	3/8" or BX	100
78101118480	BG-8-12-B5	1/2", 3/4"	100
78101118560	BG-16-B5	1"	100
78101118645	BG-20-B5	1 1/4"	50

Patent #4958792

* BG-6 will accept the following range $\varnothing.420 - \varnothing.675$:
14/2 thru 10/4 MC/AC cable and 5/8" or 3/8" flexible conduit

Push Type Conduit To Stud Fastener



UPC/Part Number	Catalog Number	Conduit Size	Box Qty.
78101119250	BP-8-B5	1/2" EMT	100
78101119350	BP-12-B5	3/4" EMT, 1/2" IMC, Rigid	100
78101119445	BP-16-B5	1" EMT, 3/4" IMC, Rigid	100

Wall studs

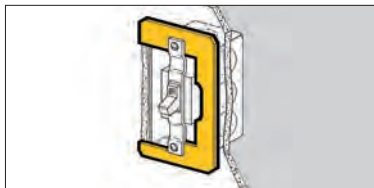

- BB32 adds rigidity to devices in oversize wall openings.
- Holds wiring device firmly in drywall.
- Can be used with switches, receptacles, GFCIs and decorator devices.
- Ideal for positioning devices in pre-fab installations.
- Finish: Pre-Galvanized.

Retainer Level



UPC/Part Number	Catalog Number	Description	Box Qty.
78101118215	BB32	Adds Rigidity to Oversize Wall Openings	100



- Attaches electrical boxes to finished drywall.
- Box is completely supported by drywall.
- Prevents box from pulling out of wall.
- Finish: Pre-Galvanized.

Box Support

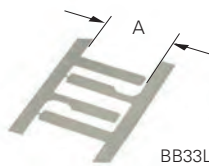
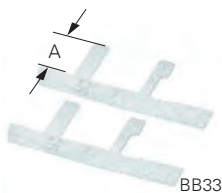

UPC/Part Number	Catalog Number	Description	Length A	Box Qty.
78101101138	BB33	Box Support	1½"	100 pr.
78101104936	BB33L	Long Leg Box Support	2½"	100

Read safety/installation instruction sheets in packages before use. These products are designed for positioning only. No load rating.

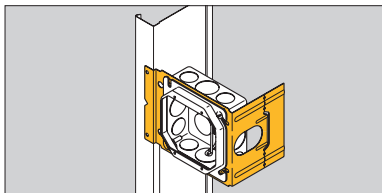

Box Support Brackets



- Improved far-side support stands up during drywall installation and out performs competitor brackets.
- Supports 4" or 4¹/₁₆" square boxes.
- Brackets may be piggy-backed in series.
- Finish: Pre-Galvanized.
- Contact factory for pre-fab box assemblies.

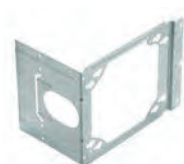

BB4-23



BB4-4



BB4-6



BB4-23D



BB4-4D



BB4-6D

UPC/Part Number	Catalog Number	Metal Stud Size	Box Qty.
78101118190	BB4-23	3 ⁵ / ₈ ", 2 ¹ / ₂ "	100
78101118200	BB4-4	4", 3 ⁵ / ₈ ", 2 ¹ / ₂ "	100
78101118202	BB4-6	6", 5 ¹ / ₂ ", 3 ⁵ / ₈ ", 2 ¹ / ₂ "	100
79903848375	BB4-23D	3 ⁵ / ₈ ", 2 ¹ / ₂ "	50
79903848376	BB4-4D	4", 3 ⁵ / ₈ ", 2 ¹ / ₂ "	50
79903848377	BB4-6D	6", 5 ¹ / ₂ ", 3 ⁵ / ₈ ", 2 ¹ / ₂ "	50

Read safety/installation instruction sheets in packages before use. These products are designed for positioning only. No load rating.

Wall studs

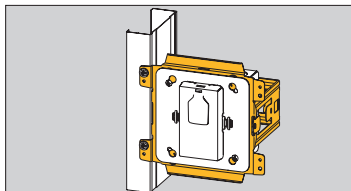

Box Support Brackets

- Interlocking wrap-around design provides extra rigidity.
- Supports most standard 1-gang and 2-gang US and Canadian boxes and/or plaster rings 4" SQ., 4¹/₁₆" SQ., and 5" SQ. on either side of the stud.



- Adjustable for varying stud depths (2¹/₂" to 6").
- Compatible with 1-gang and 2-gang Rapid Ring™ and adjustable plaster rings.
- Integral mounting tabs for attaching plaster rings.
- Multiple brackets may be ganged together.
- Contact factory for pre-fab box assemblies.
- Finish: Pre-Galvanized.

U.S. Patents 9,444,236 & 9,780,545

BB70

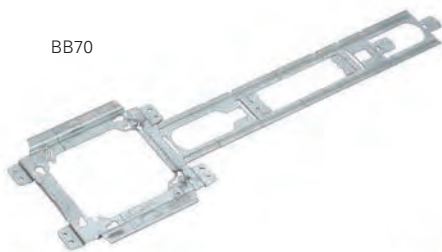

BB70E*
(Sold separately,
must be used with
BB70)



See following page for various product information.

UPC/Part Number	Catalog Number	Metal Stud Size	Box Qty.
79903856399	BB70	2 ¹ / ₂ " - 4"	50
79903856400	BB70E*	5 ¹ / ₂ " - 6"	50

* Must be used with BB70.



Can be used with
BBFS-18 (floor stand)
See page 32.

*Read safety/installation instruction sheets in packages before use.
These products are designed for positioning only. No load rating.*

Bend For Various Depths

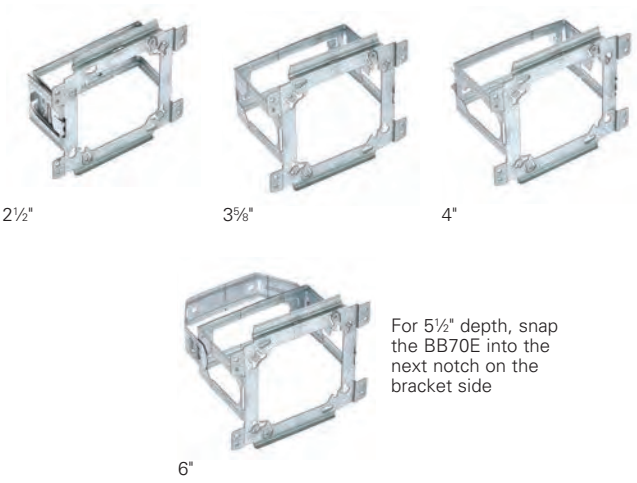

Bending Bracket for 3 5/8" depth



Read safety/installation instruction sheets in packages before use. These products are designed for positioning only. No load rating.

Wall studs

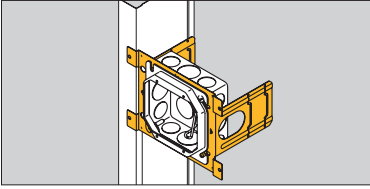

Double-Sided Box Support Bracket w/ Marty-Mouse Ears



- Double-side box support, designed for Pre-Fab. Unit can be installed on either side of stud without repositioning box or devices.
- Patented Marty Mouse™ ears feature an innovative keyhole pattern to secure outlet box to bracket with or without the plaster ring.
- Wider box opening accommodates one or two gang adjustable plaster rings (B1AJ & B2AJ).
- Enhanced far-side support stands up during drywall installation and outperforms competitor brackets.
- Contact factory for pre-fab box assemblies.
- Finish: Pre-Galvanized.

1. Bracket is shipped with ear tabs in the open position

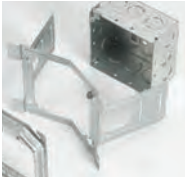

2. Insert box screws into open slots



3. When plaster ring is installed, the ear tabs are bent down into the closed position



4. With the tabs closed, the box remains secured to the bracket when the plaster ring is removed



UPC/Part Number	Catalog Number	Stud Size	Box Qty.
78205138645	BB73	3 ⁵ / ₈ " , 2 ¹ / ₂ "	50
78205138717	BB74	4" , 3 ⁵ / ₈ " , 2 ¹ / ₂ "	50
78205138759	BB76	6" , 5 ¹ / ₂ " , 3 ⁵ / ₈ " , 2 ¹ / ₂ "	25

Patent # 5595362

Read safety/installation instruction sheets in packages before use. These products are designed for positioning only. No load rating.

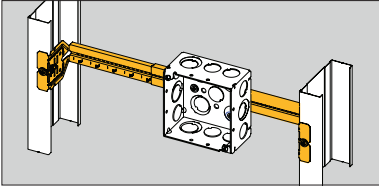

Telescoping Box Mounting Bracket



- Completely adjustable fits a range of stud spacings
- Mounts 1½", 2⅛", 2½", and 2⅜" deep boxes
- Increased rigidity through center groove design
- Only two screws required to mount for 1½" and 2⅛" box depths
- Pre-punched screw holes provide for easy box installation.
- Bar is marked with scale for stud spacing.
- Finish: Pre-Galvanized.



BB2-24T

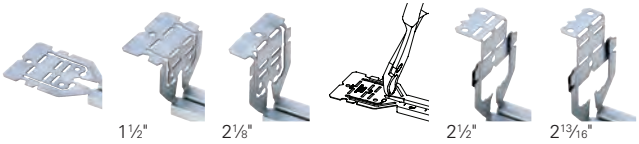

UPC/Part Number	Catalog Number	Metal Stud Spacing	Box Qty.
79903863001	BB2-16T	11" to 18"	50
79903863002	BB2-24T	15½" to 26"	50

Patent pending.

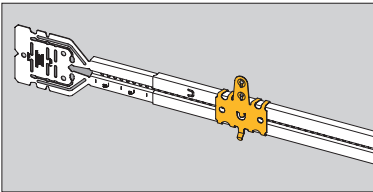

Box Mounting Clip



- Allows for pre-fabrication of the electrical box prior to installing the box onto the bracket
- Tool-less, simply installs by snapping onto the bracket and requires no hardware to secure
- Contact factory for pre-fab box assemblies.



BB2TSC

UPC/Part Number	Catalog Number	Stud Spacing	Box Qty.
79903863003	BB2TSC	Box Mounting Clip	100

Patent pending.

Read safety/installation instruction sheets in packages before use. These products are designed for positioning only. No load rating.

Wall studs

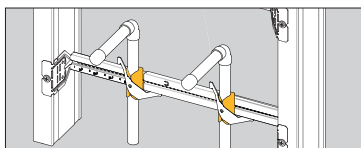
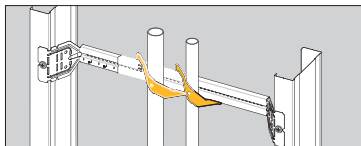

- Pipe/conduit clamps require no hardware to install and help provide support anywhere between the stud
- Copper pipe insulator sleeves help provide protection of differing metals



Box Mounting Accessories

UPC/Part Number	Catalog Number	Description	Box Qty.
79903863004	BB2TPC-038	Pipe/Conduit Clamp $\frac{3}{8}$ "	100
79903863005	BB2TPC-050	Pipe/Conduit Clamp $\frac{1}{2}$ "	100
79903863006	BB2TPC-075	Pipe/Conduit Clamp $\frac{3}{4}$ "	100
79903863007	BB2TPC-100	Pipe/Conduit Clamp 1"	100
79903863013	BB2TCT-050	Copper Pipe Insulator Sleeve $\frac{1}{2}$ "	100
79903863015	BB2TCT-075	Copper Pipe Insulator Sleeve $\frac{3}{4}$ "	100
79903863016	BB2TCT-100	Copper Pipe Insulator Sleeve 1"	100

U.S. Patent 9,791,073

Note: Secures to B-Line BB2-16T and BB2-24T telescoping brackets only. For a standard $2\frac{1}{8}$ " deep box, the stud depth must be $3\frac{1}{2}$ " or greater. For a shallow $1\frac{1}{2}$ " deep box, the stud depth must be $2\frac{1}{2}$ " or greater.

Mounting Screws



BWHS-9



BWHS-9D

UPC/Part Number	Catalog Number	Description	Box Qty.
78101101675	BWHS-9	#8 x $\frac{9}{16}$ " Sheet Metal Screw	1000
78101104925	BWHS-9D	#8 x $\frac{9}{16}$ " Self-Drilling Sheet Metal Screw	1000

Note: BWHS-9 & BWHS-9D can be used with all fasteners requiring attachment with sheet metal screws, except on BB2-16, BB2-16D, BB2-24 & BB2-24D which only BWHS-9 can be used.

Read safety/installation instruction sheets in packages before use. These products are designed for positioning only. No load rating.

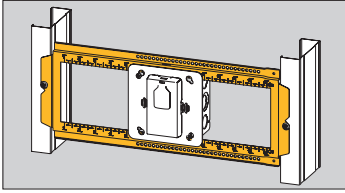

Open Box Mounting Bracket



BB7-24

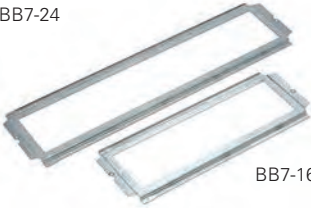

BB7-16

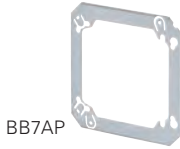

BB7AP

- Open box support allows for adjustability of box position between studs.
- Supports most US and Canadian boxes and/or plaster rings 4" SQ., 4^{11/16}" SQ., 5" SQ., and multi-gang boxes.
- Fits up to 1½" wide studs 16" to 24" on center.
- Compatible with Rapid Ring™ & adjustable plaster rings.
- Field cut to adjust to non-standard stud spacings.
- Stamped markings at ¼", ½", and 1" increments to allow the installer to easily locate the desired box position.
- Contact factory for pre-fab box assemblies.
- Finish: Pre-Galvanized.

*U.S. patents: 9,444,236 & 9,780,545.
Other patents pending.*

UPC/Part Number	Catalog Number	Description	Box Qty.
79903856401	BB7-16	16" Stud Spacing	25
79903856402	BB7-24	24" Stud Spacing	25
79903859494	BB7AP	Alignment Plate	100

Can be cut on a mark to make shorter length brackets.

Can be used with BBFS-18 (floor stand) See pages 32 & 33.



*Read safety/installation instruction sheets in packages before use.
These products are designed for positioning only. No load rating.*

Wall studs

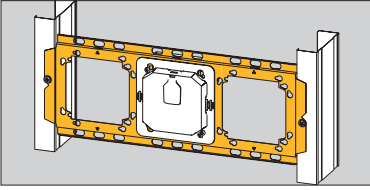

Box Mounting Bracket



- Increased strength and rigidity to help withstand the stress of drywall installation.
- Supports most US & Canadian boxes and plaster rings 4" SQ. and 4 1/16" SQ.
- Compatible with 1-gang and 2-gang Rapid Ring™ and adjustable plaster rings.
- Contact factory for pre-fab box assemblies.
- Finish: Pre-Galvanized.
U.S. Patent 9,653,899

Wall Studs

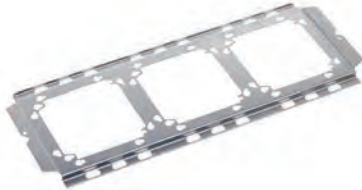

BB8-16



BB8-24

UPC/Part Number	Catalog Number	Description	Box Qty.
78101102898	BB8-16	16" Stud Spacing	25
78101102900	BB8-24	24" Stud Spacing	25

Read safety/installation instruction sheets in packages before use. These products are designed for positioning only. No load rating.

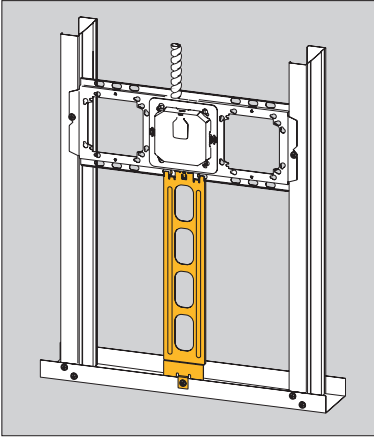

- Bracket accessories require no tools to install.
- BBFS-18 floor stand ensures consistent box height and eliminates need to measure for proper install height.
- Can be used with BB7 (page 30) and BB8 (page 31) brackets.
- Finish: Pre-Galvanized.
U.S. Patent 9,653,899

Box Mounting Bracket Accessories

BBFS-18 Installed (Can be used with BB7 or BB8 brackets)



BBFS-18

UPC/Part Number	Catalog Number	Description	Box Qty.
79903851597	BBFS-18	Floor Stand	25

Read safety/installation instruction sheets in packages before use. These products are designed for positioning only. No load rating.

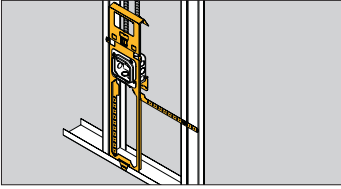

Floor-Mount Box Support



BBF15



BBFC



BBF18



BBF24



BBFxxC

- New BBF floorstand provides the most rigid support in the industry.
- Far-side support accommodates 6", 5½", 3⅝", and 2½" stud depths.
- Fold-out tab built-in to attach floor stand to stud if desired.
- Integral "wings" provide rigid support when floorstand is mounted between studs.
- Optional cable containment clip securely attaches to floorstand without hardware.
- Patented Marty Mouse™ ears enable boxes to be secured in place with or without the plaster rings.
- Finish: Pre-Galvanized.
- Contact factory for pre-fab box assemblies.

UPC/Part Number	Catalog Number	Box Center Height	Box Qty.
78205152944	BBF15	15" Floorstand	25
78205152945	BBF18	18" Floorstand	25
78205152946	BBF24	24" Floorstand	25
78205152947	BBFC	Containment Clip	25
78205152948	BBF15C	15" Floorstand with Cable Clip	25
78205152949	BBF18C	18" Floorstand with Cable Clip	25
78205152950	BBF24C	24" Floorstand with Cable Clip	25

Patent #5595362

Patent #7956285 B2

Read safety/installation instruction sheets in packages before use. These products are designed for positioning only. No load rating.



Floor Mounted Box Support



- See BBF Series (page 33) for an alternative solution.
- Provides support for electrical box from floor track or concrete forms.
- 18" length with break-away feature for 12" or 16" box mounting.
- Finish: Pre-Galvanized.

UPC/Part Number	Catalog Number	Description	Box Qty.
78101103623	BB-18	Floor Mounted Box Support	50

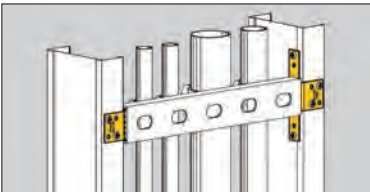

Strut Mounting Brackets



- Attaches 1 $\frac{3}{16}$ " strut, 1 $\frac{1}{2}$ " lathers channel, $\frac{1}{2}$ " EMT or $\frac{3}{4}$ " EMT to metal studs.
- Provides support for vertical runs of conduit.
- Finish: Pre-Galvanized.

UPC/Part Number	Catalog Number	Description	Box Qty.
78101101658	BMB1	Strut Mounting Bracket	25 pr.

Read safety/installation instruction sheets in packages before use. These products are designed for positioning only. No load rating.

Wall studs

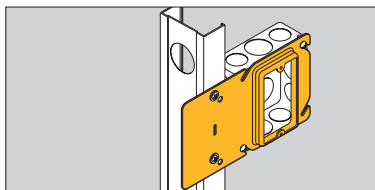

- Uni-Mount™ helps provide a secure support for 4" square boxes and features a built-in plaster ring.
- Rigid bracket design eliminates the need for far-side support.
- Enlarged viewing hole makes it easier to find mark lines on the stud.
- Gangable design accepts BB423 bracket to mount boxes on both sides of the stud.
- Contact factory for pre-fab box assemblies.
- Finish: Pre-Galvanized.

Uni-Mount Box Support/Cover Plate Mounting Bracket

Single Gang
BB40 Series



Double Gang
BB45 Series

UPC/Part Number	Catalog Number	Description	Box Qty.
78205122768	BB40-08	1/2" Raise	50
78205122771	BB40-10	5/8" Raise	50
78205122772	BB40-12	3/4" Raise	50
78205122773	BB45-08	1/2" Raise	50
78205122774	BB45-10	5/8" Raise	50
78205122775	BB45-12	3/4" Raise	50

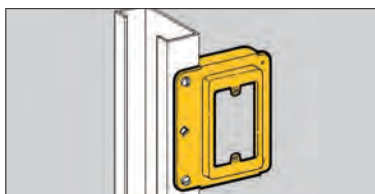

- Provides attachment base for low voltage outlets.
- Replaces electrical box in Class 2 low voltage installations.
- Can be piggy-backed.
- For 1/2" and 5/8" drywall applications.
- Finish: Pre-Galvanized.

Cover Plate Mounting Bracket



UPC/Part Number	Catalog Number	Description	Box Qty.
78101119873	BB15	Single Gang Stud Bracket	50

Read safety/installation instruction sheets in packages before use.
These products are designed for positioning only. No load rating.

Rapid Ring Self Adjusting Pre-Fab Ring

Rapid Ring™ self-adjusting pre-fab plaster ring can help you win tight bids and beat the profit squeeze with its innovative 4-step installation. This revolutionary pre-fab system installs in as little as 15 seconds per unit, compressing your project schedule, helping cut operational costs and helping reduce onsite waste.

Because the Rapid Ring is a self-adjusting pre-fab ring, you'll never need to adjust a mud ring again. With a simple push of the Rapid Ring, you're flush every time.



1. Remove protective plate.
2. Connect the wiring device.
3. Position the device assembly.
4. Push in the device assembly—and you're done!

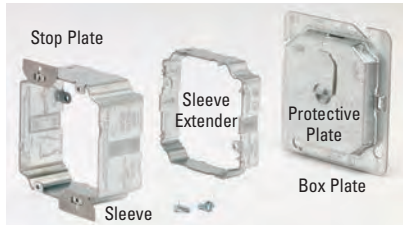

For Use With Wiring Device Qty.	Electrical Box ⁵	Box Plate ¹ Cat. No.	Sleeve ^{2,3} Cat. No.	Sleeve Extender ⁴ Cat. No.
1	4" sq.	B1RRP4C	B1RRR	B1RRE
1	4 ¹ / ₁₆ " sq.	B1RRP5C	B1RRR	B1RRE
2	4" sq.	B2RRP4C	B2RRR	B2RRE
2	4 ¹ / ₁₆ " sq.	B2RRP5C	B2RRR	B2RRE
3	3-gang ⁶	B3RRPC	B3RRR	B3RRE
4	4-gang ⁷	B4RRPC	B4RRR	B4RRE
Double Drywall Cover		B1RRC-1.5	B2RRC-1.5	

1. Protective plate included with box plate.
2. Wall thickness range: ½" min. to 1¼" max.
3. Stop plates included with sleeve.

4. Sleeve extender is an optional accessory to extend max. wall thickness range to 2"
(order separately, mounting hardware included)

5. Minimum electrical box depth is 2½"

6. Keyhole knockouts allow use on 2-gang electrical box.

7. Keyhole knockouts allow use on 3-gang electrical box.

*Covered by and/or for use under one or more of the following U.S. patents:
8,575,484 8,658,894*

Read safety/installation instruction sheets in packages before use. These products are designed for positioning only. No load rating.

Wall studs

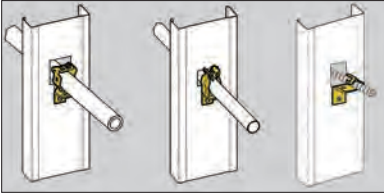

- Supports horizontal runs of conduit, flexible conduit, MC or AC cable through metal studs.
- Attaches easily with a single sheet metal screw.
- Prevents conduit/cable rattling.

Conduit/Cable Supports

Wall Studs



BG-x-H7



BP-x-H7
(Not UL)



BX4-H7



BX4M-H7
(Not UL)

UPC/Part Number	Catalog Number	Conduit/Cable Size	Box Qty.
78101101228	BG-6-H7 *	3/8", MC, AC, or FMC	100
78101110238 Patent #4958792	BG-8-12-H7	1/2" or 3/4"	100
78101101227	BP-8-H7	1/2" EMT	100
78101101226	BP-12-H7	3/4" EMT 1/2" IMC, Rigid	100
78101101200	BX4-H7	MC, AC, or FMC	100
78101101205	BX4M-H7	MC, AC, or FMC	100

* BG-6 will accept the following range Ø.420 - Ø.675:
14/2 thru 10/4 MC/AC cable and 5/16" or 3/8" flexible conduit

Read safety/installation instruction sheets in packages before use.
These products are designed for positioning only. No load rating.

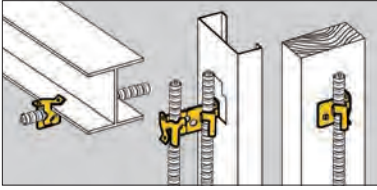

Flexible Conduit/ Cable Fasteners



BX4



BX4M



BX4MD

- Attaches MC, AC, sizes 14/2 through 10/3 or 3/8" FMC to studs or flanges up to 3/16" thick.
- Snaps into place on metal stud openings or may be screwed to metal or wood studs.
- BX4M may be snapped in half to make two BX4's.
- Allows cables to be positioned a minimum of 1 1/4" from face of stud as required by NEC Article 300.4(D).

UPC/Part Number	Catalog Number	Description	Box Qty.
78101101079	BX4	Single Runs	100
78101101080	BX4M	Double Runs	100
78101101224	BX4MD	Up to 4 Runs	100

Read safety/installation instruction sheets in packages before use. These products are designed for positioning only. No load rating.

Wall studs

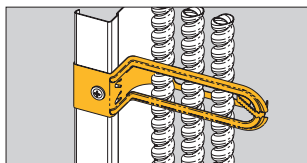

Cable Support

- Unique one-piece design ensures cables are positioned 1¼" from the face of the stud.
- Push mounted for stud positioning.
- Securely attaches to stud using only 1 screw (50% less than other designs).
- Push mount design prevents part from twisting while installing screw.
- Supports more runs of MC cable than competition (up to 6 runs).
- Rigid product with stiffening ribs and more material than competitive offerings.
- Zip tie locking tab allows trouble-free securing of cables.
- Use BRC6M-1 for wider stud applications and for wood studs.

UPC/Part Number	Catalog Number	Stud Size	Box Qty.
79903843761	BRC6M	1¼"	50
79903843762	BRC6M-1	All	50

Note: Canadian applications are limited to wood studs only. See cable capacity in bottom chart.



BRCJ



- Ensures cables are positioned 1¼" from the face of the stud.

UPC/Part Number	Catalog Number	Stud Size	Box Qty.
79903862843	BRCJ	All	100

Cable Type	Cable Size	Cable Capacity	
		BRC6M	BRCJ
Non-Metallic (NM)	14/2, 14/3, 12/2, 12/3, 10/2, 10/3, 8/2 w/grnd.	8	6
	8/3, 6/2 w/grnd.	6	4
Metal Clad (MC)	14/2, 14/3, 14/4, 12/2, 12/3, 12/4, 10/2 w/grnd.	6	4
	10/3, 10/4 w/grnd.	5	4
Armored (AC)	14/2, 14/3, 14/4, 12/2, 12/3, 12/4, 10/2 w/grnd.	6	4
	10/3, 10/4 w/grnd.	5	4
Flexible	5/16"	6	4
Conduit (BX)	3/8"	5	4

The quantity of cables shown in the chart is the maximum. Fewer cables can be supported. Diameters are based on data from a leading cable manufacturer (may vary slightly). Diameters of some NM cables refer to the widest dimension of a flat cable. NA = Not applicable

Read safety/installation instruction sheets in packages before use. These products are designed for positioning only. No load rating.

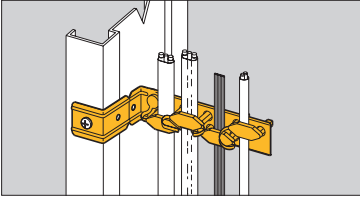

Staple-Lok Multi-Purpose Cable Support



- Individual plastic staples grip cable and reduce slipping.
- Secures up through #10 type NM cable.
- Supports AC, MC or FMC cable up to 1/2" O.D.
- Staple-Lok™ break-apart feature allows installation on studs and furring strips.
- Allows cables to be positioned a minimum of 1 1/4" from face of stud as required by NEC Article 300.4(D).

UPC/Part Number	Catalog Number	Cable Size	Box Qty.
78101103587	BRC4	Up to .500" O.D.	100

Patent #5587555

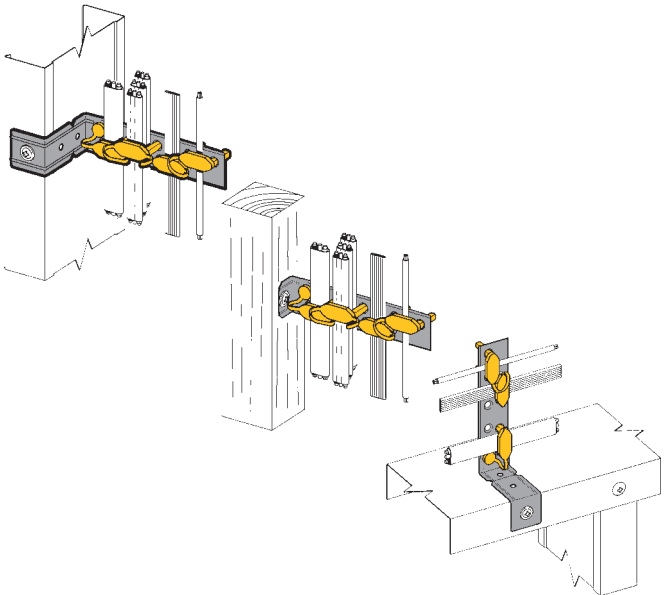

*Read safety/installation instruction sheets in packages before use.
These products are designed for positioning only. No load rating.*

Wall studs

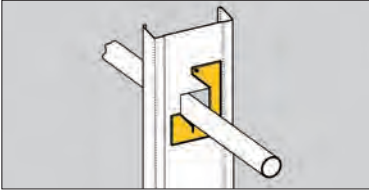

- Allows conduit, MC, AC, or FMC to be pulled through metal studs.
- Provides support for horizontal runs of conduit or cable through metal stud.
- Prevents rattling of conduit/cable.
- Finish: Pre-Galvanized.

Conduit/Cable Supports



UPC/Part Number	Catalog Number	Conduit/Cable Size	Box Qty.
78101101657	BX82	Up to 1"	100

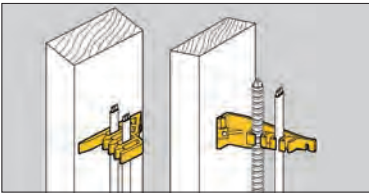

- Attaches Type NM cables to wood studs.
- Can be used to support computer, CATV, telephone, security and instrumentation cables.
- Provided with nail inserted.
- Allows cables to be positioned a minimum of 1 1/4" from face of stud as required by NEC Article 300.4(D).

Cable Fasteners



BRC1



BRC2

UPC/Part Number	Catalog Number	Description	Box Qty.
78101102941	BRC1	Wood Stud Cable Fastener	50
78101102941	BRC2	Furring Strip Cable Fastener	50

Read safety/installation instruction sheets in packages before use. These products are designed for positioning only. No load rating.

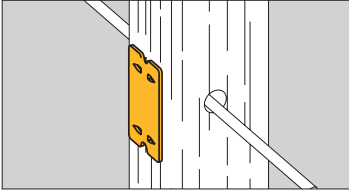

- Protects cable, plastic pipe and copper tubing from screw or nail penetration.
- Easily installed with a hammer.
- Complies with NEC Article 300-4.

Nail Plates For Wood Studs



UPC/Part Number	Catalog Number	Description	Box Qty.
78101104927	BM3	Nail Plate	100

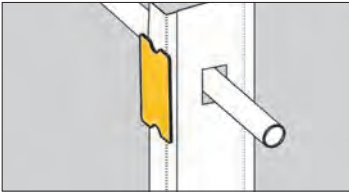

- Protects cable, plastic pipe and copper tubing from screw or nail penetration.
- Comes with industrial grade double stick tape on back for easy installation on stud.
- Complies with NEC Article 300-4.

Nail Plates For Metal Studs

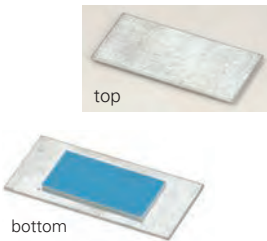

Just Peel Tape and Stick To Stud

UPC/Part Number	Catalog Number	Description	Box Qty.
78101126251	BM3M	Nail Plate	100

Read safety/installation instruction sheets in packages before use. These products are designed for positioning only. No load rating.

Wall studs

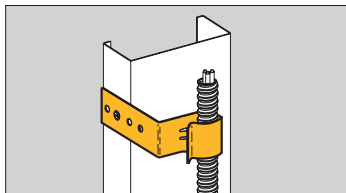

Conduit Support



- Larger capacity: Redesigned BB38D attaches 1/2" to 1" EMT or flexible conduit to metal or wood studs.
- BB38 attaches MC/AC cable, 1/2" & 3/4" EMT to metal or wood studs.
- Eliminates the need for offset bending of conduit.
- Aligns conduit with standard box knockouts.

UPC/Part Number	Catalog Number	Box Depth	Box Qty.
78101104265	BB38	1 1/2"	100
78101195244	BB38D	2 1/8"	100

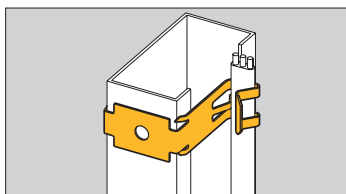

Flexible Conduit/ Cable Fasteners



- Secures Romex® sizes 14/2 w/ground thru 12/3 w/ground, MC/AC sizes 14/2 thru 12/3 to metal or wood studs.
- Allows cables to be positioned a minimum of 1 1/4" from face of stud as required by NEC Article 300.4(D).

UPC/Part Number	Catalog Number	Description	Box Qty.
78101119755	BX5	Secures Flexible Conduit or Cable to Metal or Wood Studs	100

† All other trademarks are property of their respective owners.

Read safety/installation instruction sheets in packages before use. These products are designed for positioning only. No load rating.

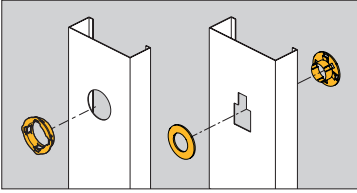

Metal Stud Grommet



- BM1 snaps into standard 1¹¹/₃₂" diameter holes in metal studs from 25 Ga. to 16 Ga.
- BM2 is shipped as one piece and easily separated for installation.
- Universal BM2 provides 360° protection. Fits all factory punched metal stud holes.
- Protects wire insulation in accordance with NEC Article 300.4(B) (1).



BM1



BM2

UPC/Part Number	Catalog Number	Description	Box Qty.
78101119100	BM1	Plastic Grommet	100
78101119102	BM1M	Plastic Grommet (Bulk Quantity)	100
78101104926	BM2	Universal Plastic Grommet	100

Read safety/installation instruction sheets in packages before use. These products are designed for positioning only. No load rating.