

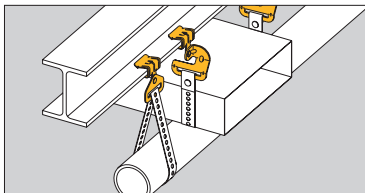

Hangers



- Suspends straps thru 1½" wide from beam flanges ⅛" to ¾" thick.
- Suspends straps parallel or at right angles to beams.
- Simply installed with a hammer.
- Static Load Capacity: 200 Lbs.

Strap Hangers



Parallel

Right Angle

UPC/Part Number	Catalog Number	Description	Flange Thickness	Box Qty.
78101104930	BHE-1-2	Parallel	⅛" to ⅜"	100
78101118870	BH-2-4	Parallel	⅛" to ¼"	100
78101118880	BH-5-8	Parallel	⅝" to ½"	100
78101118890	BH-9-12	Parallel	⅞" to ¾"	100
78101104115	BH-1-2-R	Right Angle	⅛" to ⅜"	100
78101118875	BH-2-4-R	Right Angle	⅛" to ¼"	100
78101118885	BH-5-8-R	Right Angle	⅝" to ½"	100
78101118895	BH-9-12-R	Right Angle	⅞" to ¾"	100

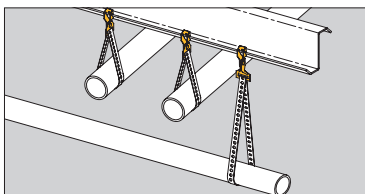

"Z" Purlin Hangers

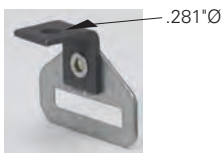

BH-H7



BH-F12

BH-F12-R

UPC/Part Number	Catalog Number	Description	Box Qty.
78101103385	BH-F12	Right Angle	100
78101103384	BH-F12-R	Parallel	100
78101119922	BH-H7	Parallel	100

Read safety/installation instruction sheets in packages before use.

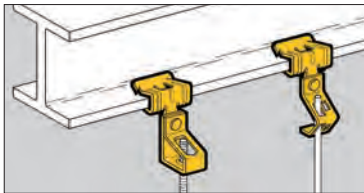

- Suspend wire or plain and threaded rod from beam flanges $\frac{1}{8}$ " to $\frac{3}{4}$ " thick.
- Simply installed with a hammer.
- Static Load Capacity: 160 Lbs.

Rod To Beam Hangers



UPC/Part Number	Catalog Number	Flange Thickness	Description	Box Qty.
78101118900	BH1-E-2-4	$\frac{1}{8}$ " to $\frac{1}{4}$ "	#8 Wire or $\frac{1}{4}$ " Plain Rod	100
78101118905	BH1-E-5-8	$\frac{5}{16}$ " - $\frac{1}{2}$ "	#8 Wire or $\frac{1}{4}$ " Plain Rod	100
78101118910	BH1-E-9-12	$\frac{9}{16}$ " - $\frac{3}{4}$ "	#8 Wire or $\frac{1}{4}$ " Plain Rod	100

UPC/Part Number	Catalog Number	Flange Thickness	Plain Rod Size	Box Qty.
78101118940	BH2-E-2-4	$\frac{1}{8}$ " to $\frac{1}{4}$ "	$\frac{3}{8}$ "	100
78101118945	BH2-E-5-8	$\frac{5}{16}$ " - $\frac{1}{2}$ "	$\frac{3}{8}$ "	100
78101118950	BH2-E-9-12	$\frac{9}{16}$ " - $\frac{3}{4}$ "	$\frac{3}{8}$ "	100

Read safety/installation instruction sheets in packages before use.

Hangers

Rod To Beam Hangers



With thread impression

UPC/Part Number	Catalog Number	Flange Thickness	Threaded Rod Size	Box Qty.
78101118980	BH4-E-2-4	1/8" to 1/4"	1/4"	100
78101118985	BH4-E-5-8	5/16" - 1/2"	1/4"	100
78101118990	BH4-E-9-12	9/16" - 3/4"	1/4"	100
78101119060	BH6-E-2-4	1/8" to 1/4"	3/8"	100
78101119065	BH6-E-5-8	5/16" - 1/2"	3/8"	100
78101119070	BH6-E-9-12	9/16" - 3/4"	3/8"	100

Note: BH4 and BH6 have thread impressions.

UPC/Part Number	Catalog Number	Flange Thickness	Threaded Rod Size	Box Qty.
78101119020	BH5-E-2-4 *	1/8" to 1/4"	1/4" to 3/8"	100
78101119025	BH5-E-5-8 *	5/16" - 1/2"	1/4" to 3/8"	100
78101119030	BH5-E-9-12 *	9/16" - 3/4"	1/4" to 3/8"	100

*Nuts required.



- Compensates for angle of purlin lip.
- Allows for parallel conduit runs or vertical support drops.
- Riveted fasteners will rotate 360°.
- Maximum Purlin thickness of 3/32".

"Z" Purlin Hangers



BF13



BF12

UPC/Part Number	Catalog Number	Description	Static Load Cap. Lbs.	Box Qty.
78101118345	BF13	With 1/4" Hole	100	100
78101118340	BF12	For "S" Hooks	100	100



Guide-Rite™
Fastener
BG Series



Push-Type
BP Series

UPC/Part Number	Catalog Number	Conduit Size EMT & Rigid	Static Load Cap. Lbs.	Box Qty.
78101118445	BG-6-F13 *	3/8"	100	100
78101118520	BG-8-12-F13	1/2", 3/4"	100	100
78101118590	BG-16-F13	1"	100	100
78101118675	BG-20-F13	1 1/4"	100	100
78101119290	BP-8-F13	1/2" EMT	25	100
78101119390	BP-12-F13	3/4" EMT 1/2" IMC, Rigid	25	100
78101119480	BP-16-F13	1" EMT 3/4" IMC, Rigid	25	50

* BG-6 will accept the following range $\varnothing.420 - \varnothing.675$:
14/2 thru 10/4 MC/AC cable and 5/16" or 3/8" flexible conduit

Read safety/installation instruction sheets in packages before use.

Hangers

Universal Beam Fasteners



UPC/Part Number	Catalog Number	Description	Static Load Cap.	Box Qty.
78101118920	BH1-F12	#8 Wire or 1/4" Plain Rod	100 Lbs.	100
78101118960	BH2-F12	3/8" Plain Rod	100 Lbs.	100



UPC/Part Number	Catalog Number	Threaded Rod Size	Static Load Cap.	Box Qty.
78101119000	BH4-F12	1/4"	100 Lbs.	100
78101119080	BH6-F12	3/8"	100 Lbs.	100
78101119040	BH5-F12 *	1/4" & 3/8"	100 Lbs.	100

*Nuts required.

Note: BH4 and BH6 have thread impressions.

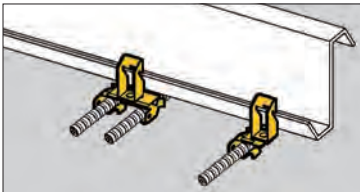

- Compensates for angle of purlin lip.
- Attaches MC, AC, sizes 14/2 through 10/3 or 3/8" FMC to "Z" Purlins up to 3/32" thick.
- Fastener will rotate 360°.
- Simply installed with a hammer.

Cable To "Z" Purlin Flange Hangers



BX4-F13



BX4M-F13

UPC/Part Number	Catalog Number	Description	Flange Thickness	Box Qty.
78101101188	BX4-F13	Single Runs	Thru 3/32"	100
78101101204	BX4M-F13	Double Runs	Thru 3/32"	100

Read safety/installation instruction sheets in packages before use.

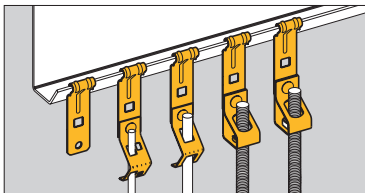

"Z" Purlin Flange Hangers

- Suspend wire, or plain and threaded rod from "Z" Purlins.
- Fits "Z" Purlins 1/16" to 1/4" thick.
- Simply installed with a hammer.
- Static Load Capacity: 160 Lbs.



UPC/Part Number	Catalog Number	Description	Box Qty.
78101104271	BF4	For "S" Hooks, Bolting Straps and Wrap Wire	100

Read safety/installation instruction sheets in packages before use.

Hangers

"Z" Purlin Flange Hangers



UPC/Part Number	Catalog Number	Description	Box Qty.
78101104274	BH1-F4	#8 Wire or 1/4" Plain Rod	100
78101104276	BH2-F4	3/8" Plain Rod	100



UPC/Part Number	Catalog Number	Threaded Rod Size	Box Qty.
78101104286	BH4-F4	1/4"	100
78101104280	BH6-F4	3/8"	100
78101104278	BH5-F4 *	1/4" - 3/8"	100

* Nuts required.

Note: BH4 & BH6 have thread impressions.

Read safety/installation instruction sheets in packages before use.

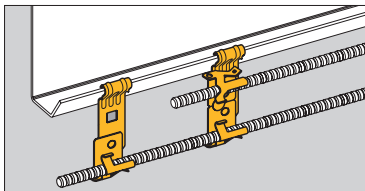

- Attaches MC, AC, sizes 14/2 thru 10/3 or 3/8" FMC to "Z" Purlins.
- Fits "Z" Purlin flanges 1/16" to 1/4" thick.
- Fastener will rotate 360°.

Cable To "Z" Purlin Flange Hangers



UPC/Part Number	Catalog Number	Description	Box Qty.
78101104931	BX4-F4	Single Runs	100

These products are designed for positioning only. No load rating.



UPC/Part Number	Catalog Number	Description	Box Qty.
78101104932	BX4M-F4	Double Runs	100

These products are designed for positioning only. No load rating.

Read safety/installation instruction sheets in packages before use.

Hangers

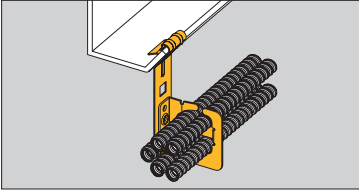

MC/AC Cable Carrier to 'Z' Purlin Flange Hanger

- Secures and supports multiple runs of MC/AC cable to 'Z' purlins.
- Effectively organizes cables and eliminates derating issues.
- Retention tab is open for easy loading and unloading and contains cables when bent in place.
- Load Capacity: 50 lbs.



UPC/Part Number	Catalog Number	Cable Diameter & Number of Runs	Box Qty.
78205144084	BRC51-F4	.430" to .560" Up to 4 Runs	25
78205144085	BRC52-F4	.430" to .560" Up to 9 Runs	25
78205144086	BRC53-F4	.560" to .690" Up to 7 Runs	25

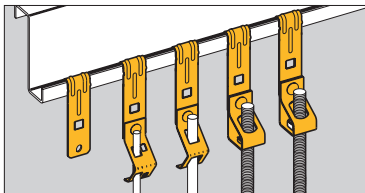

- Suspend wire, or plain and threaded rod from vertical flanges.
- Fits vertical flanges 1/16" to 1/4" thick.
- Static Load Capacity: 160 Lbs.

Vertical Flange Hangers



UPC/Part Number	Catalog Number	Description	Box Qty.
78101104270	BF3	For "S" Hooks, Bolting Straps and Wrap Wire	100

Read safety/installation instruction sheets in packages before use.

Hangers

Vertical Flange Hangers



UPC/Part Number	Catalog Number	Description	Box Qty.
78101104273	BH1-F3	#8 Wire or 1/4" Plain Rod	100
78101104275	BH2-F3	3/8" Plain Rod	100



4 1/4"
Overall Height

UPC/Part Number	Catalog Number	Threaded Rod Size	Box Qty.
78101104285	BH4-F3	1/4"	100
78101104279	BH6-F3	3/8"	100
78101104933	BH5-F3 *	1/4", 3/8"	100

* Nuts required.

Read safety/installation instruction sheets in packages before use.
These products are designed for positioning only. No load rating.

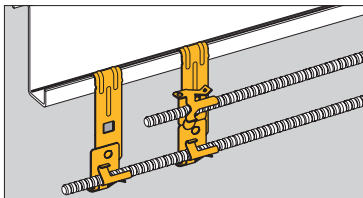

- Attaches MC, AC, sizes 14/2 through 10/3 or 3/8" flexible conduit FMC to vertical flanges 1/16" to 1/4" thick.
- Fastener will rotate 360°.
- Simply installed with a hammer.

Cable To Vertical Flange Hangers



UPC/Part Number	Catalog Number	Description	Box Qty.
78101104281	BX4-F3	Single Runs	100



UPC/Part Number	Catalog Number	Description	Box Qty.
78101104282	BX4M-F3	Double Runs	100

Read safety/installation instruction sheets in packages before use. These products are designed for positioning only. No load rating.

Hangers

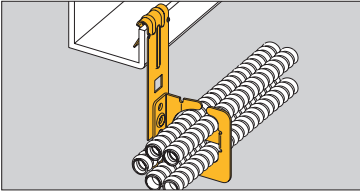

MC/AC Cable Carrier To Vertical Flange Hanger

- Secures and supports multiple runs of MC/AC cable to vertical flanges.
- Effectively organizes cables and eliminates derating issues.
- Retention tab is open for easy loading and unloading and contains cables when bent in place.
- Load Capacity: 50 lbs.



UPC/Part Number	Catalog Number	Cable Diameter & Number of Runs	Box Qty.
78205144081	BRC51-F3	.430" to .560" Up to 4 Runs	25
78205144084	BRC52-F3	.430" to .560" Up to 9 Runs	25
78205144083	BRC53-F3	.560" to .690" Up to 7 Runs	25

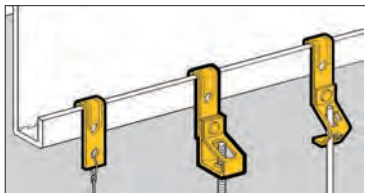

- Suspend wire, or plain or threaded rod from vertical flanges.
- Fits vertical flanges $\frac{1}{16}$ " to $\frac{1}{4}$ " thick.
- Static Load Capacity: 160 Lbs.

Vertical Flange Hangers



UPC/Part Number	Catalog Number	Flange Thickness	Description	Box Qty.
78101118310	BF1	$\frac{1}{16}$ " - $\frac{5}{32}$ "	For "S" Hooks, Bolting Straps and Wrap Wire	100
78101118315	BF2	$\frac{5}{32}$ " - $\frac{1}{4}$ "	For "S" Hooks, Bolting Straps and Wrap Wire	100



UPC/Part Number	Catalog Number	Flange Thickness	Description	Box Qty.
78101118915	BH1-F1	$\frac{1}{16}$ " - $\frac{5}{32}$ "	#8 Wire or $\frac{1}{4}$ " Plain Rod	100
78101118925	BH1-F2	$\frac{5}{32}$ " - $\frac{1}{4}$ "	#8 Wire or $\frac{1}{4}$ " Plain Rod	100

Read safety/installation instruction sheets in packages before use.

Hangers

Vertical Flange Hangers



UPC/Part Number	Catalog Number	Flange Thickness	Plain Rod Size	Box Qty.
78101118955	BH2-F1	1/16" - 5/32"	3/8"	100
78101118965	BH2-F2	5/32" - 1/4"	3/8"	100



UPC/Part Number	Catalog Number	Flange Thickness	Threaded Rod Size	Box Qty.
-----------------	----------------	------------------	-------------------	----------

With Thread Impression

78101118995	BH4-F1	1/16" - 5/32"	1/4"	100
78101119075	BH6-F1	1/16" - 5/32"	3/8"	100
78101119005	BH4-F2	5/32" - 1/4"	1/4"	100
78101119085	BH6-F2	5/32" - 1/4"	3/8"	100

With Clearance Hole

78101118995	BH5-F1 *	1/16" - 5/32"	1/4", 3/8"	100
78101119075	BH5-F2 *	5/32" - 1/4"	1/4", 3/8"	100

* Nuts required.

Read safety/installation instruction sheets in packages before use.

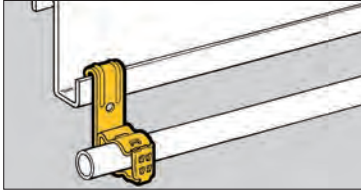

Conduit To Vertical Flange Hangers

- Supports 3/8" to 1" conduit from vertical flanges 1/16" to 1/4" thick.
- Patented Guide-Rite™ feature ensures fastener will close and lock every time.
- Simply installed with a hammer and pliers.
- Static Load Capacity: 25 Lbs.



Guide-Rite™
Fastener



UPC/Part Number	Catalog Number	Conduit Size	Flange Thickness	Box Qty.
78101119957	BG-6-F1 *	3/8"	1/16" - 5/32"	100
78101119960	BG-6-F2 *	3/8"	5/32" - 1/4"	100
78101119958	BG-8-12-F1	1/2" & 3/8"	1/16" - 5/32"	100
78101119961	BG-8-12-F2	1/2" & 3/8"	5/32" - 1/4"	100
78101119958	BG-16-F1	1"	1/16" - 5/32"	100
78101119961	BG-16-F2	1"	5/32" - 1/4"	100

Patent #4958792

* BG-6 will accept the following range Ø.420 - Ø.675:
14/2 thru 10/4 MC/AC cable and 1/16" or 3/8" flexible conduit



UPC/Part Number	Catalog Number	Wire Size	Flange Thickness	Box Qty.
78101103556	BRC3-F1	14/2 & 12/2 With Ground	1/16" - 5/32"	100
78101103557	BRC3-F2	14/2 & 12/2 With Ground	5/32" - 1/4"	100

Note: These products are designed for positioning only. No load rating.

Read safety/installation instruction sheets in packages before use.

Hangers

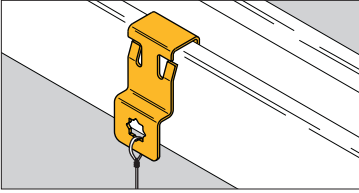

Strut Fasteners



- The BSC4 Series provides a simple, snap-on attachment to strut, eliminating the need for tools and/or drilling during installation.
- Ideal for retrofit and add-on applications.
- BSC4 provides a 1/4" mounting hole along the side of a standard strut member.
- Riveted assemblies allow for easy attachment of conduit, cable and rod.

UPC/Part Number	Catalog Number	Description	Load Capacity	Box Qty.
78205146573	BSC4	Strut Clip	60 lbs.	100



UPC/Part Number	Catalog Number	Rod Size	Load Capacity	Box Qty.
78205146581	BH4-SC4	1/4"-20	60 lbs.	100
78205146582	BH6-SC4	3/8"-16	60 lbs.	100

Read safety/installation instruction sheets in packages before use.



BG_-SC4



BP_-SC4



BL14_-SC4

UPC/Part Number	Catalog Number	Conduit Size	Load Capacity	Box Qty.
78205146577	BG6-SC4	MC/AC & 3/8"	25 lbs.	100
78205146578	BG812-SC4	1/2" & 3/4"	25 lbs.	100
78205146579	BP8-SC4	1/2"	15 lbs.	100
78205146580	BP12-SC4	3/4"	15 lbs.	100
78205146588	BL1400-SC4	1/2"	60 lbs.	100
78205146589	BL1410-SC4	3/4"	60 lbs.	100
78205146590	BL1420-SC4	1"	60 lbs.	100



BX4M_-SC4



BRC5_-SC4

UPC/Part Number	Catalog Number	Cable Size Runs	Load Capacity	Box Qty.
78205146584	BX4M-SC4	14/2 - 10/3 up to 2 runs	–	100
78205146585	BRC51-SC4	.430" to .560" up to 4 runs	50 lbs.	100
78205146586	BRC52-SC4	.430" to .560" up to 9 runs	50 lbs.	100
78205146587	BRC53-SC4	.560" to .690" up to 7 runs	50 lbs.	100

Read safety/installation instruction sheets in packages before use.

Hangers

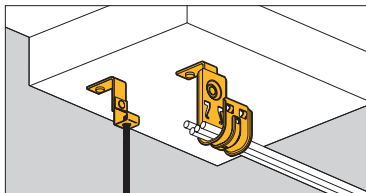

- Special support bracket allows clearance for powder actuated tools.
- Exclusive 1/4" drive pin now pre-installed.
- Pins rated for concrete up to 4000 psi.
- Static Load Capacity: 30 Lbs. unless specified. Limited by fastener assembly. Pin rating must be considered before installation.

Drive Pin Fasteners



BPNA



BCH21-PNA
BCH32-PNA



BH-PNA



BH1-PNA
BH2-PNA

UPC/Part Number	Catalog Number	Description	Box Qty.
78205125583	BPNA	Angle Bracket	100
78205128090	BCH12-PNA	3/4" Cable Hook	100
78205125584	BCH21-PNA	1 5/16" Cable Hook	50
78205125586	BCH32-PNA	2" Cable Hook	50
78205125588	BCH64-PNA	4" Cable Hook	25
78205125611	BH-PNA	Strap Hanger	100
78205125593	BH1-PNA	#8 Wire or 1/4" Plain Rod	100
78205125596	BH2-PNA	3/8" Plain Rod	100

Read safety/installation instruction sheets in packages before use.

Drive Pin Fasteners



BH_PNA



BG_PNA



BP_PNA



BL14_PNA



BX4_PNA



BX4M_PNA

UPC/Part Number	Catalog Number	Description	Box Qty.
78205125604	BH4-PNA *	1/4" Threaded Rod	100
78205125606	BH6-PNA *	3/8" Threaded Rod Cable Hook	100
78205125605	BH5-PNA **	1/4" or 3/8" Threaded Rod	100
78205125613	BG6-PNA ***	3/8" Conduit	100
78205125615	BG8-12-PNA	1/2" & 3/4" Conduit	100
78205125616	BG16-PNA	1" Conduit	100
78205125623	BP8-PNA	1/2" EMT	100
78205125624	BP12-PNA	3/4" EMT	100
78205125630	BP16-PNA	1" EMT	100
78205125620	BL1400-PNA	1/2" Conduit	100
78205125621	BL1410-PNA	3/4" Conduit	100
78205125622	BL1420-PNA	1" Conduit	100
78205125590	BX4-PNA	Single Run MC, AC or FMC	100
78205125591	BX4M-PNA	Double Run MC, AC or FMC	100

* With threaded impressions. ** Nuts required.

*** BG-6 will accept the following range $\varnothing.420 - \varnothing.675$:

14/2 thru 10/4 MC/AC cable and 5/16" or 3/8" flexible conduit

Read safety/installation instruction sheets in packages before use.

Deck Hanger Bracket



BDH Series and Riveted Assemblies

- Supports conduit or pipe up to 1½" diameter
- Provides minimum conduit standoff of 1½" to meet the NEC® section 300.4(E)†
- Attach BDH1 thru BDH3 to deck or other structure using ¼" or ⅜" diameter fasteners to hang ¼" or ⅜" ATR (see table for hole sizes of their respective parts)
- For single conduit runs up to 1½" diameter, deck hanger is paired with conduit hanger and Guide-Rite™ fastener
- S18 assembly includes Guide Rite conduit and electrical box support hanger, which helps ensure proper support of boxes and conduit per NEC

NOTE: Use appropriate installation hardware (not included) for the specific product application, mounting surface and loads.

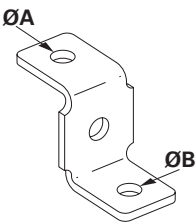

Fig. 1

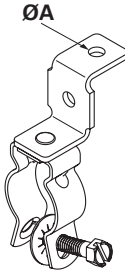

Fig. 2

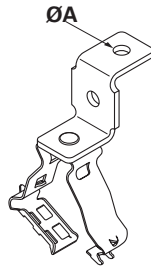
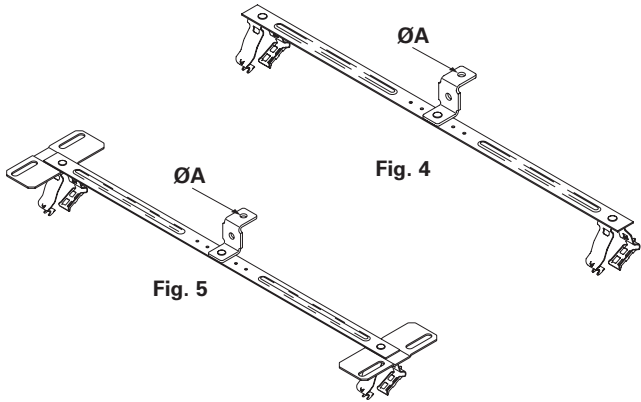

Fig. 3

Material/Finish:

BDH series hangers, BL1400 series conduit hangers & S18 bar are galvanized steel
BG series conduit clips are spring steel/zinc phosphate

All other trademarks are property of their respective owners.

Deck Hanger Bracket *cont'd.*

Catalog No.	Fig No.	Hole Ø		Conduit Ø	Static Load* lbs(kg)	Box Qty
		A	B			
BDH1	1	1/4"	1/4"	—	230 (104)	100
BDH2	1	1/4"	3/8"	—	230 (104)	100
BDH3	1	3/8"	3/8"	—	250 (113)	100
BL1400-DH	2	1/4"	—	1/2" EMT/RGD	100 (45)	50
BL1410-DH	2	1/4"	—	3/4" EMT/RGD	100 (45)	50
BL1420-DH	2	1/4"	—	1" EMT/RGD	100 (45)	50
BL1425-DH	2	1/4"	—	1 1/4" EMT	100 (45)	50
BL1430-DH	2	1/4"	—	1 1/2" EMT, 1 1/4" RGD	100 (45)	50
BG6-DH	3	1/4"	—	3/8" EMT/RGD**	25 (11)	50
BG812-DH	3	1/4"	—	1/2" - 3/4" EMT/RGD	50 (23)	50
BG16-DH	3	1/4"	—	1" EMT/RGD	60 (27)	50
BG20-DH	3	1/4"	—	1 1/4" EMT/RGD	75 (34)	50
BG24-DH	3	1/4"	—	1 1/2" EMT/RGD	80 (36)	50
BG6-S18-DH	4	1/4"	—	3/8" EMT/RGD**	25 (10)	25
BG812-S18-DH	4	1/4"	—	1/2" - 3/4" EMT/RGD	25 (10)	25
BG16-S18-DH	4	1/4"	—	1" EMT/RGD	25 (10)	25
BG6-S18-DH-MC3	5	1/4"	—	3/8" EMT/RGD**	25 (10)	25
BG812-S18-DH-MC3	5	1/4"	—	1/2" - 3/4" EMT/RGD	25 (10)	25
BG16-S18-DH-MC3	5	1/4"	—	1" EMT/RGD	25 (10)	25

*Static load limits are for deck hanger brackets only; use appropriate mounting hardware.

**Accepts .420 - .675 diameter; 14/2 thru 10/4 MC/AC cable and 5/16" or 3/8" flexible conduit.

† NEC® Section 300.4(E) states that cables and raceways must be installed at least 1 1/2" (38 mm) under the roof decking to prevent potential damage from nails or screws.

Hangers

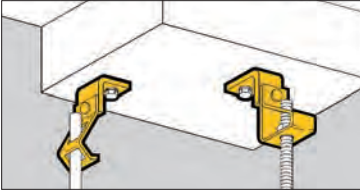

- Suspend plain or threaded rod and drop wire from ceilings, walls, concrete beams, joists and laminated wood beams.
- Clearance hole for 1/4" bolt provided.
- Static Load Capacity: 160 Lbs.

Angle Bracket Fasteners



UPC/Part Number	Catalog Number	Description	Box Qty.
78101118930	BH1-H7	#8 Wire or 1/4" Plain Rod	100
78101118975	BH2-H7	For 3/8" Plain Rod	100



UPC/Part Number	Catalog Number	Threaded Rod Size	Box Qty.
78101119010	BH4-H7	1/4"-20	100
78101119090	BH6-H7	3/8"-16	100
78101119050	BH5-H7 *	1/4"-20 or 3/8"-16	100

* Nuts required.

Note: BH4 & BH6 have thread impressions.

Read safety/installation instruction sheets in packages before use.

Eaton's B-Line series fasteners Eaton.com/b-lineseries

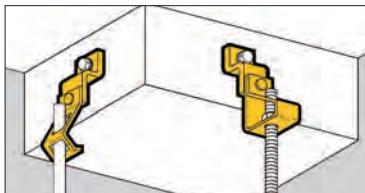

- Suspend plain or threaded rod and drop wire from ceilings, walls, beams, and joists.
- Clearance hole for 1/4" bolt provided.
- Static Load Capacity: 160 Lbs.

Offset Bracket Fasteners



UPC/Part Number	Catalog Number	Description	Box Qty.
78101118935	BH1-H8	#8 Wire or 1/4" Plain Rod	100
78101118975	BH2-H8	3/8" Plain Rod	100



UPC/Part Number	Catalog Number	Threaded Rod Size	Box Qty.
78101119015	BH4-H8	1/4"-20	100
78101119095	BH6-H8	3/8"-16	100
78101119055	BH5-H8 *	1/4"-20 or 3/8"-16	100

* Nuts required.

Note: BH4 & BH6 have thread impressions.

Read safety/installation instruction sheets in packages before use.

Hangers



- Suspend $\frac{3}{8}$ " threaded rod from ceilings, walls, beams, and joists.
- Finish: Zinc Plated.
- Static Load Capacity: 610 Lbs.

Threaded Rod Hangers

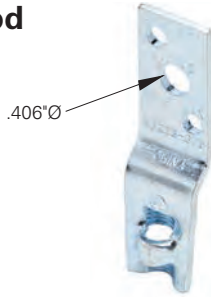

UPC/Part Number	Catalog Number	Description	Box Qty.
78101101661	B3223-$\frac{3}{8}$	Offset Eye Socket	100

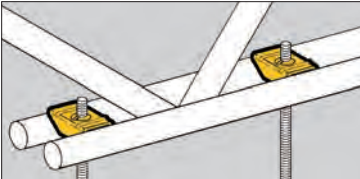

- Allows centering on all open web joists with round bottom chords.
- Static Load Capacity:
BH11 = 200 Lbs.
BH12 = 100 Lbs.

Wedge Hangers

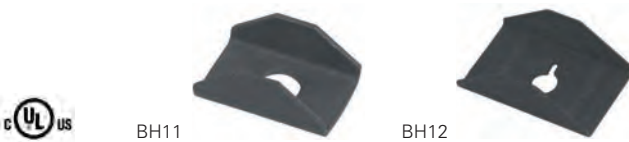

UPC/Part Number	Catalog Number	Description	Box Qty.
78101118860	BH11	With $\frac{3}{8}$ " Clearance Hole	100
78101118865	BH12	With $\frac{1}{4}$ "-20 Thread Impression	100

Read safety/installation instruction sheets in packages before use.

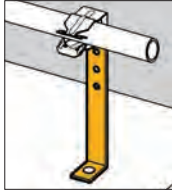
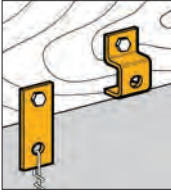

- Brackets are easily attached with screws or drive pins to wood, concrete or steel structures.
- Brackets are adaptable for use with a wide variety of fasteners, wires, "S" hooks and hangers.



BD2



BD4



BA28B

UPC/Part Number	Catalog Number	Description	Box Qty.
78101101686	BD2	Flat Bracket	100
78101118280	BD4	Offset Bracket	100
78101101449	BA28B	Angle Bracket	100

Read safety/installation instruction sheets in packages before use.

Hangers



- BH1, BH2: Supports wire or plain rod.
- BH7, BH8: For wire or chain drop from concrete or wood.
- BH4, BH5, BH6 supports 1/4" or 3/8" threaded rod.
- Static Load Capacity: 160 Lbs.

Components



UPC/Part Number	Catalog Number	Description	Box Qty.
78101118800	BH1	#8 Wire or 1/4" Plain Rod	100
78101118805	BH2	For 3/8" Plain Rod	100

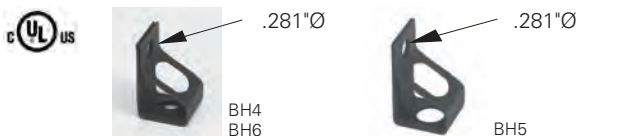

UPC/Part Number	Catalog Number	Description	Box Qty.
78101118815	BH4	For 1/4" Threaded Rod	100
78101118825	BH6	For 3/8" Threaded Rod	100
78101118820	BH5 *	For 1/4" & 3/8" Threaded Rod	100

* Nuts required.
Note: BH4 & BH6 have thread impressions.



UPC/Part Number	Catalog Number	Description	Box Qty.
78101118830	BH7	Angle Bracket With .281"Ø Holes	100
78101118835	BH7-6	Angle Bracket With .281"Ø & .406"Ø Holes	100
78101118840	BH8	Offset Bracket With .281"Ø Holes	100
78101118845	BH8-6	Offset Bracket With .281"Ø & .406"Ø Holes	100

Read safety/installation instruction sheets in packages before use.