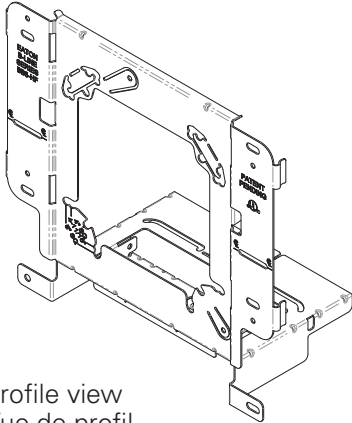


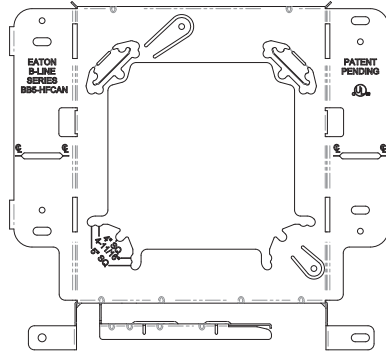
BB5-HF hands-free box bracket

BB5-HF support de boîte mains libres

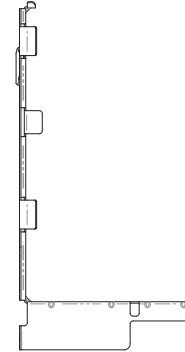
Catalog # No de catalogue	UPC # # UPC	Description Description	Metal Stud Size Taille des poteaux métalliques	Box Qty. Qté par boîte
BB5-HF	13243788	Box support bracket Support de boîte	2½" - 6"	25



Profile view
Vue de profil



Front view
Vue de face



Side view
Vue de côté



Important to note

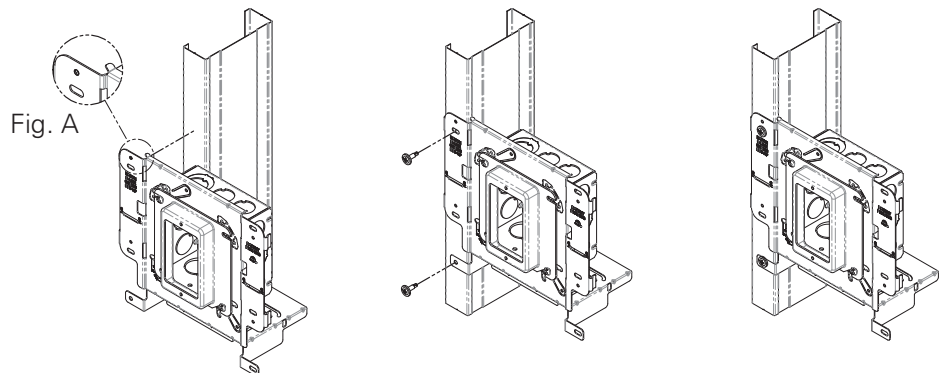
- A simple push and the bracket holds itself onto the stud until secured with screws
- Accepts 4" 4¹¹/₁₆", and 5" boxes
- Built-in adjustable support system provides back support on studs from 2.5" up to 6" depths
- Patent pending

Important

- Une simple pression et le support se fixe sur le poteau avant d'être verrouillé avec une vis
- Accepte les boîtes de 4", 4¹¹/₁₆" et 5"
- Le système de support réglable intégré fournit un support arrière pour poteaux de profondeurs allant de 2,5 " à 6"
- Brevet en attente

Stud attachment

Montage sur poteau



Push bracket onto stud. If too tight or loose, adjust by bending tab shown above (Fig.A).

Poussez le support sur le poteau. S'il est trop serré ou mal ajustée, utilisez la languette de réglage illustrée ci-dessus (Fig.A).

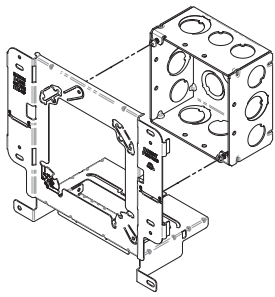
Secure to stud with at least 1 screw.

Fixer au poteau avec au moins 1 vis.

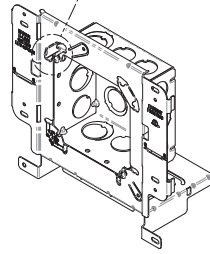
EATON

Powering Business Worldwide

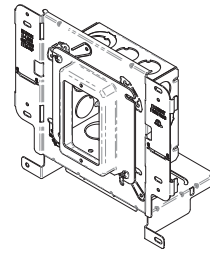
Attaching box and plaster ring
Boîte de fixation et anneau de plâtre



Line up box with bracket mounting holes. Push screws past locking tab.
 Aligner le boîtier avec les trous de fixation du support. Pousser les vis au-delà de la languette de verrouillage.



Push down locking tabs to secure box.
 Abaissez les languettes de verrouillage pour sécuriser la boîte.

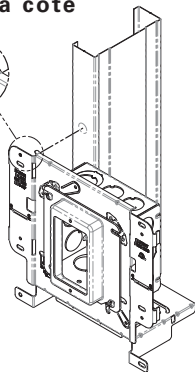


Twist plaster ring into place and tighten box screws.
 Mettez en place l'anneau pour plâtre et serrez les vis du boîtier.

Side by side
Côte à côte

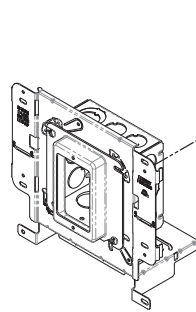


Fig. A



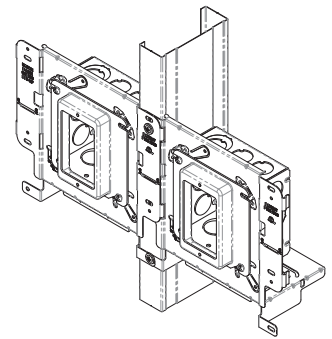
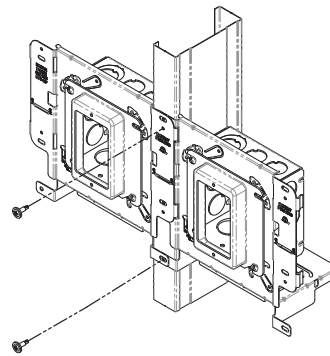
Push bracket onto stud. If too tight or loose, adjust by bending tab shown above (Fig.A).

Poussez le support sur le poteau. S'il est trop serré ou mal ajustée, ajustez-le en pliant la languette illustrée ci-dessus (Fig.A).



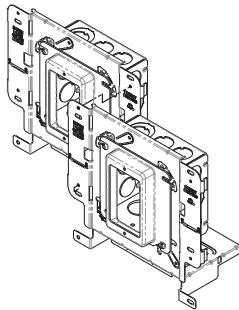
Install second bracket over the first onto the stud by inserting the two tabs into two slots and pushing.

Installez le deuxième support sur le premier et dans le poteau en insérant les deux languettes dans les deux fentes et en poussant.

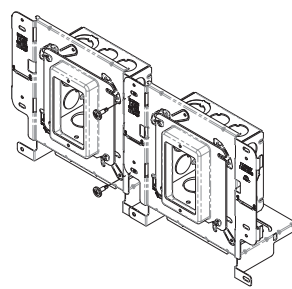


Secure to stud with at least 1 screw.
 Fixer au poteau avec au moins 1 vis.

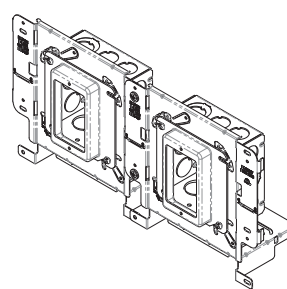
Ganged boxes
Boîtes groupées



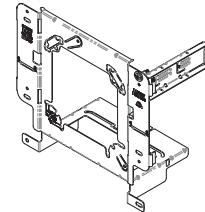
Insert tabs of second bracket into slots of first bracket.
 Insérez les languettes du deuxième support dans les fentes du premier support.



Insert 2 screws.
 Insérez 2 vis.

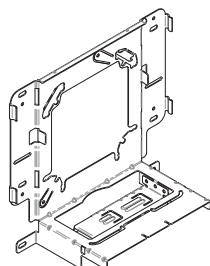


Back support leg can be attached to far corner or ganged box junction for additional stability.

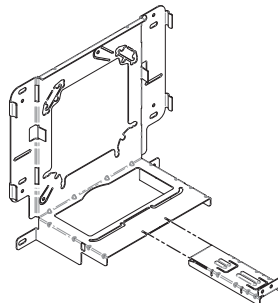


La colonne arrière peut être fixée à un coin éloigné ou à la jonction d'une boîte groupée pour plus de stabilité.

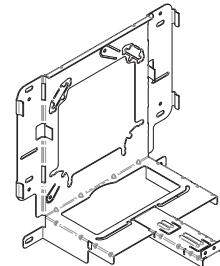
6" Deep stud back support
Support arrière de 6"



Twist and break off leg.
 Tordre et casser l'onglet.

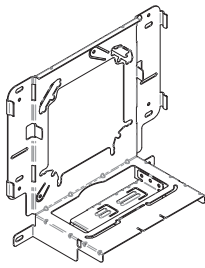


Push leg onto back of bracket.
 Poussez-le à l'arrière du support.



5.5" Deep stud box support

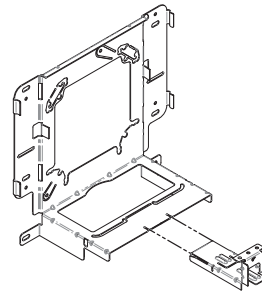
Support de boîte pour poteau de 5,5 po de profondeur



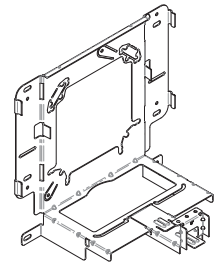
Twist and break off leg.
Tordre et casser l'onglet.



Cut connectors at 5.5" mark.
Couper les connecteurs à la
marque de 5,5 ".



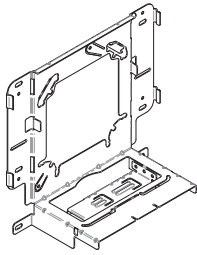
Bend up leg segment.
Pliez le segment de l'onglet.



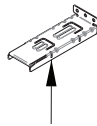
Push leg onto back of bracket.
Pousser l'onglet sur l'arrière
du support.

4" Deep stud box support

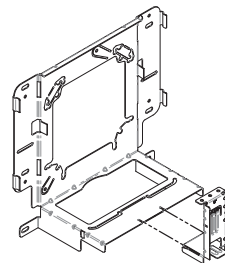
Support de boîte pour poteau de 4" de profondeur



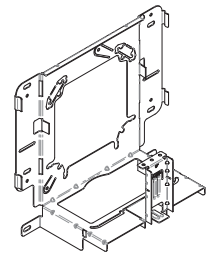
Twist and break off leg.
Tordre et casser l'onglet.



Cut connectors at 4" mark.
Couper les connecteurs à la
marque de 4 ".



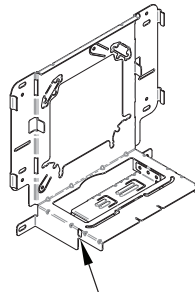
Bend up leg segment.
Pliez le segment de l'onglet.



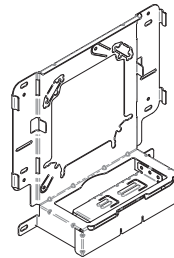
Push leg onto back of bracket.
Pousser l'onglet sur l'arrière
du support.

2.5" Deep stud box support

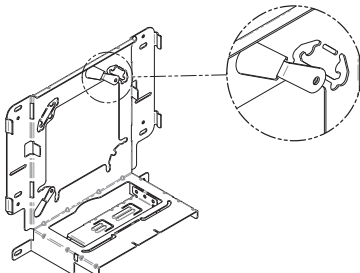
Support de boîte pour poteau de 2.5" de profondeur



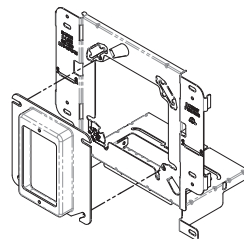
Cut bottom tabs of back support & bend down.
Couper les languettes inférieures du support
arrière et plier les vers le bas.



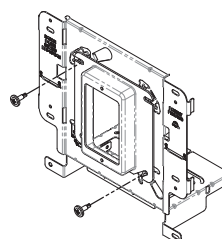
Plaster ring only Anneau de plâtre seulement



Bend top and bottom ears over.
Pliez les oreilles du haut et du bas.



Align plaster ring.
Aligner l'anneau de plâtre.



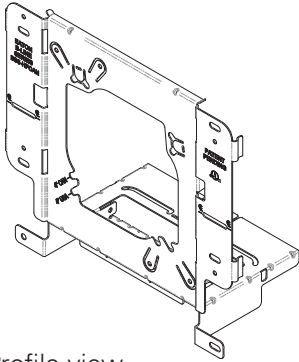
Insert screws.
Insérez les vis.

BB5-HFCAN hands-free box bracket

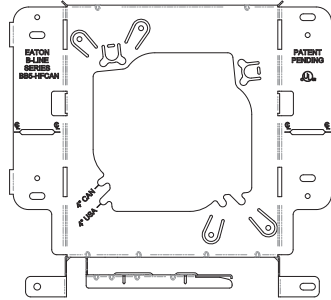
BB5-HFCAN support de boîte mains libres

Catalog # No de catalogue	UPC # # UPC	Description Description	Metal Stud Size Taille des poteaux métalliques	Box Qty. Qté par boîte
BB5-HFCAN	13243789	Box support bracket Support de boîte	2½" - 6"	25

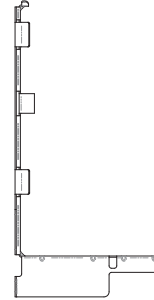
BB5-HFCAN



Profile view
Vue de profil



Front view
Vue de face



Side view
Vue de côté



Important to note

- Fits Iberville† 4-inch square box and U.S. 4" square box

Important

- Convient aux boîtes Iberville † de 4" et aux boîtes US de 4 "

Eaton
1000 Eaton Boulevard
Cleveland, OH 44122
United States
Eaton.com

© 2019 Eaton
All Rights Reserved
Printed in USA
Publication No. IL306193EN-FC
January 2019 FIS-176

B-Line Division
509 West Monroe Street
Highland, IL 62249
United States
Phone: 800-851-7415
Eaton.com/HF-bracket

Eaton is a registered trademark.

†All other trademarks are property of their respective owners.



Follow us on social media to get the latest product and support information.

