

RELEASE STATUS  
Production

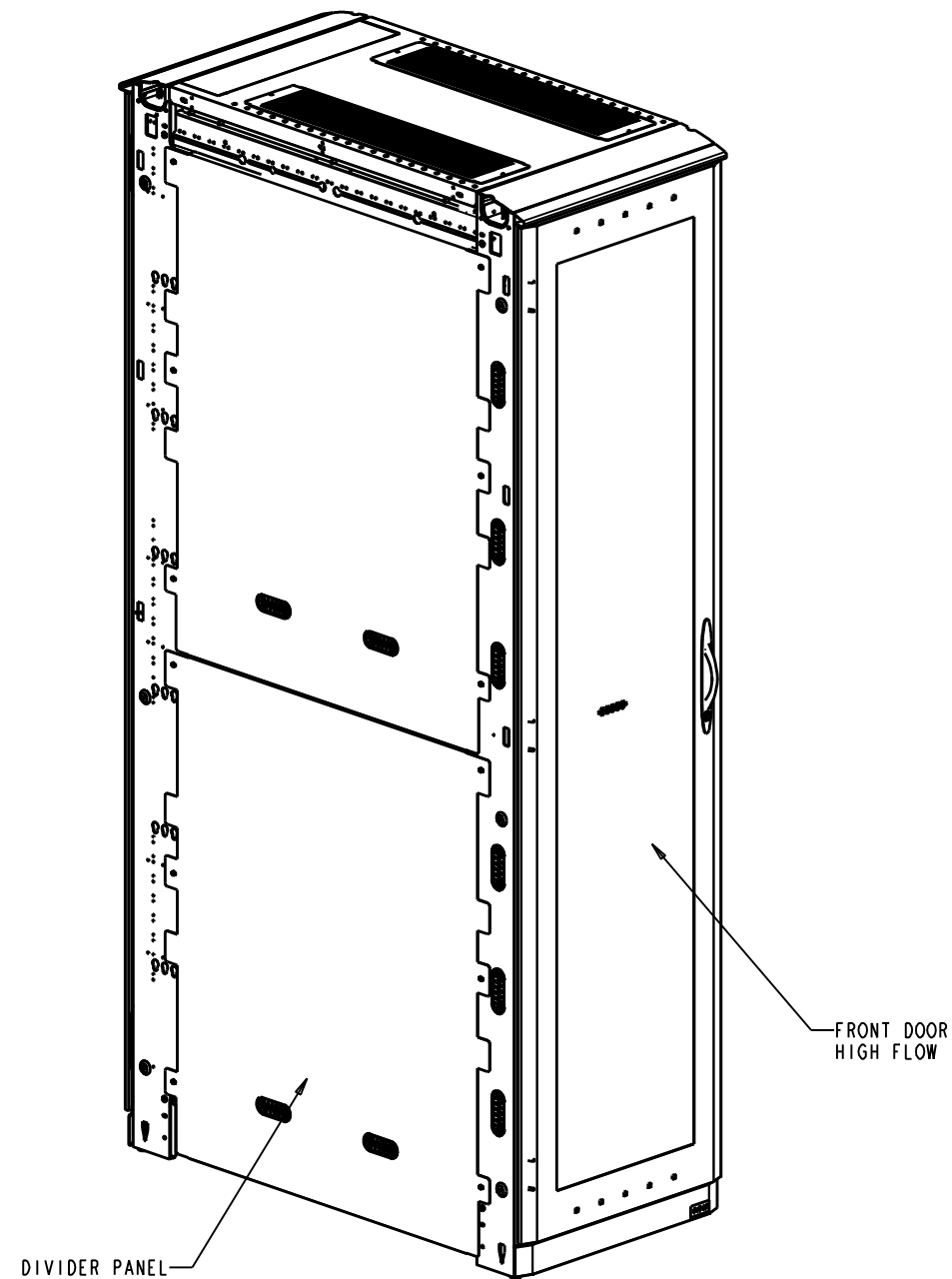

FRONT ISO

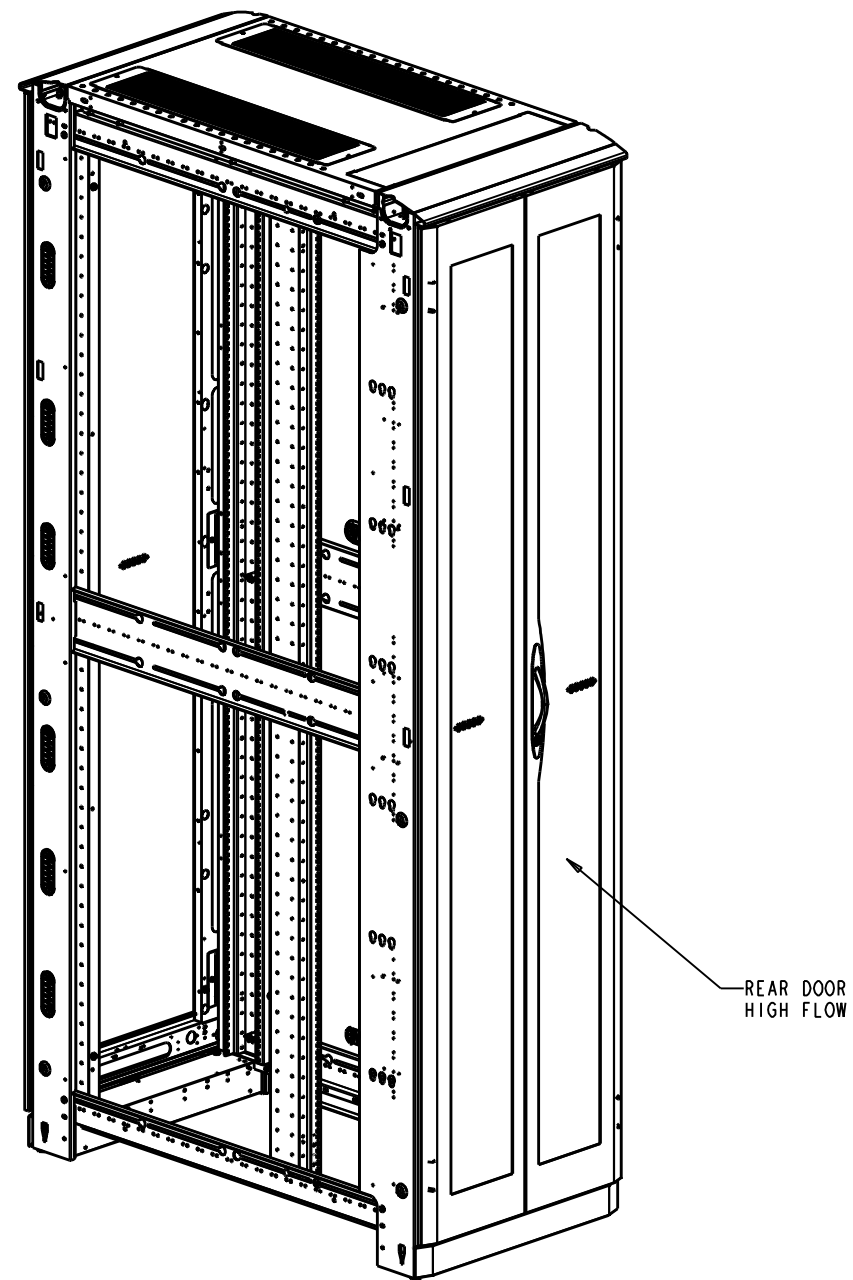

REAR ISO

SHIPPING WEIGHT: 430 LBS

REV	REV. DATE	REV'D BY	CURRENT REVISION DESCRIPTION	ECN OR EPR NUMBER
-	11/28/11	MQuaglia	PRODUCTION RELEASE	EPR113387

THIS DRAWING CONTAINS PROPRIETARY INFORMATION AND IS LOANED SUBJECT TO RETURN UPON DEMAND AND UPON THE EXPRESS CONDITION THAT IT WILL NOT BE USED IN ANY WAY DETRIMENTAL TO THE INTEREST OF EATON CORPORATION

DRAWN IN THIRD ANGLE PROJECTION

TOLERANCE UNLESS SPEC'D  
 .XX ± .02  
 .XXX ± .005  
 < ± .1"

ALL DIMENSIONS IN INCHES

CAGE NUMBER: <b>81824</b>	CUSTOMER: EATON DIR FLD SALES
DES. BY: MQuaglia	11/28/11
DRWN. BY: MQuaglia	11/28/11
DESIGN MGMT SITE: Worcester	PROD. GRP: 50 - Paramount
MATERIAL:	COLOR: -
MATERIAL FINISH:	CRS GA: N/A
SPEC #:	OTHER: -



PMOUNT CONFIG 51U X 24W X 48D  
RACK HYGIENE, 2 EPDU, HCS TOP

SHEET: 1 OF 8	REV DATE: 11/28/11
D	PMT512448HCSTPL
REV	-

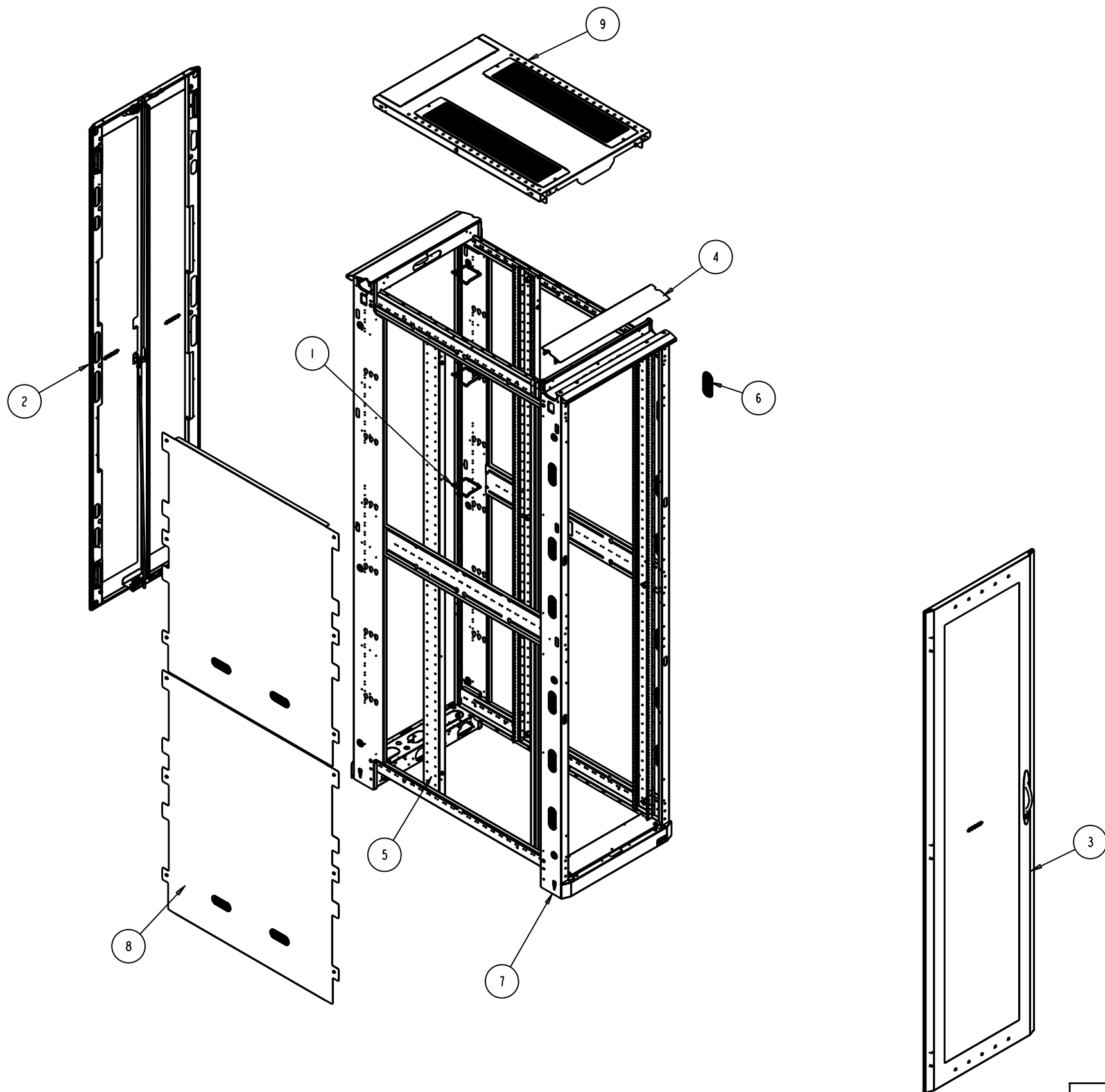

ASSEMBLY WIRING NOTE:

- GROUND ALL DOORS, RAILS, TOP AND DIVIDER PANELS.  
USE GROUNDING LANYARDS FROM KIT P/N GRNDPMT.  
USE STANDARD W/L GROUND POINTS FOR ATTACHMENT AREAS.

ITEM	TYPE	DOCUMENT #	REV	DESCRIPTION	QTY
10	SA	GRNDPMT	-	GROUND KIT - PARAMOUNT	1
9	MA	PMTNWP2448HCS	-	HCS TOP PANEL - 24W X 48D, DBL	1
8	MA	PMTJVD5148S	-	DIVIDER PANEL ASY - 51U X 48D	1
7	MA	PMTFRM512445	-	WLD - FRAME, 51U X 24W X 45D	1
6	MA	JWOVLGROM	A	GROMMET - OVAL 1.5WX4L	12
5	MA	JRM10006	B	RACK MOUNT RAILS - 51U	1
4	MA	JFTK24_4596	B	FRAME TRIM KIT - 24"W	1
3	MA	JDDHF9624L	-	DOOR, HIGH FLOW	1
2	MA	JDDHF9624	-	ASSEMBLY - SPLIT DOOR, HIGH FLOW	1
1	MA	CMDRNR032U_	-	D-RING KIT, 2U	1

THIS DRAWING CONTAINS PROPRIETARY INFORMATION AND IS LOANED SUBJECT TO RETURN UPON DEMAND AND UPON THE EXPRESS CONDITION THAT IT WILL NOT BE USED IN ANY WAY DETRIMENTAL TO THE INTEREST OF EATON CORPORATION

DRAWN IN THIRD ANGLE PROJECTION

TOLERANCE UNLESS SPEC'D  
.XX ± .02  
.XXX ± .005  
∠ ± 1°  
ALL DIMENSIONS IN INCHES

CAGE NUMBER: 81824  
CUSTOMER: EATON DIR FLD SALES  
DES. BY: MQuaglia 11/28/11  
DRWN. BY: MQuaglia 11/28/11  
DESIGN MGMT SITE: Worcester  
PROD. GRP: 50 - Paramount  
COLOR: -  
CRS GA: N/A  
OTHER: -  
MATERIAL:  
MATERIAL FINISH:  
SPEC #:

**EATON**

PMOUNT CONFIG 51U X 24W X 48D  
RACK HYGIENE, 2 EPDU, HCS TOP

SHEET: 2 OF 8  
REV DATE: 11/28/11  
D PMT512448HCSTPL REV -

REV	REV. DATE	REV'D BY	CURRENT REVISION DESCRIPTION	ECN OR EPR NUMBER
-	11/28/11	MQuaglia	PRODUCTION RELEASE	EPRI13387

RELEASE STATUS  
Production

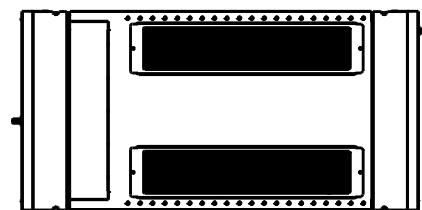

TOP

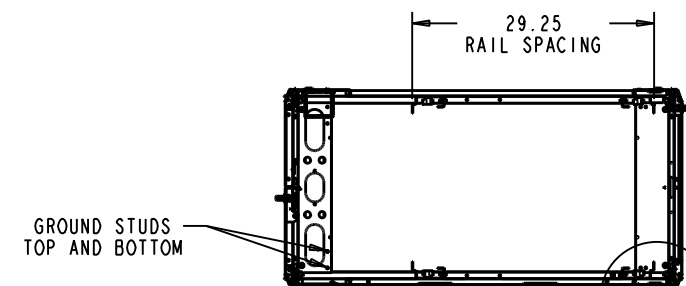

29.25  
RAIL SPACING

GROUND STUDS  
TOP AND BOTTOM

SECTION B-B

DETAIL D  
SCALE 0.200



2.00 FROM FRONT  
OF RAIL TO FRONT  
OF CORNER POST

SEE DETAIL D

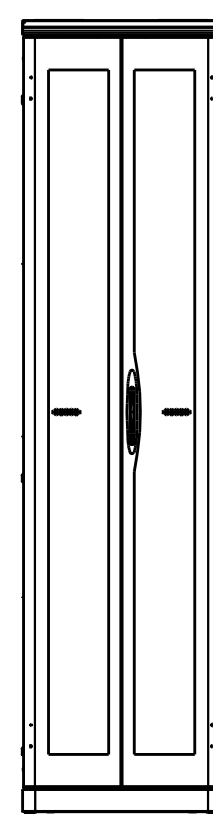

REAR

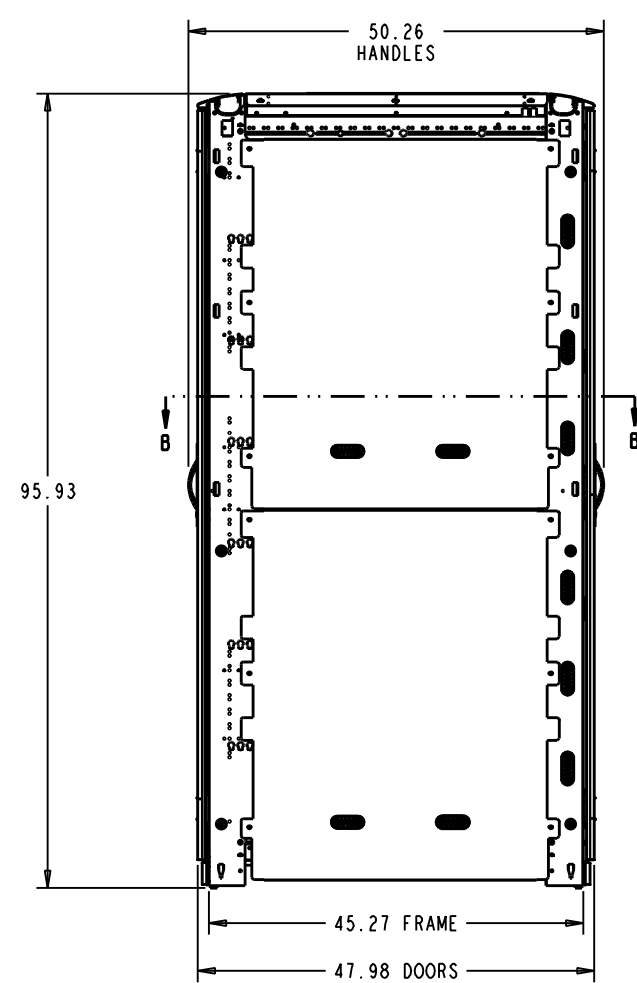

LEFT SIDE

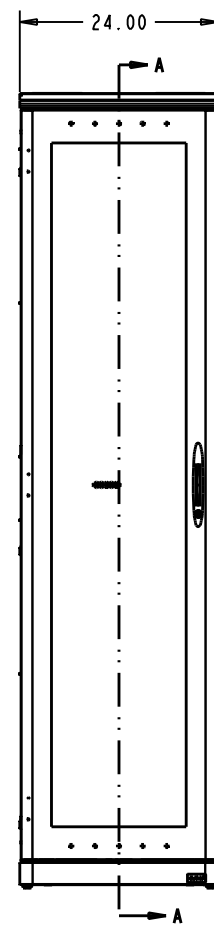

FRONT

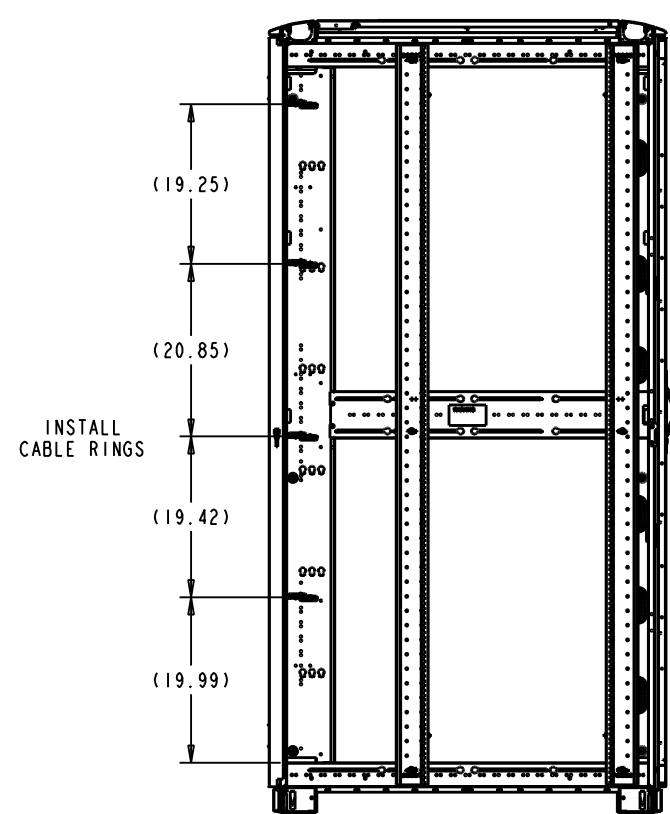

INSTALL  
CABLE RINGS

SECTION A-A

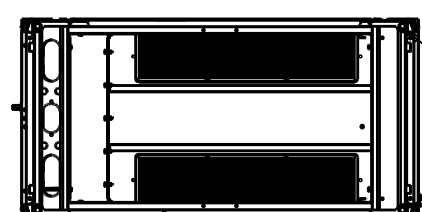
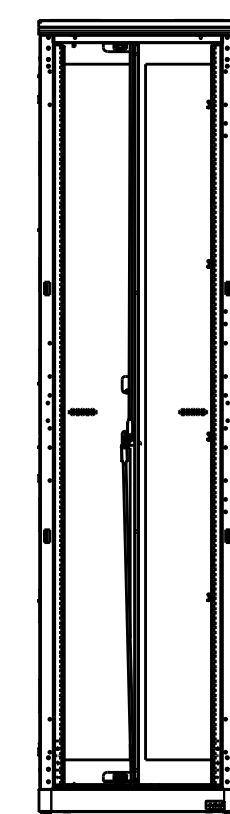

LEVELING FEET

BOTTOM

REV	REV. DATE	REV'D BY	CURRENT REVISION DESCRIPTION	ECN OR EPR NUMBER
-	11/28/11	MQuaglia	PRODUCTION RELEASE	EPR113387

THIS DRAWING CONTAINS PROPRIETARY INFORMATION AND IS LOANED SUBJECT TO RETURN UPON DEMAND AND UPON THE EXPRESS CONDITION THAT IT WILL NOT BE USED IN ANY WAY DETRIMENTAL TO THE INTEREST OF EATON CORPORATION

**DRAWN IN THIRD ANGLE PROJECTION**

TOLERANCE UNLESS SPEC'D  
 .XX ± .02  
 .XXX ± .005  
 < ± .1"

ALL DIMENSIONS IN INCHES

CAGE NUMBER: <b>81824</b>	CUSTOMER: EATON DIR FLD SALES
DESIGN MGMT SITE: Worcester	DES. BY MQuaglia 11/28/11
MATERIAL:	DRWN. BY MQuaglia 11/28/11
MATERIAL FINISH:	PROD. GRP 50 - Paramount
SPEC #:	COLOR: -
	CRS GA: N/A
	OTHER: -

<b>EATON</b>	
PMOUNT CONFIG 51U X 24W X 48D RACK HYGIENE, 2 EPDU, HCS TOP	
SHEET: 3 OF 8	REV DATE: 11/28/11
D	PMT512448HCSTPL REV -