

FRONT ISO

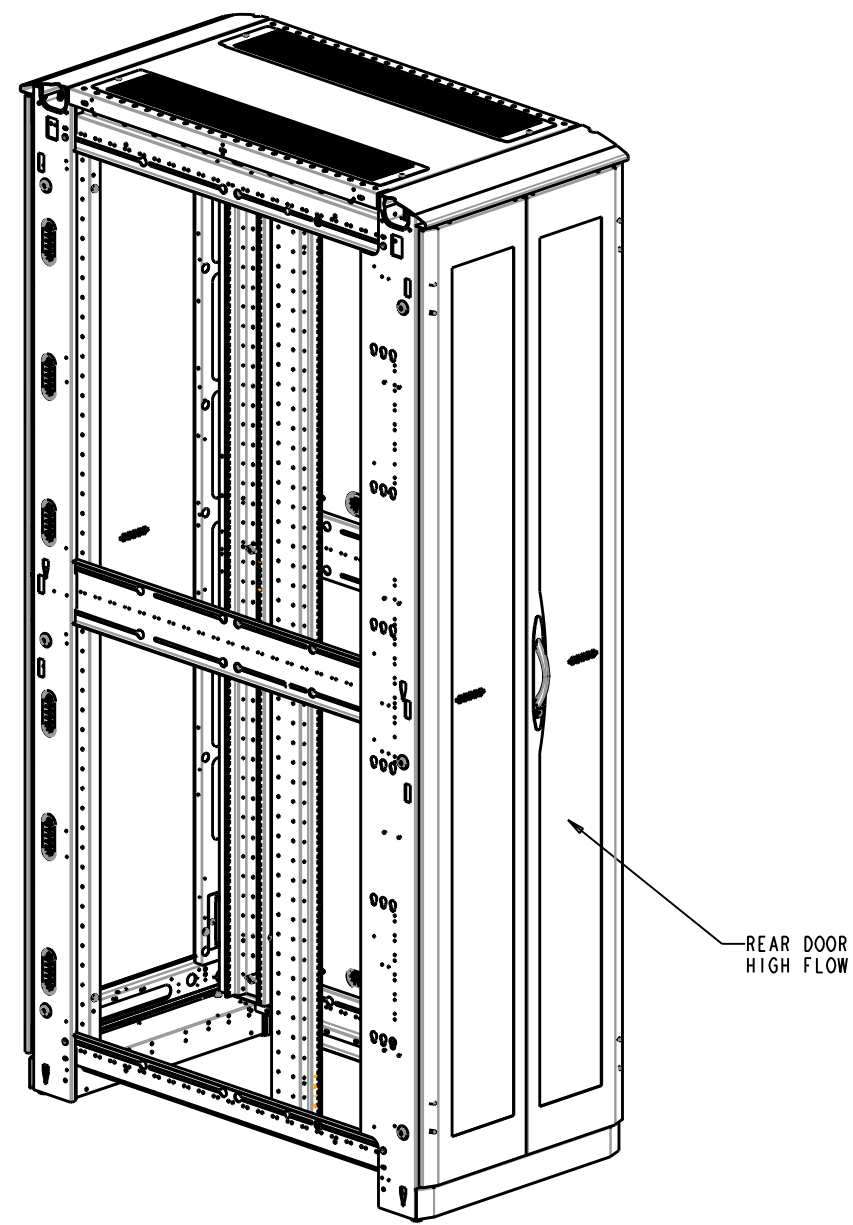

REAR ISO

SHIPPING WEIGHT: 325 LBS

REV	REV. DATE	REV'D BY	CURRENT REVISION DESCRIPTION	ECN OR EPR NUMBER
-	04/16/12	MTroio	PRODUCTION RELEASE	EPRI13430

THIS DRAWING CONTAINS PROPRIETARY INFORMATION AND IS LOANED SUBJECT TO RETURN UPON DEMAND AND UPON THE EXPRESS CONDITION THAT IT WILL NOT BE USED IN ANY WAY DETRIMENTAL TO THE INTEREST OF EATON CORPORATION

DRAWN IN THIRD ANGLE PROJECTION

TOLERANCE UNLESS SPEC'D
 .XX ± .02
 .XXX ± .005
 < ± .1
 ALL DIMENSIONS IN INCHES

CAGE NUMBER: 81824	CUSTOMER: EATON CHANNEL
DESIGN MGMT SITE: Worcester	DES. BY: MTroio 04/16/12
MATERIAL:	DRWN. BY: MTroio 04/16/12
MATERIAL FINISH:	PROD. GRP: 50 - Paramount
SPEC #:	COLOR: -
	CRS GA: N/A
	OTHER: -

EATON	
CONFIG - 48U X 24W X 48D PARAMOUNT, RACK HYGIENE	
SHEET: 1 OF 8	REV DATE: 04/16/12
D PMT482448H	REV -

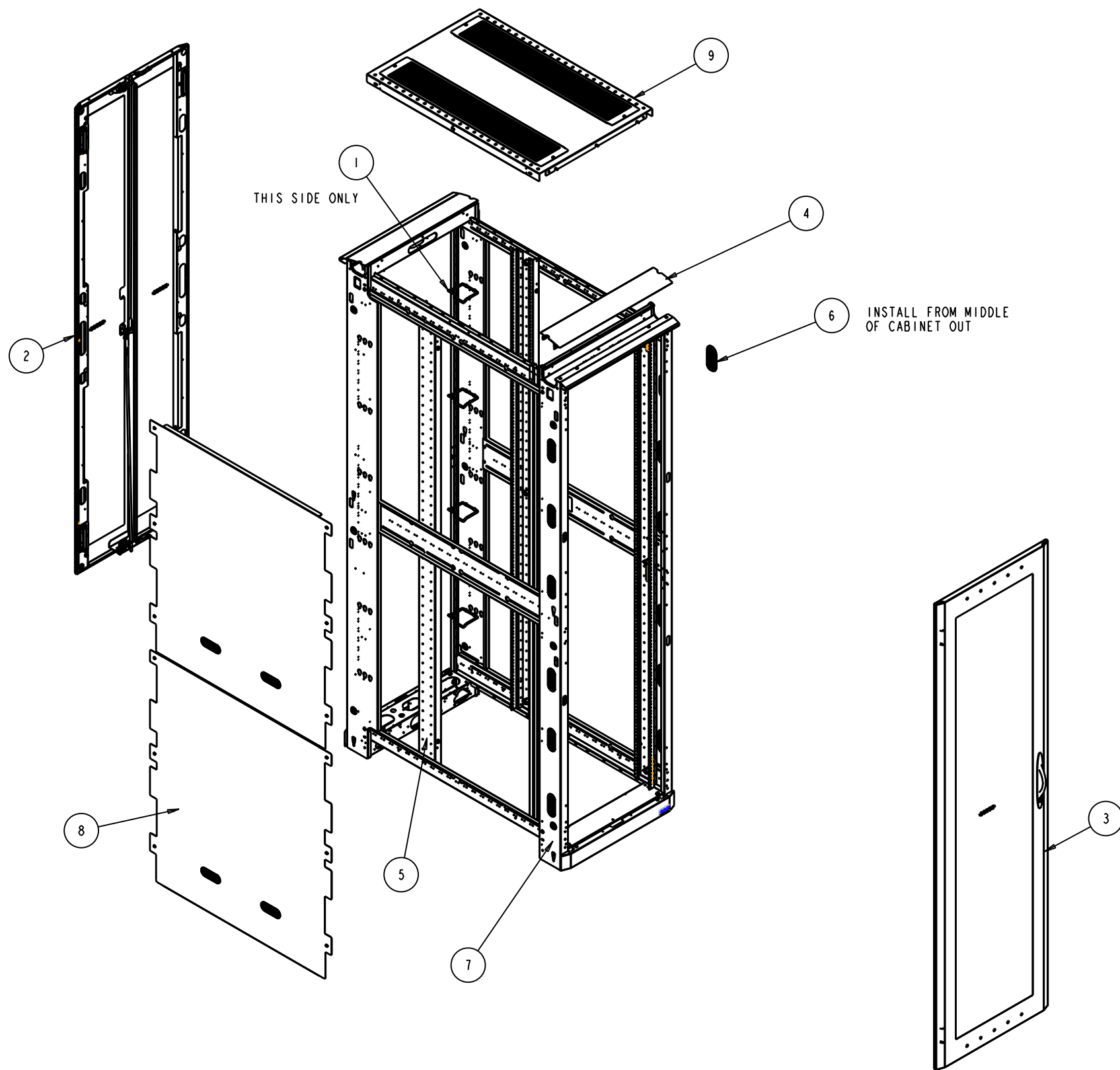

ASSEMBLY WIRING NOTE:

- GROUND ALL DOORS, RAILS, TOP AND DIVIDER PANELS. USE GROUNDING LANYARDS FROM KIT P/N GRNDPMT. USE STANDARD W/L GROUND POINTS FOR ATTACHMENT AREAS.

ITEM	TYPE	DOCUMENT #	REV	DESCRIPTION	QTY
10	SA	GRNDPMT	-	GROUND KIT - PARAMOUNT	1
9	MA	PMTNWP2448	-	ASSEMBLY - TOP PANEL, 24W X 48D	1
8	MA	PMTJVD4848S	-	DIVIDER PANEL ASY - 48U X 48D	1
7	MA	PMTFRM482445	-	WLD-FRAME, 91H X 24W X 45D	1
6	MA	JWOVLGROM	A	GROMMET - OVAL 1.5WX4L	12
5	MA	JRM4800	-	RACK MOUNT RAILS - 48U	1
4	MA	JFTK24_4591	1	FRAME TRIM KIT - 24"W	1
3	MA	JDFH9124L	-	DOOR, HIGH FLOW	1
2	MA	JDDFH9124	-	ASSEMBLY - SPLIT DOOR, HIGH FLOW	1
1	MA	CMDRNR032U_	-	D-RING KIT, 2U	1

THIS DRAWING CONTAINS PROPRIETARY INFORMATION AND IS LOANED SUBJECT TO RETURN UPON DEMAND AND UPON THE EXPRESS CONDITION THAT IT WILL NOT BE USED IN ANY WAY DETRIMENTAL TO THE INTEREST OF EATON CORPORATION

DRAWN IN THIRD ANGLE PROJECTION

TOLERANCE UNLESS SPEC'D
 .XX ± .02
 .XXX ± .005
 < ± .1"

ALL DIMENSIONS IN INCHES

CAGE NUMBER: 81824
 CUSTOMER: EATON CHANNEL
 DES. BY: MTroio 04/16/12
 DRWN. BY: MTroio 04/16/12
 DESIGN MGMT SITE: Worcester
 PROD. GRP: 50 - Paramount
 COLOR: -
 CRS GA: N/A
 OTHER: -
 MATERIAL: -
 MATERIAL FINISH: -
 SPEC #: -



CONFIG - 48U X 24W X 48D
 PARAMOUNT, RACK HYGIENE

SHEET: 2 OF 8
 REV DATE: 04/16/12

D PMT482448H REV -

REV	REV. DATE	REV'D BY	CURRENT REVISION DESCRIPTION	ECN OR EPR NUMBER
-	04/16/12	MTroio	PRODUCTION RELEASE	EPRI13430

RELEASE STATUS
Production

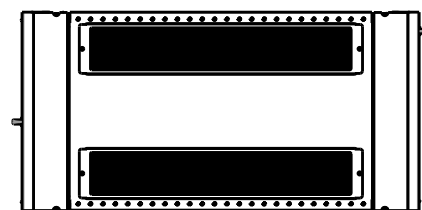

TOP

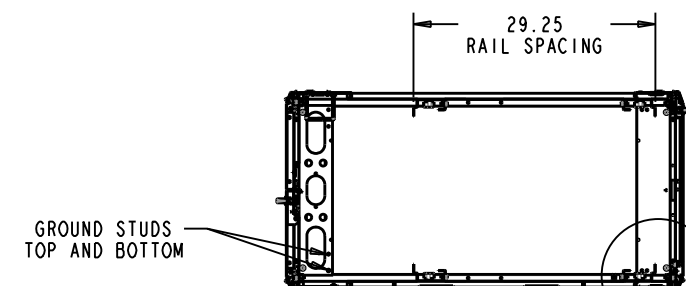

29.25
RAIL SPACING

GROUND STUDS
TOP AND BOTTOM

SECTION B-B

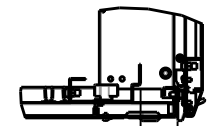

DETAIL D
SCALE 0.200

2.00 FROM FRONT
OF RAIL TO FRONT
OF CORNER POST

SEE DETAIL D

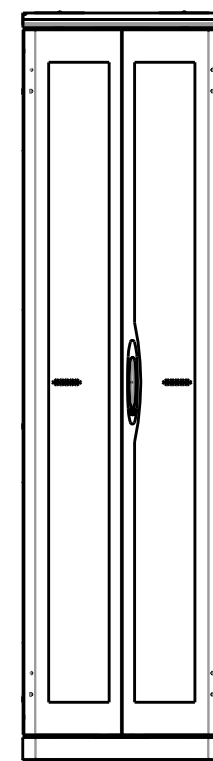

REAR

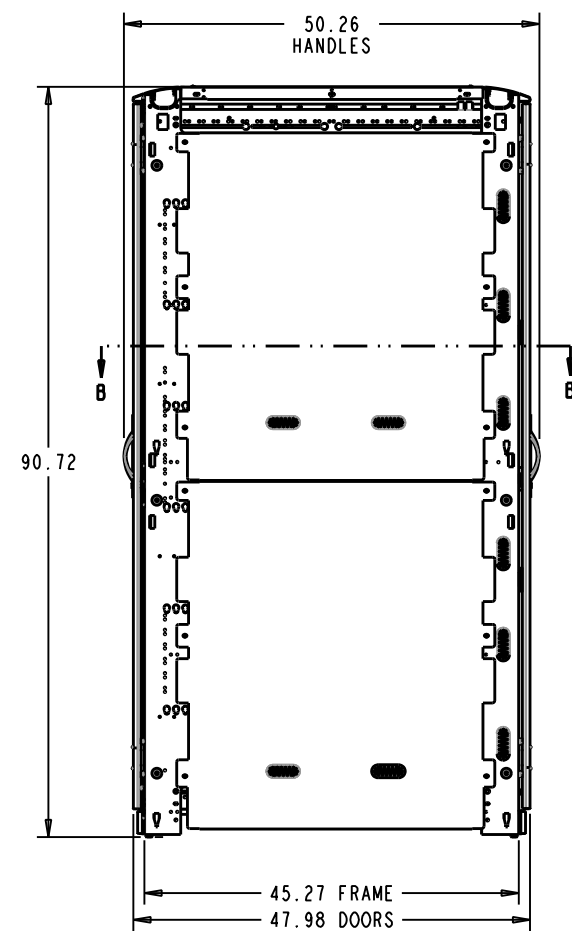

LEFT SIDE

50.26
HANDLES

90.72

45.27 FRAME
47.98 DOORS

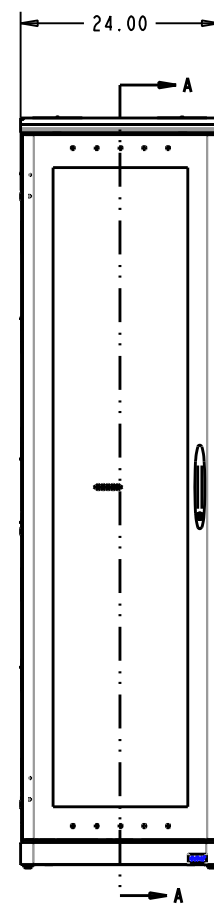

FRONT

24.00

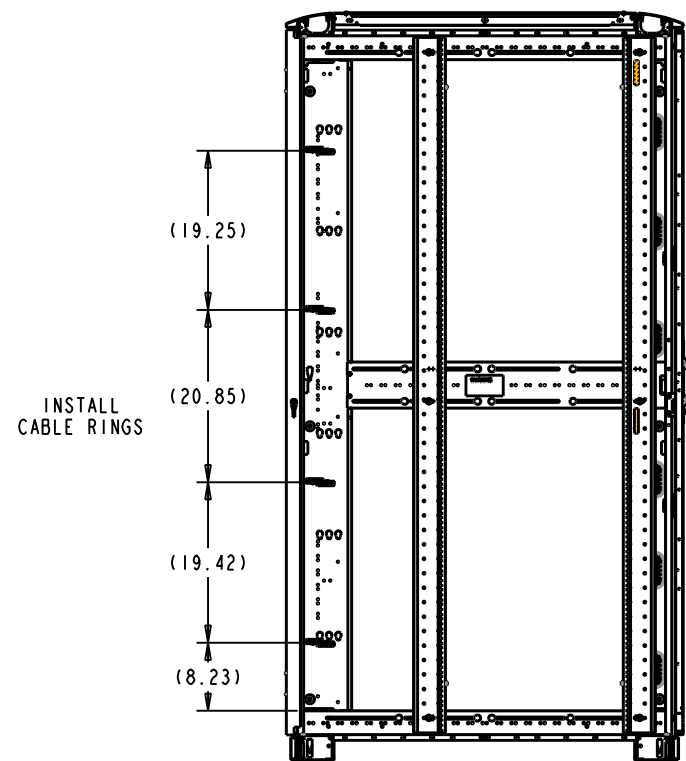

INSTALL
CABLE RINGS

(19.25)

(20.85)

(19.42)

(8.23)

SECTION A-A

SEE DETAIL A

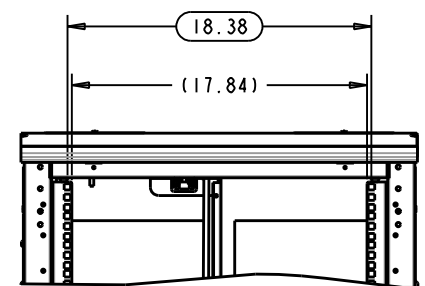
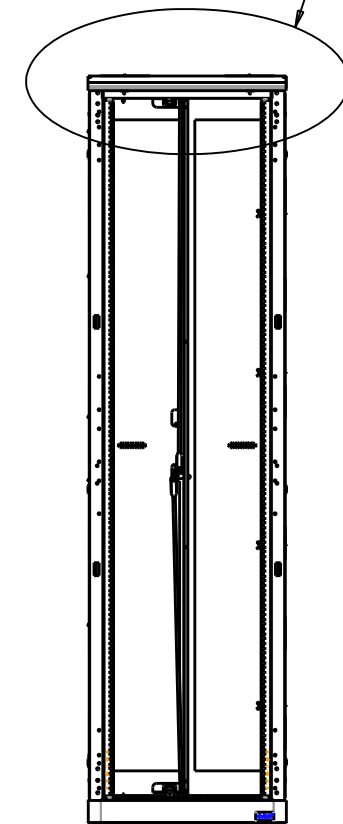

DETAIL A
SCALE 0.180

18.38

(17.84)

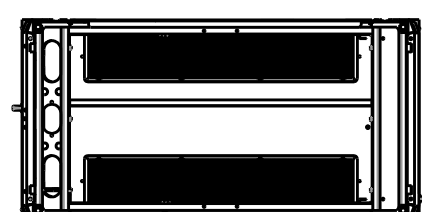

BOTTOM

LEVELING FEET

THIS DRAWING CONTAINS PROPRIETARY INFORMATION AND IS LOANED SUBJECT TO RETURN UPON DEMAND AND UPON THE EXPRESS CONDITION THAT IT WILL NOT BE USED IN ANY WAY DETRIMENTAL TO THE INTEREST OF EATON CORPORATION DRAWN IN THIRD ANGLE PROJECTION 	CAGE NUMBER: 81824		CUSTOMER: EATON CHANNEL		
	DESIGN MGMT SITE: Worcester		DES. BY: MTroio	04/16/12	
	MATERIAL: -		DRWN. BY: MTroio	04/16/12	
	MATERIAL FINISH: -		PROD. GRP: 50 - Paramount		
TOLERANCE UNLESS SPEC'D .XX ± .02 .XXX ± .005 ALL DIMENSIONS IN INCHES		OTHER: -		COLOR: -	CONFIG - 48U X 24W X 48D PARAMOUNT, RACK HYGIENE
ECN OR EPR NUMBER: EPRI13430		SPEC #: -		CRS GA: N/A	SHEET: 3 OF 8
REV		REV. DATE	REV'D BY	CURRENT REVISION DESCRIPTION	REV DATE: 04/16/12
-	04/16/12	MTroio	PRODUCTION RELEASE		D
					PMT482448H
					REV
					-

REV	REV. DATE	REV'D BY	CURRENT REVISION DESCRIPTION	ECN OR EPR NUMBER
-	04/16/12	MTroio	PRODUCTION RELEASE	EPRI13430