

VoCALL CFVCCM9 compact master & VoCALL CFVCCS10 compact master installation, commissioning and maintenance manual



Introduction

An EVCS is a fixed, secure, bi-directional, full duplex voice communication system to assist fire fighters in an emergency in high rise buildings or large sites where radio communication may not work, and covers the operation of fire telephones, disabled refuge systems and the Disabled Toilet Alarm.

The VoCALL Compact Emergency Voice Communications System (EVCS) is designed to fully comply with BS5839-Part 9:2011 (abb. Pt9) for use as a fire telephone system, disabled refuge call system or as a combined system when both fire telephones and disabled refuge points are required.

Suitability

Fire telephone systems are recommended for all public buildings and multi story buildings over four floors by BS9999.

Disabled refuge systems are required by Building Regulations Approved Document B for all non-domestic dwellings. Building Regulations Approved Document B also requires all buildings where the public or disabled staff gain access to any floor other than the ground floor using lifts or stairs are required to exit.

EATON

Powering Business Worldwide

Product overview

A VoCALL Compact unit (EVCS) comprises of two functional blocks; the master handset and outstations (type A, type B, duo, jack points or disabled toilet alarm), with the quantities of these basic units being adjusted to suit the application, a maximum of 19 outstations can be used for this system. Other sized VoCALL EVCS systems are available.

The VoCALL Compact unit (EVCS) has been designed on a star topology. In most cases this will reduce the cable requirements compared to all ring based systems. The topology consists of spurs, with each spur consisting of 1 off 2 core 1mm CSA cables (see Cable Guidance for VoCALL Network and Outstations section for cable type). Each spur can be up to 500m.

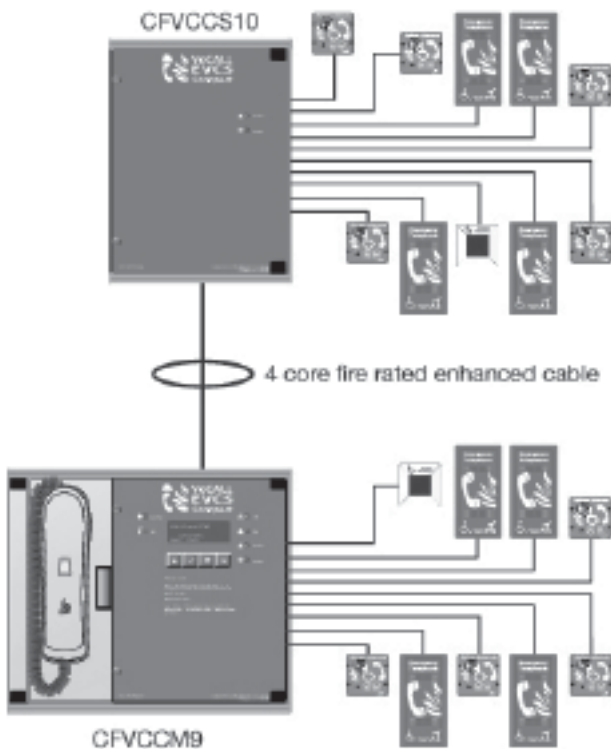

Important safety information

This equipment must only be installed and maintained by suitably skilled and competent person. This equipment is defined as Class 1 in EN60065 (Low Voltage Directive) and must be earthed.



CAUTION	INDOOR USE ONLY
WARNING	SHOCK HAZARD- ISOLATE BEFORE OPENING
WARNING	TO REDUCE THE RISK OF FIRE OR ELECTRIC SHOCK, DO NOT EXPOSE THIS UNIT IN RAIN OR MOISTURE
WARNING	THIS UNIT MUST BE EARTHED
WARNING	NO USER SERVICEABLE PARTS

Each VoCALL Compact unit requires a 3A spur, returning to a breaker clearly marked EVCS DO NOT TURN OFF. If the units are distributed around a site it is essential all units are on the same mains phase as they are classified TEN 230V, powering from different phases can mean a 440V potential can be present in a unit during a major fault incident.



Anti-static handling guidelines

Make sure that electro-static handling precautions are taken immediately before handling PCBs and other static sensitive components.

Before handling any static-sensitive items, operators should get rid of any electrostatic charge by touching a sound safety earth, such as a radiator. Always handle PCBs by their sides and avoid touching any components. PCBs should be stored in a clean, dry place that is free from vibration, dust and excessive heat.

Storing the PCBs in a suitable cardboard box will also guard them against mechanical damage.

Unpacking the VoCALL CFVCCM9 compact master unit

Remove the VoCALL Compact unit from its packing, and check the contents against the following list:

1. VoCALL CFVCCM9 Compact Master unit.
2. Installation & maintenance manual (this document).
3. User guide & logbook.
4. Accessory pack with the following contents:
 - a. Spare mains fuse.
 - b. 2.5mm AF ALN key.

Using the ALN key supplied, open the right hand front cover.

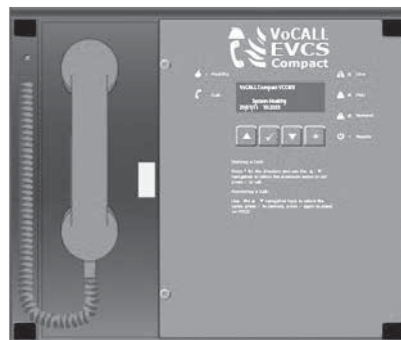

Verify the following items are present:

1. 9 off outstation line connectors
2. 1 off 2 way fault connector
3. 1 off 2 way in use connector
4. 1 off 2 way access connector
5. 1 off 4 way network connector

If there are any Items missing please contact your supplier or Cooper Safety Fire Systems, quoting the unit serial number, and the name on the packing list enclosed so we can rectify the situation.

Unpacking the VoCALL CFVCCS10 compact slave unit

Remove the VoCALL Compact unit from its packing, and check the contents against the following list:

1. VoCALL CFVCCS10 Compact slave unit.
2. Installation & maintenance manual (this document).
3. User guide & logbook.
4. Accessory pack with the following contents:
 - a. Spare mains fuse.
 - b. 2.5 mm AF ALN key.

Using the ALN key supplied, open the front cover.



Verify the following items are present:

1. 10 off outstation line connectors
2. 1 off 4 way network connector

If there are any Items missing please contact your supplier or Cooper Safety Fire Systems, quoting the unit serial number, and the name on the packing list enclosed so we can rectify the situation.

Preparation

Remove the front door plate containing the circuit board by unscrewing the door hinge. This has a connection to the base PCB, which needs to be removed. Exercise static precautions to prevent damage to the electronics. Store the front panel assembly safely until the master handset is mounted and cables have been attached.

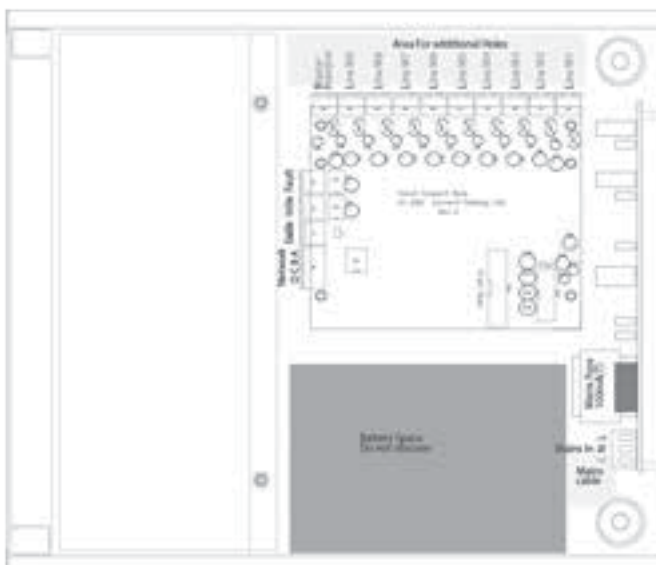

Before mounting the unit on the wall it is advisable to remove the cable knockouts. Decide how the wiring will be brought into the panel and remove the required knockouts for cable entry. If a knockout is removed, fill the hole with a good quality cable gland.

On the bottom face a single knockout is for the incoming mains. Mains SHOULD NOT enter the box by any other hole. If additional holes are required, then they can be drilled as shown below, taking care not to obscure the battery or PCB locations.

Unused knockouts must be left unopened to comply with the LVD. Accidentally knocked out holes should be blanked off. This work must be carried out prior to the re-installation of circuit boards.

Mounting VoCALL compact unit

The VoCALL Compact unit weighs 4Kgs with batteries, so care should be taken to securely mount the unit on stud walling.

Connecting VoCALL compact unit

To comply with EMC (Electro Magnetic Compatibility) regulations and to reduce the risk of electrical interference in the system wiring, we recommend the use of fire-resistant screened cables throughout the installation.

All wiring should come into the enclosure via the knockouts provided, and be fixed tidily to the relevant terminals.

Note that correct cable glanding is essential and due regard should be paid to any system specifications which demand a certain cable type (providing it meets the appropriate national wiring regulations).

Planning the wiring

All system wiring should be installed to meet the appropriate parts of BS5839-9 (2011) and BS 7671 (Wiring Regulations). Other national standards of installation should be adhered to where applicable.

Do not test wiring with an insulation tester (Megger) with any equipment or outstations connected, as the 500 Volt test voltage will destroy these devices totally.

You must observe local wiring regulations. Do not run SELV and LV cables in the same enclosure without adequate insulation between them.

Mains connection

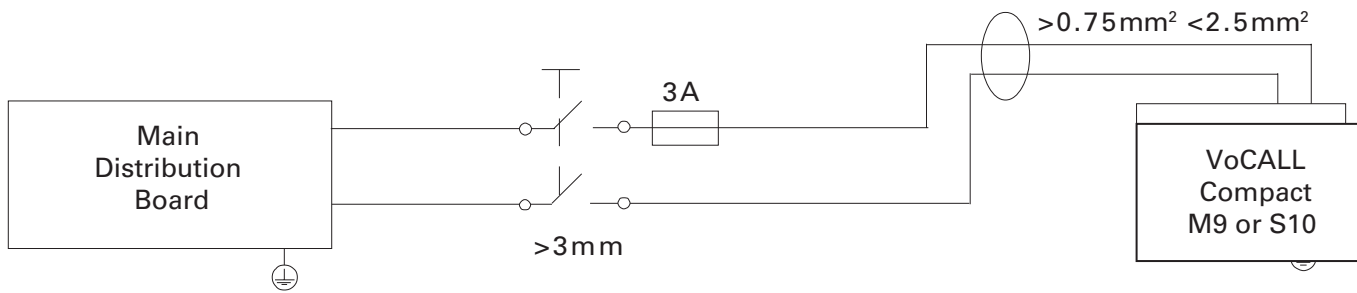

Each compact requires a 3A spur, returning to a breaker clearly marked “**EVCS DO NOT TURN OFF**”. If the units are distributed around a site it is essential all units are on the same mains phase, as they are classified TEN 230V, powering from different phases can mean a 440V potential can be present in a unit during a major fault incident.

Batteries

The compact requires one number 12V 5AH sealed lead acid batteries to provide backup power in the event of mains failure as defined in BS5839pt9 for 24 hours standby and 3 hours operation when powered by normal mains supply.

For 72hour standby and 1 hour operation one number 12V 17AH battery is required, these will need to be fitted in an external battery enclosure. The monitored charger in the VoCALL Compact unit is capable of charging and monitoring these batteries.



Safety information:

Sealed Lead acid batteries contain sulphuric acid which can cause burns if exposed to the skin. The low internal resistance of these batteries means large currents will flow if they are accidentally short circuited, causing burns and a risk of fire-exercise caution when handling batteries.

Power up procedure:

Always apply mains power before connecting batteries. Do not commission the VoCALL Compact unit on batteries, as the high inrush current required by the power supply may rupture the battery fuse. Always connect the Positive (Red +) terminal first, then the Negative (Black -)

To down power reverse the power up sequence.

Outstation wiring

The VoCALL compact unit requires programming to determine the outstation configuration;

Four types of handset are allowed on the system, type A (fixed phone) type B (hands-free refuge points), disabled toilet alarms and jack plates.

For jack points a 10K EOL resistor is required at the OUT of the last plate on the line.

Cable Guidance for VoCALL compact unit and outstations

Following the publication of BS5839pt9:2011, the guidance on cables for the VoCALL Compact unit has changed, following a relaxation in the requirements of the standard.

Type A outstations

Any system with fire fighting telephones (Type A outstations) must have all wiring to these outstations and any necessary network cables interconnecting parts of the system in Enhanced fire rated cables.

Type B outstations

In buildings under 30 metres in height, or any building with sprinklers fitted, the wiring of Type B (hands-free) disabled refuge points may be in standard fire rated cable as long as the planned evacuation will be completed within 30 minutes. If the building is over 30metres in height without sprinklers, or where the evacuation will take place over multiple stages exceeding 30 minutes, enhanced fire rated cables must be used.

Disabled toilet call points

The revised BS5839pt9:2011 now recognises the addition of disabled toilet call systems to the VoCALL Compact unit, however gives no guidance on their use, as this is in Building Regulations Approved Document M.

There is no requirement for these systems to be monitored or battery backed. However with the VoCALL VCEA toilet extension we have included these features as standard. The only cable requirement may come from the building design statement, and typically this will require low smoke and fume cables (LSF), although they can also be wired in standard fire rated cable for ease of identification.

Combined systems

When a system consists of a mix of Type A and Type B outstations, the wiring must be enhanced fire rated for any shared resource such as network cables, but individual spurs to type B outstations can be wired in standard fire rated cable as long as the distance covered by that cable does not exceed 30 metres vertically in non-sprinklered buildings, or the evacuation plan for this segment of the building will not exceed 30 minutes.

General guidance

In complex buildings or where systems are being quoted without access to the fire evacuation plan we recommend all wiring to be enhanced, or suitable caveats and detailed assumptions are placed on the design certificate required by BS5839pt9:2011.

Handsets (Type A):

Connections inside exchange unit

Connections inside telephone unit



Line - Connector on Network / Compact unit to black phone lead
 Line + Connector on Network / Compact unit to Yellow phone lead

Hands free refuge point (Type B)

Connections inside the Network / Compact unit

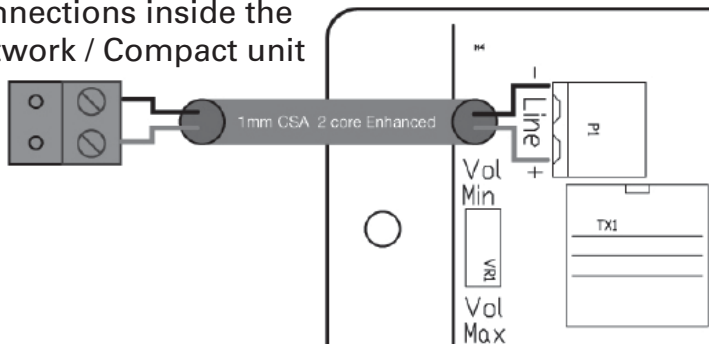

Line - Connector on Network / Compact unit to Type B line -
 Line + Connector on Network / Compact unit to Type B line +

Disabled toilet alarm

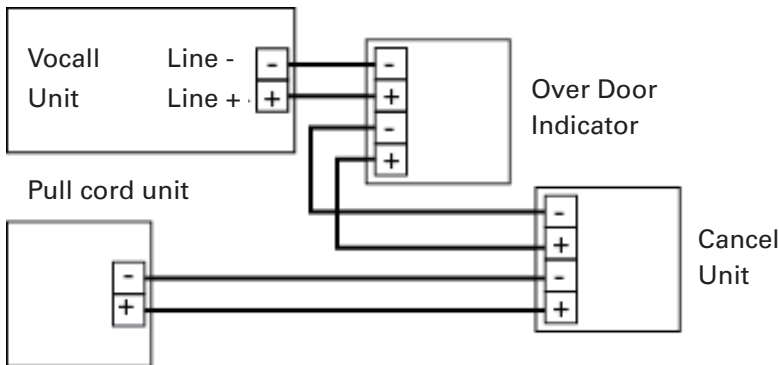

Master to slave connection

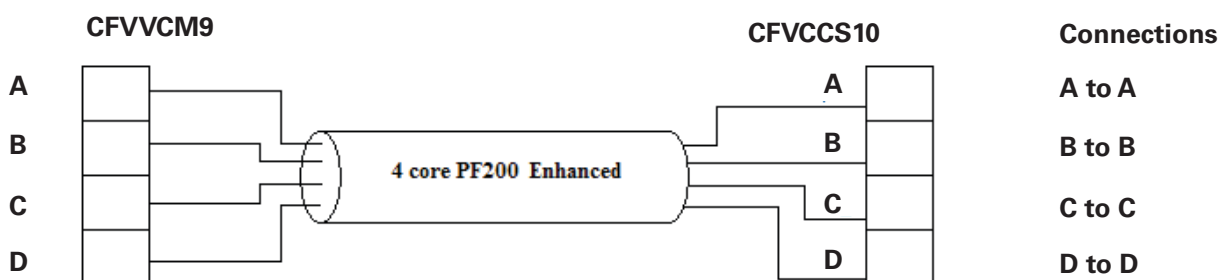

Auxiliary connections

The VoCALL Compact unit has three auxiliary connections as shown below:

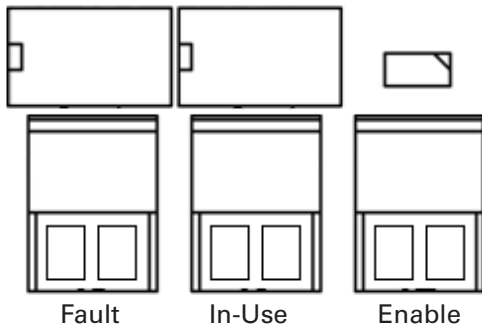

- Fault:** Is a normally closed volt free relay (30V DC 1A) which OPENS on any fault, including loss of power.
- In Use:** Is a normally open volt free relay (30V DC 1A) connection which closes when any outstation is operated.
- Enable:** Is a normally CLOSED input and is required to operate the system (if Jumper J1 is in place then no connection is required at the terminals).

2ND Fix

Replace the front panel door plate by attaching the ribbon cable lead and fixing with the door hinges.
Attach all plugs ensuring they fit squarely into the connectors.

Do not connect battery until the master has been powered up on mains.

Powering UP

Carefully check the outstation wiring then apply AC power to each VoCALL Compact master unit - DO NOT commission on batteries as the power supply has a large reservoir capacitor which may rupture the battery fuse if the AC is not present when powering up the system. Once the system is powered, the battery leads can be attached to the battery.

VoCALL CFVCCM9 programming

Status screen menu

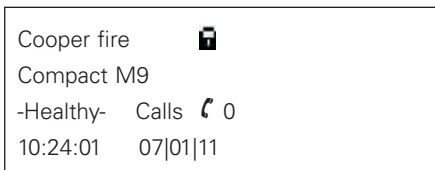

On power up, or by pressing the * key, the Status Screen Menu can be accessed.

The top line can be changed from the Set Site Name Menu. The second line can be changed from Set Panel Name Menu. The third line contains the status of the unit. The fourth line shows the current time and date.

The padlock in the top right of the display shows the state of the write protect jumper on the rear of the display PCB. This should be UNLOCKED to commission the system, and then LOCKED to prevent any unauthorised changes to the commissioned system.

Menu structure

There are 3 levels of accessibility: User, Manager, and Engineer.

- User level is accessible to all.
- Manager level is accessible to those who log in as Manager or Engineer.
- Engineer level is accessible to those who log in as Engineer.

To access the menus from the Status Screen Menu, press the TICK button.

Note: If panel is installed in a public area, then all operations will be restricted to Manager or Engineer only, except for user menus only. This includes receiving and initiating calls.

User menu

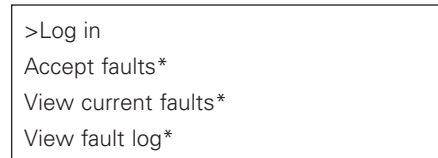

- View event log*
- View call log*
- View panel version
- Back

Note: Items marked * can be configured to display or not at user level (see later).

Manager menu

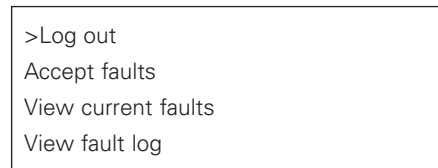

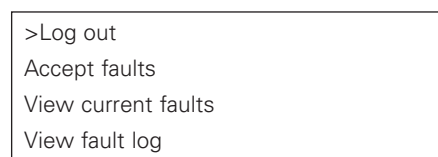

- View event log
- View call log
- View panel version
- Set time+date
- Change manager PIN

Engineer menu



- View event log
- View call log
- View panel version
- Set time+date
- Change manager PIN
- Change engineer PIN
- Log settings
- Panel settings
- Set site name
- Set panel name
- Relay settings
- Set service date
- Panel test
- Outstn settings
- Network

Navigating menus

```
Cooper fire 
Compact M9
-Healthy- Calls  0
10:24:01 07|01|11
```

The CFVCCM9 and CFVCCS10 can be configured from the front panel menu on the CFVCCM9 or via the VoCALL compact configuration software suite, however the network settings need to be configured before programming can commence. To log in to the CFVCCM9, press the TICK button to show the log in screen:

```
Compact M9
Back
>Login
View current fault
```

The log in screen will prompt the user to enter a PIN. The default Engineer PIN is 0000. Use the navigation keys to choose the correct number, and then press TICK to move to the next number. Repeat until the PIN is entered.

```
Enter PIN to LOG IN
-0***-
```

A list of possible menu options is presented. Log out will be currently selected. Use the navigation keys to select the option required, and press the TICK button.

```
Compact M9
Network
>Log out
Accept Faults
```

Log out

This option exits the configuration menu and returns the master unit back to standard operation.

Scroll through the root menu using the navigation keys until Log out is selected. Press TICK to exit.

Accept fault

This menu is only displayed when a new fault has occurred; entering this menu silences the fault buzzer and places an event in the event log, then returns the user to the main menu. The accept faults menu will now be hidden until a new fault occurs.

View current fault

This menu is an information only menu. It displays only current faults that are present on the system (if any)

```
Current faults: 1
Missing outstation 4
```

Scroll through the root menu using the navigation keys until View current fault is selected. Press TICK to enter the View current fault menu.

Use the navigation keys to scroll through the faults if there are more than three.

View fault log

This menu is an information only menu. It displays the last 99 faults that have occurred, recording the type of fault and the date and time the fault occurred.

```
Fault 1 of 3
Fault occurred
Missing outstation 4
10:56:02 01|01|11
```

Scroll through the root menu using the navigation keys until View fault log is selected. Press TICK to enter the View fault log menu.

Use the navigation keys to scroll through the faults, pressing *exits.

View event log

This menu is an information only menu. It displays the last 99 events that have occurred, recording the type of event and the date and time the event occurred. The following are classed as events: Fault acknowledgement, configuration change, log in, log out, and system initialised (on power up).

```
Event 1 of 99

Logged On
10:56:02 01|01|11
```

Scroll through the root menu using the navigation keys until View event log is selected. Press TICK to enter the View event log menu.

Use the navigation keys to scroll through the events.

View call log

This menu is an information only menu. It displays the last 999 Calls that have occurred, on this CFVCCM9.

```
Call 1 of 999
Master handset
Outstation off hook
10:56:02 01|01|11
```

Use the navigation keys to scroll through the calls.

View panel version

The View panel version option will show the CFVCCM9 current software revision and the software version of any CFVCCS10 slave attached.

```
Panel Version: Master
Version:1.0
Build:1122
Build Date 02:03:11
```

Pressing up and down will switch from master to slave, pressing TICK will exit.

Set time+date

Scroll through the root menu using the navigation keys until Set time+date is selected. Press TICK to show the Set time+date menu.

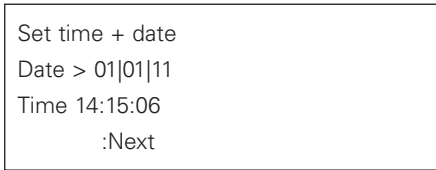

This menu shows the current date and time in the following format:

Day | Month | Year
Hour:Minute:Second

The cursor will be on the first option: Day. Use the navigation keys to select the correct day then press TICK to move to the Month option. Repeat until the current date and time are set and the next option is selected.

Most configuration menus will have the same options located in the bottom right of the LCD screen: Next, Save, and Quit. Pressing the TICK button selects the option chosen:

- Next:** Moves cursor back to first option on screen.
- Save:** Stores information and moves back to the previous menu screen.
- Quit:** Discards all information on screen, and moves back to the previous menu screen.

Use the navigation keys to select Next, Save, or Quit as desired, then press TICK. Both Save and Quit will go back to the root menu.

Change manager PIN

The default PIN to access the configuration menus is 3333, but this can be changed.

Scroll through the root menu using the navigation keys until Change manager Pin is selected. Press TICK to show the Change manager PIN menu.

There are 2 lines: New PIN and Repeat PIN. The cursor will be on the first digit of the New PIN. Use the navigation keys to change the digit, and press TICK to move to the next digit. Repeat until all digits have been entered for both the New PIN and the Repeat PIN, and the Next option is selected.

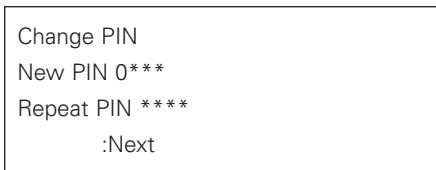

- New PIN:** PIN number that will be used to access the configuration menus.
- Repeat PIN:** New PIN repeated. If this differs from the new PIN, then the new PIN number will not be ticked, and a warning message will be displayed on screen.

Use the navigation keys to select Next, Save, or Quit as desired, then press TICK. Both Save and Quit will go back to the root menu.

Change engineer PIN

The default Engineer PIN to access the configuration menus is 0000, but this can be changed.

Scroll through the root menu using the navigation keys until Change engineer PIN is selected. Press TICK to show the Change engineer PIN menu.

There are 2 lines: New PIN and Repeat PIN. The cursor will be on the first digit of the New PIN. Use the navigation keys to change the digit, and press TICK to move to the next digit. Repeat until all digits have been entered for both the New PIN and the Repeat PIN, and the Next option is selected.



- New PIN:** PIN number that will be used to access the configuration menus.
- Repeat PIN:** New PIN repeated. If this differs from the new PIN, then the new PIN number will not be ticked, and a warning message will be displayed on screen.

Use the navigation keys to select Next, Save, or Quit as desired, then press TICK. Both Save and Quit will go back to the root menu.

Log settings

The CFVCCM9 has three independent Logs: Faults, Events and Calls. For each of these logs there is a menu to allow you to set the visibility to non-logged in users, or to clear the log (engineer only).

Scroll through the root menu using the navigation keys until Log settings is selected. Press TICK to show the Log Settings Menu.

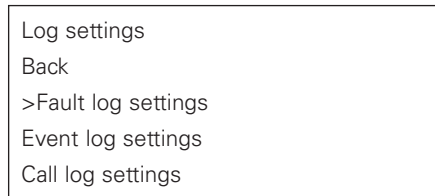

For each log, the following options are available.

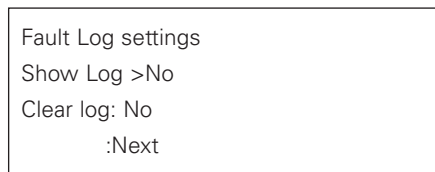

The cursor will be on the first option, Show log. Use navigation keys to select either yes or no then press TICK to move to the Clear log option. Pressing TICK again moves cursor to Next option.

Unlike other menus, the next option toggles between Next, Exec, and Quit. Use the navigation keys to select the desired option, and then press TICK.

- Next:** Moves cursor back to show log option.
- Exec:** Executes command to clear log if clear log option is set to yes, and moves back to root menu.
- Quit:** Moves back to root menu.

Panel settings

Depending upon location of install, the buzzer can operate in different modes, and the access level used to operate the panel can be set.

```
Panel settings >Next
Buzzer mode>Faulty
User flt accept: No
User access: No
```

The buzzer can operate in 3 modes:

Mute: (buzzer does not sound, which is non-compliant to British Standards)

Faulty: (buzzer only sounds when the panel is in fault)

Latched: (buzzer sounds until the faults are accepted)

User flt access determines if the faults can be accepted at user level. If Yes, then anyone can accept faults. If No, then only a manager or engineer who is logged into the panel can accept the faults.

User access determines who can operate the panel; this includes initiating and receiving calls. If the panel is located in a public area, to comply with British Standards, this must be set to No.

Set Site Name

If the site name is to be changed, scroll through the menu options until Set site name is selected, then press the TICK button.

```
Set site name
>Cooper Fire <
:Next
```

The current site name will be displayed on screen, with the cursor on the first character. Use the navigation keys to scroll to the correct character then press TICK. Repeat until the new site name has been entered.

Pressing TICK on the last character will move the cursor to the Next option. Use the navigation keys to select Next, Save or Quit as desired, then press TICK. Both Save and Quit will go back to the root menu.

Set panel name

On the system each master can be given a unique name, if the master name is to be changed, scroll through the menu options until Set panel name is selected, then press the TICK button.

```
Set panel name
>Compact M9 <
:Next
```

The current master name will be displayed on screen, with the cursor on the first character. Use the navigation keys to scroll to the correct character then press TICK. Repeat until the new site name has been entered.

Pressing TICK on the last character will move the cursor to the next option. Use the navigation keys to select Next, Save or Quit as desired, then press TICK. Both Save and Quit will go back to the root menu.

Relay Settings

The In use relay has multiple settings: None, In use, Connected, or Ignored.

None: The relay is ignored.

In Use: The relay closes when any outstation is activated. This is the default setting.

Connected: The relay closes when the master handset establishes a conversation with an outstation.

Ignored: The relay closes if the master handset is not picked up within the defined time.

```
Relay Settings
Relay> Ignored
Set Time: 0m 10s
:Next
```

Set service date

The service date is used as a reminder when the next service is due. When this date is reached, it will trigger a service fault which will remain until the service date is updated.

Scroll through the root menu using the navigation keys until Set service date is selected. Press TICK to show the Set service date menu.

```
Set service date
Date >01|06|99
:Next
```

This menu shows the currently selected service date in the following format:

Day|Month|Year

The cursor will be on the first option: Day.

Use the navigation keys to select the correct day then press TICK to move to the Month option.

Repeat until the desired next service date is set and the next option is selected.

Use the navigation keys to select next, save, or quit as desired, then press TICK.

Both Save and Quit will go back to the root menu.

Panel Test

This menu option performs various tests on the panel in line with BS5839 pt 9 2011.

There are four sub menus.

```
Panel test
Back
>Battery test
Define outstation
Outstation ring
Test indicators
```

Battery Test

This menu option performs a battery test when requested. The menu shows the current state of the PSU and the battery. Both the battery present test and the battery high impedance test are performed automatically (every 15 seconds, and every 3 hours respectively). However, this menu allows both battery tests to be performed on demand. Typically this is performed when the batteries have just been added or changed.

```
Battery test
Mains: OK
Batt : OK
Action>Quit
```

Press up or down to toggle between Quit and Retest. Press TICK to select that action.

Define outstation

This menu option will set all outstations to present. This does not permanently save all outstations as present. This is used for testing purposes only.

```
Define all handsets
Master>No
Slave:No
:Next
```

Outstation Ring

This menu option will cause all outstations to ring, for single engineer testing of a system. When an outstation is picked up it is recorded in the call log.

```
Define all handsets
Master>Start
Slave:No
:Next
```

Test indicators

This menu will sound the buzzer, and will flash all panel LEDs, except for the green power LED.

```
Test indicators
>Quit
```

Outstation settings

Scroll to the Outstn settings menu and press TICK. This menu consists of a list of all 20 possible lines (M1 through M9 on the CFVCCM9 master unit, and S1 through S10 on the CFVCCS10 slave unit, plus a back option. The outstation location is shown with the outstation line number, along with a symbol:

```
Select outstation
Ø S10-outstation 10
> Back
🔒 M9-Outstation 1
```

🔒 Unlocked: this outstation exists.

Ø Line through circle: this outstation does not exist or is in fault.

Select the outstation to be configured and press TICK.

This shows a sub menu for each outstation

```
Ø M9-outstation 1
Back
>Settings
Name
```

Settings

```
Ø M9-outstation 1
O'stn not detected
Kind>None
:Next
```

The second line of the display indicates the status of the extension (present or not detected).

Kind allows you to set the outstation type:

- None (no outstation),
- Phone (Type A handset),
- Refuge (Type B handsfree handset),
- Pullcord (disabled toilet alarm).

If an outstation is defined as a Pullcord, the master will emit a continuous tone if the toilet alarm is activated. This tone will cease when the master handset goes off hook. No call can be established with the toilet alarm.

Set name

```
Ø M9-outstation 1
Name
>Extension 1 <
:Next
```

Use the navigation keys to change the first character of the extension name, and press TICK to move to the next character. Repeat for all characters. Press TICK on the last character to move the cursor onto Next.

Use navigation keys to select Next, Save, or Quit, and press TICK to select option.

Note: if the memory is protected (locked padlock symbol shown for the exchange), then you will only be able to view this information.

The cursor will be on the Quit option. Only Next and Quit can be selected. Pressing Quit will move back to the select outstation menu.

Network settings*

The Network Settings for the VocALL CFVCCM9 Compact are only to be used for systems with the VOIP interface attached. These setting are not required for adding the CFVCCS10 slave unit.

Press TICK

```
Network
Back
>Settings
Supervisor present
Master present
Outstations
```

Pressing TICK again will show the settings menu, with the network option currently selected. If this is no, the CFVCCM9 unit will not communicate with the S10, and will be effectively isolated. If yes then the M9 unit will access the S10 slave. Use the navigation keys to toggle between the options, and press TICK to move onto supervisor.

```
Network settings
Network >No
Supervisor:No
Address:1 :Next
```

The Supervisor Menu allows this M9 to view the complete system (up to 32 M9 masters) a system can comprise each master must have its' own unique ID. These ID numbers range from 1 to 32. This node ID is used to uniquely identify the master unit. Use the navigation keys to select the node ID for this master unit, and press TICK to move to the next option.

We must now tell the system how many M9's should be present on the system:

```
Network
Settings
>Supervisor present
Master present
```

Scroll to the supervisor addresses option and press TICK.

```
Supervisor present
1=Y 2>N 3:N 4:N
:Next
```

Using the up and down keys to toggle yes or no and the TICK key to move to the next value. Set the valid addresses for masters present on the system. When you reach Next, press TICK to take you back to the start. Save will store and Quit will leave as usual. The = sign appears at the address you set in the network configuration menu as this is your address.

```
Master present :Next
1>Y 2:N 3:N 4:N
5:Y 6:N 7:N 8:N
9:Y 10:N 11:N :Next
```

Using the up and down keys to toggle yes or no and the TICK key to move to the next value. Set the valid addresses for supervisors present on the system. When you reach Next, press TICK to take you to page 2. Save will store and Quit will leave as usual.

Operation

All conversations on the VoCALL Compact unit are under the command of the CFVCCM9 master handset.

BS5289 Pt9 envisages the majority of calls to be made by lifting the handset of an outstation (Type A) or pressing the call button on a disabled refuge (Type B).

Receiving a call

When a handset is lifted or the call button is pressed on a Type B unit, the phone on the master handset will ring and the name of the calling outstation will appear on the LCD display (all outstation lines can be given a unique 18 character name to identify themselves such as "Floor 1 Riser E").

If User access is disabled, then the login page is shown instead when a call is received. Log in as either Manager or Engineer to continue onto the call page where the calling outstation is displayed.

The operator can then lift the master handset and connect to the calling outstation by pressing the TICK key. If more than one outstation is calling, all calling outstations show in the display, and may be scrolled through with the navigation buttons, connected using the TICK key, or if already connected placed on hold using the TICK key a second time.

If the CFVCCM9 master handset wishes to ring an outstation, they may do this by scrolling through the names in the directory and pressing TICK over the outstation they want.

If the outstation is defined as a pull cord (disabled toilet alarm), then a continuous tone is heard from the buzzer instead of the master handset ringing when the disabled toilet alarm is activated. This tone is silenced when the Master Handset goes off hook. This tone can also be silenced by pressing the TICK key. The tone will remain silent for 4 minutes, whereupon it will recommence. This tone signifies that the toilet alarm has been activated, and it can occur simultaneously with the Master Handset ringing due to an incoming call from a Type A or Type B handset.

Making a call

Lift the handset on the master handset, then press the * key to scroll the display to the directory page. If user access is disabled, the log in page is shown instead. Log in as Manager or Engineer to continue onto the directory page. Once in the directory use the up and down keys navigation to select the outstation name you require, and then press TICK to call. The outstation will connect when answered.

Calls cannot be initiated to any extension that is defined as a pull cord (disabled toilet alarm).

Ending or holding a call

Both call types can be ended by pressing the TICK key on the outstation line you no longer wish to call (if the bell symbol is shown).

Pressing TICK while an outstation is speaking or is off hook will place the line on HOLD (the symbol of an off hook phone is shown), you can talk to this line again by scrolling to it and pressing TICK again.

User access

Calls cannot be received nor initiated if user access is disabled until logged in as either Manager or Engineer. User access is to be disabled if the panel is located in a public area.

Once logged in, the panel can be used freely. However, there is an automatic log out after 4 minutes of inactivity. Inactivity is all handsets on hook, and the panel is not used.

If accept is pressed on status page, the Manager/Engineer menu is shown without the need for a further log in action.

If user access is enabled, then calls can be received and initiated without being logged in as Manager or Engineer.

Maintenance

It is a requirement of BS5839pt9 that a maintenance agreement be in place for the EVCS, the maintenance schedule should be as follows.

- Weekly:** Lift a different handset each week and make a call to the Master. Repeat each week until all points are tested. Record results in the site log.
- Monthly:** Test one outstation by lifting the handset, followed by the master calling that outstation. Record results in the site log.
- Quarterly:** Engineer call to check system operation.
- Yearly:** Engineer call to check system operation and check battery health.
- 5 Yearly:** Engineer call to check system operation and replace the batteries.

Technical specification

Technical specification

Product description	VoCALL Compact 9 Line Master Unit	VoCall 10 Line Slave Exchange Unit
Power supply		
Voltage	230V ac +/- 10% 50/60Hz	
Internal power supply	14V dc	
Supply and battery	Monitored, open, short, fuses	
Protection	Deep discharge, short, thermal	
Battery size and type	1 x 12V VRSLA (5Ah required)	
Mains fuse	240V 2A HRC	
Battery fuse	250A PTC	
Charge current	250mA	
Inputs		
Number of lines	9	10
Remote enable	Short to use	N/A
Outputs		
Number	2 (fault & in-use)	N/A
Type	Volt free relay	N/A
Contact	30V dc 1A	N/A
Controls		
Buttons	4 navigation keys	N/A
Display	4 lines, 20 characters	N/A
Status LEDs	3 (healthy, call & supply)	1 supply
Fault LEDs	3 (line, PSU & general)	1 general
Outstation cables		
Type	Enhanced	
Cores	2 Core (1mm or 1.5mm) Fire rated enhanced (standard fire rated cable can be used in certain circumstances - see VoCALL wiring guide)	
Distance	500m	
Network cables (for use with the 10 line slave unit)		
Type	Enhanced	
Cores	1 off 4 core (1mm CSA Soft Skin)	
Distance	10m (max) must be within fire barrier for compliance with current standards	
Physical		
Construction	Powder Coated Zintec	
Weight	6.5kg	4.8kg
Installation		
Mounting	Surface or semi-recessed	Surface
Cutout	330mm x 300mm (semi-recessed unit)	N/A
Cable entries	Top: 17 x Cable knockouts (20mm) Bottom: 1 x Cable knockouts (20mm)	

