

# ULCF3000 INSTALLATION Manual

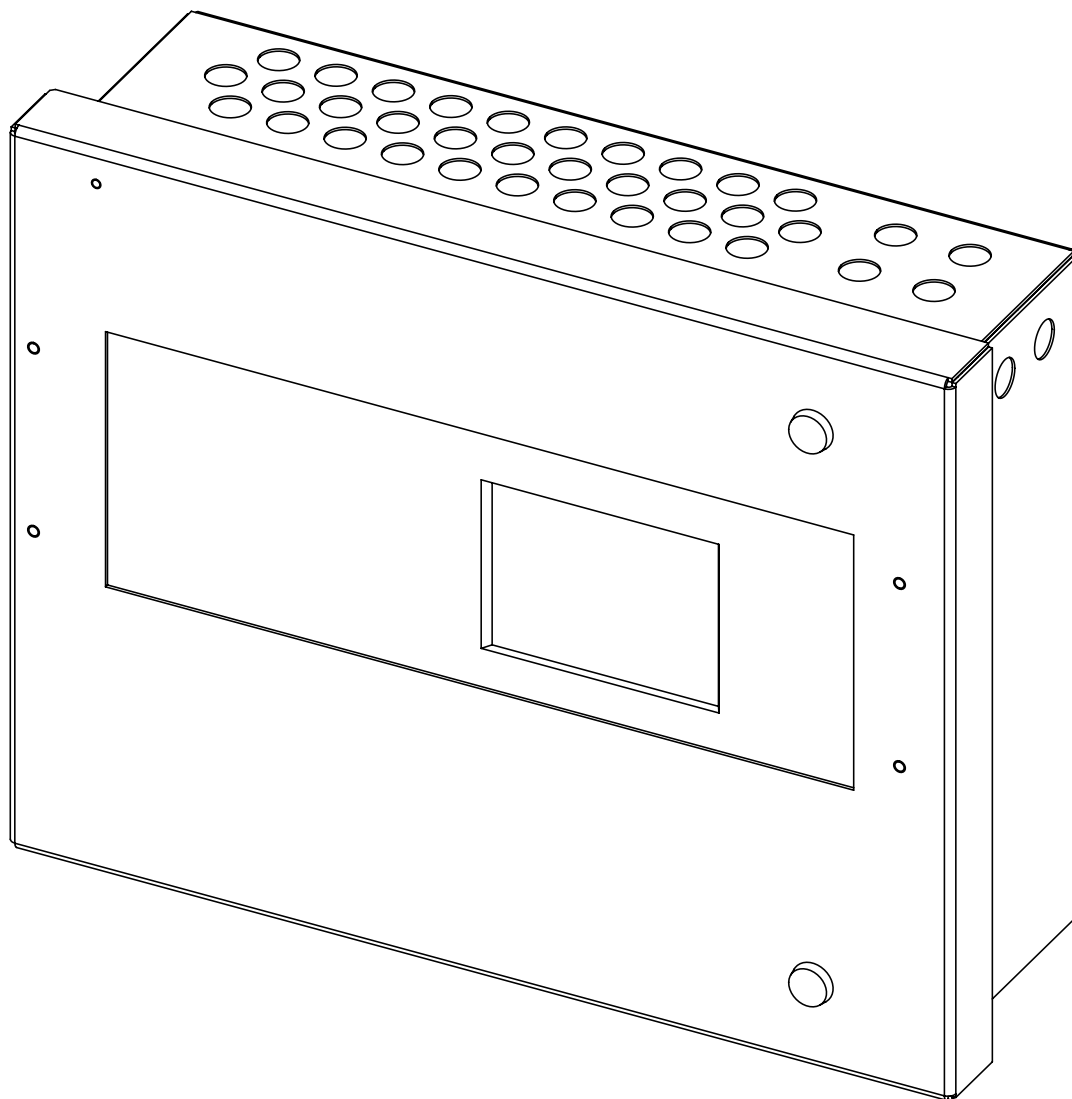

## **DISCLAIMER OF WARRANTIES AND LIMITATION OF LIABILITY**

The information, recommendations, descriptions and safety notations in this document are based on Eaton Corporation's ("Eaton") experience and judgment and may not cover all contingencies. If further information is required, an Eaton sales office should be consulted. Sale of the product shown in this literature is subject to the terms and conditions outlined in appropriate Eaton selling policies or other contractual agreement between Eaton and the purchaser.

THERE ARE NO UNDERSTANDINGS, AGREEMENTS, WARRANTIES, EXPRESSED OR IMPLIED, INCLUDING WARRANTIES OF FITNESS FOR A PARTICULAR PURPOSE OR MERCHANTABILITY, OTHER THAN THOSE SPECIFICALLY SET OUT IN ANY EXISTING CONTRACT BETWEEN THE PARTIES. ANY SUCH CONTRACT STATES THE ENTIRE OBLIGATION OF EATON. THE CONTENTS OF THIS DOCUMENT SHALL NOT BECOME PART OF OR MODIFY ANY CONTRACT BETWEEN THE PARTIES.

In no event will Eaton be responsible to the purchaser or user in contract, in tort (including negligence), strict liability or otherwise for any special, indirect, incidental or consequential damage or loss whatsoever, including but not limited to damage or loss of use of equipment, plant or power system, cost of capital, loss of power, additional expenses in the use of existing power facilities, or claims against the purchaser or user by its customers resulting from the use of the information, recommendations and descriptions contained herein. The information contained in this manual is subject to change without notice.

## Contents

<b>INTRODUCTION</b>	<b>6</b>
1.1. Fire alarm system limitations	6
1.2. Installation precautions	7
1.3. Product descriptions	7
1.4. Product features	8
1.5. Specifications	8
1.6. Controls and indication	12
1.6.1. Touch screen user button	12
1.6.2. LED Indicators	12
1.7. Panel controls and indicators	13
1.8. Fitting printer paper role	14
<b>2 INSTALLATION GUIDELINES</b>	<b>15</b>
2.1 essential please read before proceeding!	15
2.2 Agency requirements	15
2.3 Calculating current draw and standby battery	15
2.4 Calculating maximum current draw and battery backup Requirements	15
2.4.1 Detector technical characteristics UL approved	15
2.4.1.1 calibrated detector sensitivity	16
2.4.2 UL Approved audio visual devices	17
2.4.3 Examples of battery calculations	19
2.4.4 Maximum number of devices	19
2.4.5 Wiring requirement for SLC circuits	19
<b>3 INSTALLATION</b>	<b>20</b>
3.1 Mounting the enclosure	20
3.2 Earth cable on ULCF3000RM (does not apply to ULCF3000)	21
3.3 Installing cabling	21
3.4 Connecting the AC Power and earth connection	21
3.5 Battery Installation	22
3.6 Output (NAC) Installation	22
3.6.1 Class B Style Y NAC wiring using main board (Horns only)	22
3.6.2 Class B Style Y NAC Wiring using wheelock DS 12/24 (Horns & Strobes)	22
3.7 SLC Installation	23
3.8 Supervisory signal	23
Addressable devices can be programmed for supervisory signals. This input on a latching mode and requires a manual reset to restore their normal state provided the condition is cleared. Panel Relay Outputs	23
Panel relay outputs	23
<b>4 NETWORKING</b>	<b>24</b>
4.1 Battery maintenance installation cautions	25
<b>5 TECHNICAL SPECIFICATION</b>	<b>25</b>
<b>6 COMMISSIONING</b>	<b>27</b>
6.1 Configuration	28
6.2 Panel programming	28
6.3 PC Commissioning software	29
6.3.1 Device input programming	29

**ULCF3000 INSTALLATION  
Manual**

6.3.2 Isolate Zone / Address ..... Error! Bookmark not defined.

<b>7 PANEL CONTROLS &amp; INDICATORS.....</b>	<b>30</b>
7.1 Touch screen display.....	30
7.2 Panel operation.....	30
7.3 Public access level 1.....	31
7.4 Evacuate (Access level 2).....	32
7.5 Silence alarms.....	32
7.6 Acknowledge.....	33
7.7 Reset.....	33
7.8 Pre-alarms.....	34
7.9 Disabled devices.....	34
7.10 Troubles.....	34
7.11 Enable/disable (Others menu).....	34
7.12 Print.....	36
7.13 Lamp test.....	36
7.14 Weekly test.....	37
7.15 Viewing events.....	38
7.16 Check auto config.....	39
7.17 Test device (Access level 3).....	41
7.18 Test zone.....	42
7.19 Sounder level test mode.....	43
7.20 Global flashing LED on/off.....	44
7.21 One man walk test.....	45
7.22 Commission: Load CDR from Laptop.....	46
7.23 Commission: Download CDR to Laptop.....	47
7.24 Commission: Auto learn.....	48
7.25 Erase log.....	49
7.26 Change date/time.....	50
7.27 Change text.....	50
7.28 Change zone text.....	51
7.29 Change panel text.....	52
7.30 Configure zones.....	53
7.31 Change user code.....	54
7.32 Add zone.....	55
7.33 Delete zone.....	55
7.34 Add device.....	56
7.35 Delete device.....	56
7.36 Configure heat detectors.....	57
7.37 Network.....	57
7.38 Password protection.....	58
<b>8 BATTERY DISPOSAL INSTRUCTIONS.....</b>	<b>59</b>
<b>9 COMPATIBILITY TABLE.....</b>	<b>59</b>

**Note:** For maintenance recommendations refer to the NFPA 72 National Fire Alarm Code, 2007.

**Note:** Software release:  
DTS Micro: 3.03.50.xx  
Loop: 3.2.4.xx

**Note:** Install in accordance to NFPA 70, 72 (2007).  
The ULCF3000 is suitable as a Local signaling unit.  
All circuits inherently power limited except AC wiring and battery cabling.

**NOTICE TO USERS, INSTALLERS, AUTHORITIES HAVING JURISDICTION, AND OTHER INVOLVED PARTIES**

This product incorporates field-programmable software. In order for the product to comply with the requirements in the Standard for Control Units and Accessories for Fire Alarm Systems, UL 864, certain programming features or options must be limited to specific values or not used at all as indicated below.

Program feature or option	Permitted in UL 864? (Y/N)	Possible settings	Settings permitted in UL 864
Enable All / Disable All	N	Enable All / Disable All	Enable All

## Introduction

### 1.1. Fire alarm system limitations

An automatic fire alarm system – in general is made up of smoke detectors, heat detectors, manual pull stations, Call points, audible warning devices, and fire alarm control panels with remote notification capability, which can supply early warning of a developing fire. Such a system, on the other hand, is unable to assure protection against property damage or loss of life resulting from a fire.

The Manufacturer recommends that smoke and /or heat detectors must be positioned throughout a protected premise following the recommendations of the current edition of the National Fire Protection Association Standard 72 (NFPA72), manufacturer’s recommendations, State and local codes, and the recommendations contained in the Guide for Proper Use of System Smoke Detectors, which is made available at no charge to all installing dealers. A study by the Federal Emergency Management Agency (an agency of the United States government) indicated that smoke detectors may not go off in as many as 35% of all fires. While fire alarm systems are intended to provide early warning against fire, they cannot promise warning or protection against fire. A fire alarm system may not provide timely or sufficient notice, or might not function, for a diversity of reasons.

Smoke detectors may not sense fire where smoke cannot reach the detectors such as in chimneys, in or behind walls, on roofs, or on the other side of closed doors. Smoke detectors also may not sense a fire on another level or floor of a building. A second-floor detector, for example, may not sense a first-floor or basement fire.

Particles of combustion or “smoke” from a developing fire may not reach the sensing chambers of smoke detectors because:-

- Barriers such as closed or partially closed doors, walls, or chimneys may inhibit particle or smoke flow.
- Smoke particles may become “cold,” stratify, and not reach the ceiling or upper walls where detectors are located.
- Smoke particles may be blown away from detectors by air outlets.
- Smoke particles may be drawn into air returns before reaching the detector.

The amount of “smoke” present may be insufficient to alarm the smoke detectors. Smoke detectors are designed to alarm at various levels of smoke density. If such density levels are not created by a developing fire at the location of detectors, the detectors will not go into alarm.

Smoke detectors, even when working properly, have sensing limitations. Detectors that have photo electronic sensing chambers tend to detect smoldering fires better than flaming fires, which have little visible smoke. Detectors that have ionizing-type sensing chambers tend to detect fast – flaming fires better than smoldering fires. Because fires develop in different ways and are often unpredictable in their growth, both type of detector is not necessarily best and a given type of detector may not provide adequate warning of a fire.

Smoke detectors cannot be expected to provide adequate warning of fires caused by arson, children playing with matches (especially in bedrooms), smoking in bed, and violent explosions (caused by escaping gas, improper storage of flammable materials, etc.).

Heat detectors do not sense particles of combustion and alarm only when heat on their sensors increases at a preset rate or reaches a predetermined level. Rate-of-rise heat detectors may be subject to reduced sensitivity overtime. For this reason, the rate-of-rise feature of each detector should be tested at least once per year by a qualified fire protection expert. Heat detectors are designed to protect property, not life.

---

 **IMPORTANT**

---

Smoke detectors must be installed in the same room as the control panel and in rooms used by the system for the connection of alarm transmission wiring, communications, signaling, and/or power. If detectors are not located, a developing fire may damage the alarm system, crippling its ability to report a fire.

Audible warning devices such as bells may not alert people if these devices are located on the other side of closed or partly open doors or are located on another floor of a building. Any warning device may fail to alert people with a disability or those who have recently consumed drugs, alcohol or medication.

Please note that:

Strobes can, under certain circumstances, cause seizures in people with conditions such as epilepsy.

Studies have shown that certain people, even when they hear a fire alarm signal, do not respond or comprehend the meaning of the signal. It is the property owner’s responsibility to conduct fire drills and other training exercise to make people aware of fire alarm signals and instruct them on the proper reaction to alarm signals.

In rare instances, the sounding of a warning device can cause temporary or permanent hearing loss.

A fire alarm system will not operate without any electrical power. If AC power fails, the system will operate from standby batteries only for a specified time and only if the batteries have been properly maintained and replaced regularly.

Equipment used in the system may not be technically compatible with the control. It is essential to use only equipment listed for service with your control panel. Telephone lines needed to transmit alarm signals from a premise to a central monitoring station may be out of service or temporarily disabled. For added protection against telephone line failure, backup radio transmission systems are recommended.

The most common cause of fire alarm malfunction is insufficient maintenance. To keep the entire fire alarm system in excellent working order, ongoing maintenance is required as the manufacturer’s recommendations, and UL and NFPA standards. At a minimum, the requirements of NFPA 70, 72 shall be followed. Environments with large amounts of dust, dirt or high air velocity require more frequent maintenance. A maintenance agreement should be arranged through the local manufacturer’s representative. Maintenance should be scheduled

monthly or as required by National and /or local fire codes and should be performed by authorized professional fire alarm installers only. Adequate written records of all inspections should be kept.

## 1.2. Installation precautions

### WARNING

**Several different sources of power can be connected to the fire alarm control panel. Disconnect all sources of power before servicing the Control unit and associated equipment may be damaged by removing and/or inserting cards, modules or interconnecting cables while the unit is energized. Do not attempt to install, service, or operate this unit until this manual is read and understood fully.**

### CAUTION

System Reacceptance Test after Software Changes. To ensure proper system operation, this product must be tested in accordance with NFPA 70, 72 after any programming operation or change in site -specific software. Re-acceptance testing is required after any change, addition or deletion of system components, or after any modification, repair or adjustment to system hardware or wiring. All components, circuits, system operations, or software functions known to be affected by a change must be 100% tested.

In addition, to ensure that other operations are not inadvertently affected, at least 10% of initiating devices that are not directly affected by the change, up to a maximum of 50 devices, must also be tested and proper system operation verified.

This system meets NFPA requirements for indoor dry operation at 0-49° C/32-120° F and at a relative humidity of 93 ±2% RH (non-condensing) at 32 ±2° C/ 90 ±3° F. However, the useful life of the system's standby batteries and the electronic components may be adversely affected by extreme temperature ranges and humidity. Therefore, it is recommended that this system and all peripherals be installed in an environment with a nominal room temperature of 15-27°C/60-80° F.

Verify that wire sizes are adequate for all initiating and indicating device loops. Refer to manual Specifications section for maximum allowable I.R. drop from the specified device voltage.

Like all solid state electronic devices, this system may operate erratically or can be damaged when subjected to lightning-induced transients. Although no system is completely immune from lightning transients and interferences, proper grounding will reduce susceptibility. Overhead or out-side aerial wiring is not recommended, due to an increased susceptibility to nearby lightning strikes. Consult with the Technical Services Department if any problems are anticipated or encountered.

Disconnect AC power and batteries prior to removing or inserting circuit boards. Failure to do so can damage circuits.

Remove all electronic assemblies prior to any drilling, filing, reaming, or punching of the enclosure. When possible, make all cable entries from the sides or rear. Before making modifications, verify that they will

not interfere with battery, transformer, and printed circuit board location.

Do not tighten screw terminals more than 9 in-lbs. Over-tightening may damage threads, resulting in reduced terminal contact pressure and difficulty with screw terminal removal.

This system contains static-sensitive components. Always ground yourself with a proper wrist strap before handling any circuits so that static charges are removed from the body. Use static-suppressive packaging to protect electronic assemblies removed from the unit.

Follow the instructions in the installation, operating, and programming manuals. These instructions must be followed to avoid damage to the control panel and associated equipment. FACP operation and reliability depend upon proper installation by authorized personnel.

## 1.3. Product descriptions

The ULCF3000 provides all of the sophisticated features required of a leading edge analog fire system along with the simple operation and neat installation demanded by both installers and building users.

The panel can be flush or surface mounted and the generously sized metal back box allows ample facilities for rear or top cable entries.

A comprehensive range of ancillary devices is available to operate with ULCF3000, including Optical, Ionization, photo-thermal and heat detectors.

Each of the ULCF3000 system components has been specifically designed to operate as part of a ULCF3000 system, this provides an assurance that the panel, the detectors, the interfaces and the ancillaries are all fully compatible with one another and that the full range of system functionality is supported by each device.

### Fire alarm control panel models:

ULCF30002G, ULCF30004G, ULCF30002GP,  
ULCF30004GP, ULCF30002GNC, ULCF30004GNC,  
ULCF30002GPNC, ULCF30004GPNC, ULCF30002GRM,  
ULCF30004GRM, ULCF30002GPRM, ULCF30004GPRM,  
ULCF30002GNCRM, ULCF30004GNCRM,  
ULCF30002GPNCRM, ULCF30004GPNCRM,  
ULCFR3000L2, ULCFR3000L4, ULCFR3000L2NC,  
ULCFR3000L4NC.

### Designation system:

The prefix "ULCF3000" is for a stand-alone panel. The prefix "ULCF3000" is for rack-mount panels that are networked within the rack. The various control unit models differ in the following manner:

2G or L2	2-Loop panel
4G or L4	4-Loop panel
GP	2-Loop panel c/w integral printer
4GP	4-Loop panel c/w integral printer
2GNC or L2NC	2-Loop panel c/w network card
4GNC or L4NC	4-Loop panel c/w network card
2GPNC	2-Loop panel c/w integral printer, network card
4GPNC	4-Loop panel c/w integral printer, network card

Model numbers followed by suffix "RM" have a Red Metal enclosure backbox and cover.

## Introduction

### 1.4. Product features

- The Panel has the following features:
- 120mm x 90mm Touchscreen Display
- 2 or 4 SLC loops.
- Real time clock.
- Event History Buffer (9,999 events) with Date/Time stamp. Events can be displayed on Touchscreen.
- 4 Notification appliance circuits (NAC's) outputs.
- 3 programmable general purpose relays.
- Walk Test Facility
- Switchable 2 amp power supply 120/240 VAC 60 Hz.
- Dedicated alarm and trouble relays.
- Housed in a 50cm W x 4 cm H x 20 D metal cabinet.
- Cabinet supports two 12V, 7Ah backup batteries.
- Short circuit isolators incorporated into each loop.
- Spur tolerant soft addressing
- Large multifunction touch screen
- Up to 200 addresses per loop
- Fully monitored network cable up to 126 panels.
- Optional integral printer
- Alarm Verification
- PAS (Positive Alarm Sequence)
- Pre-Signal per Point (NFPA 70, 72 compliant)
- Remote Alarm Silence, Reset, Disablement and Drill via addressable modules
- User Programmable password
- Fully programmable from keypad or Local PC
- Upload and Download facility
- Facility to download Logo
- Autolearn Feature
- Battery Charger with Temperature Compensation
- Detector sensitivity

### 1.5. Specifications

#### AC Power

(see fig.1)

120 VAC 60 Hz or 240 VAC 60Hz, 2.0 Amps (L hot, N Neutral) Supervised

#### Battery (Lead acid only) J5 (see fig.1)

Maximum Charging Circuit: Normal- 27.6VDC @ 1.0amp  
The Control panel battery charge capacity is 2 X 12 AH.  
Wire batteries in series to produce a 24 Volt equivalent.  
Do not parallel batteries to increase the Amp Hour rating.  
It is recommended that the batteries are replaced every 5 years

#### SLC Circuits (see fig.1)

Communication Loop TB6, 7, 8, 9  
Addressable Loops = Max 4  
Maximum Length, see Table 9  
Maximum Loop Current is 500ma (Short Circuit) or 200 ma (nominal)  
Maximum Loop Resistance is 50 Ohms  
Supervised and power limited Operation:  
Class A, Style 6 Supervised for:  
Ground faults impedance value 0Ω

When Installing SLC wiring in conduit, each loop must be installed in separate conduit.

The total number of addresses per loop is 200; this includes detectors, call points and all other addressable items and call points. When designing systems it's recommended that allowances are made for future expansion, Short circuit isolators are incorporated into every Menvier loop device, including Smoke detectors, heat detectors, sounders, manual pulls and interfaces. Therefore, no further fault protection is required, in the event of a single fault; none of the devices connected to the loop will fail to operate as the fault will be isolated by the two adjacent devices. Spur connected devices downstream of a cable fault will cease to function.

#### Notification appliance (see fig.1)

TB11, TB12, TB13, TB14, (Horns)  
+Out1, Minus1, +Out2, Minus2 (Strobes/Horns)

4 NACs Regulated Outputs (750mA each) for Horns only using the main board (PCBA2314) or two (2) NACs for strobes/horns using Wheelock DSM 12/24 (0.5Amp total for either one NAC or shared between both NAC1, NAC2)

When the product is powered by 240V, the maximum current of 3.0 A is shared between the circuits on the main board. (cont'd)

When the product is powered by 120V, the maximum current of 2.25 A is shared between the circuits on the main board.

When determining the Notification signaling scheme, a panel may only provide power for either Horns from the main board, or Horns/Strobes from the Wheelock synch module model DSM 12/24, but not both!

Supervised for:  
Ground faults impedance value 0'Ω Regulated

#### NAC Specification

Four programmable outputs are Notification Appliance Circuit (NAC). The NAC provide the following programmable modes:

Steady – 24 VDC at alarm condition

Pulsing – 24 VDC at alarm condition

Synchronization

Cooper Wheelock DSM-12/24 R is for 11 Exceeder strobes (15cd). This module can also synchronize horns.

Power limited circuitry and supervised Operation: Style Y (Class B) Nominal Operating Voltage =24 VDC  
End of line Resistor = 6K8 1/5W 1% (part number



ULEOR6K8) Refer to device compatible document listed in table 2.

### AC trouble outputs relay TB15

Contact rating: 1.0 amp @30VDC (resistive) form C relays

### Alarm/Trouble output relay YPCB2294 TB1

Contact rating: 1.0 amp @30VDC (resistive) form C relays

### Trouble output

12V NS, 30mA;

0V Trouble

Power Limited

Limited to same room installation

Special Application – Recorded range of compatibility:

13.7Vdc – 1.8Vdc

### Network SLC

5V dc rated voltage; 100mA maximum current Maximum Line Impedance 50Ω Power Limited

**Table 1.**

Primary Operating Supply	120/240 V, 60 Hz, 2.0 A Supervised
Secondary Operating Supply	24 V dc nominal battery voltage 1.0A maximum battery charge current 0.1 Battery derating factor 12 Ah maximum battery capacity Supervised
Notification Appliance Circuits, (Class B) - Style Y Sounder Group 1 sounder 1, Sounder Group 1 sounder 2, Sounder Group 2 sounder 1, Sounder Group 2 sounder 2;	24 V dc nominal output voltage 0.75 A maximum output current 50 ohms maximum line impedance  When the product is powered by 240Vac, the maximum current of 3.0 A is shared between these circuits.  When the product is powered by 120Vac, the maximum current of 2.25 A is shared between these circuits.  Supervised, Power limited, Regulated
Notification Appliance Circuits, (Class B) - Style Y SYNC MODULE NAC1, NAC2	24 V dc nominal output voltage 0.5 A maximum output current 50 ohms maximum line impedance  The maximum current of 0.5 A is shared between these circuits.  Supervised, Power limited, Regulated
Alarm, Trouble Contacts. Relay Expansion, Fig. 7	30 V dc, 1 A, Unity power factor 30 V dc, 1 A, Unity power factor For connection to Power limited sources only
Aux Relay (AC Trouble) Contacts	30 V dc, 1 A, Unity power factor For connection to Power limited sources only
Trouble Output (TB2, RL1)	12V NS, 30mA; Trouble: 0V Power Limited Limited to same room installation Special Application: Recorded range of compatibility: 13.7Vdc – 1.8Vdc
Signaling Line Circuit Style [6] Class [A]– (Addressable Loop)	24 V dc rated voltage; 500 mA maximum current Maximum Line Impedance 50Ω [Supervised, Power limited]
Network SLC	5V dc rated voltage; 100mA maximum current Maximum Line Impedance 50Ω Power Limited Limited to Same-enclosure Installations

# Introduction

Figure 1. Typical wiring diagram

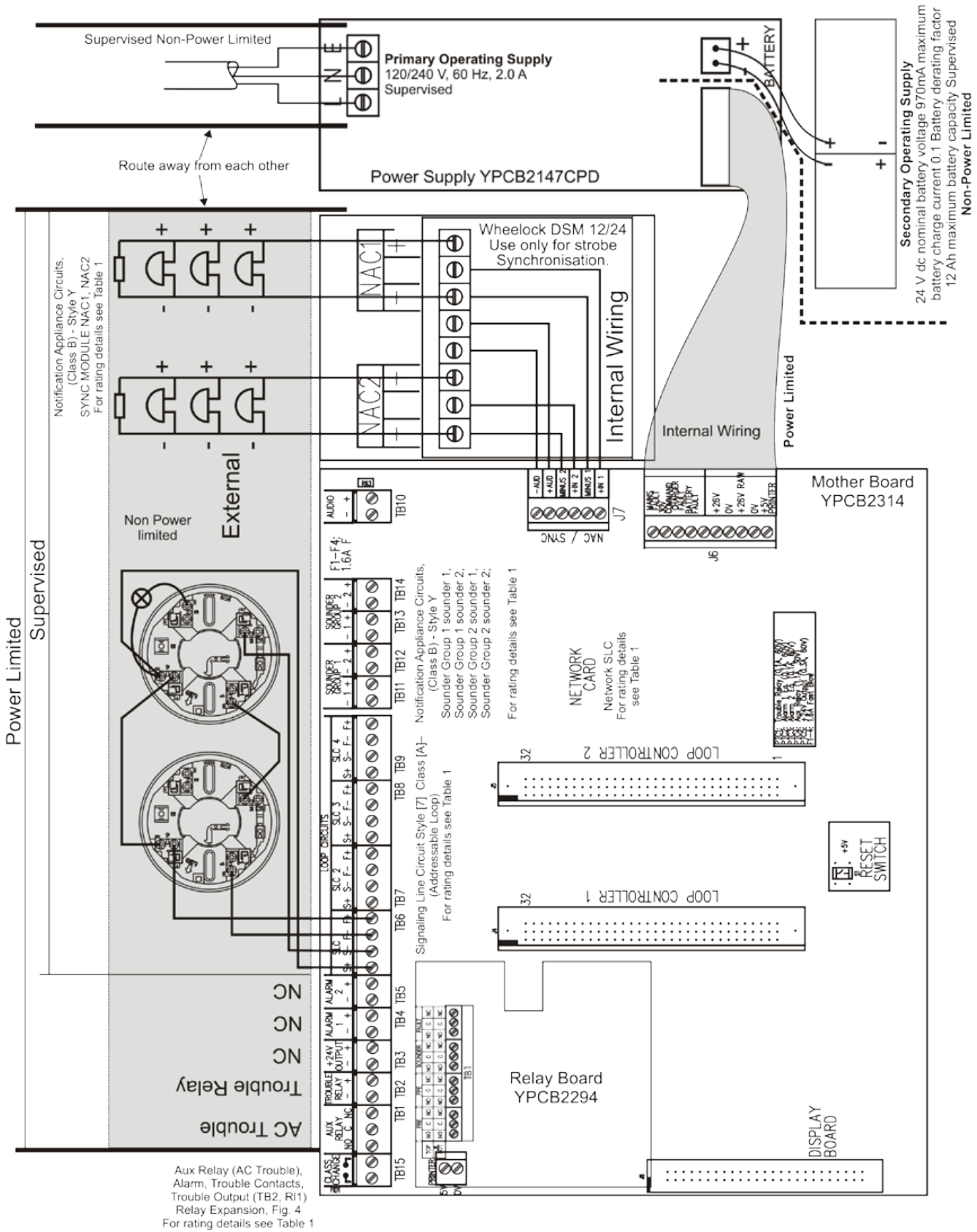



## Introduction

### 1.6. Controls and indication

#### 1.6.1. Touch screen user button

##### **Acknowledge**

This function, also abbreviated to "ACK," is used to acknowledge an abnormal situation such as an alarm or trouble condition. The acknowledge function tells the panel that building personnel or emergency responders are aware of the alarm, trouble, or supervisory condition. Acknowledging the alarm or trouble condition also normally silences the panel's own sounder.

##### **Alarm silence**

Also known as "audible silence." Depending on the configuration of the alarm system, this function will either silence the system's notification appliances completely, or will silence only the audible alarm, with strobe lights continuing to flash. Audible silence allows for easier communication amongst emergency responders while responding to an alarm. This can also be used during construction as a means of a preliminary test, before the final full test.

##### **Reset**

This resets the panel after an alarm condition. All initiating devices are reset, and the panel is cleared of any alarm conditions. If an initiating device is still in alarm after the system is reset, such as a smoke detector continuing to sense smoke, or a manual pull station still in an activated position, another alarm will be initiated.

##### **Evacuate/Drill**

This will operate all the notifications appliances as well as audible alarms as well as Panel's own sounder.

#### 1.6.2. LED Indicators

##### **Power on LED (Green LED)**

Indicator is lit, power is being provided to the system from building's electrical supply and or from the battery backup. If this indicator is lit without any other indicators also lit, then the system is in a normal condition. If no LED's are lit, then there is no power source feeding the panel

##### **General alarm LED (Red LED)**

This indicator is lit when an alarm condition exists in the system, initiated by smoke detectors, heat detectors, sprinkler flow switches, manual pull stations, manual call points, or otherwise. Along with the indicator on the panel, notification appliances, such as horns and strobes, are also activated, signaling a need to evacuate to building occupants. In an alarm condition, the fire alarm panel indicates where the alarm originated. The alarm panel can be reset once the device which initiated the alarm is reset, such as returning the handle of a manual pull station to its normal position.

##### **General trouble (Yellow LED)**

When held steady or flashing, it means that a trouble condition exists on the panel. Trouble conditions are often activated by a contaminated smoke detector or an electrical problem within the system. Trouble conditions are also activated by a zone being disabled (disconnected from the system), a circuit being disabled, low power

on the backup battery, the disabling of a notification appliance, the ground faults, or short or open circuits. The alarm panel's sounder will activate\* if a trouble condition exists. In a trouble condition, the panel displays the zone or devices causing the condition. When the situation causing the trouble condition is rectified and the panel is reset, the General trouble indicator goes out and the trouble relay will return to its normal state.

##### **System trouble LED (Yellow LED)**

Indicator is lit to indicate system malfunction or system has been rebooted

##### **Power trouble LED (Yellow LED)**

Indicator is lit and the panel internal sounder will activate\*, when there is no power being provided to the system from the Building's electrical system or from the battery backup. The touch screen display will display the cause of the trouble (AC trouble or Battery trouble).

If the trouble is due to the AC power input, the AC trouble relay will operate after a programmed delay set by the user. The delay can be set at 0, 60, 120 or 180 minutes. If the trouble condition is due to battery malfunction or battery being disconnected from the panel, the trouble relay will also activate. When the trouble recondition has been restored the panel has been manually reset, the LED and trouble relays will return to their normal state.

##### **NAC trouble LED (Yellow LED)**

Indicator is lit, the internal sounder\* and the trouble relay also activates, it means that a trouble condition exists on the panel NAC circuits. This trouble condition is often activated by a short or open of the NAC circuits. The trouble relay also activates during this condition.

When the situation causing the trouble condition is rectified and the panel is reset, the NAC trouble indicator goes out and the trouble relay will return to its normal state.

##### **Silenced LED (Yellow LED)**

This signal indicates that the system has been silenced. All notification appliances have been silenced.

##### **System test LED (Yellow LED)**

When the system is under a test condition such as "walk test," the system test led will be illuminated. This led is off when the system is restore to its normal condition

##### **Alarm silenced (Yellow LED)**

##### **Pre signal LED (Yellow LED)**

LED is lit when the pre-signal feature has been implemented.

##### **Ground trouble**

When the panel detects a ground Fault condition which indicates a short between any line extending from the panel and the Earth Ground circuits, the Ground trouble LED will be illuminated and the trouble relay will also activate during a trouble condition.

When the trouble condition has been restored and the panel has been manually reset, the LED and trouble relay will return to their normal state.

**\*Local piezo sounder**

A piezo sounder provides separate and distinct sounds for alarm, trouble and supervisory conditions as follows:

- Alarm - on steady
- Trouble - pulse 1 second on and 1 second off
- Supervisory - pulse ½ second on and ½ second off

**1.7. Panel controls and indicators**

1. System LED's
2. Zonal LED's
3. Touch screen display
4. Printer access door
5. Slot for optional printer

**Figure 3.**

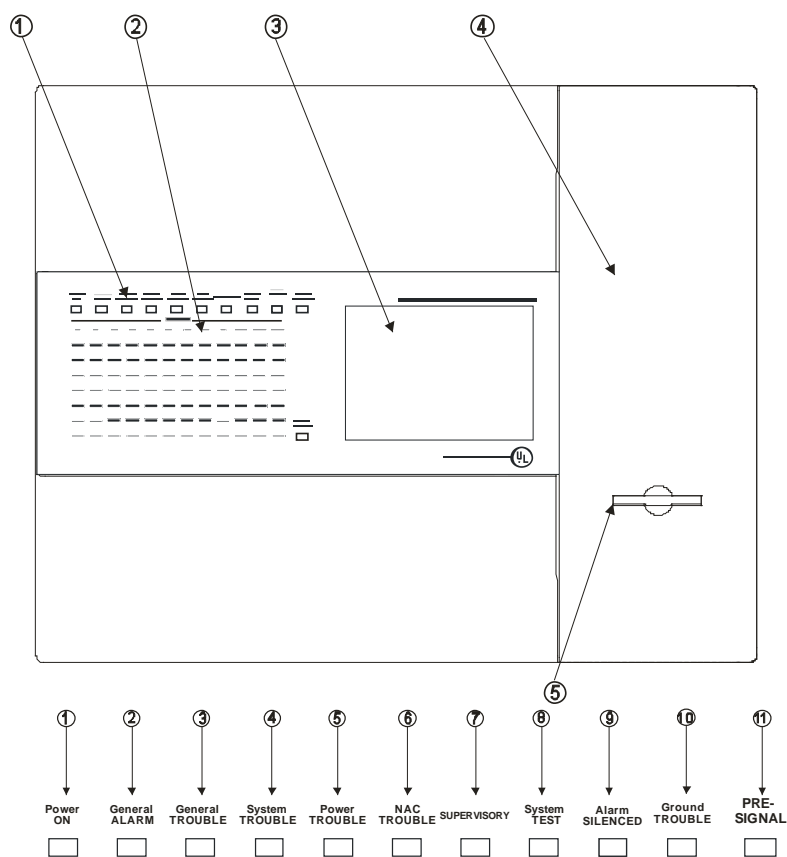

LED	Name	Function	Action
1	Power On	Shows Panel is On	Check Indicator is Illuminated
2	General Alarm	Indicators Panel has Detected a Fire	Implement Fire Action Procedure
3	General Trouble	Monitors Devices for Troubles e.g. Smoke detectors/Sounders	Report to System Supervisor
4	System Trouble	Monitors Fire Panel for Troubles	Report Fault to Service Dept
5	Power Trouble	Monitor Internal Battery Charger	Report Fault to Service Dept
6	NAC Trouble	Monitors NAC Circuits/Indicates Disablement of this Output	Report Fault to Service Dept
7	Supervisory	Part of the System has been Disabled	Report to System Supervisor
8	System Test	Indicates when System is under test	Check with System Supervisor
9	Alarm Silenced	Indicates panel has been silenced	Implement Fire Action Procedure
10	Ground Trouble	Display Activation (If Option Fitted)	Check with System Supervisor
11	Pre-Signal	Delays on Outputs Active	Check with System Supervisor

# Introduction

**Figure 4.**

1. Log book storage
2. Insert supervisor key here
3. Printer
4. Paper roll storage

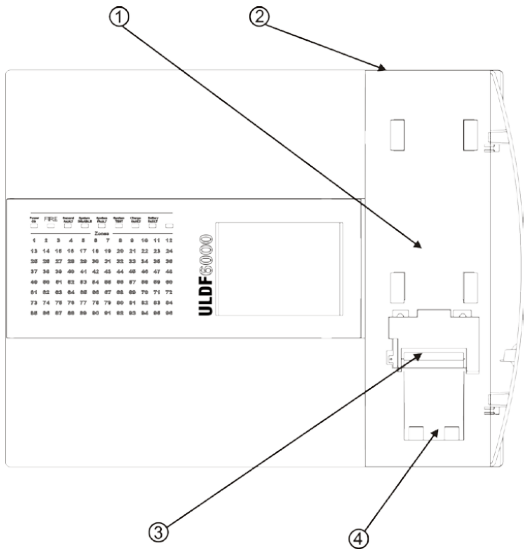

1. Optional hinged cover
2. Scroll up
3. Acknowledge
4. Scroll down

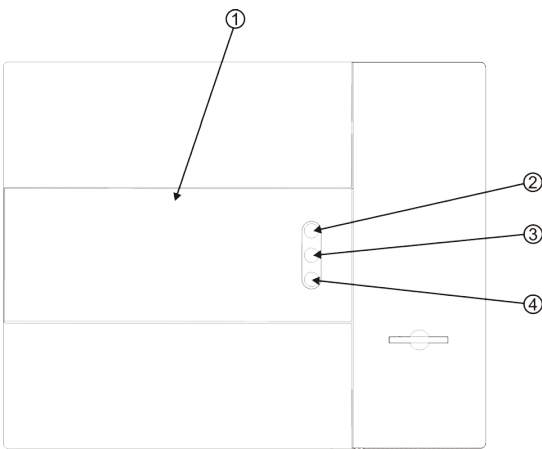

## 1.8. Fitting printer paper role

Open the printer access door on the right hand side of the panel using the key provided. Drop the paper roll into the paper holder and feed paper into the printer. The printer will then automatically pull the paper through if the panel is powered up. Tear off the excess paper then close and secure the printer access door.

Please note for paper feed to operate correctly, paper end must be straight.

**Figure 5.**

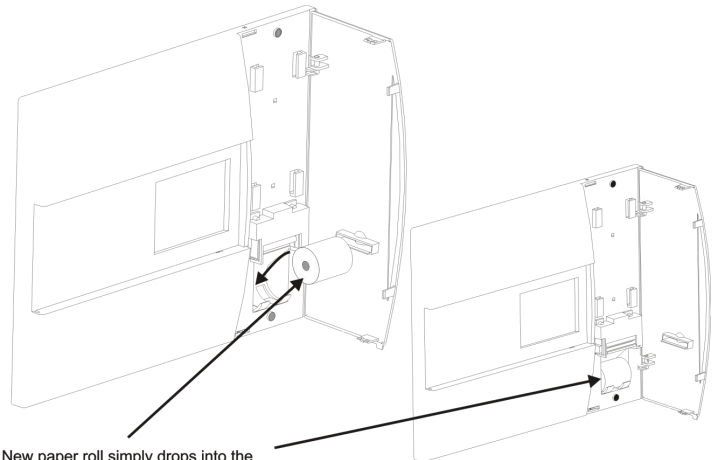

New paper roll simply drops into the holder.

Push paper underneath the roller as shown until printer automatically loads the paper. Tear off excess paper and close the printer compartment door.

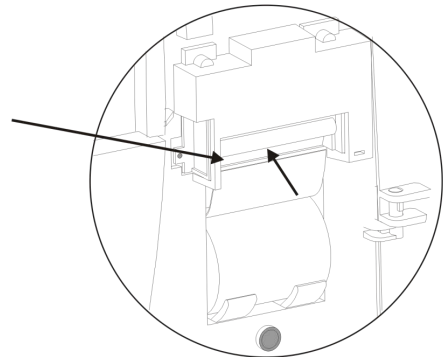

## 2 Installation guidelines

### 2.1 Essential please read before proceeding!

The equipment described in this manual is listed by UL Underwriters Laboratories, for use in fire alarm signaling systems, only when installed in accordance with this manual and the latest National Fire Protection Association Standards NFPA 72; the National Electrical Code (NFPA 70); the Life Safety Code (NFPA 101); and/or the local authority having jurisdiction (AHJ).

It is possible to apply system components incorrectly or arrange system components and installation wiring so that required life safety functions are NOT performed. As a result, lives may be lost.

To minimize this possibility:

DO NOT deviate from any installation instructions contained in this manual.

DO NOT assume any installation details not shown in this manual.

DO NOT alter any mechanical or electrical features of the equipment supplied

BE FAMILIAR with the building code, fire prevention code, and/or requirements of the Authority Having Jurisdiction (AHJ) in the locale of the installation.

---

### CAUTION

---

Under normal and fault conditions, AC line voltages may be present on any terminal. Touching any component could be hazardous and result in loss of life. A short circuit can result in arcing that could cause molten metal injuries to testing personal.

To minimize this possibility, only qualified electrical technicians familiar with electrical hazards should perform these checkout procedures. Safety glasses should be worn by such personnel, and instruments used for voltage measurement should be designed for the purpose and should be in good mechanical and working order.

If there is application or installation information that is not clear or not covered in this manual, please contact us at: Menvier Technical Support at +44 (0)1302 321541

### 2.2 Agency requirements

The PANEL is listed by UL Underwriters Laboratories to UL 864 9th edition as a FACP control unit for use in NFPA 72 systems.

Requirements for All Installations

General requirements are described in this section. When installing an individual device, refer to the specific section of the manual for additional requirements.

- All field wiring must be installed in accordance with NFPA 70 National Electric Code.
- Use UL listed smoke detectors and notification appliances compatible with the PANEL from those specified in the Appendix to this manual.
- A full system checkout must be performed every time the panel is programmed.

The ULCF3000 range of conventional fire alarm control panels are designed in accordance UL864 9th Fire Detection and Fire Alarm systems Control and Indicating Equipment.

### 2.3 Calculating current draw and standby battery

This section is to determine the current draw and standby battery needs for your installation.

Maximum Battery Standby Load

It is recommended to use the battery Yuasa Battery ([www.yuasabatteries.com](http://www.yuasabatteries.com)). The required nominal batteries capacity as versus standby current system is shown in the table below (1-1).

Make sure that for the system configuration the standby is not more than 0.41 A for 12 Ah battery.

**Table 2.**

Battery Model	Capacity, Ah	Size , mm			Maximum permissible System Standby current during 24 h
		L	W	H	
NP12-12	12	151	99	101	0.4100

### 2.4 Calculating maximum current draw and battery backup requirements

This section will assist you in determining the maximum system current draw and standby battery needs for your installation. Follow the steps below to determine the current draw and standby battery requirements.

Total standby and alarm current is determined by multiplying the quantity of items by its current draw. To quickly determine maximum system current draw, perform the following computations:

Fill in the quantities of conventional detectors, addressable detectors and devices.

Fill in the quantities and current draw of the Notification Appliances or auxiliary-powered devices for each output from the manual for each specific device.

Fill in the total quantities of detectors and modules. The detectors and modules total alarm current is determinate by estimation method, under the hypothesis that 5% LED will be ON.

The required battery capacity is determined according to equation:

$$C_b \geq (I_{sb} * T_{sb} + I_a * T_a) * 1.1$$

**Where:**

$C_b$	required battery capacity, Ah
$I_{sb}$	standby current, A
$T_{sb}$	supervisory time, 24hours
$I_a$	alarm current, A
$T_a$	alarm time, 5 min (0.0833 hours)
1.1	safety factor.

Make sure the total alarm current you calculated (including current for the panel itself) does not exceed 4.0 Amps. This is the maximum alarm current allowable.

The calculation example is shown in the table 8.

## 2 Installation guidelines

### 2.4.1 Detector technical characteristics UL approved

**Table 3.**

<b>Detector Head</b>	<b>ULCAP320</b>	<b>ULCAPT340</b>	<b>UCAH330</b>
Base	WBA or UCAB300	WBA or UCAB300	WBA or UCAB300
Working Voltage	18-30Vdc	18-30Vdc	18-30Vdc
Voltage Waveform	Filtered dc +/- 1v max ripple @120Hz	Filtered dc +/- 1v max ripple @120Hz	Filtered dc +/- 1v max ripple @120Hz
Standby Current (Average)	220 uA	220 uA	220uA
Alarm Current (max)	5 mA	5 mA	5 mA
Relay Current (max)	N/A	N/A	N/A
Start-up Time	2 seconds	2 seconds	2 seconds
Sensitivity	2.55+/- 0.33%/ft	2.55+/- 0.33%/ft	N/A
Sensitivity use checker	Use No-Climb TRUTEST UL Listing 77TL	Use No-Climb TRUTEST UL Listing 77TL	Use No-Climb TRUTEST UL Listing 77TL
Heat Element rating	N/A	135°F	135°FROR +Fixed + Fixed *135°F Fixed
Reset Time (max)	2 seconds	2 seconds	2 seconds
Heat Detector	N/A	50ft (heat alone operation)	50ft
Ambient Temperature	32-100°F	32-100°F	32-100°F 32-50°F (194°F)
Mounting Position	Ceiling in open areas	Ceiling in open areas	Ceiling in open areas
Compatibility Identifier	W002	W002	W002

#### 2.4.1.1 Calibrated detector sensitivity

**Table 3**

<b>Part Code</b>	<b>Type</b>	<b>Normal</b>	<b>Pre-Alarm</b>	<b>Alarm</b>	<b>Trouble</b>
ULCAP320	Optical	10 – 49 (Nominal 20)	50 – 59	60 – 255	0 – 10
ULCAPT340	Optical Heat	10 – 49 (Nominal 20)	50 – 59	60 – 255	0 – 10

Normalized smoke detector value versus %/Ft:

**Table 4.**

<b>Normalised Smoke detector response</b>	<b>ULMAP320 &amp; ULMAPT340</b>
20	0%/Ft
50	1.91%/Ft
60	2.55%/Ft



2.4.2 UL Approved audio visual devices

Table 5. Notification appliances

*Horn strobe ratings per UL 1971 & UL 464 at 24 Vdc*

		UL Max Current* at 99 dB(A)													
		24 Vdc												12 Vdc	
Mode	Regulated Voltage Range Vdc	15	15/75	30	60	75	95	110	115	135	150	177	185	15	15/75
HS	8.0-33.0	0.082	0.095	0.102		0.148	0.176	0.197		0.242			0.282	0.125	0.159
HSC	8.0-33.0	0.082		0.102	0.141	0.148	0.176		0.197		0.242	0.282		0.125	

*Horn strobe ratings per UL 1971 & UL 464 at 24 Vdc*

		UL Max Current* at 95 dB(A)													
		24 Vdc												12 Vdc	
Mode	Regulated Voltage Range Vdc	15	15/75	30	60	75	95	110	115	135	150	177	185	15	15/75
HS	8.0-33.0	0.073	0.083	0.087		0.139	0.163	0.186		0.230			0.272	0.122	0.153
HSC	8.0-33.0	0.073		0.087	0.128	0.139	0.163		0.186		0.230	0.272		0.122	

*Horn strobe ratings per UL 1971 & UL 464 at 24 Vdc*

		UL Max Current* at 90 dB(A)													
		24 Vdc												12 Vdc	
Mode	Regulated Voltage Range Vdc	15	15/75	30	60	75	95	110	115	135	150	177	185	15	15/75
HS	8.0-33.0	0.065	0.075	0.084		0.136	0.157	0.184		0.226			0.267	0.120	0.148
HSC	8.0-33.0	0.065		0.084	0.120	0.136	0.157		0.184		0.226	0.267		0.120	

Table 6. Product codes

Part Code	Description
HSR	Wall mounted horn strobe
HSWC	Ceiling mounted horn strobe
HNR	Wall mounted horn
HNWC	Ceiling mounted horn
STR	Wall mounted sync strobe
STWC	Ceiling mounted sync strobe
RSSWP-2475-FR	Weatherproof wall mounted sync strobe
RSSWP-2475C-FW	Weatherproof ceiling mounted sync strobe

## 2 Installation guidelines

**Table 7. Examples of battery calculations**

SYSTEM COMPONENTS	QUANTITY OF DEVICE/MODULE	QUANTITY OF DEVICE/MODULE IN ALARM CONDITION MAXIMUM	STAND-BY CURRENT (Amps)	MAXIMUM ALARM CURRENT (Amps)	TOTAL STAND-BY CURRENT (Amps)	TOTAL ALARM CURRENT (Amps)
Main System on Standby (Loop + Mother Board + Display + Network Card)	1		0.23		0.23	
Panel in Alarm (As above + Synch Module+ Relay Board+ Zonal Led's)				0.27		0.27
<b>Loop 1</b>						
Photoelectric smoke sensor ULCAP320	100	5	0.00022	0.005	0.022	0.025
Multi-mode heat sensor UCAH330	50	0	0.00022	0.005	0.011	0
Photo-thermal smoke sensor ULCAPT340	50	0	0.00022	0.005	0.011	0
Spur isolator unit ULCSI350	0	0	0.00030	0.00030	0	0
Zone Monitor Unit ULZMU352	0	0	0.0049	0.005	0	0
3 Channel I/O unit ULCIO351	0	0	0.00114	0.00136	0	0
Single input module ULMCIM-C & ULMCIM	0	0	0.00032	0.00032	0	0
Single output module ULMCOM_S&ULMCOM	0	0	0.00032	0.00032	0	0
Loop-mounted repeater ULCF3000PR	0	0	0.00031	0.00035	0	0
4 way sounder controller ULCSC354	0	0	0.00041	0.0054	0	0
Shop unit monitor ULSUM355	0	0	0.00490	0.005	0	0
120/240 Single Channel IO ULCMIO353	0	0	0.00033	0.00039	0	0
Low Cost ZMU ULMIU872	0	0	0.00490	0.005	0	0
<b>Loop 2</b>						
Photoelectric smoke sensor ULCAP320	100	5	0.00022	0.005	0.022	0.025
Multi-mode heat sensor UCAH330	50	0	0.00022	0.005	0.011	0
Photo-thermal smoke sensor ULCAPT340	50	0	0.00022	0.005	0.011	0
Spur isolator unit ULCSI350	0	0	0.00030	0.00030	0	0
Zone Monitor Unit ULZMU352	0	0	0.0049	0.005	0	0
3 Channel I/O unit ULCIO351	0	0	0.00114	0.00136	0	0
Single input module ULMCIM-C & ULMCIM	0	0	0.00032	0.00032	0	0
Single output module ULMCOM_S&ULMCOM	0	0	0.00032	0.00032	0	0
Loop-mounted repeater ULCF3000PR	0	0	0.00031	0.00035	0	0
4 way sounder controller ULCSC354	0	0	0.00041	0.0054	0	0
Shop unit monitor ULSUM355	0	0	0.00490	0.005	0	0
120/240 Single Channel IO ULCMIO353	0	0	0.00033	0.00039	0	0
Low Cost ZMU ULMIU872	0	0	0.00490	0.005	0	0
<b>Loop 3</b>						
Photoelectric smoke sensor ULCAP320	100	5	0.00022	0.005	0.022	0.025
Multi-mode heat sensor UCAH330	50	0	0.00022	0.005	0.011	0
Photo-thermal smoke sensor ULCAPT340	50	0	0.00022	0.005	0.011	0
Spur isolator unit ULCSI350	0	0	0.00030	0.00030	0	0
Zone Monitor Unit ULZMU352	0	0	0.0049	0.005	0	0
3 Channel I/O unit ULCIO351	0	0	0.00114	0.00136	0	0
Single input module ULMCIM-C & ULMCIM	0	0	0.00032	0.00032	0	0
Single output module ULMCOM_S&ULMCOM	0	0	0.00032	0.00032	0	0
Loop-mounted repeater ULCF3000PR	0	0	0.00031	0.00035	0	0
4 way sounder controller ULCSC354	0	0	0.00041	0.0054	0	0
Shop unit monitor ULSUM355	0	0	0.00490	0.005	0	0
120/240 Single Channel IO ULCMIO353	0	0	0.00033	0.00039	0	0
Low Cost ZMU ULMIU872	0	0	0.00490	0.005	0	0

Loop 4						
Photoelectric smoke sensor ULCAP320	100	5	0.00022	0.005	0.022	0.025
Multi-mode heat sensor UCAH330	50	0	0.00022	0.005	0.011	0
Photo-thermal smoke sensor ULCAPT340	50	0	0.00022	0.005	0.011	0
Spur isolator unit ULCSI350	0	0	0.00030	0.00030	0	0
Zone Monitor Unit ULZMU352	0	0	0.0049	0.005	0	0
3 Channel I/O unit ULCIO351	0	0	0.00114	0.00136	0	0
Single input module ULMCIM-C & ULMCIM	0	0	0.00032	0.00032	0	0
Single output module ULMCOM_S&ULMCOM	0	0	0.00032	0.00032	0	0
Loop-mounted repeater ULCF3000PR	0	0	0.00031	0.00035	0	0
4 way sounder controller ULCSC354	0	0	0.00041	0.0054	0	0
Shop unit monitor ULSUM355	0	0	0.00490	0.005	0	0
120/240 Single Channel IO ULCMIO353	0	0	0.00033	0.00039	0	0
Low Cost ZMU ULMIU872	0	0	0.00490	0.005	0	0
AC Trouble Relay (0.025 Quiescent)	1		0	0	0	0
Trouble relay coil current (0.025 Quiescent)	1		0	0	0	0
					0	
Alarm Trouble	1		0	0.025	0	0.025
LON Card	0		0.035	0.035	0	0
Network-mounted repeater ULCFTR3000					0	0
NOTIFICATION APPLIANCES						
NAC # 1	1			0.75	0	0.75
NAC # 2	1			0.75	0	0.75
NAC # 3	1			0.75	0	0.75
NAC # 4	1			0.75	0	0.75
A)Supervisory (Standby) Current, (A)	0.406		0.28936	3.39	0.406	3.395
B)Supervisory Time(24 hours)	24					
C)Supervisory requirements(A*B)	9.744					
D)Alarm Current	3.395					
E)Alarm time hours (5min=0.0833,10min=0.167)	0.0833					
F)Alarm Requirement	0.2828035					
G)Battery backup (C+F)	10.026804					
H)10% Safety Factor (=G*.1)	1.0026804					
I)Battery Requirement with 10% safety factor(=G+H)	11.029484					
REQUIRED BATTERY SIZE Ah	12					

**Table 8. Examples of battery calculations**

**2.4.3 Maximum number of devices**

The maximum number of Menvier addressable devices per SLC circuit is 200. The Menvier Panel can support up to 4 SCL circuit, a total of 800 addressable devices.

**2.4.4 Wiring requirement for SLC circuits**

Must meet the National Electric Code 760-51 requirements for power limited fire protective signaling cables.

Maximum wiring resistance is 50 ohms and maximum loop length depends on the wire gauge as per below.

**Table 9.**

Wire Gauge	22AWG	18AWG	16AWG	14AWG
mm <sup>2</sup>	.34	1.0	1.5	2.5
Maximum Distance	1500 feet	3900 feet	6200 feet	10,000 feet

### 3 Installation

#### 3 Installation

Read all the installation instructions before commencing with the installation. The installation of this panel must be carried out by a suitably qualified /trained person.

With the hinge mounting on the left, determine the number of conductors required for the devices to be installed. Sufficient knockouts are provided for wiring convenience.

Select the appropriate knockout(s) and pull the conductors into the box. All wiring should be in accordance with the National and/or Local codes for fire alarm systems.

##### 3.1 Mounting the enclosure

The ULCF3000 and ULCF3000RM can be flush mounted or surface mounted.

Install the Enclosure as follows:

1. Carefully unpack the system components and inspect for any damage due to shipping.

2. Mount the enclosure in a clean, dry, vibration-free area where extreme temperatures are not encountered. The location should be readily accessible with sufficient room for easy installation and maintenance.
3. Locate the top of the cabinet approximately 5 feet (1.5 m) above the floor.
4. Mount by using the two mounting holes located in the upper back of the cabinet. After the panel has been properly located using the mounting holes, the panel can be secured.
5. Complete all conduit connections to the cabinet. Use the knockouts provided in the top and the sides.
6. Wire must NOT enter the bottom of the cabinet, since this area is intended for batteries only.

The electronic components within the fire panel are Static Sensitive. Do not touch the electronics directly.

Figure 6. Panel mounting dimensions

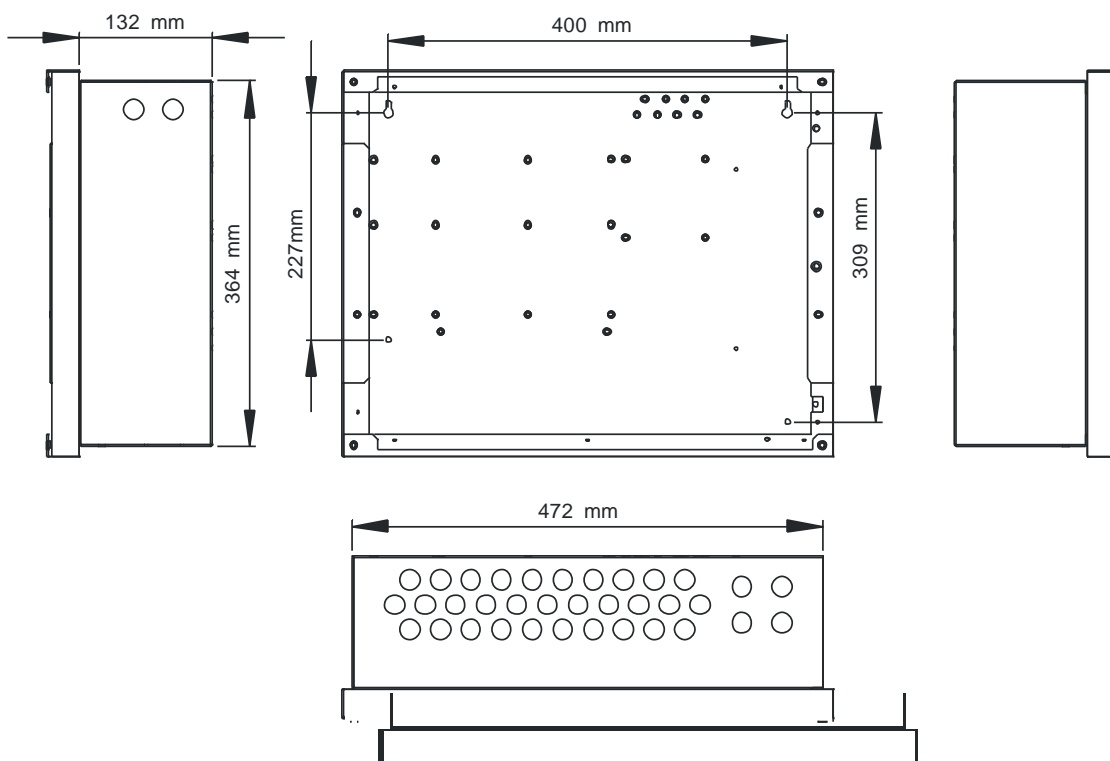

### 3.2 Earth cable on ULCF3000RM (does not apply to ULCF3000)

Care must be taken to ensure that the earth connection between the back box and the front cover of the on ULCF3000RM is connected each time the cover is removed and refitted. Ensure that there is a serrated washer fitted between the earth terminal and the nut on both ends of the cable.

Figure 7. Earth strap

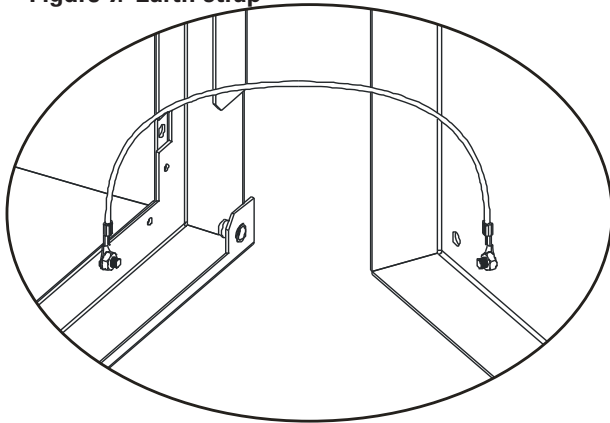

### 3.3 Installing cabling

Once the backbox is mounted the next stage is to install the power and loop cables and fit the glands.

### 3.4 Connecting the AC Power and earth connection

#### **⚠ WARNING**

**To reduce the risk of electrical shock, make sure that all power has been turned off or disconnected prior to attempting to connect power to the Power Supply.**

**Note:** Make sure that AC main circuit breaker is off before wiring any connection between mains and control panel

The primary power needed for the Menvier Fire Alarm Control Panel is 120VAC 60hz or 240VAC 60Hz.

1. 1.Enter Power Cable into Cabinet knock out hole.
2. 2.Attach the brown (live) wire from the source to terminal "Line" (USA use color black wire).
3. 3.Attach the blue (neutral) wire from the source to the "Neutral" terminal (USA use color white wire).
4. 4.Attach the ground wire from the source to the "GD" terminal block (USA use color green wire).

### Cable anchorage

The mains cable must be fixed securely with a 20mm cable gland. Remove a suitably located knockout feed the cable through the gland and bolt the gland to the ULCF3000 and ULCF3000RM backbox as shown. Secure the cable to the side of the box using the cable clip provided.

Connect wiring from AC mains to J2 on the PCBA2147 being careful to observe proper connections in the figure below.

**Note:** Apply the AC Power BEFORE connecting the batteries to the Panel!

**Note:** Apply AC power to panel after the system is completely installed and visually checked.

Figure 8. AC power entry

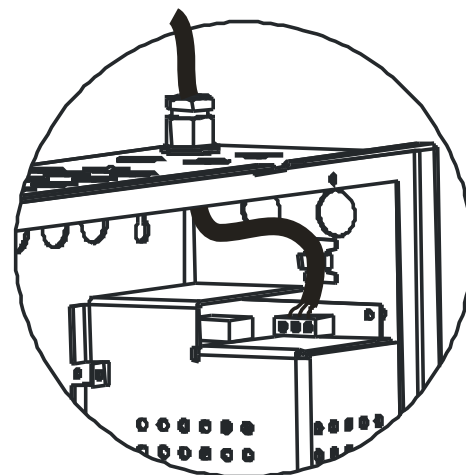
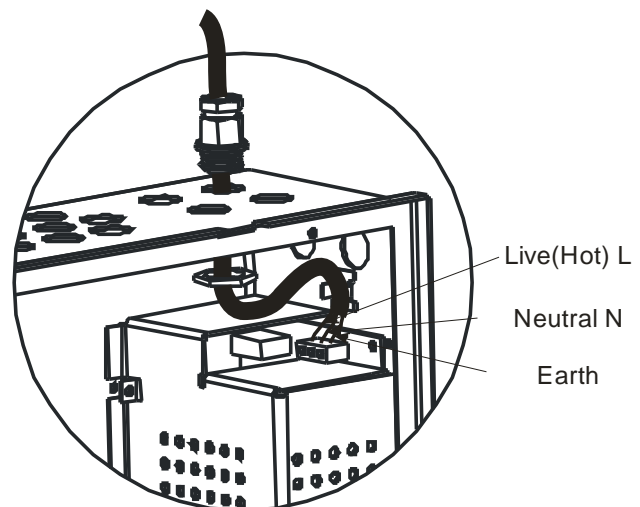

### 3 Installation

#### 3.5 Battery installation

The batteries are placed at the bottom of the enclosure by removing the four nuts holding the battery plate. The ULCF3000 is fully protected if the batteries are connected in the opposite direction the battery fault yellow led will show steady in such a condition. When green battery LED is in a steady condition to shows that the battery connection is normal.

Figure 9. Battery connection

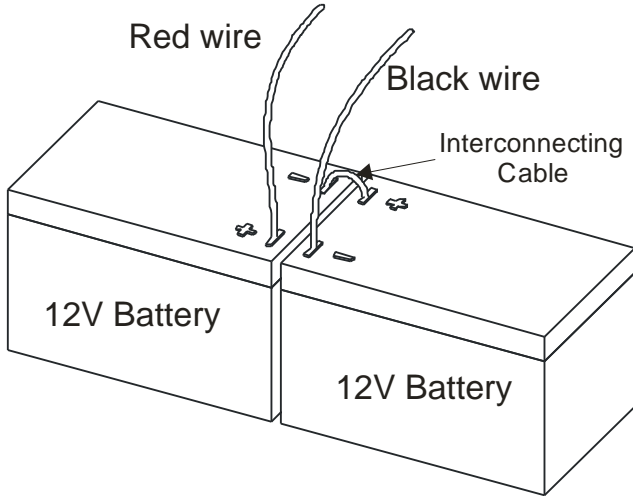

#### **⚠ WARNING**

Before connecting the battery to the fire alarm panel. Ensure the interconnecting cable between the batteries is not connected. Do not connect this cable until the system is fully installed.

#### 3.6 Output (NAC) installation

The Panel is equipped with 4 regulated Class B Style Y NAC (Notification Appliance Circuits). At 240Vac input, use 4 horns 0.75A each for 3A total. At 120Vac input, use 3 horns, 0.75A each for 2.25A total. At either 240Vac or 120Vac, use 2 NACS for strobe synchronisation using Wheelock DS 12/24 with 2 regulated outputs at 0.25A each or 0.5A total.

Use UL listed notification appliances only (see table 2). These appliances capable of producing the American National Standards Institute's ANSI S3.41 audible emergency evacuation signal pattern, and are synchronized on a system basis. These devices can be silenced system or globally.

#### 3.6.1 Class B Style Y NAC wiring using main board (Horns only)

Figure 10.

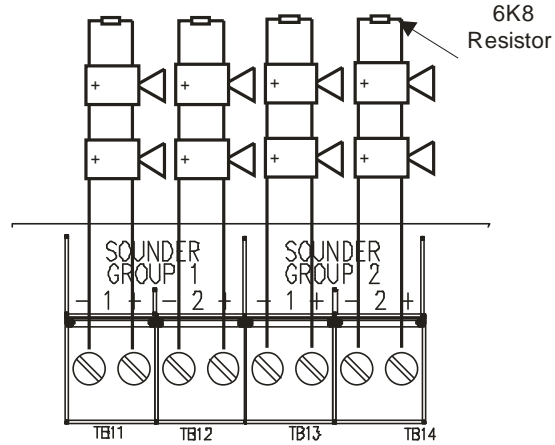

#### 3.6.2 Class B Style Y NAC Wiring using Wheelock DS 12/24 (Horns & Strobes)

Figure 11.

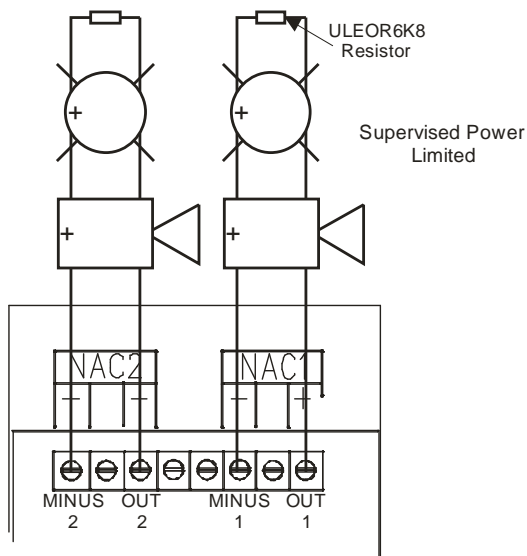

### 3.7 SLC Installation

Four SLC loop Class A Style 6 are provided on the Menvier Fire Alarm Panel main board. These SLC groups provide communication to addressable detectors, monitors, indication devices and control modules.

Figure 12. SLC Instillation

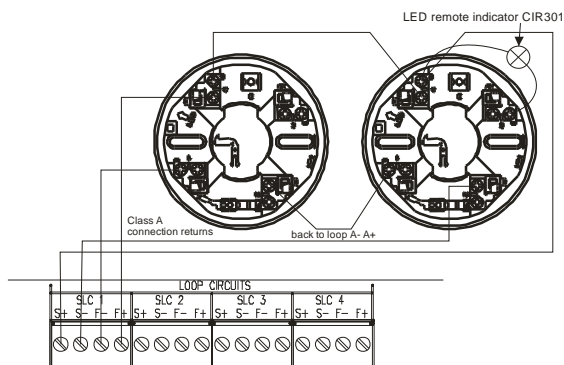

Maximum of 200 addressable devices per SLC circuit (see fig. 2)

### 3.8 Supervisory signal

Addressable devices can be programmed for supervisory signals. This input on a latching mode and requires a manual reset to restore their normal state provided the condition is cleared.

#### Panel relay outputs

The panel has 3 Form C relays 30V 1A (resistive) Alarm, Trouble, and AC Trouble.

The AC Trouble relay can be programmed as per NFPA 72 requirements.

These three out puts can be used to connect to a central station using Firewatch 411UD Digital Alarm Communicator Transmitter.

#### Technical specifications

Contact rating

Figure 13. Panel relay outputs

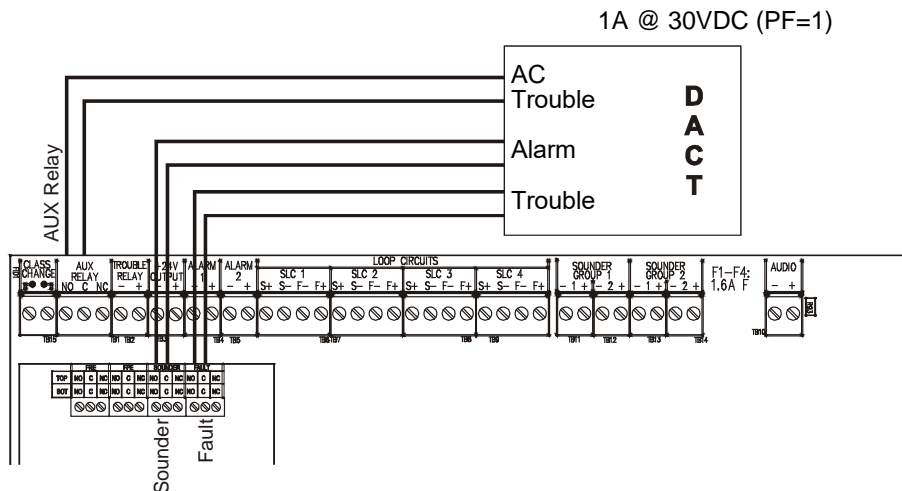

## 4 Networking

### 4 Networking

This operation is only UL approved while connected in the same enclosure (rack) since the Network Card cannot detect Ground Faults.

Only the Network Repeater while in passive mode and only able to silence it's own audible device (piezo buzzer) may be networked.

Up to 126 ULCF3000 and ULCF3000RM panels or passive repeaters can be networked together to operate as a single networked system. To achieve this each panel must be fitted with a network card (supplied at additional cost.)

When operating as a networked system all fire and fault event information is displayed at every panel, silencing and resetting of alarms can also be carried out from any panel on a networked system if panels are suitably configured.

Networked panels are connected using a loop topology as illustrated.

Networked panels can be used as active repeaters; alternatively a low cost passive repeater is available.

This can either be connected in a loop of an individual panel or it can be connected to the network.

The recommended network cable for the network connection between panels is an enhanced Firetuf cable Manufactured by Draka cables (part number 910234.)

Screen continuity must be maintained throughout the entire network circuit including at each junction point. The screen should only be earthed at the connection point provided at the first panel and not at any other point. The screen or drain wire of the network cable should not be considered as a safety earth and therefore should not be connected to terminals marked with the earth symbol, except at the panel, and should not be insulated with green and yellow sleeving

Where the network cable passes between buildings, screen continuity should not be maintained from building to building. A booster device must however be used irrespective of cable length and should be fitted at a suitable point in the link between buildings. The cable screen should be connected to the earth of one panel in each building.

Figure 14. Network example

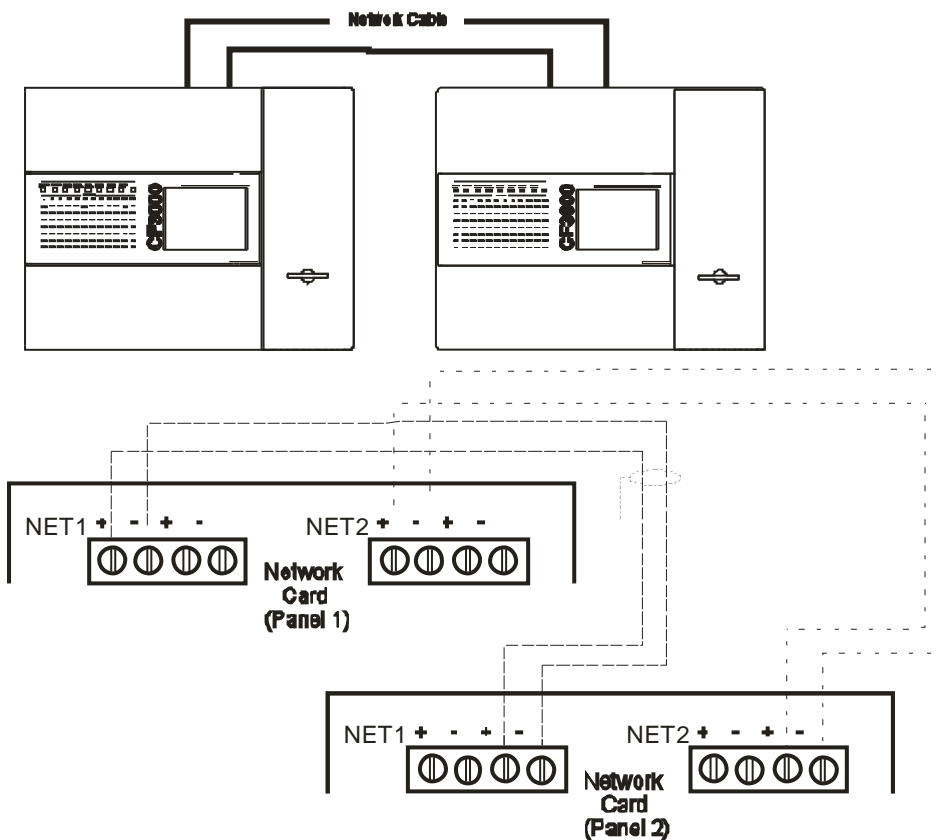



## 4.1 Battery maintenance installation cautions

### Initial preparation before installation:-

Verify no abnormalities on battery case (like crack or leakage)

Free air space must be provided between each battery. Recommended minimum space is 5~10mm (0.02~0.04 inches).

Set the batteries firmly in the equipment. Otherwise, batteries may be damaged, or connection conductivity may be decreased due to shock. When batteries are used in vibration conditions, they shall be mounted in upright position and with proper cushion for protecting vibration.

Avoid mixed usage of batteries differing in capacity, manufacturer, storage or charge/discharge conditions. Batteries may be damaged after cycles due to difference in electrical characteristics.

### Regular check and replace precautions

Measure the total voltage of the batteries during float charge to see whether there is any abnormal deviation and investigate the situation.

#### TRANSPORTATION PRECAUTIONS

Handle the batteries carefully to avoid injuries. Avoid moisture or rain on the batteries and cartons. Transport the batteries in the upright position and avoid abnormally strong shock / vibration.

Do not lift a battery by its terminal. Otherwise, internal construction may be damaged and leakage may occur.

### Other precautions

Clean battery with wet soft cloth. Never apply oil, polyvinyl chloride or organic solvents (like gasoline and paint thinner) to the battery. Otherwise, battery cover may be cracked / deform and acid leakage will result.

Do not disassemble the battery. Otherwise, sulphuric acid will flow out.

If sulphuric acid deposit on to skin or cloth, wash immediately with water. If splashed into eyes, wash with a large amount of water and consult medical physician immediately.

Avoid dusting by cloth duster or dry cloth (particularly chemical textile), as they will generate static electricity which is dangerous.

Wash your hands after handling battery.

Do not short the battery terminals.

Never dispose battery into fire.

## 5 Technical specification

### Power Supply (Approved UL 864 9th Edition) Mains

Nominal Voltage	: 120 Vac		
Nominal Current	: 240 Vac		
Maximum Current	: 75mA		
Input Fuse R1	: 1.5A		
	: NTC SG39 I <sub>max</sub> 4Amp		
Output Voltage including tolerances	: 26V	= 18.5 to 29.5Volts	
	: 26V RAW	= 18.5 to 29.5Volts	
	: 5Volt Output	= 4.6V to 5.5V	
Ripple Voltages	26V	= 800mV	
	26V RAW	= 800mV	
	5Volt Output	= 430mV	
Maximum Loadings	26V O/P	= 0.98A	I max b
	26V RAW O/P	= 1.7A	I max b
	5V	= 0.5A	
Standby Current (4 Loops Loaded)	: 26V	= 280mA	I max a
	: 26V RAW	= 150mA	I max a
	: 26V	= 280mA	I max
	: 26V RAW	= 150mA	I max
	: 5V	= 43mA	

ULCF3000 and ULCF3000RM is protected by an internal thermal device, this requires no maintenance.

I max a, I max b & I min = Current as specified in UL 864 9th Edition

### Batteries

Number of Batteries	: 2
Manufacturer:	: YUASA NP12-12
Capacity	: 12 Ah
Battery Fuse	: 6.3A Anti-Surge (F4)
Maximum battery current	: 3.5 Amps
Standby current (mA)	: 175 (4 loops), 125 (2 loops)
Maximum Charging Current to the Batteries	: 0.970amp
Float Voltage	: 27.4 Volts
Final Voltage	: 20.4Volts
Charging Characteristics	: Constant Voltage with 0.970A limit with temperature Compensation
Maximum current drawn from the batteries when the mains is not available	: 3.5Amps
Deep Discharge Protection	: 20.6 Volts
Battery Internal Impedance Fault	: >0.5 ohms

## CAUTION

Risk of explosion if battery is replaced by an incorrect type. Dispose of the used batteries according to the instructions.

## 5 Technical specification

### Outputs

#### NAC circuits

Number of sounder circuits	: 4
Total sounder Load	: 0.75 Amp max per sounder or 1.5 Amp max per sounder with Wheelock DSM 12/24 (2 circuits)
Sounder Circuit Fuses (F1/2/3/4)	: 1.6 Amp (Quick Blow)
End of line resistor	: ULEOLR6K8

#### AC Trouble, alarm trouble, trouble outputs

The auxiliary relays provide fused volt free change over contacts. These contacts are not monitored.

Max Load	: 30 Volts 1 Amp Resistive
AC Trouble Relay: Fused (PTC)	: 1.1 Amp

#### Printer (Optional)

Type	: High speed thermal
Number of Characters per Line	: 40
Type of paper	: 58mm x 46mm Thermal Roll
Replacement paper roll order code	: ADF6PRINTERPAPER

#### Mechanical specification

Weight including batteries	: 18Kg
Weight excluding batteries	: 9Kg
Dimensions (Standard batteries)	: 495mm(L) x 395mm(H) x 180mm(D)
Type of Material (backbox)	: Mild Steel (Power Coated)
Type of Material (Fascia)	: PC/ABS
Flammability Rating	: UL 94 5VA
Total Number of knockouts	: 51
Diameter of Knock out	: 20mm
Anti-Tamper Cover ( Optional)	
Material used	: Poly Carbonate
Flammability Rating	: UL 94 5VA

Terminal blocks: do not use excessive force when tightening the screws.

## 6 Commissioning

Before connecting and powering up the panel please ensure you read and understand the manual.

The following is a summary of the minimum steps to start the Menvier ULCF3000 Fire Alarm Panel.

1. Read Manual
2. Ensure all cables are fault free (no ground, Open or short circuit faults) and follow the procedure below.

**Figure 15. Commissioning procedure**

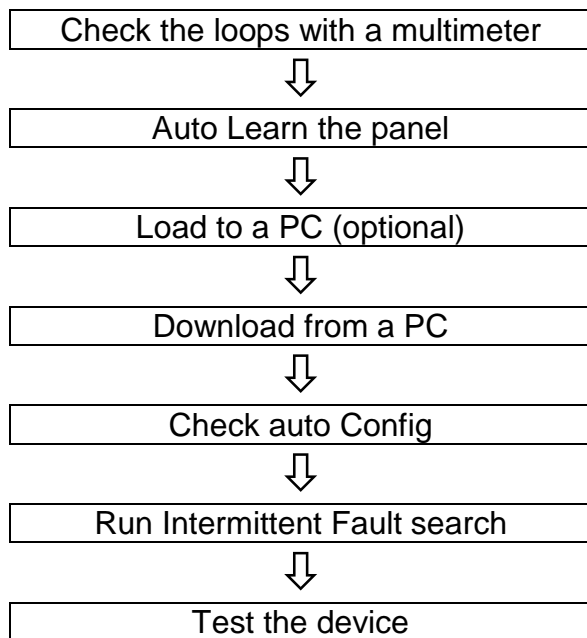

### Loop checking with a multimeter

The first quick test that should be done on all the loops is to check the continuity of the loops using a multimeter.

The resistance should be measured start positive to end positive, start negative to end negative, and positive to negative at the start and end of each loop.

The resistance along the positive line should be less than 50 ohms. The resistance across the negative line should be 2k5 ohms for each device on the loop, e.g. 20 devices should measure 50k ohms.

The resistance across the loop positive to negative will be in the Mohm region.

Ensure the screen is continuous around the loop; this reading should be approx 10 ohms.

The screen should not be bonded to building earth.

Test the loops with the multimeter set to AC volts – this is to check that there is no induced voltage which could be caused by the cables being run too closely to a high voltage source.

This will show if anything drastic is wrong with the loop devices wired in backwards breaks etc. If there is a short at the end or start of the loop this will need to be fixed before powering the panel.

### Auto-learn function (see page 46)

This is accessed through the engineer level access code. When the panel is auto-learned all the devices address information is set up from address 1 upwards from the start of each loop, previous addressing is lost. Once the panel has finished the auto-learn it will reset itself. After this is done reset the panel using the touch screen.

### Check auto config.

This function has two purposes, the first is to check that when a database has been downloaded the transmitted data matches the device data on the loop and then it highlights any anomalies as device unknown or device type mismatches.

The second is to pinpoint any o/c or s/c faults on the loop. The panel achieves this by electronically disconnecting the return legs and interrogates the devices on the loop. If there is a break the panel will go to fault stating the first device it cannot see beyond the break. This same function also pinpoints short circuits in the same way, creating a fault beyond the point where an isolator has opened.

## 6 Commissioning

### 6.1 Configuration

#### Detector LED flashing

The ULCF3000 and ULCF3000RM detector flashing function is used to allow a visual inspection and confirmation that the fire panel is in communication with the installed system devices. This facility can be accessed via the engineering menu and can be switched on or off at any time as required.

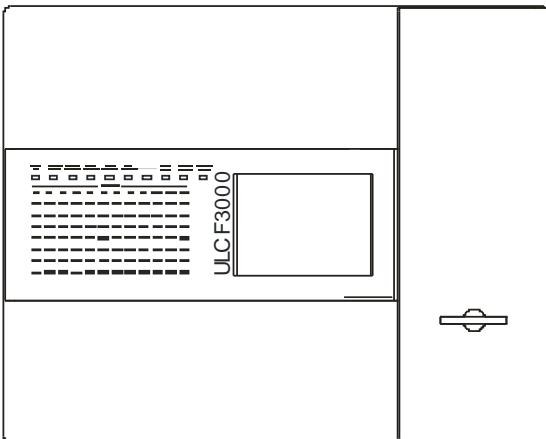

#### Up/downloading using PC software (see page 45)

The PC Software enables the panel to upload all the address, location text, any comments and programming of inputs and outputs to be downloaded back to panel. This will speed up commissioning.

### 6.2 Panel programming

#### Positive alarm sequence

The positive alarm sequence will program a delay to the NAC's, Alarm relay and Auxiliary for a period of 15 seconds, if the alarm is acknowledge, it will silence the piezo sounder and start a timer which prevents activation of these outputs for an additional time duration which can be user programmed for up three minutes. After the programmed delay, all the outputs will activate if the source of the alarm is not cleared. If the alarm is not acknowledged or reset during the first time delay of 15 seconds, all the appropriate outputs will be activated.

Note: If a second alarm occurs during either time delays, the alarm will proceed immediately causing activation of the appropriate output zones.

Pre-signal: An arrangement where the operation of an automatic detector or initial operation of manual station actuates only on selected devices or devices for the

purpose of notifying key personnel who then have the option of initiating a general alarm. All NAC's circuits, and Auxiliary outputs can be pre-programmed with a delay of up to 10 minutes using Menvier Site Installer software by using a double knock global or zone feature.

During this condition, the Pre-signal will be lit.

#### Alarm verification features

The panel is equipped with the Alarm verification features used to reduce unwanted false alarm wherein a typical smoke detector report alarm condition for minimum period of time in order to accept a valid alarm condition. This period can be programmed to 15s, 30s or 60s.

During the minimum 60-second alarm confirmation period following the retard-reset-restart period, re-actuation of the same detector that initiated the alarm verification cycle, actuation of another smoke detector on the same circuit (zone), or an alarm from another zone shall result immediately in an alarm signal from the control unit.

Figure 16. Alarm verification timing diagram

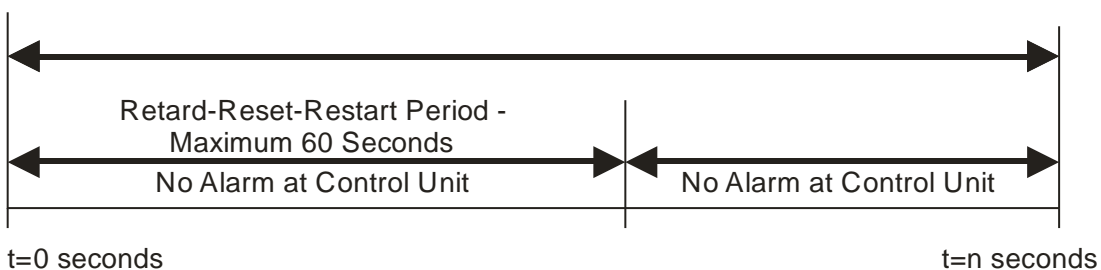

## 6.3 PC Commissioning Software

### 6.3.1 Device input programming

Normal Standby	⇒	Default setting
Alarm	⇒	Panel reports fire from device.
Trouble	⇒	Panel reports fire from device.
Reset	⇒	Panel resets.
NAC Silence	⇒	Silence all currently active sounders.
Supervisory	⇒	Panel reports supervisory from device.
Drill	⇒	Panel manually set into alarm.

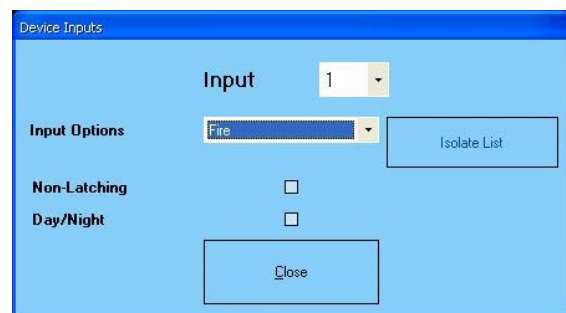

### NAC Programming

#### Pre-Signal

The output of a device when triggered can be delayed up to 10minutes - based on a user defined value in minutes.

This programming option is enabled when a value other than zero is entered inside the 'Delay' window.

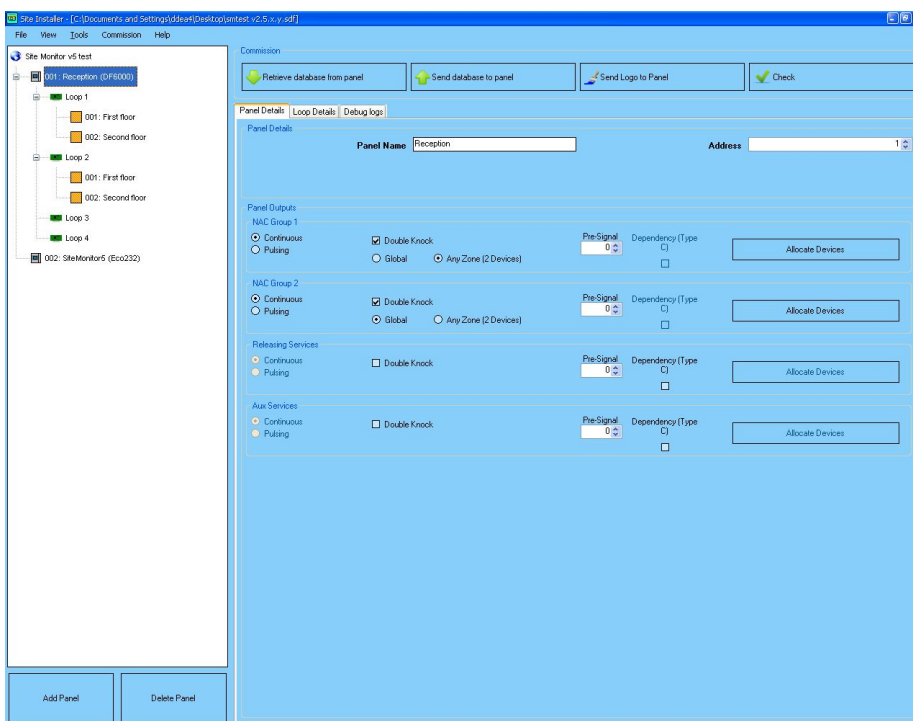

Every panel must be configured with the pre-programmed delay Double Knock per Zone is required for outputs to operate pre signal.

Double Knock feature will override:

- Pre programmed delays
- Alarm Verification
- Positive Alarm Sequencing

## 7 Panel controls & indicators

### 7.1 Touch screen display

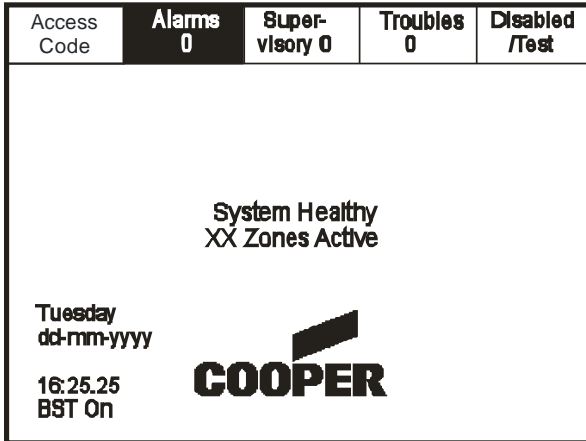

The Touch Screen is a multi-function display consisting 320x240 dots featuring high intensity backlighting. In normal operation, the display indicates as above with the backlighting off.

During an event on the system the display shows the FIRST EVENT and LAST EVENT plus other events as space allows.

The last 2 lines are normally used to display the total number of events, but they are also used for scrolling fire conditions, faults, pre alarms or disabled devices independently or for displaying a reduced menu when in fire condition.

When an event occurs the Touch Screen backlighting comes on unless there is a mains power supply fault.

Use the Touch Screen to scroll through all active events on the system by using the SCROLL UP and SCROLL DOWN buttons (available at access level)

1. You can display the contents of the log and also view details of any Alarms, Troubles, pre-alarms, faults or disablements. When displaying the system menu on the Touch Screen, the last 5 lines of the display are shown in reverse text.

### 7.2 Panel operation

ULCF3000 and ULCF3000RM are operated via a backlit touch screen. The default fire screen is shown below. From this screen all the panels' functions can be operated. The first time you touch the screen the backlight will illuminate the panel.

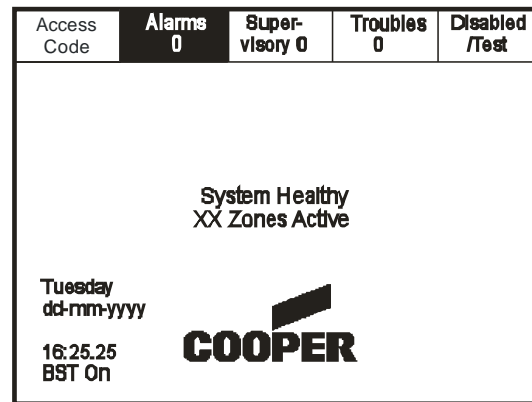

Pressing a field will highlight it and forward to the next screen as shown below.

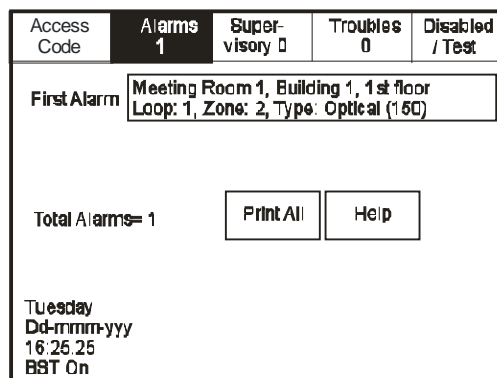
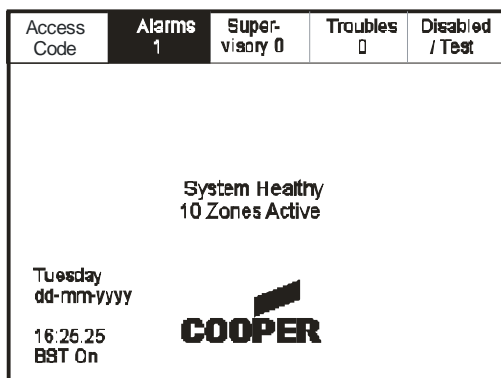

### 7.3 Public access level 1

Public access level does not require an access code and allows anybody to review the functions outlined below

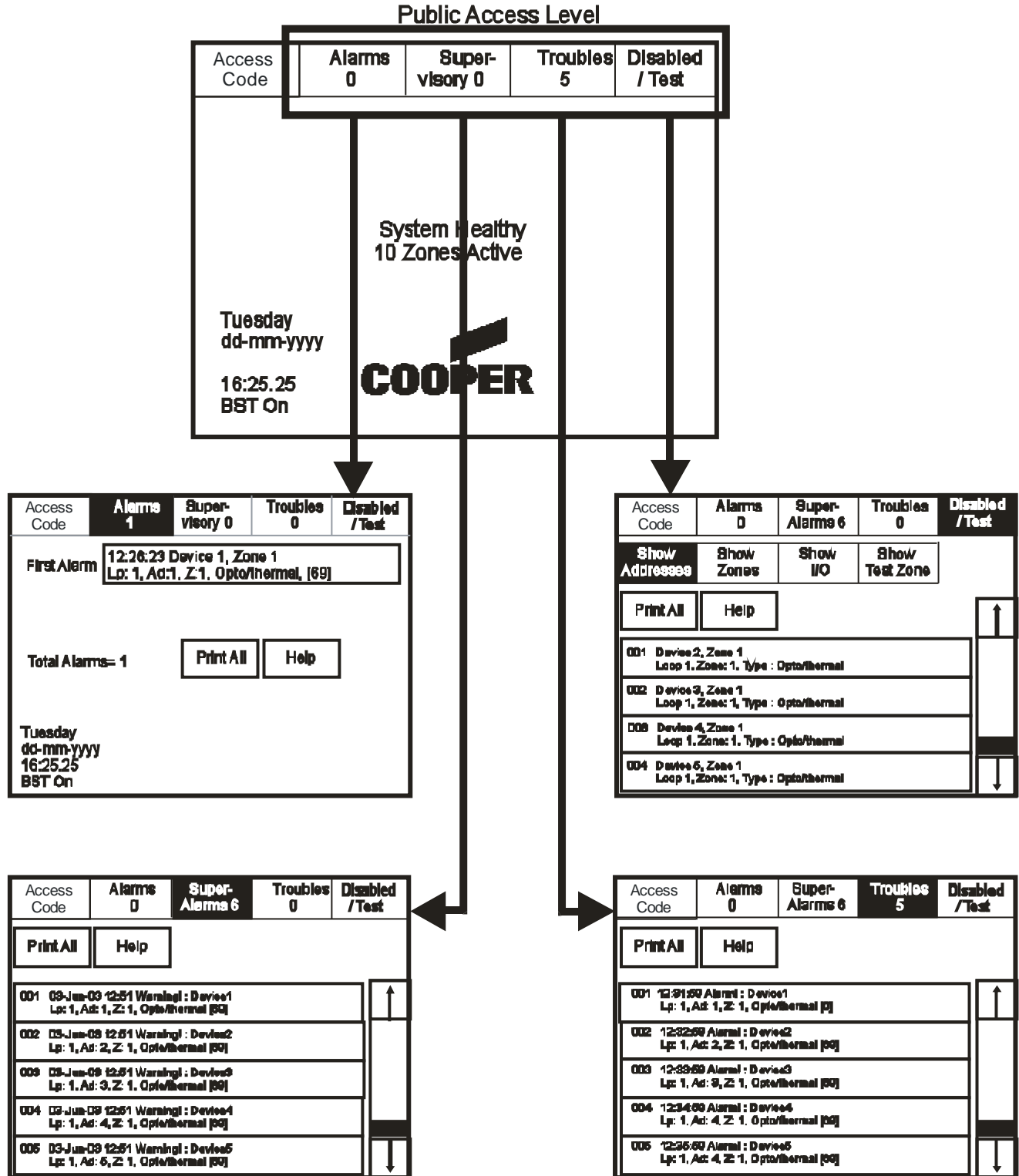

## 7 Panel controls & indicators

### 7.4 Evacuate (Access level 2)

To activate the touch screen, touch the top left corner of the screen until the screen illuminates. To enter the supervisor mode touch the supervisor button and enter the passcode.

Enter the Supervisor Mode Passcode and select "Evacuate" on the menu at the top of the screen.

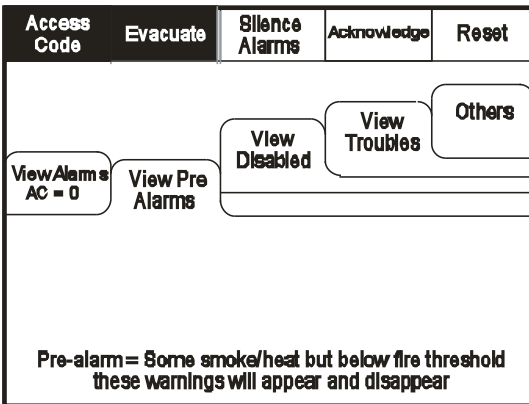

Select "Yes" to evacuate the building.

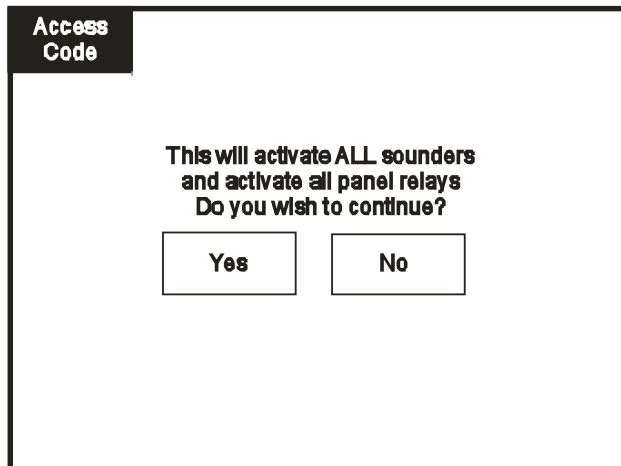

### 7.5 Silence alarms

To activate the touch screen, touch the top left corner of the screen until the screen illuminates. To enter the supervisor mode touch the supervisor button and enter the passcode.

Enter the Supervisor Mode Passcode and select "Silence Alarms" button as the top of the screen.

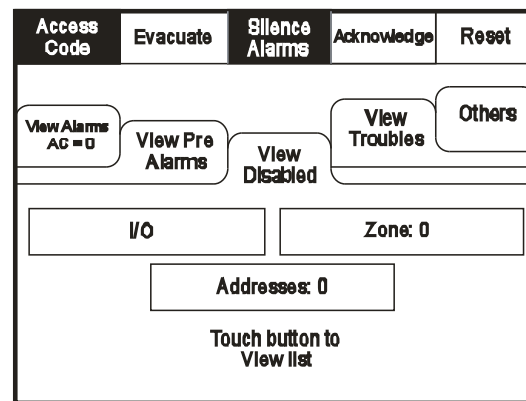

Select "yes" to silence Alarm.

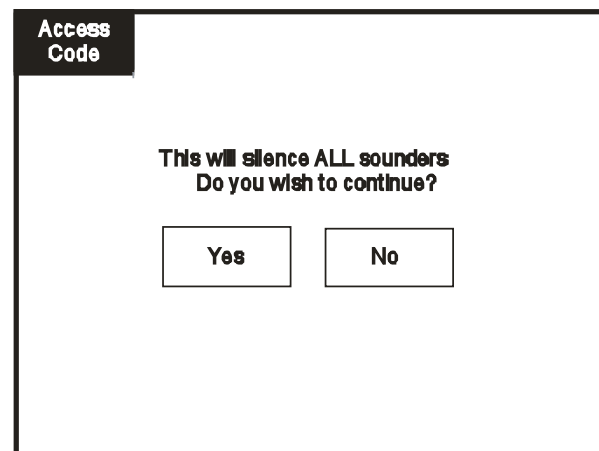



### 7.6 Acknowledge

To activate the touch screen, touch the top left corner of the screen until the screen illuminates. To enter the supervisor mode touch the supervisor button and enter the passcode.

Enter the Supervisor Mode and Select "acknowledge" from the Top Menu.

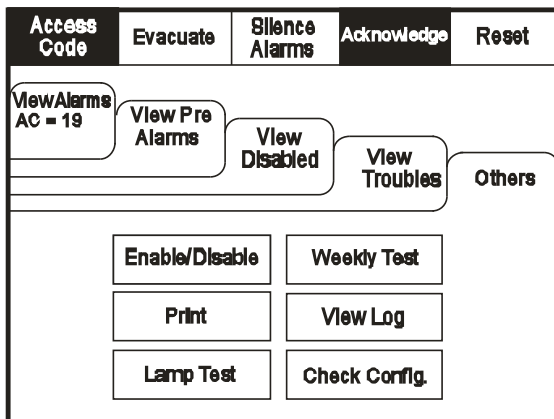

### 7.7 Reset

Enter the Supervisor Mode and Select "Reset" from the top Menu. Select "Yes" to reset the panel.

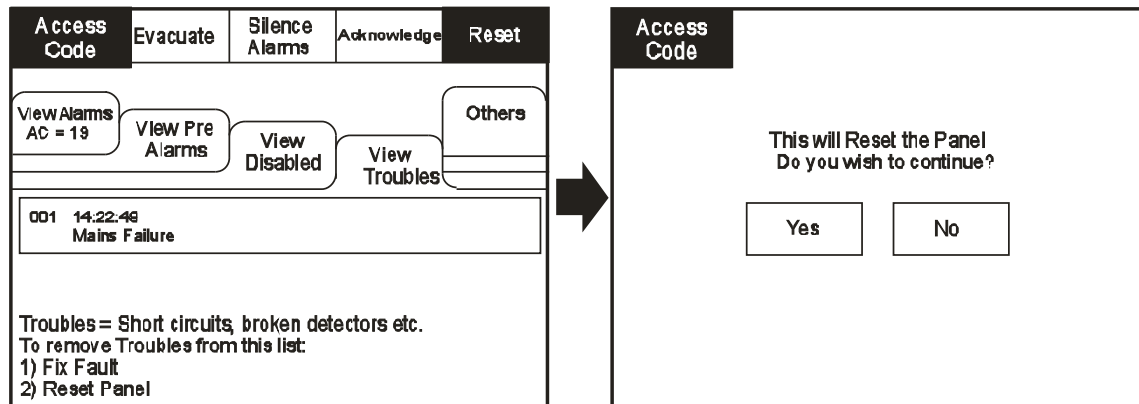

## 7 Panel controls & indicators

### 7.8 Pre-alarms

Enter the Supervisor Mode and Select "Pre-Alarms" tab.

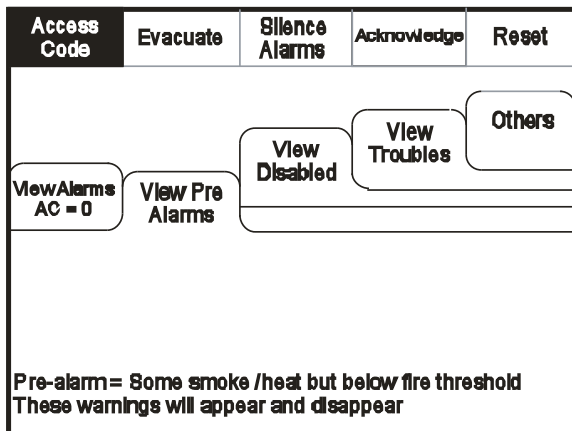

A pre-alarm is shown when a detector appears to register heat or smoke but in a quantity that is insufficient to warrant an alarm.

Pre-alarm may indicate a buildup of dirt in a smoke detector which can be interpreted by the detector as smoke presence.

### 7.9 Disabled devices

Enter the Supervisor mode and Select the "Disabled" tab.

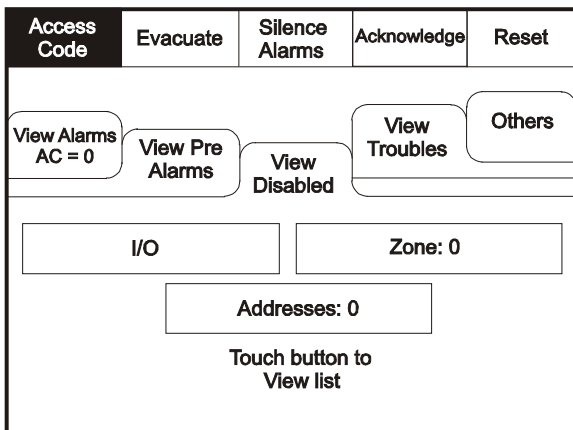

The individual buttons show which devices and the number of devices which have been disabled. Press one of the buttons to display detailed information for a particular category.

### 7.10 Troubles

Enter Supervisor Mode Passcode and select "Troubles" tab

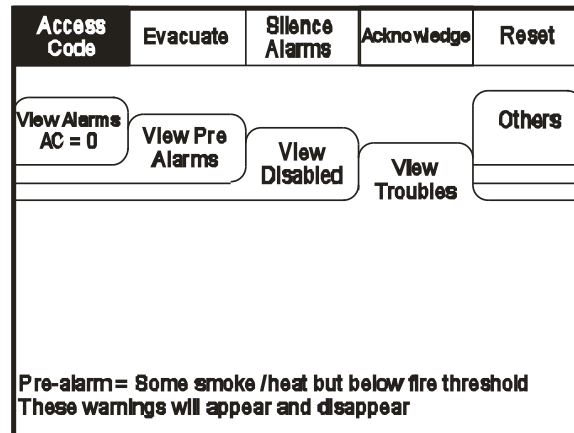

### 7.11 Enable/disable (Others menu)

To activate the touch screen, touch the top left corner of the screen until the screen illuminates. To enter the supervisor mode touch the supervisor button and enter the passcode.

Enter the Supervisor Mode passcode and select the "Others" tab.

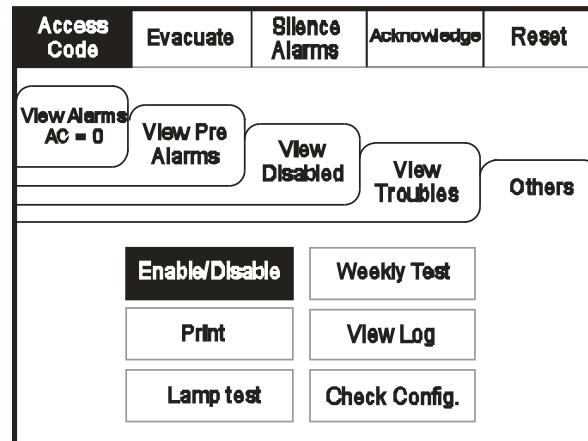

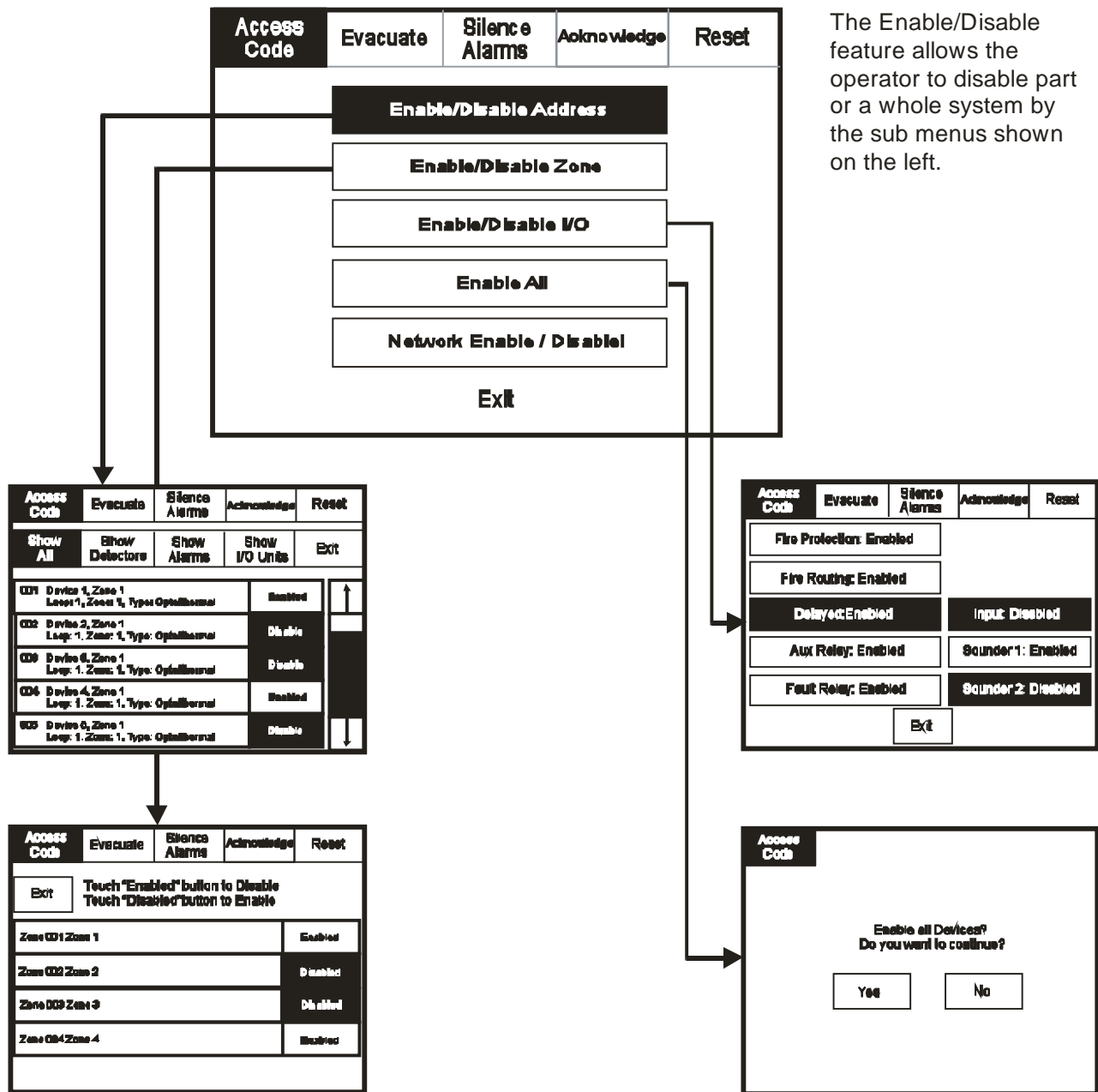

The "Disable All" feature is not permitted in UL864 9th Edition

## 7 Panel controls & indicators

### 7.12 Print

To activate the touch screen, touch the top left corner of the screen until the screen illuminates. To enter the supervisor mode touch the supervisor button and enter the passcode.

Enter the Supervisor Mode and Select the "Others" Tab. Press "Print"

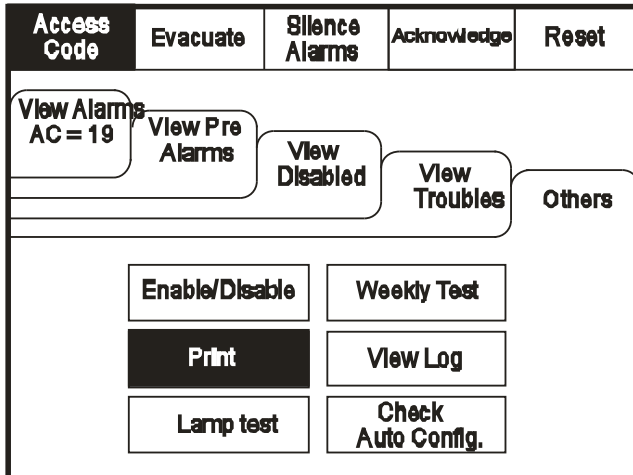

### 7.13 Lamp test

To activate the touch screen, touch the top left corner of the screen until the screen illuminates. To enter the supervisor mode touch the supervisor button and enter the passcode.

Enter the Supervisor Mode and Select the "Others" Tab. Press "Lamp Test"

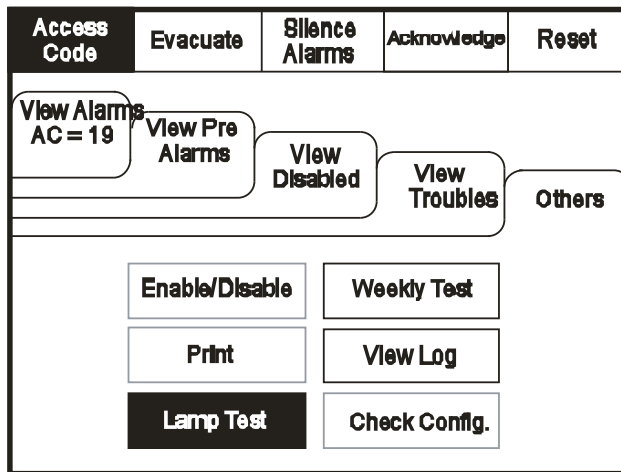

Select the Information you wish to print from the Buttons Listed

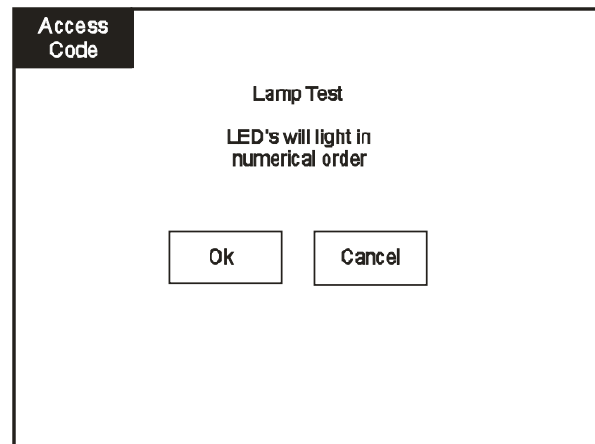
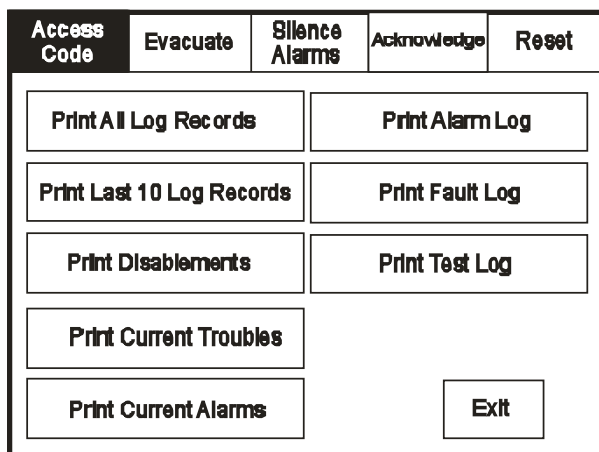

### 7.14 Weekly test

To activate the touch screen, touch the top left corner of the screen until the screen illuminates. To enter the supervisor mode touch the supervisor button and enter the passcode. Select the others tab as shown below. Press Weekly test.

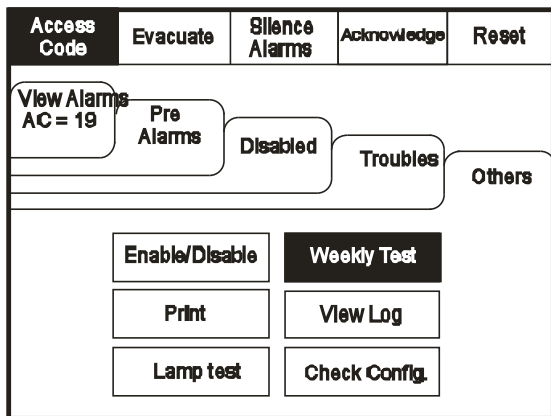

Weekly test is now in progress.

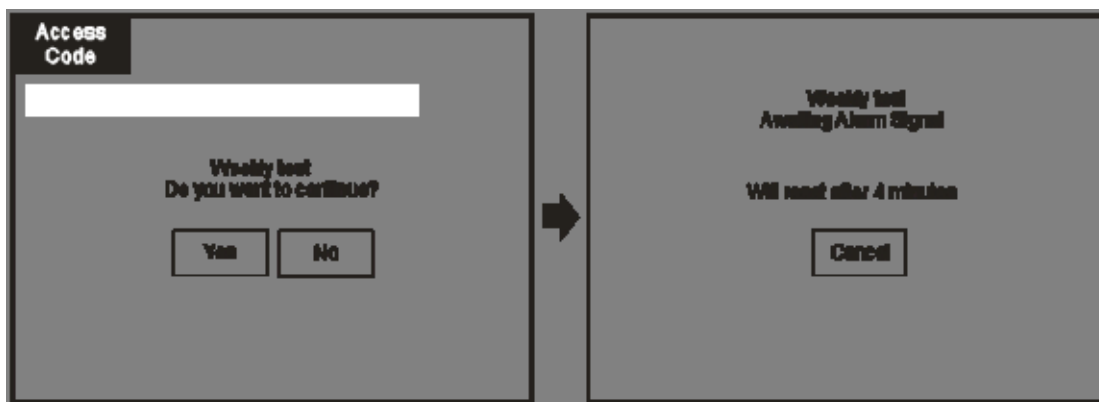

The panel will automatically return to the system healthy screen once the weekly test has been completed.

## 7 Panel controls & indicators

### 7.15 Viewing events

To activate the touch screen, touch the top left corner of the screen until the screen illuminates. To enter the supervisor mode touch the supervisor button and enter the passcode.

Enter the Supervisor Mode Passcode. Select the "Others" tab and press View Log.

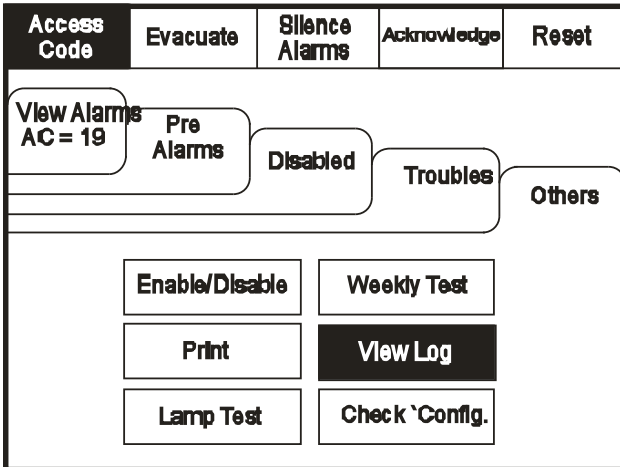

Use the scroll bar to view the list of up to 9999 events

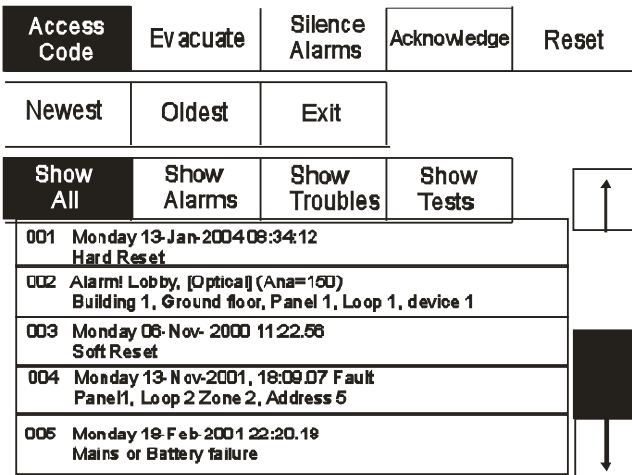

The ULCF3000 and ULCF3000RM event log stores up to 9999 events including, Alarms, Troubles, resets and address changes. Once the maximum 9999 events have been reached ULCF3000 and ULCF3000RM will automatically overwrite the oldest event every time a new event is stored. The event log can only be reset by an approved service engineer.

### 7.16 Check auto config

To activate the touch screen, touch the top left corner of the screen until the screen illuminates. To enter the supervisor mode touch the supervisor button and enter the passcode.

Tab. Press Check Auto Config. This feature will scan the loop and pinpoint the exact location of any break in the loop wiring and will also identify any changes in the loop configuration (e.g. New devices added or changed device types).

Enter the Supervisor Mode and Select the "Others"

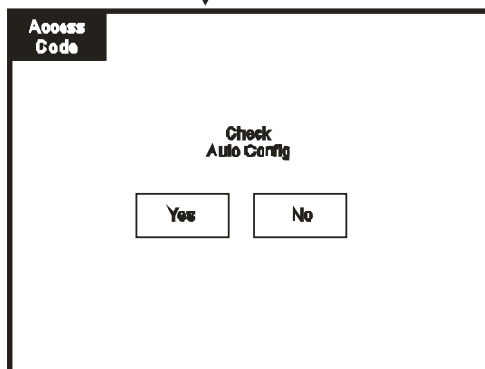
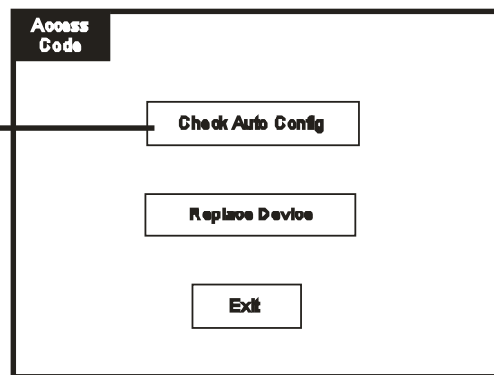
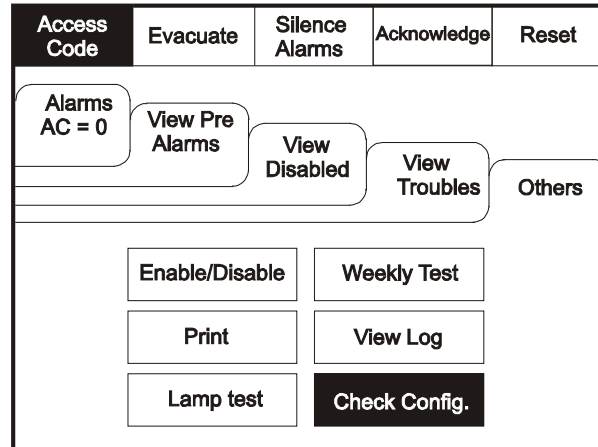

Press the Supervisor Mode button at the top left of the screen.

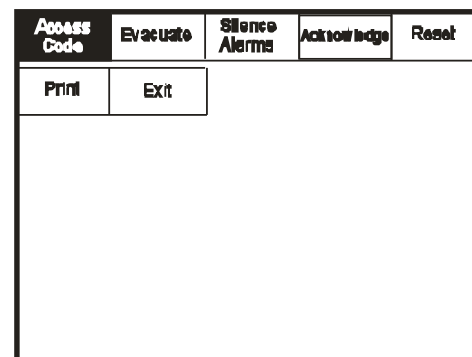

## 7 Panel controls & indicators

Replace device enables an existing device to be replaced with a new device without losing the existing text and sounder programming.

Replace a single device then use the replace device menu to allocate an existing address to the new device.

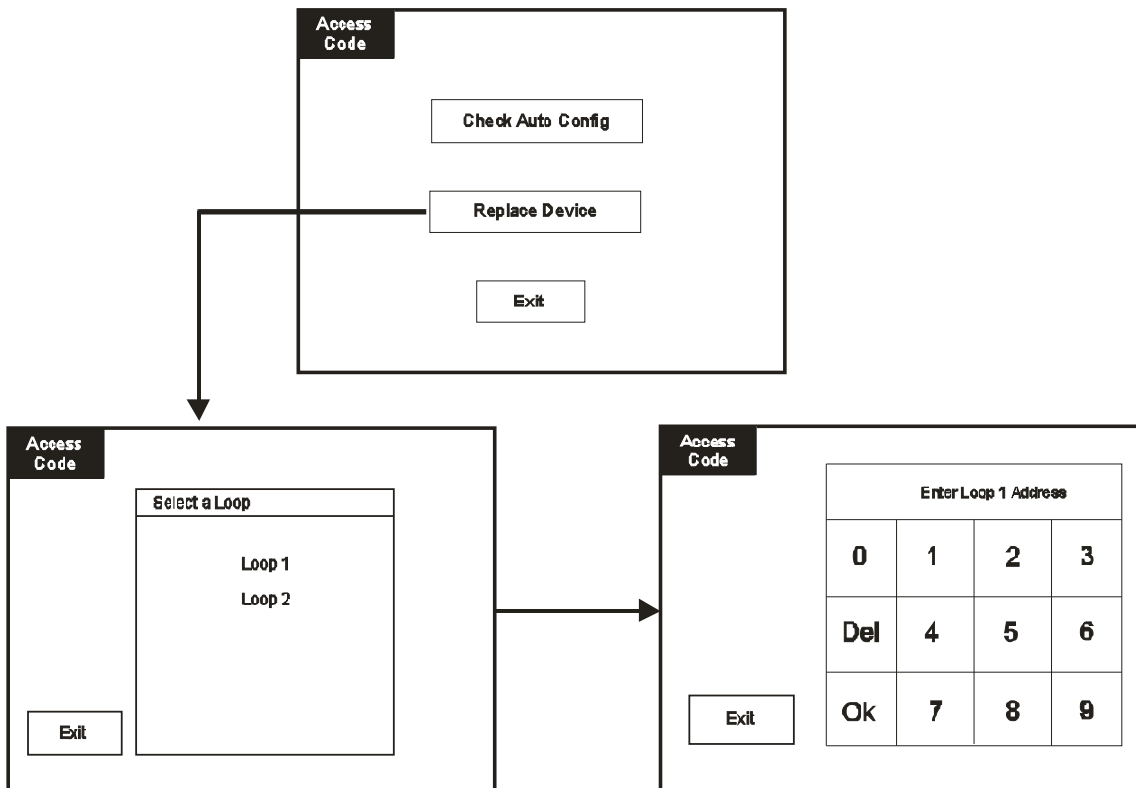
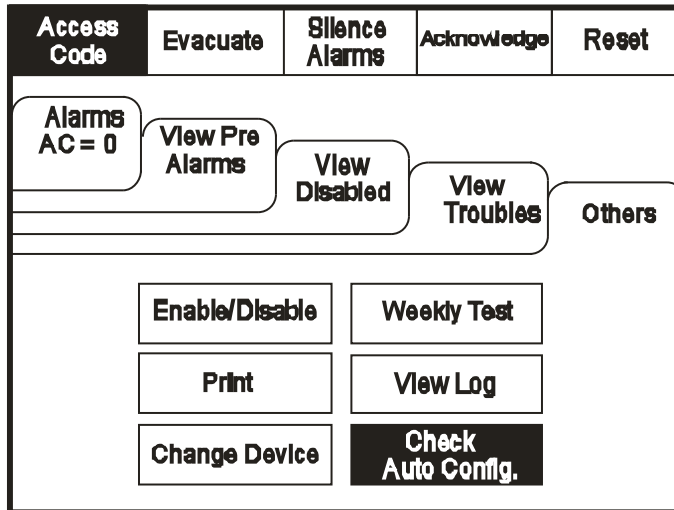



### 7.17 Test device (Access level 3)

To activate the touch screen, touch the top left corner of the screen until the screen illuminates. To enter the service mode touch the supervisor button and enter supervisor passcode.

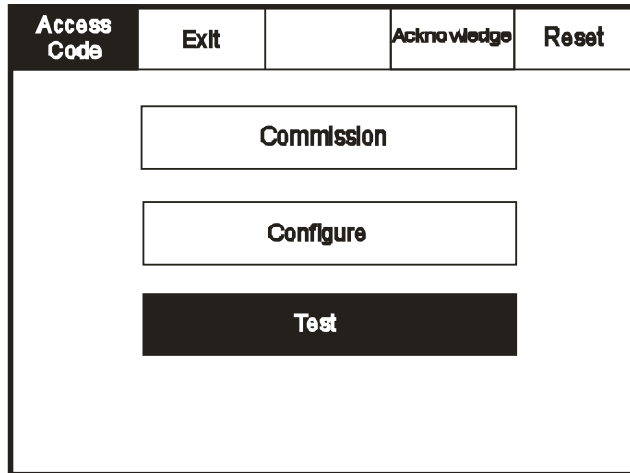

Enter the Service mode. Select "Test".

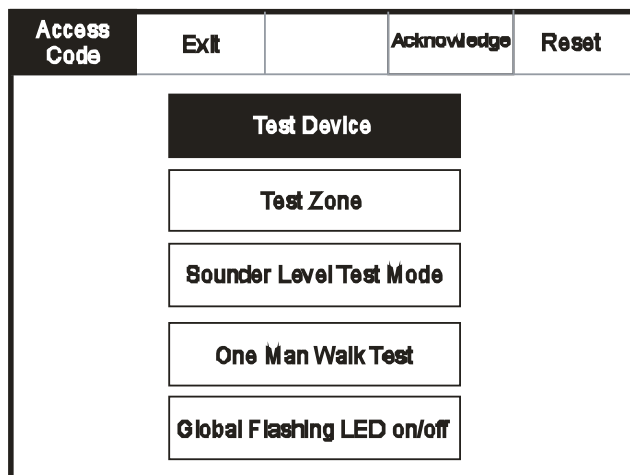

Select the "Test Device" button.

Touch row to select device to test.

<b>Service</b>			<b>Exit</b>	<b>Reset</b>
<b>FRE Off</b>				
Touch row to test				
<b>Show All</b>	<b>Show Detectors</b>	<b>Show Alarms</b>	<b>Show Relay</b>	
001	Lobby, Bldg 1, 1st floor Loop: 1, Zone: 2, Type: Optical			↑
002	Mail Reception, Building 1, 1st floor Loop: 1, Zone: 2, Type: Optical			
003	Storage/Archive, Building 1, 1st floor Loop: 1, Zone: 2, Type: Optical			
004	Meeting Room 1, Building 1, 1st floor Loop: 1, Zone: 2, Type: Optical			↓

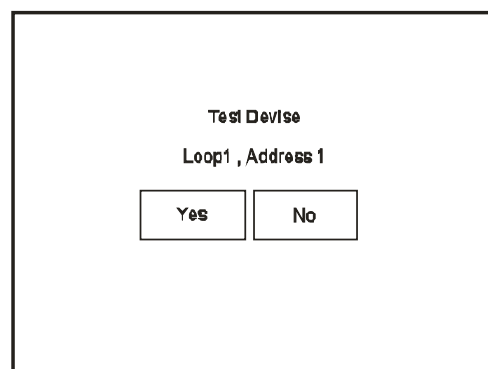

## 7 Panel controls & indicators

### 7.18 Test zone

To activate the touch screen, touch the top left corner of the screen until the screen illuminates. To enter the supervisor mode touch the supervisor button and enter the service passcode.

Enter the Service Mode, Select "Test" and on the Screen Shown Below Press "Test Zone"

Access Code	Exit	Acknowledge	Reset
<b>Test Device</b>			
<b>Test Zone</b>			
<b>Sounder Level Test Mode</b>			
<b>Global Flashing LED on/off</b>			
<b>One Man Walk Test</b>			

Access Code	Exit	Reset
Touch "-" Button to place a zone into test mode Touch "+" Button to remove a zone from test mode		
Zone 001 Building 1, Ground	-	↑
Zone 002 Building 1, 1st floor	Test	
Zone 003 Building 1, 2nd floor	-	
Zone 004 Parking & Stores	-	
Zone 005 Building 2, basement	-	↓

### 7.19 Sounder level test mode

Enter the Service Mode and Select Test. From the Test Menu Select "Sounder Level Test Mode"

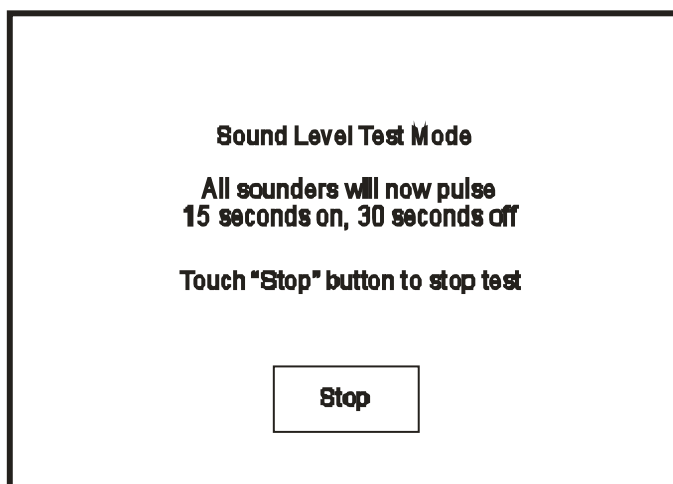
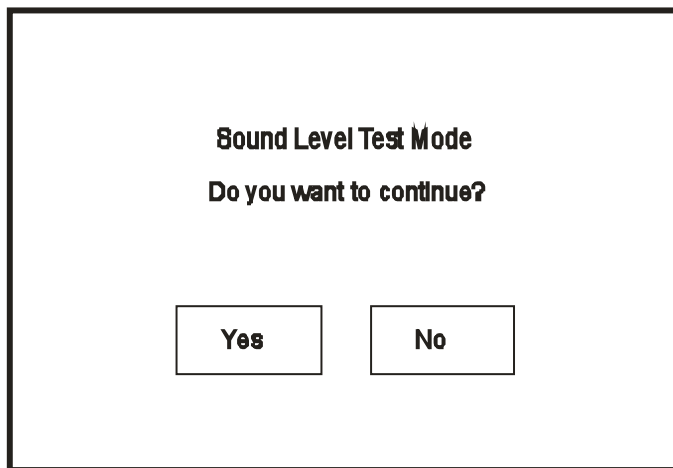
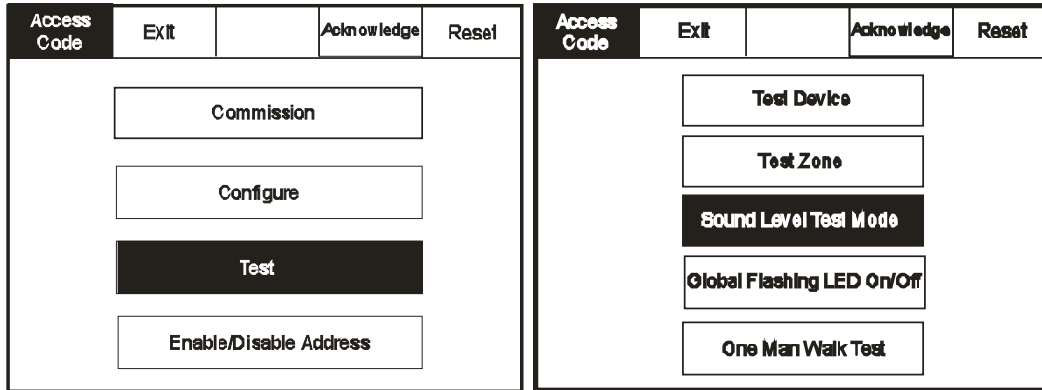

## 7 Panel controls & indicators

### 7.20 Global flashing LED on/off

To activate the touch screen, touch the top left corner of the screen until the screen illuminates. To enter the supervisor mode touch the supervisor button and enter the service passcode.

Enter the Service Mode and Select test.

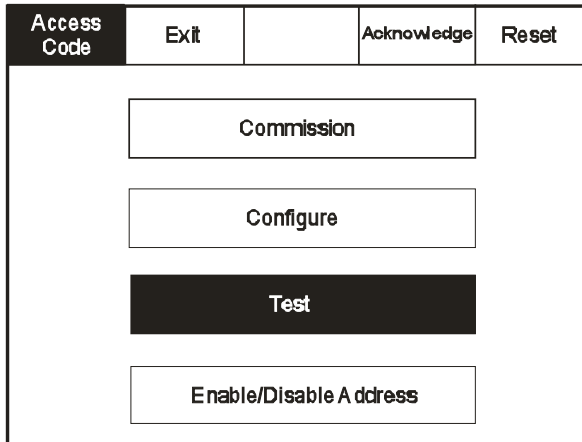

If global LED flashing is set to on, all device LED's will pulse intermittently to confirm correct communication.

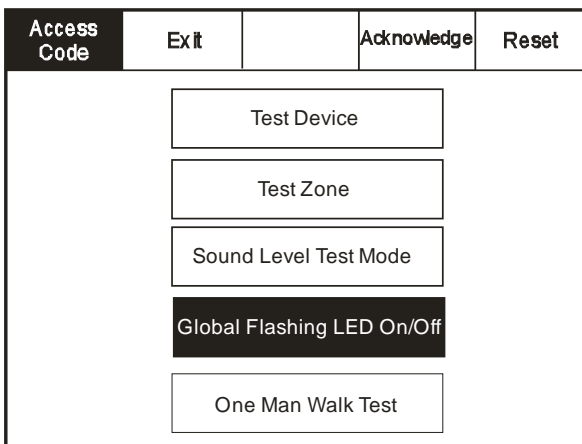

Select "Global Flashing LED On/Off" from the Test Menu Screen.

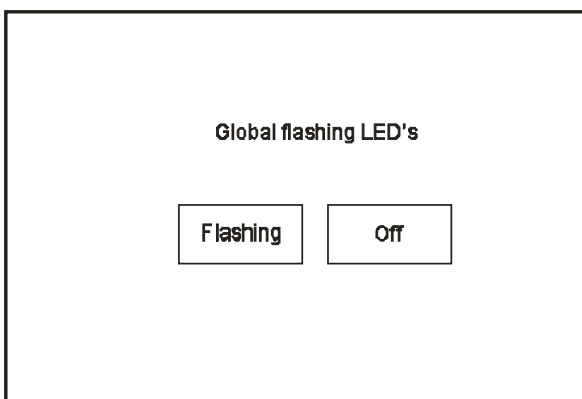

### 7.21 One man walk test

To activate the touch screen, touch the top left corner of the screen until the screen illuminates. To enter the supervisor mode touch the supervisor button and enter the service passcode.

Enter the Service Mode and Select Test.

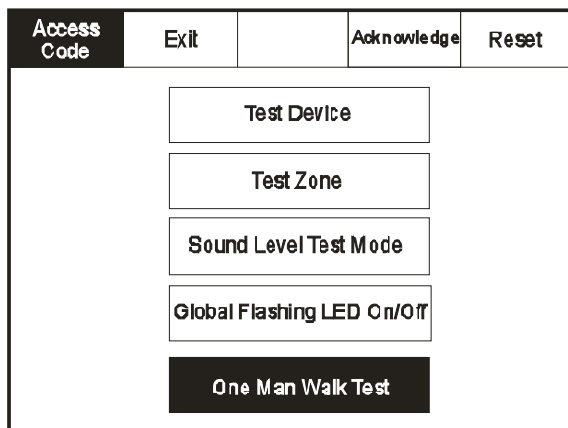
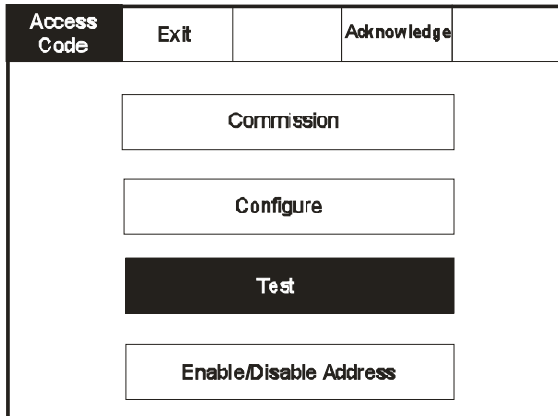

Select "One Man Walk Test" from the Test Menu Screen.



## 7 Panel controls & indicators

### 7.22 Commission: Load CDR from laptop

To activate the touch screen, touch the top left corner of the screen until the screen illuminates. To enter the supervisor mode touch the supervisor button and enter the service passcode.

Enter the Service Mode and Select Commission.

Access Code	Exit		Acknowledge
<div style="background-color: black; color: white; padding: 5px; margin-bottom: 10px;"><b>Commission</b></div> <div style="border: 1px solid black; padding: 5px; margin-bottom: 10px; width: 80%; margin: auto;">Configure</div> <div style="border: 1px solid black; padding: 5px; margin-bottom: 10px; width: 80%; margin: auto;">Test</div> <div style="border: 1px solid black; padding: 5px; width: 80%; margin: auto;">Enable/Disable Address</div>			

Access Code	Exit		Acknowledge	Reset
<b>Load CDR from Laptop</b>		Analogue Level		
Download CDR to Laptop		Printer Settings		
Auto Learn		Change Panel Number		
Erase Log		Number of Panels In Network		
System Detail		Screen Cover		
Load logo from PC		Italian Mode		

**Load CDR from Laptop**

**This will erase the current CDR  
Do you want to continue?**

Yes

No

Select "Load CDR from Laptop" from the Commission Menu"

After pressing "Yes" click commission on the PC download software.

Important:

Do not click commission before pressing "Yes" on the "Load CDR" screen.

### 7.23 Commission: Download CDR to laptop

To activate the touch screen, touch the top left corner of the screen until the screen illuminates. To enter the supervisor mode touch the supervisor button and enter the service passcode.

Enter the Service Mode and Select Commission.

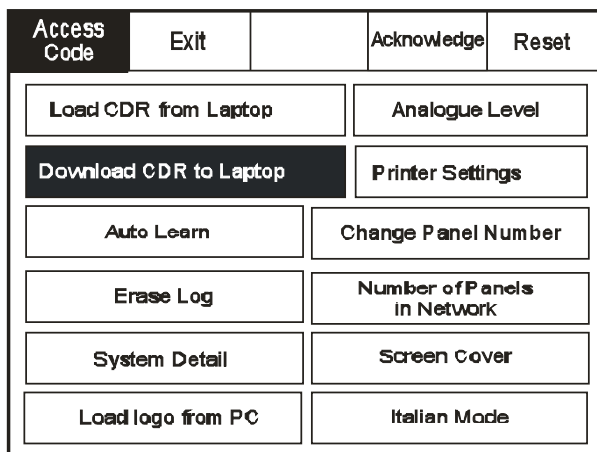
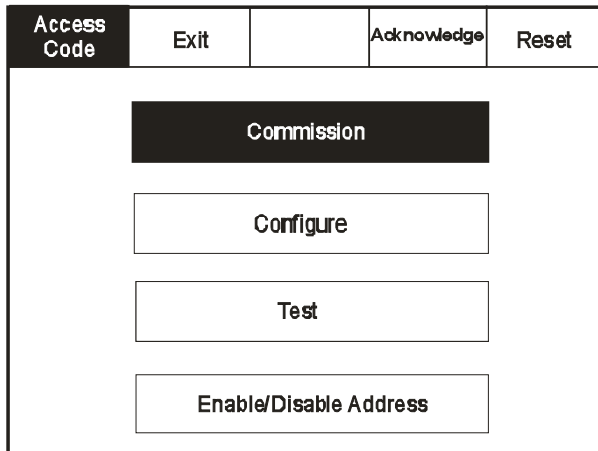

Select "Download CDR from Laptop" from the Commission Menu Screen.

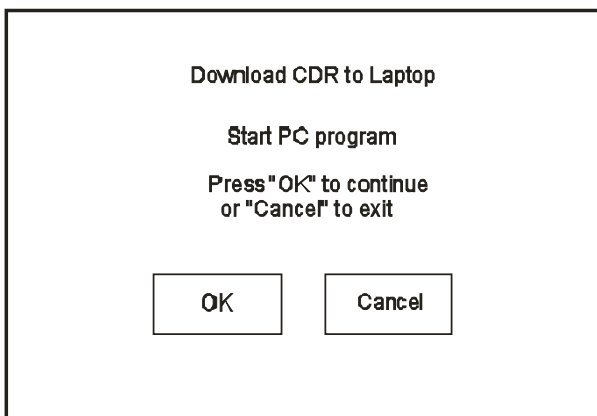

## 7 Panel controls & indicators

### 7.24 Commission: Auto learn

To activate the touch screen, touch the top left corner of the screen until the screen illuminates. To enter the supervisor mode touch the supervisor button and enter the service passcode.

Enter the Service Mode and Select Commission.

Access Code	Exit	Acknowledge	Reset
<b>Commission</b>			
Configure			
Test			
Enable/Disable Address			

Load CDR from Laptop	Analogue Level
Download CDR to Laptop	Printer Settings
<b>Auto Learn</b>	Change Panel Number
Erase Log and Reset	Number of Panels In Network
System Detail	Screen Cover
Load logo from PC	Italian Mode

Select "Auto Learn" from the Configure Menu Screen.

Access Code	Exit	Auto Learn
Do you want to continue ?		
No		
Pre Addresses Autolearn		
Yes - Autolearn All Loops		

Important:

Activating autolearn will erase all existing programming, text and configuration data.



### 7.25 Erase log

To activate the touch screen, touch the top left corner of the screen until the screen illuminates. To enter the supervisor mode touch the supervisor button and enter the service passcode.

Enter the Service Mode and Select Commission.

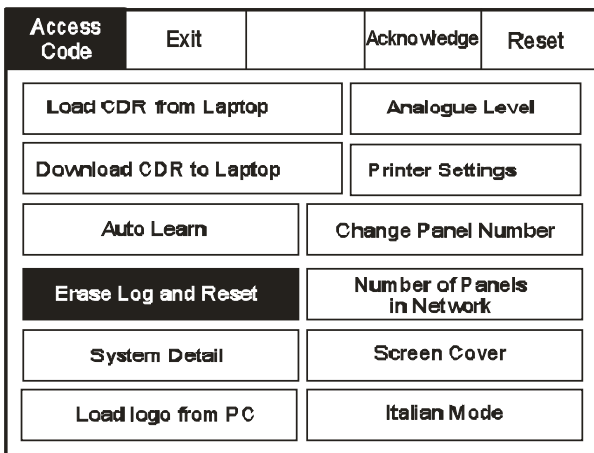
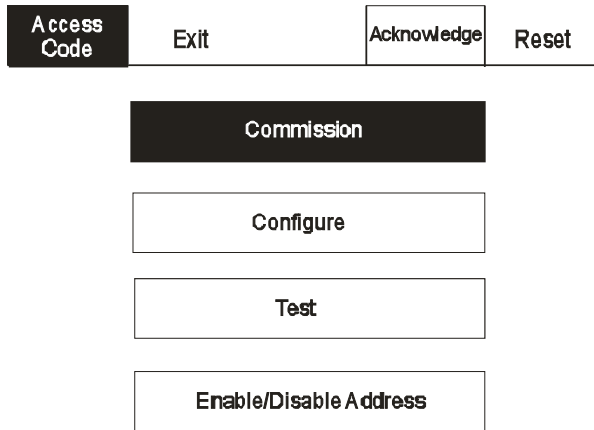

Select "Erase Log and Reset" from the Configure Menu Screen.

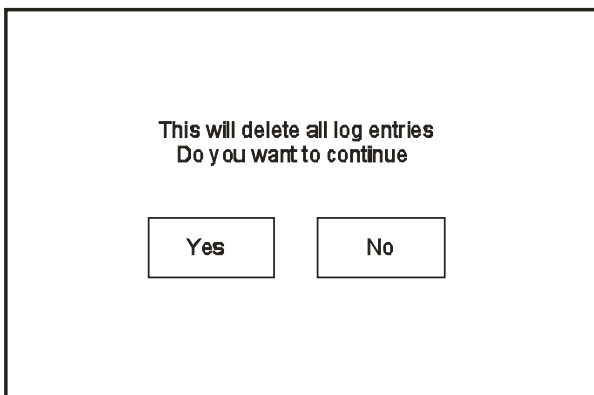

## 7 Panel controls & indicators

### 7.26 Change date/time

Enter the Service Mode and Select Configure. Select Change Date/Time.

Access Code	Exit	Acknowledge	Reset
Programming I/O and Sounders	Add/Delete		
<b>Change Date/Time</b>	Configure Heat Detectors		
Change Text	Network		
Configure Zones	Language		
Change Passcode			

Set the Time Using the Buttons Shown Below.

Access Code	Ok	Cancel	Reset
Current Time:	+1 Hour	+10 Mins	+1 Mins
<b>10:16:12</b>	-1 Hour	-10 Mins	-1 Mins
BST On			
Current Date:	+1 Day	+1 Month	+1 Year
Wednesday dd-mmm-yyyy	-1 Day	-1 Month	-1 Year

### 7.27 Change Text

Enter the Service Mode and Select Configure. Select "Change Text"

Access Code	Exit	Acknowledge	Reset
Programming I/O and NACs	Add/Delete		
Change Date/Time	Configure Heat Detectors		
<b>Change Text</b>	Network		
Configure Zones	Language		
Change Passcode	Day/Night		
Network Protocol			

Set the Time Using the Buttons Shown Below.

Access Code	Exit	Acknowledge	Reset
<b>Change address text</b>			
Change zone text			
Change Panel Text			

Select the Address you wish to change and edit using the keyboard

Access Code	Exit	Reset
Show All	Show Detectors	Show Alarms
Show I/O Units		
001 Device 1, Zone 1 Loop: 1, Zone: 1, Type : Opto/thermal	↑	
002 Device 2, Zone 1 Loop: 1, Zone: 1, Type : Opto/thermal		
003 Device 3, Zone 1 Loop: 1, Zone: 1, Type : Opto/thermal		
004 Device 4, Zone 1 Loop: 1, Zone: 1, Type : Opto/thermal		
005 Device 5, Zone 1 Loop: 1, Zone: 1, Type : Opto/thermal	↓	

Name for address 1											
Address1.....											
←											
1	2	3	4	5	6	7	8	9	0		
Q	W	E	R	T	Y	U	I	O	P		
A	S	D	F	G	H	J	K	L			
CAPS	Z	X	C	V	B	N	M	,	.		
OTHER	SPACE				OK			CANCEL			

### 7.28 Change zone text

Enter the Service Mode and Select Configure.  
Select "Change Text"

<b>Access Code</b>	<b>Exit</b>		<b>Acknowledge</b>	<b>Reset</b>
Programming I/O and Sounders		Add/Delete		
Change Date/Time		Configure Heat Detectors		
<b>Change Text</b>		Network		
Configure Zones		Language		
Change Passcode				

Press "Change Zone Text"

<b>Access Code</b>	<b>Exit</b>		<b>Acknowledge</b>	<b>Reset</b>
Change address text				
<b>Change zone text</b>				
Change Panel Text				

Select the zone you wish to Change and Edit Using the Keyboard

<b>Access Code</b>				<b>Reset</b>
Exit				
Zone 001 Zone 1				↑
Zone 002 Zone 2				
Zone 003 Zone 3				
Zone 004 Zone 4				↓



Enter the name for Zone 2									
Zone 2									←
1	2	3	4	5	6	7	8	9	0
Q	W	E	R	T	Y	U	I	O	P
A	S	D	F	G	H	J	K	L	
CAPS	Z	X	C	V	B	N	M	,	.
OTHER		SPACE			OK		CANCEL		

## 7 Panel controls & indicators

### 7.29 Change panel text

Enter the Service Mode and Select Configure.  
Select "Change Text"

<b>Access Code</b>	<b>Exit</b>		<b>Acknowledge</b>	<b>Reset</b>
Programming I/O and Sounders	Add/Delete			
Change Date/Time	Configure Heat Detectors			
<b>Change Text</b>	Network			
Configure Zones	Language			
Change Passcode				

<b>Access Code</b>	<b>Exit</b>			<b>Reset</b>
Change address text				
Change zone text				
<b>Change Panel Text</b>				

Press "Change Zone Text"

Correct Panel Text									
ULCF3000 and ULCF3000RM.....									←
1	2	3	4	5	6	7	8	9	0
Q	W	E	R	T	Y	U	I	O	P
	A	S	D	F	G	H	J	K	L
CAPS	Z	X	C	V	B	N	M	,	.
OTHER	SPACE			OK			CANCEL		

### 7.30 Configure zones

Enter the Service Mode and Select Configure.  
Select "Configure Zones"

Access Code	Exit	Acknowledge	Reset
Programming I/O and Sounders	Add/Delete		
Change Date/Time	Configure Heat Detectors		
Change Text	Network		
<b>Configure Zones</b>	Language		
Change Passcode			

Access Code	Exit	Reset
Touch row to configure		
<b>Zone 001 Zone 1</b>		
Zone 002 Zone 2		
Zone 003 Zone 3		
Zone 004 Zone 4		

Select Zone into which device will be added

Access Code	Exit	Goto	Reset	
<b>Show All</b>	Show Detectors	Show Alarms	Show I/O Units	Show Selected
001 Device 1, Zone 1 Loop: 1, Zone: 1, Type : Opto/thermal	In Zone	↑		
002 Device 2, Zone 1 Loop: 1, Zone: 1, Type : Opto/thermal	In Zone			
003 Device 3, Zone 1 Loop: 1, Zone: 1, Type : Opto/thermal	In Zone			
004 Device 4, Zone 2 Loop: 1, Zone: 2, Type : Opto/thermal	- ◀			
005 Device 5, Zone2 Loop: 1, Zone: 2, Type : Opto/thermal	-			↓

Touch the dash to move the device into the selected zone.

### 7.31 Change user code

Enter the Service Mode and Select Configure. Select "Change User Code"

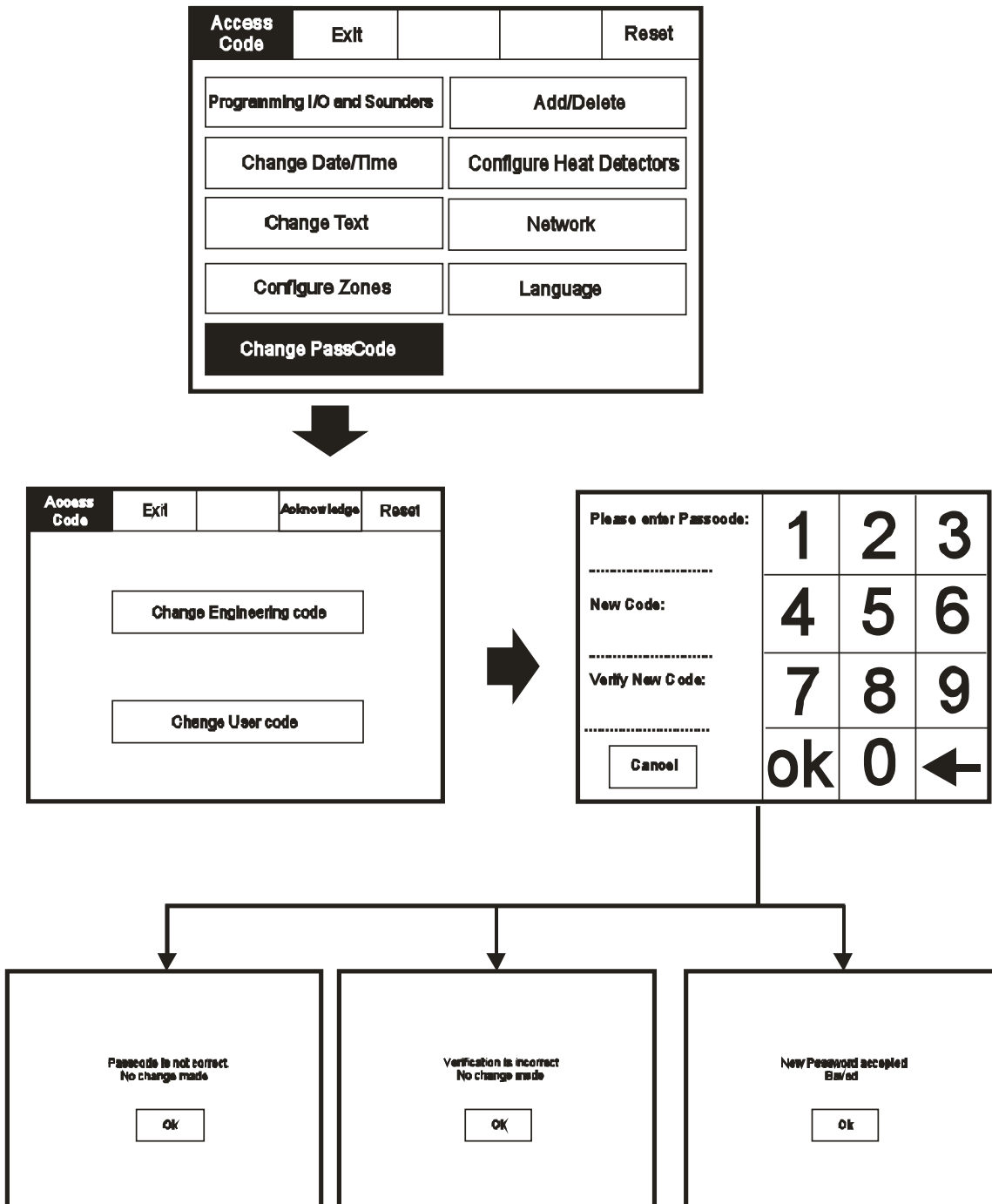

### 7.32 Add zone

Enter the Service Mode and Select Configure. Select "Add Zone"

<b>Access Code</b>	Exit		Acknowledge	Reset
Programming I/O and Sounders		<b>Add/Delete</b>		
Change Date/Time		Configure Heat Detectors		
Change Text		Network		
Configure Zones		Language		
Change Passcode				

<b>Access Code</b>	Exit			Reset				
<table border="1"> <tr><td><b>Add Zone</b></td></tr> <tr><td>Delete Zone</td></tr> <tr><td>Add Device</td></tr> <tr><td>Delete Device</td></tr> </table>					<b>Add Zone</b>	Delete Zone	Add Device	Delete Device
<b>Add Zone</b>								
Delete Zone								
Add Device								
Delete Device								

Add Zone ?	
Yes	No

### 7.33 Delete zone

Enter the Service Mode and Select Configure, select "Add/Delete" then "Delete Zone"

<b>Access Code</b>	Exit			Reset				
<table border="1"> <tr><td>Add Zone</td></tr> <tr><td><b>Delete Zone</b></td></tr> <tr><td>Add Device</td></tr> <tr><td>Delete Device</td></tr> </table>					Add Zone	<b>Delete Zone</b>	Add Device	Delete Device
Add Zone								
<b>Delete Zone</b>								
Add Device								
Delete Device								

<b>Access Code</b>				Reset
Exit	Touch row to delete			
Zone 001 Zone 1				
<b>Zone 002 Zone 2</b>				
Zone 003 Zone 3				
Zone 004 Zone 4				

Delete Zone ?	
Yes	No

## 7 Panel controls & indicators

### 7.34 Add device

Enter the Service Mode and Select Configure, select "Add/Delete" then "Add Device"

Access Code	Exit			Reset
<div style="border: 1px solid black; width: 100px; margin: 5px auto; padding: 5px;">Add Zone</div> <div style="border: 1px solid black; width: 100px; margin: 5px auto; padding: 5px;">Delete Zone</div> <div style="border: 1px solid black; width: 100px; margin: 5px auto; padding: 5px; background-color: #333; color: white;">Add Device</div> <div style="border: 1px solid black; width: 100px; margin: 5px auto; padding: 5px;">Delete Device</div>				

Access Code				Reset
<div style="border: 1px solid black; width: 100px; margin: 5px auto; padding: 5px;">Loop 1</div> <div style="border: 1px solid black; width: 100px; margin: 5px auto; padding: 5px; background-color: #333; color: white;">Loop 2</div> <div style="border: 1px solid black; width: 100px; margin: 5px auto; padding: 5px;">Loop 3</div> <div style="border: 1px solid black; width: 100px; margin: 5px auto; padding: 5px;">Loop 4</div> <div style="border: 1px solid black; width: 50px; margin: 10px auto; padding: 5px;">Exit</div>				

<p>Loop 2</p> <div style="border: 1px solid black; width: 100%; height: 20px; margin: 10px 0;"></div> <p>Scanning Loop</p> <div style="border: 1px solid black; width: 50px; margin: 20px auto; padding: 5px;">Exit</div>
---

Select a Loop to Add a New Device

Confirm New Device and Loop

### 7.35 Delete device

Enter the Service Mode and Select Configure, select "Add/Delete" then "Delete Device"

Access Code	Exit			Reset
<div style="border: 1px solid black; width: 100px; margin: 5px auto; padding: 5px;">Add Zone</div> <div style="border: 1px solid black; width: 100px; margin: 5px auto; padding: 5px;">Delete Zone</div> <div style="border: 1px solid black; width: 100px; margin: 5px auto; padding: 5px;">Add Device</div> <div style="border: 1px solid black; width: 100px; margin: 5px auto; padding: 5px; background-color: #333; color: white;">Delete Device</div>				

Access Code	Exit	Goto		Reset
Touch row to delete				
001	Device 1, Zone 1	Loop: 1, Zone: 1, Type : Opto/thermal	↑	
002	Device 2, Zone 2	Loop: 1, Zone: 2, Type : Opto/thermal		
003	Device 3, Zone 1	Loop: 1, Zone: 2, Type : Opto/thermal		
004	Device 4, Zone 2	Loop: 1, Zone: 2, Type : Opto/thermal		
005	Device 5, Zone 1	Loop: 1, Zone: 1, Type : Opto/thermal	↓	

Select a Device to Delete

Confirm or Cancel Deletion

<p>Delete Device 3?</p> <p>Device 3</p> <p>Loop 1, Address 3, Device Type Opto/thermal</p> <div style="display: flex; justify-content: space-around; margin-top: 10px;"> <div style="border: 1px solid black; width: 40px; height: 20px;"></div> <div style="border: 1px solid black; width: 40px; height: 20px;"></div> </div>
---



### 7.36 Configure heat detectors

Enter the Service Mode and Select Configure. Select "Configure Heat Detectors"

Access Code	Exit	Acknowledge	Reset
Programming I/O and Sounders	Add/Delete		
Change Date/Time	<b>Configure Heat Detectors</b>		
Change Text	Network		
Configure Zones	Language		
Change Passcode			

Access Code	Exit	Goto	Reset
Touch row to configure			
001 Device 1, Zone 1 Loop: 1, Zone: 1, Type : Opto/thermal			↑
002 Device 2, Zone 2 Loop: 1, Zone: 2, Type : Opto/thermal			
003 Device 3, Zone 1 Loop: 1, Zone: 2, Type : Opto/thermal			
004 Device 4, Zone 2 Loop: 1, Zone: 2, Type : Opto/thermal			
005 Device 5, Zone 1 Loop: 1, Zone: 1, Type : Opto/thermal			↓

Select appropriate detector class

Access Code	Reset
<b>Thermal A1R</b>	
Thermal B8	
Thermal C5	
Exit	

### 7.37 Network

Enter the Service Mode and Select Configure. Select "Network"; this menu defines whether messages are broadcast across the network or remain local.

Access Code	Exit	Acknowledge	Reset
Programming I/O and Sounders	Add/Delete		
Change Date/Time	Configure Heat Detectors		
Change Text	<b>Network</b>		
Configure Zones	Language		
Change Passcode			

Select a Device to Configure

Access Code	Exit	Receive message over network
Reset		Network
Evacuate/Drill		Network
Silence		Network
Alarm		Network
Trouble		Network
Pre-Alarm		Network

## 7 Panel controls & indicators

### 7.38 Password protection

<b>Access Code</b>	<b>1</b>	<b>2</b>	<b>3</b>
<b>Please enter Passcode</b> .....	<b>4</b>	<b>5</b>	<b>6</b>
	<b>7</b>	<b>8</b>	<b>9</b>
<input type="button" value="Cancel"/>	<b>ok</b>	<b>0</b>	<b>←</b>

The Menvier ULCF3000 and ULCF3000RM system has password protection which restricts access to the DISABLE Menu and to TEST/COMMISSIONING MODE. The password is a four digit code and the default number is 2214 for access level two and 143243 for access level three. The password entry screen is accessed via the supervisor mode button. Press supervisor mode and the password entry screen will be displayed, type in the passcode and press Ok. If the wrong password is entered three times further access to the system is denied.

### **8 Battery disposal instructions**

Although batteries contain lead and small amounts of antimony and arsenic, they are safe if handled according to the accompanying guide. The battery cells must not be dismantled as this involves several hazards, which are best handled under controlled conditions, using specialised equipment. No attempt should be made to repair any batteries; they should be treated as disposable when they have outlived their use.

Batteries must be disposed of in accordance with current waste disposal and pollution legislation and in particular; The Environment Protection Act 1990, Special Waste Regulation 1996. It is recommended that the following authorities are contacted before any attempt is made to dispose of batteries; Environment Agency Local office, Local Authority Environmental Health or Waste Handling department.

## 9 Compatibility List

Name of panel	Model number of device	Description	File number
ULCF30002G, ULCF30004G, ULCF30002GP, ULCF30004GP, ULCF30002GNC, ULCF30004GNC, ULCF30002GPNC, ULCF30004GPNC, ULCF30002GRM, ULCF30004GRM, ULCF30002GPRM, ULCF30004GPRM, ULCF30002GNCRM, ULCF30004GNCRM, ULCF30002GPNCRM, ULCF30004GPNCRM, ULR3000L2, ULR3000L4, ULR3000L2NC & ULR3000L4NC	ULCAPT340, UCAPT340	Analog Photoelectric Smoke, Complimentary Fixed Temperature Heat Detector	S35885
	UCPT-2W	Conventional Photoelectric Smoke, Complementary Fixed Temperature Heat Detector	S35885
	ULCAH330	Analog Fixed Temperature Heat Detector	S35887
	UCHR-2W, UCHRI-2W,	Conventional Combination Electronic Fixed Temperature And Rate-Of-Rise Heat Detector	S35887
	UCHT-2W, UCHTI-2W	Conventional Electronic Fixed Temperature Heat Detector	S35887
	ULCAP320 & UCAP320	Analog Photoelectric Smoke Detector	S24205
	CIR301	Remote Indicator	S35888
	ULCMIO353	230v Relay I/O Unit	S24988
	ULCIO351	3 Channel I/O Unit	S24988
	ULCSC354	4 Way Sounder Controller	S24988
	ULCF3000PR	Loop Repeater	S24988
	ULCTPR3000	Network Repeater	S24988
	ULCSUM355	Shop Unit Monitor	S24988
	ULMCIM-C	Single Input Module	S24988
	ULMCOM-S	Single Output Module	S24988
	ULCSI350	Spur Isolator Unit	S24988
	ULCZMU352	Zone Monitor Unit	S24988
	ULMCIM	Input Module	S24988
	ULMIU872	Mini Zone Monitor Module	S24988
	ULMCOM	Output Module	S24988
	UMPS-1-0 & UMPS-200, For outdoor use when used with Model SGB32C back box.	Addressable Pull Stations	S25161

Name of panel	Model number of device	Description	File number
ULCF30002G, ULCF30004G, ULCF30002GNC, ULCF30004GNC, ULCF30002GP, ULCF30004GP, ULCF30002GPNC, ULCF30004GPNC, ULCF30002RM,	ULFX340	Analog Photoelectric Smoke, Complimentary Fixed Temperature Heat Detector	S35885
	UCPT-2W	Conventional Photoelectric Smoke, Complementary Fixed Temperature Heat Detector	S35885
	ULFX330	Analog Fixed Temperature Heat Detector	S35887

ULCF30004RM,  
ULCF30002NCRM,  
ULCF30004NCRM,  
ULCF30002PRM,  
ULCF30004PRM,  
ULCF30002PNCRM  
ULCF30004PNCRM  
ULCFR3000L2,  
ULCFR3000L4,  
ULCFR3000L2NC,  
ULCFR3000L4NC.

UCHR-2W, UCHRI- 2W	Conventional Combination Electronic Fixed Temperature And Rate-Of-Rise Heat Detector	S35887
UCHT-2W, UCHTI-2W	Conventional Electronic Fixed Temperature Heat Detector	S35887
ULMAP320	Analog Photoelectric Smoke Detector	S24205
DIR301	Remote Indicator	S35888
ULCMIO353	230v Relay I/O Unit	S24988
ULCIO351	3 Channel I/O Unit	S24988
ULCSC354	4 Way Sounder Controller	S24988
ULCF3000PR, ULCF3000PR	Loop Repeater	S24988
ULCTPR6000	Network Repeater	S24988
ULCSUM355	Shop Unit Monitor	S24988
ULMCIM-C	Single Input Module	S24988
ULMCOM-S	Single Output Module	S24988
ULCSI350	Spur Isolator Unit	S24988
ULCZMU352	Zone Monitor Unit	S24988
ULMCIM	Input Module	S24988
ULMIU872	Mini Zone Monitor Module	S24988
ULMCOM	Output Module	S24988
UMPS-100 & UMPS-200, For outdoor use when used with Model SGB32C back box.	Addressable Pull Stations	S25161

Name of panel	Model number of device	Description	File number
ULCF30002G, ULFX60004G, ULFX340		Analog Photoelectric Smoke, Complimentary Fixed Temperature Heat Detector	S35885
ULCF30002GNC, ULCF30004GNC, ULCF30002GP, ULCF30004GP, ULCF30002GPNC, ULCF30004GPNC, ULCF30002RM, ULCF30004RM, ULCF30002NCRM, ULCF30004NCRM, ULCF30002PRM, ULCF30004PRM, ULCF30002PNCRM, ULCF30004PNCRM, ULCFR3000L2, ULCFR3000L4, ULCFR3000L2NC, ULCFR3000L4NC.	UCPT-2W	Conventional Photoelectric Smoke, Complimentary Fixed Temperature Heat Detector	S35885
	ULCF330	Analog Fixed Temperature Heat Detector	S35887
	UCHR-2W, UCHRI- 2W	Conventional Combination Electronic Fixed Temperature And Rate-Of-Rise Heat Detector	S35887
	UCHT-2W, UCHTI-2W	Conventional Electronic Fixed Temperature Heat Detector	S35887
	ULMAP320	Analog Photoelectric Smoke Detector	S24205
	DIR301	Remote Indicator	S35888
	ULCMIO353	230v Relay I/O Unit	S24988
	ULCIO351	Channel I/O Unit	S24988
	ULCSC354	4 Way Sounder Controller	S24988
	ULCF3000PR, ULCF3000PR	Loop Repeater	S24988
	ULCTPR6000	Network Repeater	S24988
	ULCSUM355	Shop Unit Monitor	S24988
	ULMCIM-C	Single Input Module	S24988
	ULMCOM-S	Single Output Module	S24988
	ULCSI350	Spur Isolator Unit	S24988
	ULCZMU352	Zone Monitor Unit	S24988
	ULMCIM	Input Module	S24988
	ULMIU872	Mini Zone Monitor Module	S24988
	ULMCOM	Output Module	S24988
	UMPS-100 & UMPS-200, For outdoor use when used with Model SGB32C back box.	Addressable Pull Stations	S25161

**Eaton**  
EMEA Headquarters  
Route de la Longeraie 7  
1110 Morges, Switzerland  
Eaton.eu

© 2018 Eaton  
All Rights Reserved  
Publication No. PR209-171-505-13 /  
25-14533-M  
CSSC-935 February 2018

Eaton is a registered trademark.

All trademarks are property of their respective owners.