

- 1 - EPCT TOUCHSCREEN
- 2 - EXTERNAL USB PORT
- 3 - MAIN POWER SWITCH
- 4 - START PUSHBUTTON
- 5 - STOP PUSHBUTTON
- 6 - MSH (EMERGENCY START HANDLE)
- 7 - RECOMMENDED CABLE ACCESS (BOTTOM ONLY)

NOTES:
 1 - DIMENSIONS: in [mm]
 2 - ALL ENCLOSURES FINISHED IN RED
 3 - STANDARD ENCLOSURE: TYPE (NEMA) 2

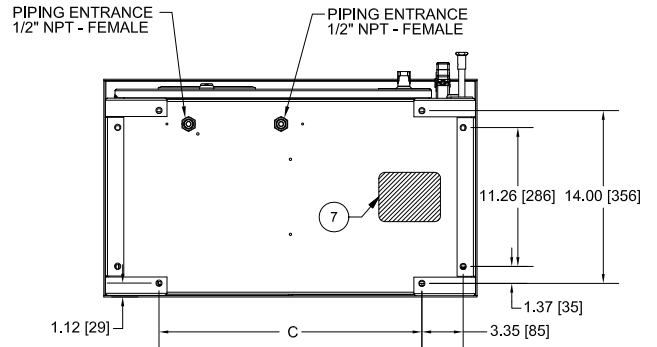

Motor HP	Line voltage	Withstand rating			Approximate weight Lbs. (Kg)	A	B	C
		Standard	Intermediate	High				
50 - 100	200 - 208V	100,000	150,000	200,000	275 (124)	41.83 [1062]	30.25 [768]	21.30 [541]
60 - 125	220 - 240V							
100 - 200	380 - 415V							
125 - 250	440 - 480V							
125 - 300	550 - 600V	25,000	100,000					
125 - 150	200 - 208V	100,000	150,000	200,000	370 (167)	54.83 [1393]	43.25 [1099]	34.30 [871]
150 - 200	220 - 240V							
250 - 300	380 - 415V							
300 - 400	440 - 480V							
350 - 400	550 - 600V	25,000	100,000					