

Line Terminals Connections

Max HP	Line Voltage					Line Lugs (QTY.) & Cable Size per Ø	Service Ground Lugs (QTY.) & Cable Size per Ø
	200-208	220-240	380-415	440-480	575-600		
25	30	40	60	75	(1) #14 - 1/0 (CU/AL)	(1) #14 - 2/0 (CU/AL)	
40	50	75	100	100	(1) #4 - 4/0 (CU)	(1) #4 - 350MCM (CU/AL)	
75	75	150	200	200	(1) #3 - 350MCM (CU/AL)	(1) #4 - 350MCM (CU/AL)	
100	125	200	250	300	(2) 3/0 - 350MCM (CU/AL)	(2) 1/0 - 750MCM (CU/AL)	
150	200	300	400	500	(2) 250 - 350MCM (CU/AL)	(2) 1/0 - 750MCM (CU/AL)	

Load Terminals Connections

Max HP	Line Voltage					Single Run Cable Sizes	Double Run Cable Sizes
	200-208	220-240	380-415	440-480	575-600		
10	10	15	20	25	#14 - #8 (CU/AL)	#14 - #8 (CU/AL)	
20	25	30	50	60	#14 - #1 (CU/AL)	#14 - #2 (CU/AL)	
40	60	75	125	100	#8 - 3/0 (CU/AL)	#8 - 2/0 (CU/AL)	
75	100	150	200	200	#2 - 750MCM (CU/AL)	1/0 - 250MCM (CU/AL)	
150	200	300	400	500	1/0 - 500MCM (CU/AL)	1/0 - 500MCM (CU/AL)	

For ambient temperatures exceeding 30C (86F), the temperature rating of motor conductors is recommended to be a minimum of 90C (194F)

For proper cable size, refer to the National Electric Code (NEC - NFPA70)

CONTROLLER CONNECTIONS

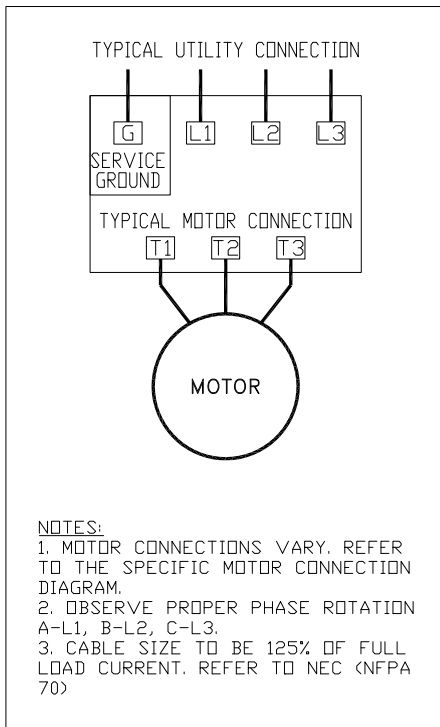

ALARM CONTACTS

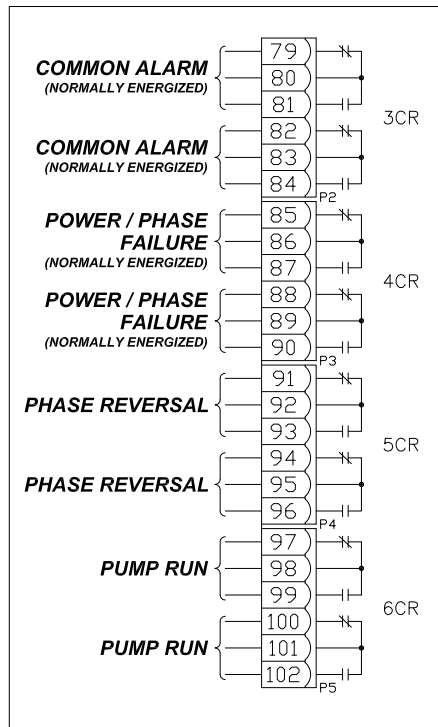

CUSTOMER INPUTS

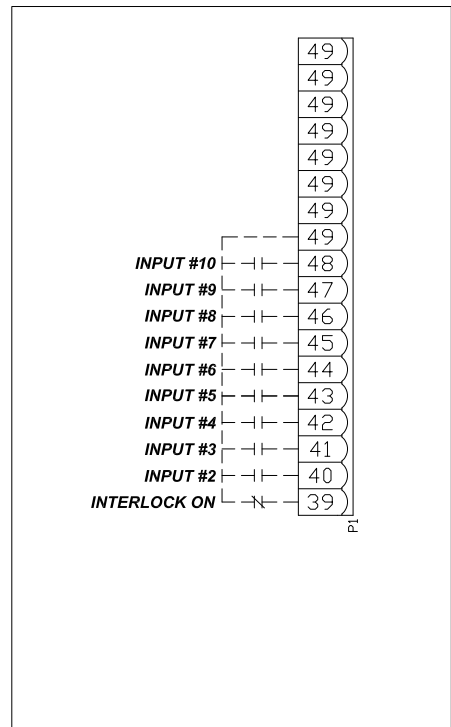

TRANSFER SWITCH CONNECTIONS (IF EQUIPPED)

