

- 1 - EPCT TOUCHSCREEN
- 2 - EXTERNAL USB PORT
- 3 - MAIN POWER SWITCH
- 4 - START PUSHBUTTON
- 5 - STOP PUSHBUTTON
- 6 - MSH (EMERGENCY START HANDLE)
- 7 - RECOMMENDED CABLE ACCESS (BOTTOM ONLY)

NOTES:
 1 - DIMENSIONS: in [mm]
 2 - ALL ENCLOSURES FINISHED IN RED
 3 - STANDARD ENCLOSURE: TYPE (NEMA) 2

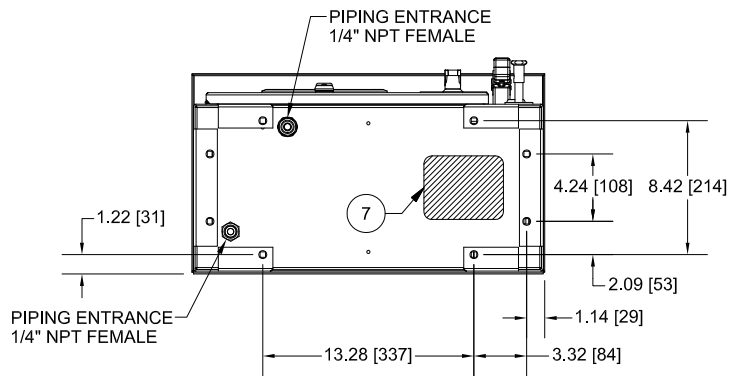

Motor HP	Line voltage	Withstand rating			Approximate weight Lbs. (Kg)
		Standard	Intermediate	High	
5 - 40	200 - 208V	100,000	150,000	200,000	180 (81)
5 - 50	220 - 240V				
5 - 75	380 - 415V				
5 - 100	440 - 480V				
5 - 100	550 - 600V	25,000	100,000		