

# Diesel Engine Additive (Foam) Pump Controllers



## Product Description

The DIESEL Plus Foam Pump Controllers from Eaton are designed to control and monitor 12 or 24 volt, diesel fire pump engines and are among the most technically advanced diesel engine controllers available.

They are an enhanced version of the original microprocessor-based, FD100 Series of diesel engine controllers. Programming is straightforward due to the use of the core firmware and menu structure utilized in the LMR Plus Series of electric controllers.

The controller can be ordered with the option to display and output current values and status, on command, from various software protocols.

An embedded web page for retrieving diagnostics and history reports, can be accessed from the optional Ethernet communication port. An optional RS485 serial port can be used for direct connection to a computer for data transfer.

## Product Features Communication

### Embedded Web Page

The embedded web pages allow the user to view the current status of the controller as well as all amperage readings, set points, diagnostics, statistics, configuration and history. An external computer connected via the optional ethernet port is used to access the pages. The specific data required can be downloaded for reference purposes.

### Communication Types

#### USB

The USB port is used to download the controller message history, statistics, diagnostics, status and configuration data to a USB disk drive. The USB port can also be used to upload custom messages, additional languages, and update the microprocessor firmware.

#### Ethernet

An external computer can communicate with the Diesel Plus controller via the optional ethernet port. An embedded web page will display the controller's current status, as well as display all current readings, set points and history.

#### Modbus

The Diesel Plus foam pump controllers have the option to communicate to systems using the Regular level of Modbus (includes both RTU and ASCII transmission modes). Communication settings are user configurable through the Diesel Plus configuration menu.

### Field Connections

#### Standard Inputs

- Remote Start
- Fuel Spill
- Deluge Valve
- Low Foam Level
- Interlock On
- Remote Auto Start
- Low Fuel
- Programmable Inputs (9)

#### Programmable Inputs

Up to 9 additional, programmable inputs can be programmed to indicate up to 13 different types of inputs. They can be programmed to energize the common alarm output, link to relays and optional LED's and latch until reset by the user. All optional inputs, outputs and LED's can be linked, as required. They can also be programmed with time delay functions.

### Standard Output Relays

All standard output relays are 8 amp, DPDT.

- Interlock On
- Future # 2
- Low Fuel
- Auto Mode
- Common Alarm

### Optional Output Relays

There is provision to add up to eight additional relay outputs, via four optional relay output boards which mount in a snap-on configuration. Each board contains a maximum of 2 additional relays.



### Engine Run Relay

The Power I/O Board houses a 10 Amp engine run relay which is used for alarm purposes, or to power external louvers.

### Common Alarm Relay

The FDF120 controller has a common alarm relay which de-energizes whenever there are any alarm conditions present. This relay is energized under normal conditions and has LED status indication.

### Alarm Relay Rating

All alarm relays are rated 8 amps, 250Vac, resistive load only.

### Programmable Outputs

Up to 10 additional, programmable outputs (two standard; eight via optional output boards) can be programmed to indicate up to 45 output conditions. They can be programmed for fail safe and latch until reset by the user. All optional inputs, outputs and LED's can be linked, as required. They can also be programmed with time delay functions. As well, two optional alarm LED's can be programmed for up to 28 alarm conditions.

### Power / Voltage

**Universal Voltage Supply**  
The controller can be powered with supply voltages from 100Vac to 240Vac by connecting to the three input terminals L,N,G located on the bottom left of the engine board.



### Dual Output

12 or 24Vdc output is selectable via a DIP Switch located on the battery chargers. Note: Each controller is factory set for 12Vdc. If 24Vdc is required from the factory, it should be noted on the ordering information.

### Line Filter

A line filter incorporated onto the engine board, is used to reduce/eliminate external incoming voltage transients.

### AC Power Disconnect

A breaker located inside the controller on the Engine Board, is used to switch on and off AC power to the unit. It will illuminate when energized.

### DC Power Disconnect

The engine board houses two on-board circuit breakers used to switch on or off DC power from the batteries.

Each breaker has an LED mounted on the engine board that illuminates when the breaker is energized.

## Alarm and Status Indication

### Accessibility

All alarm and status LED's as well as the LCD Display and programming buttons are accessible from the front of the controller.

## LCD Display

The Controller Display Board contains a 4 Line by 40 Characters wide, backlit, LCD display which is capable of generating multiple languages. The display will show the current system pressure, time and date, charger output voltage and any custom messages, alarms or timer values.



## Status LED's

The controller is supplied with six (6) green status LED's for the following:

- LOW PRESSURE
- ENGINE RUN
- REMOTE START
- INTERLOCK ON
- DELUGE VALVE
- One Programmable LED

## Alarm LED's

The controller is supplied with twenty (20) red alarm LED's for the following:

- BATTERY #1 FAILURE
- CHARGER # 1 FAILURE
- BATTERY #2 FAILURE
- CHARGER # 2 FAILURE
- LOW PRESSURE
- SYSTEM OVER PRESSURE
- LOW FOAM LEVEL
- LOW FUEL
- FAIL TO START
- HIGH ENGINE TEMP
- LOW OIL PRESSURE
- ENGINE OVER SPEED
- ECM SELECTOR IN ALT POSITION
- FUEL INJECTION MALFUNCTION
- ECM WARNING
- ECM FAILURE
- HIGH RAW WATER TEMP.
- LOW ENGINE TEMPERATURE
- FUEL SPILL
- One Programmable LED

## Statistics

Up to 26 statistical points are recorded to provide a quick review of how the system has been operating. The statistics can be viewed on the main display, saved to a USB disk drive, or viewed on the embedded webpage.

## Diagnostics

Up to fifty three diagnostic points are recorded that can be used to help in troubleshooting issues with the controller. The diagnostics can be viewed on the main display, saved to a USB disk drive, or viewed on the embedded webpage.

## Message History

Up to 10k alarm/status messages can be stored in the controller memory. They can be viewed on the main display, saved to a USB disk drive, or viewed on the embedded webpage.

## DC Fail

A visual indication and audible alarm is provided to indicate DC power loss due to one or both batteries being disconnected from the controller. This indication will also be provided if the controller is not operating due to an electronic board failure.

## Programmable Features

- Languages
  - (English, French, Spanish Standard. Other languages are available. Consult factory.)
- Date and Time
- Pressure Start and Stop Points
- Low and High Pressure Alarms
- Stop Mode
- Low Suction Shutdown
- Pressure Recording Parameters
- Run Period Timer
- Weekly Test Timer
- Sequential Start Timer
- AC Failure Alarm
- AC Fail to Start

## Enclosures

### Ratings

All FDF120 controllers come standard with NEMA 2 enclosures unless otherwise ordered.

Available options include: NEMA 3R, 4, 4X, 12.

## Reduced Size

A streamlined internal design has allowed the overall size of the DIESEL Plus controllers to be reduced from previous models. See dimensional drawings on our website.



## Technical Specifications

- Supply Voltage: 100-240Vac
- Output Voltage: 12-24Vdc
- Hertz: 50/60 Hz
- Enclosure:
  - Standard NEMA 2
  - Optional NEMA 3R, 4, 4X, 12
- Temperature:
  - 4 to +50 deg. C
  - 39 to +122 deg. F
- Alarm Relays: DPDT 8amp
- Engine Run Relay: DPDT 10amp
- Crank / Fuel Stop Relays: SPDT
- Pressure Transducer: 500psi
- Immunity Compliance:
  - Environment A
  - Emission Compliance: Environment B

## Battery Chargers

- Mode: Switching
- Dual 10 Amp
- Communication to Power I/O Board
- Diagnostics Recording
- Lead Acid or NiCad Three Step Charge
- Internal Temperature Monitoring
- Universal Voltage Input
- Selectable Dual Voltage Output



## Standards & Certification

The FDF120 Diesel Engine Fire Pump Controllers meet or exceed the requirements of Underwriters Laboratories, Factory Mutual Research (FM), the Canadian Standards Association, New York City building code, CE mark and U.B.C. / C.B.C Seismic requirements, and are built to NFPA 20 standards.



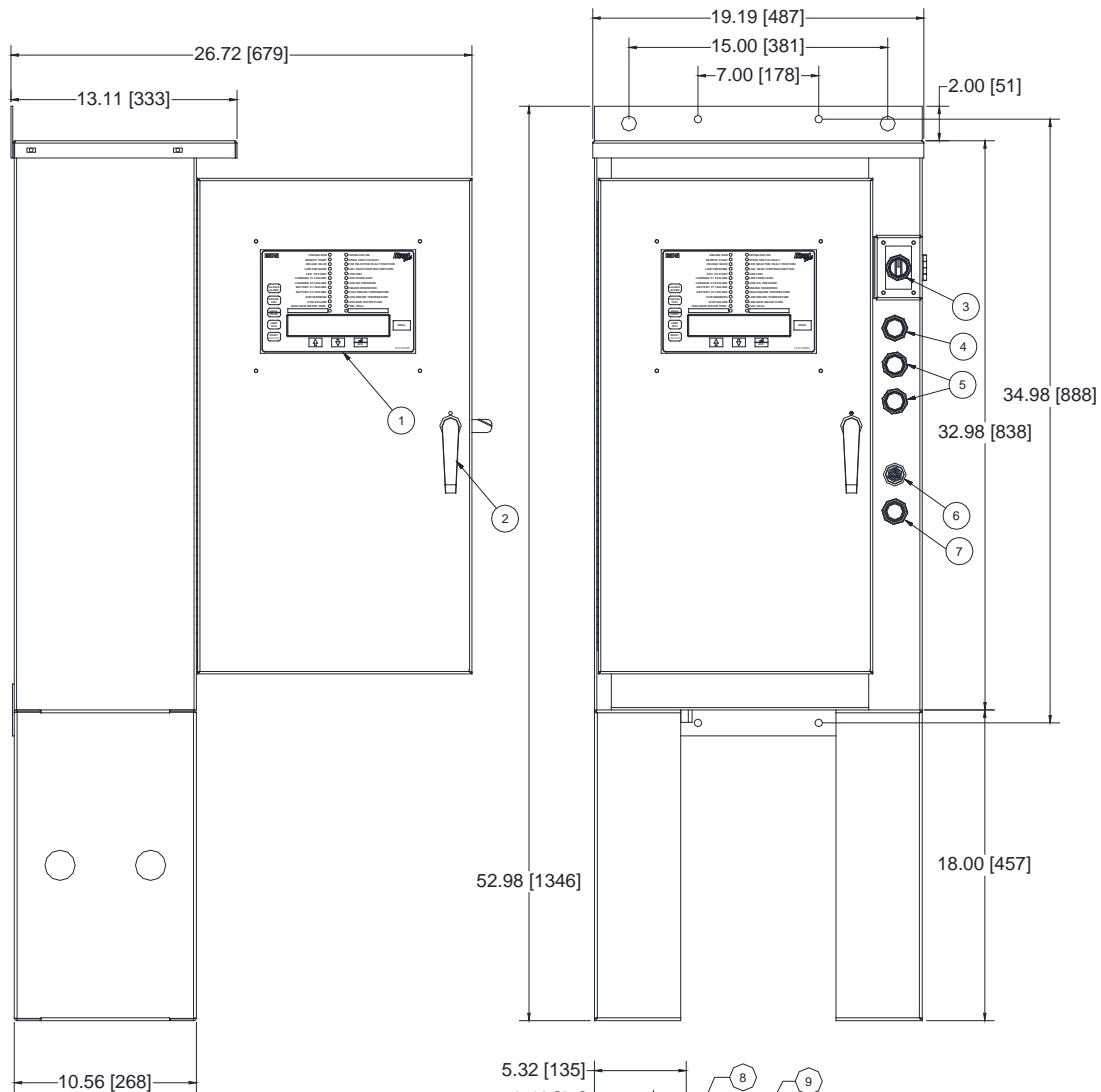

- 1 - DIESEL PLUS MEMBRANE
- 2 - LOCKABLE HANDLE
- 3 - HAND OFF AUTO SELECTOR SWITCH
- 4 - STOP BUTTON
- 5 - CRANK BUTTONS
- 6 - AUDIBLE ALARM
- 7 - DC FAIL LIGHT
- 8 - DISCHARGE 1/4" NPT - FEMALE
- 9 - SENSING LINE 1/2" NPT - FEMALE
- 10 - ALLOWABLE CABLE ENTRY/EXIT AREA

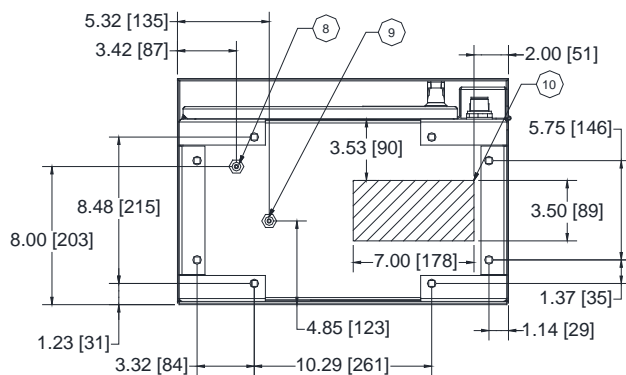

Approximate Weight

Lbs.	(Kg)
105	(48)

NOTES:

- 1. All enclosures finished in FirePump red.
- 2. Cable Entrance bottom only.
- 3. Standard Enclosure type NEMA 2
- 4. Enclosure made from #14 Gauge (0.75) HR Steel.
- 5. Feet are removable.

\* NEMA 4, 4X enclosures are supplied:  
 With 1/4 Turn latches instead of a standard handle.

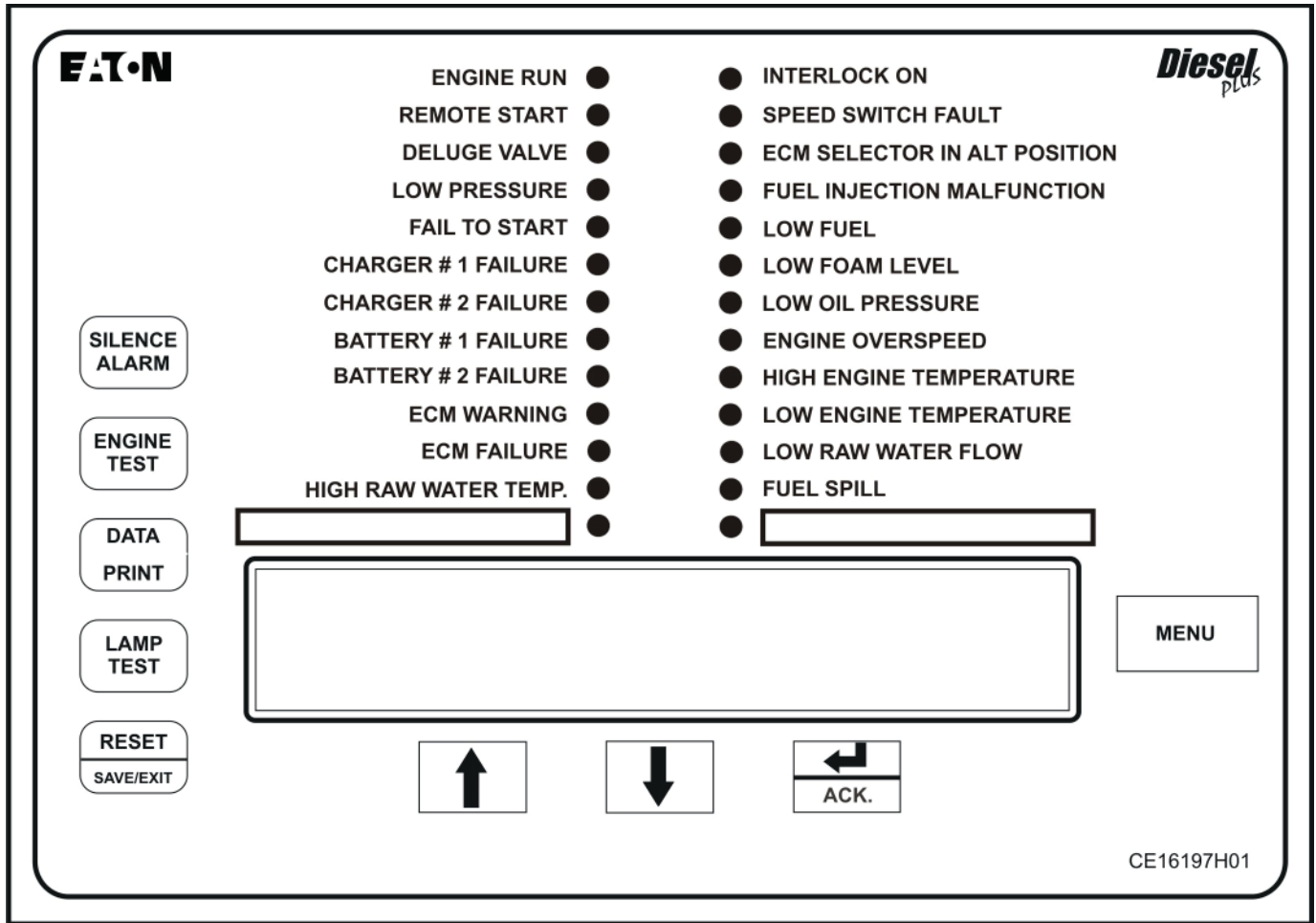

NOTES:

1. Refer to the DIESEL Plus technical manual for details and setup information, as well as programming and custom labeling for the Programmable LED's.

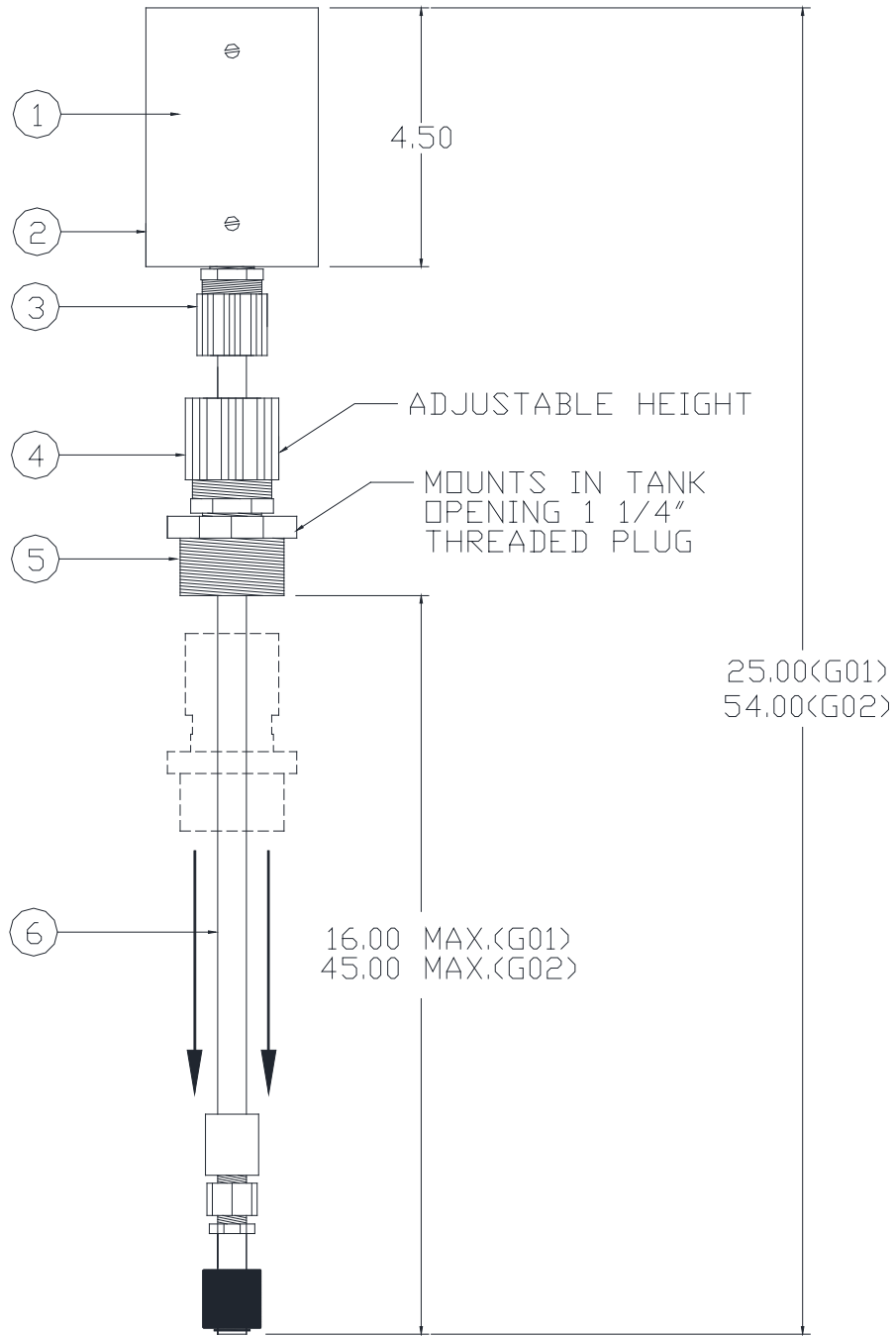

Dimensions in Inches

3A14119G01: 16 inch unit  
3A14119G02: 45 inch unit





## Field Connections

### Engine Board Terminal Blocks

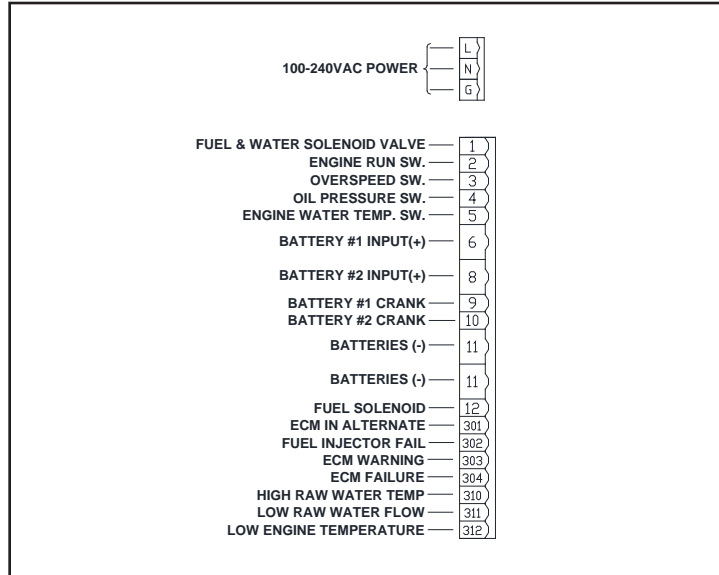

### Inputs

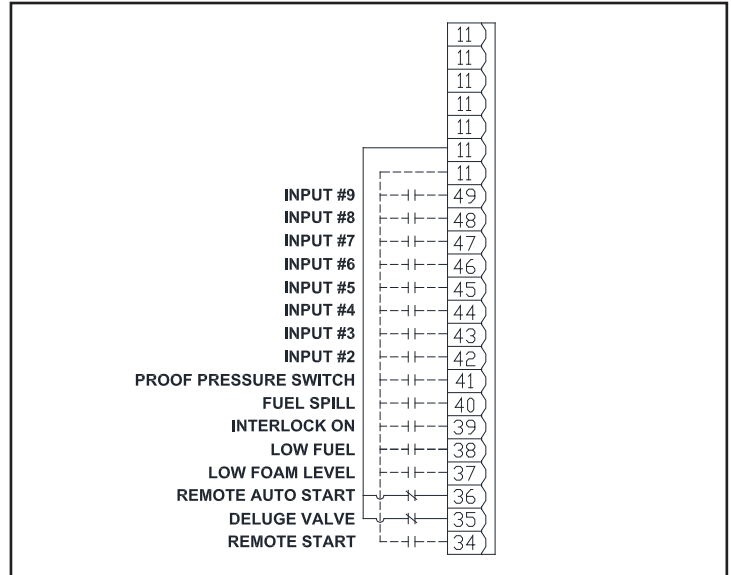

### Outputs

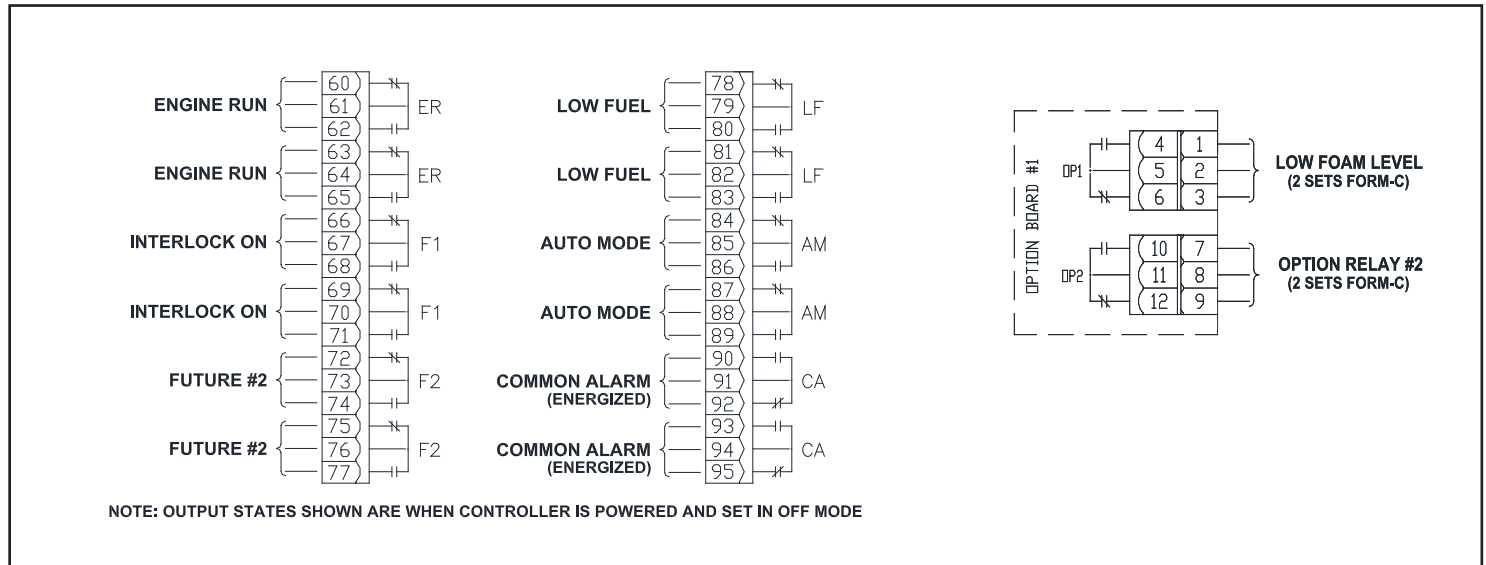

## Technical Data and Specifications

### Line Terminals (Incoming Cables)

Recommended Wire Size	Terminal Number	Distance
I/O Board Stranded # 14 (1.63mm) Stranded # 14 (1.63mm)	11, 34-39, 60-95 Option Board Terminals	N. A. N. A.
Engine Board Stranded # 14 (1.63mm)	1-5, 9, 10, 12, 301, 302, 303, 304, 310, 311, 312 L, N, G	N. A.
Battery Wire Stranded # 10 (2.59mm) Stranded # 8 (3.26mm)	6, 8, 11 6, 8, 11	0 feet to 25 feet (7.62m) 25 feet to 50 feet (7.62-15.24m)



## Technical Data and Specifications - LMR Plus Electric Controllers Line Terminals on Main Isolation Switch (Incoming Cables)

### Qty. & Cable Sizes

American Wire Gauge (AWG /MCM)	Diameter (mm)
(1)#14-1/0 PER Ø (CU/AL)	(1.63 - 5.83 mm)
(1)#4-4/0 PER Ø (CU)	(5.83 - 11.68 mm)
(1)#3-350MCM PER Ø (CU/AL)	(5.83 -15.03 mm)
(2)3/0-250MCM PER Ø (CU/AL)	((10.40 - 12.70 mm)
(2)2/0-250-350MCM PER Ø (CU/AL)	((12.70 - 15.03 mm)
(2)#1-500MCM PER Ø (CU/AL)	((7.35 - 17.96 mm)
(3)3/0-400MCM PER Ø (CU/AL)	((10.40 - 16.06 mm)

### Service Entrance Ground Lug - Qty. & Cable Sizes

American Wire Gauge (AWG /MCM)	Diameter (mm)
(1)#14-2/0 PER Ø (CU/AL)	(1.63 - 9.27 mm)
(1)#4-350MCM PER Ø (CU/AL)	(5.19 - 15.03 mm)
(2)1/0-750MCM PER Ø (CU/AL)	(8.25 -22.00 mm)

## Load Terminals (To Motor)

### Qty. & Cable Sizes

American Wire Gauge (AWG /MCM)	Diameter (mm)
(1)#4-#3 PER Ø (CU)	(1.63 - 5.83 mm)
(1)#4-4/0 PER Ø (CU/AL)	(1.63 - 8.25 mm)
(1)#6-250MCM PER Ø (CU/AL)	(4.11 -12.70 mm)
(2)1/0-250MCM PER Ø (CU/AL)	((8.25 - 12.70 mm)
(2)2/0-500MCM PER Ø (CU/AL)	((9.27 - 17.96 mm)

For Proper Cable Size Refer to National Electrical Code NFPA-70.

## Technical Data and Specifications - DIESEL Plus Diesel Engine Controllers Line Terminals (Incoming Cables)

Recommended Wire Size	Terminal Number	Distance
<b>I/O Board</b>		
Stranded # 14 (1.63 mm)	11, 34-49, 60-95	N. A.
Stranded # 14 (1.63 mm)	Option Board Terminals	N. A.
<b>Engine Board</b>		
Stranded # 14 (1.63 mm)	1-5, 9, 10, 12, 301, 302, 303, 304, 310, 311, 312, L, N, G	N. A.
<b>Battery Wire</b>		
Stranded # 10 (2.59 mm)	6, 8, 11	0 feet to 25 feet (7.62m)
Stranded # 8 (3.26 mm)	6, 8, 11	25 feet to 50 feet (7.62 - 15.24m)





FD120  
FDF120

Language
L1 = English
L2 = French
L4 = Italian
L5 = Spanish
L6 = Portuguese
L7 = Chinese
L8 = Polish
L9 = Dutch
L11 = Turkish

DIESEL Plus Options	
380*	Supply Voltage (380V 50/60Hz)
480*	Supply Voltage (480V 60Hz)
600*	Supply Voltage (600V 60Hz)
COM	Communications Option
CX	Extra Contacts (Two Form-C; Specify Function)
E1	NEMA 3R - Raintight Enclosure
E2	NEMA 4 - Watertight Enclosure
E3	NEMA 12 - Dust Tight Enclosure
E5	NEMA 4X - 304 Stainless Steel
E8	Tropicalization
E9	NEMA 4X - Painted Steel
E10	NEMA 4X - 316 Stainless Steel
EX	Export Crating
F2	Floor Stand - 2 Inch Height **
LO	Powered Louver Contacts - (1.6 Amp Max)
LO+	Powered Louver Contacts - (Up to 8.0 Amp)
LX	Extra Light (Specify Description)
Ni	Ni Cad Batteries
P5	Proof Pressure Switch - ALCO - 19-250 PSI
P7	Low Suction Pressure Switch
P8	Shutdown (Requires P7 Option)
P10	Pressure Transducer - Sea Water
P13	Externally Mounted Pressure Transducer **
R1	Space Heater (120 / 220V)
R2	Space Heater c/w Thermostat
R3	Space Heater c/w Humidistat
R4	Low Room Temperature Switch ***
R5	Space Heater (Internally powered - 120V / 240V)
S1	Fuel Level Switch, 16 Inch
S2	Fuel Level Switch, 45 Inch
S3	Fuel Level Switch, High-Low
USB	Externally Mounted USB Port
X1	Printer
X2	4 Inch Chart Recorder (10 - 300 psi fresh water)

Note: All controllers are factory set for 12Vdc operation, unless otherwise noted on the purchase order.  
 \* Standard voltage supplied: 110 / 220V 50/60Hz  
 \*\* Not available for NEMA 4 or NEMA 4X units.  
 \*\*\* When ordered with a NEMA4 / 4X enclosure, the temperature switch is shipped loose with 20 feet of wire.

April 2015

## Diesel Plus Fire Pump Controllers

### Typical Specifications

#### 1. Approvals

- A. The Fire Pump Controller shall meet Factory Mutual Research (FM) 1321/1323. It shall be listed by [Underwriters Laboratories (UL)], [Canadian Standards Association (CSA)], [New York Department of Buildings (NYSB)] for fire pump service.
- B. The controller shall be [12 volt / 24 volt] negative ground, for use with Diesel Engine, Model manufactured by \_\_\_\_\_.

#### 2. Construction

- A. All internal components shall be front mounted and wired for ease of inspection and maintenance. All relays shall have visual indication to show that the relays are energized. The controller shall include an LCD display to indicate battery voltage and amperes as well as system pressure, in PSI or Bars.
- B. The controller shall have twin battery chargers meeting Factory Mutual Research (FM) requirements. The battery chargers shall have reverse polarity protection/ indication and be capable of recharging a completely discharged battery within 24 hours. The chargers shall auto detect the input voltage of 100VAC to 240VAC and shall be able to be programmed for either 12VDC or 24VDC output.
- C. The controller shall come standard with a breaker disconnect on the AC line and for both battery connections.

#### 3. Pressure Sensor

- A. A solid-state 4-20mA pressure sensor shall be provided. The pressure Start and Stop points shall be adjustable in increments of one (1) PSI. A low pressure pre-alarm, indicated with a flashing green LED, shall denote a potential pump starting condition and will remain lit once the pump has started to indicate the starting cause.

#### 4. Output Relays

- A. Two (2) sets of alarm contacts (Form-C) rated at 8A, 250VAC/30VDC, shall be provided for remote indication of:
  1. ENGINE RUN (10A)
  2. LOW FUEL
  3. AUTO MODE
  4. COMMON ALARM
- B. Two (2) 'FUTURE' relays, each containing two sets of alarm contacts (Form-C) shall be provided. Relays can be factory set to indicate a specific alarm and shall be field programmable / adjustable to meet future site requirements:
- C. The Common Alarm relay shall be energized under normal conditions.

#### 5. Enclosure

- A. The controller shall be housed in a NEMA Type 2 (IEC IP11) drip-proof, powder baked finish, freestanding enclosure.
- B. Optional Enclosures:
  1. NEMA 3R (IEC IP24) rain-tight enclosure.
  2. NEMA 4 (IEC IP66) watertight enclosure.
  3. NEMA 4X (IEC IP66) watertight 304 stainless steel enclosure.
  4. NEMA 4X (IEC IP66) watertight 316 stainless steel enclosure.
  5. NEMA 4X (IEC IP66) watertight corrosion resistant enclosure.
  6. NEMA 12 (IEC IP54) dust-tight enclosure.

#### 6. Microprocessor Control

- A. The following parameters shall be programmable and included as standard:
  1. START and STOP PSI points
  2. High and Low Pressure Alarm Setpoints
  3. STOP MODE: Manual or Auto
  4. RUN PERIOD TIMER: 0-60 min
  5. AC POWER FAILURE: Enable or Disable
  6. SEQUENTIAL START TIMER: 0-300 sec.
  7. WEEKLY TEST TIMER
  8. PRESSURE DEVIATION: 1-99 PSI
  9. LANGUAGE: English/French/Spanish/Other
- B. The following visual and audible alarms shall be provided:
  - FAIL TO START
  - LOW OIL PRESSURE
  - ENGINE OVERSPEED
  - BATTERY #1 FAILURE
  - BATTERY #2 FAILURE
  - REMOTE START
  - LOW PRESSURE
  - SPEED SWITCH FAULT
  - ECM SELECTOR IN ALT POSITION
  - FUEL INJECTOR MALFUNCTION
  - STARTER #1 FAILURE
  - STARTER #2 FAILURE
  - TRANSDUCER FAILURE
  - DATA CABLE DISCONNECT
  - DC FAIL
  - HIGH ENGINE TEMP.
  - ENGINE RUN
  - LOW FUEL
  - CHARGER #1 FAILURE
  - CHARGER #2 FAILURE
  - DELUGE VALVE
  - INTERLOCK ON
  - LOW SUCTION
  - ECM WARNING
  - ECM FAILURE
  - HIGH RAW WATER TEMPERATURE
  - LOW ENGINE TEMPERATURE
  - LOW RAW WATER FLOW
  - FUEL SPILL

April 2015

**Diesel Plus Fire Pump Controllers**

- C. The controller shall have a 4 line by 40 character LCD display mounted on a panel opening in the front door. The LCD display shall indicate the following:
  - 1. Main screen displaying system pressure, Battery #1/#2 voltage and amperage, operation mode, shutdown mode, custom messages, alarms, timers, date, and time.
  - 2. Set point review screen displaying the programmed pressure start and stop points, and weekly test time.
  - 3. Controller statistics screen, including:
    - a. Powered Time
    - b. Engine Run Time
    - c. Number of Cranks
    - d. Number of Starts
    - e. Last Engine Start Time
    - f. Last Engine Run Time
    - g. Last Low Pressure Start
    - h. Minimum Battery #1 Voltage
    - i. Maximum Battery #1 Voltage
    - j. Minimum Battery #2 Voltage
    - k. Maximum Battery #2 Voltage
    - l. Minimum Battery #1 Amps
    - m. Maximum Battery #1 Amps
    - n. Minimum Battery #2 Amps
    - o. Maximum Battery #2 Amps
    - p. Minimum System Pressure
    - q. Maximum System Pressure
    - r. Last System Startup
    - s. Last Engine Test
    - t. Last Low Oil Pressure
    - u. Last Overspeed
    - v. Last Fail To Start
    - w. Last Low Fuel
    - x. Last Charger Failure
    - y. Last Battery Failure
    - z. Last ECM Alarm
  - 4. Controller diagnostics screen, including:
    - a. Date & Time
    - b. Firmware Version
    - c. Shop Order Number
    - d. Customer Order Number
    - e. Battery Voltage
    - f. Internal Board Voltage
    - g. Transformer Output Voltage
    - h. Current Transformer Outputs
    - i. Pressure Transducer Calibrated Settings
    - j. Input Status
    - k. Relay Status
  - 5. Display last messages screen that will display at least the last 10,000 alarms / messages stored in the controllers' memory.
  - 6. Display up to ten (10) custom messages of up to 100 characters each, which will continually scroll across the fourth line of the display.
  - 7. Remaining time left on active timers.
- D. The controller shall be supplied with six (6) green status LED's for the following:
  - 1. Engine Run
  - 2. Remote Start
  - 3. Low Pressure
  - 4. Interlock On
  - 5. Deluge Valve
  - 6. One Programmable LED
- E. The controller shall be supplied with twenty (20) red alarm LED's to indicate the following:
  - 1. BATTERY #1 FAILURE
  - 2. BATTERY #2 FAILURE
  - 3. CHARGER #1 FAILURE
  - 4. CHARGER #2 FAILURE
  - 5. SPEED SWITCH FAULT
  - 6. ECM SELECTOR IN ALT POSITION
  - 7. FUEL INJECTION MALFUNCTION
  - 8. LOW SUCTION PRESSURE
  - 9. FAIL TO START
  - 10. HIGH ENGINE TEMP.
  - 11. LOW OIL PRESSURE
  - 12. ENGINE OVERSPEED
  - 13. LOW FUEL
  - 14. ECM WARNING
  - 15. ECM FAILURE
  - 16. HIGH RAW WATER TEMPERATURE
  - 17. LOW ENGINE TEMPERATURE
  - 18. LOW RAW WATER FLOW
  - 19. FUEL SPILL
  - 20. One Programmable LED
- F. The microprocessor logic board shall be available with:
  - 1. A USB port for transference of message history, controller status, diagnostics, configuration, statistics and the ability to update firmware.
  - 2. An optional Ethernet port for direct connection to a computer for data transfer.
  - 3. An optional RS485 Serial port for communication to various external software programs.
  - 4. An optional RS232 Serial Port
- G. The controller shall come complete with an embedded web page which allows viewing of the controllers' current status, data values, programmed set points, and downloadable history.
- H. A Fail-to-Start alarm shall occur if the engine does not start after the crank cycle.
- I. A sequential start timer, weekly test timer and AC Failure Start timer shall be provided as standard.
- J. The controller shall be supplied with interlock and shutdown circuits as standard. A flashing green LED shall indicate an interlock on condition.

April 2015

## **Diesel Plus Fire Pump Controllers**

- K. Where shutdown of the pump(s) due to low suction pressure is required, it shall be accomplished without the addition of a separate panel or enclosure. The LCD display shall indicate low suction shutdown. Resetting of the condition shall be automatic or manual as selected by the user.
- L. Means shall be provided to test the operation of all LED's to ensure their functionality.

### **7. Programming Menu**

- A. The programming menu shall have the ability to enable an entry password.
- B. The programming menu shall be limited to two (2) levels of password protection.
- C. The controller shall have three (3) languages as a standard, English, French, and Spanish, with the ability to add a fourth language.
- D. The programming menu shall be grouped into 7 main menu headings as follows:
  - 1. Regional Settings
  - 2. Pressure Settings
  - 3. Timer Values
  - 4. Input/Output Menu
  - 5. System Configuration (password protected)
  - 6. Language
  - 7. Main Menu Password

### **8. Custom Inputs/Outputs**

- A. The controller shall come standard with nine (9) custom inputs, two (2) programmable LED indicators, and two (2) future outputs, with the ability to add up to another 8 outputs via optional relay boards.
- B. The user shall be able to program the future inputs/outputs and optional relays through the main programming menu.
- C. The inputs shall be selectable based on the following criteria:
  - 1. User selected message or twenty four (24) predetermined messages.
  - 2. Energize the common alarm relay when the input is received.
  - 3. Link to a future relay and/or LED indicator.
  - 4. Alarm latched until reset.
  - 5. Normally open or closed input.
  - 6. On-delay timer.
  - 7. Energize the buzzer when the input is received.
- D. The LED indicators shall be selectable based on the following criteria:
  - Indication based on a minimum of fourteen (14) predetermined alarms or a custom input.

- E. The future relays shall be selectable based on the following criteria:
  - 1. Output based on a minimum of forty (40) predetermined alarms, controller status or a custom input.
  - 2. Latched until reset.
  - 3. Energized under normal conditions.
  - 4. On or off delay timer on the output.

### **9. Manufacturer**

- A. The controller shall be microprocessor based as manufactured by Eaton Industries (Canada) Co.

# EATON Diesel Plus Diesel Engine Fire Pump Controller

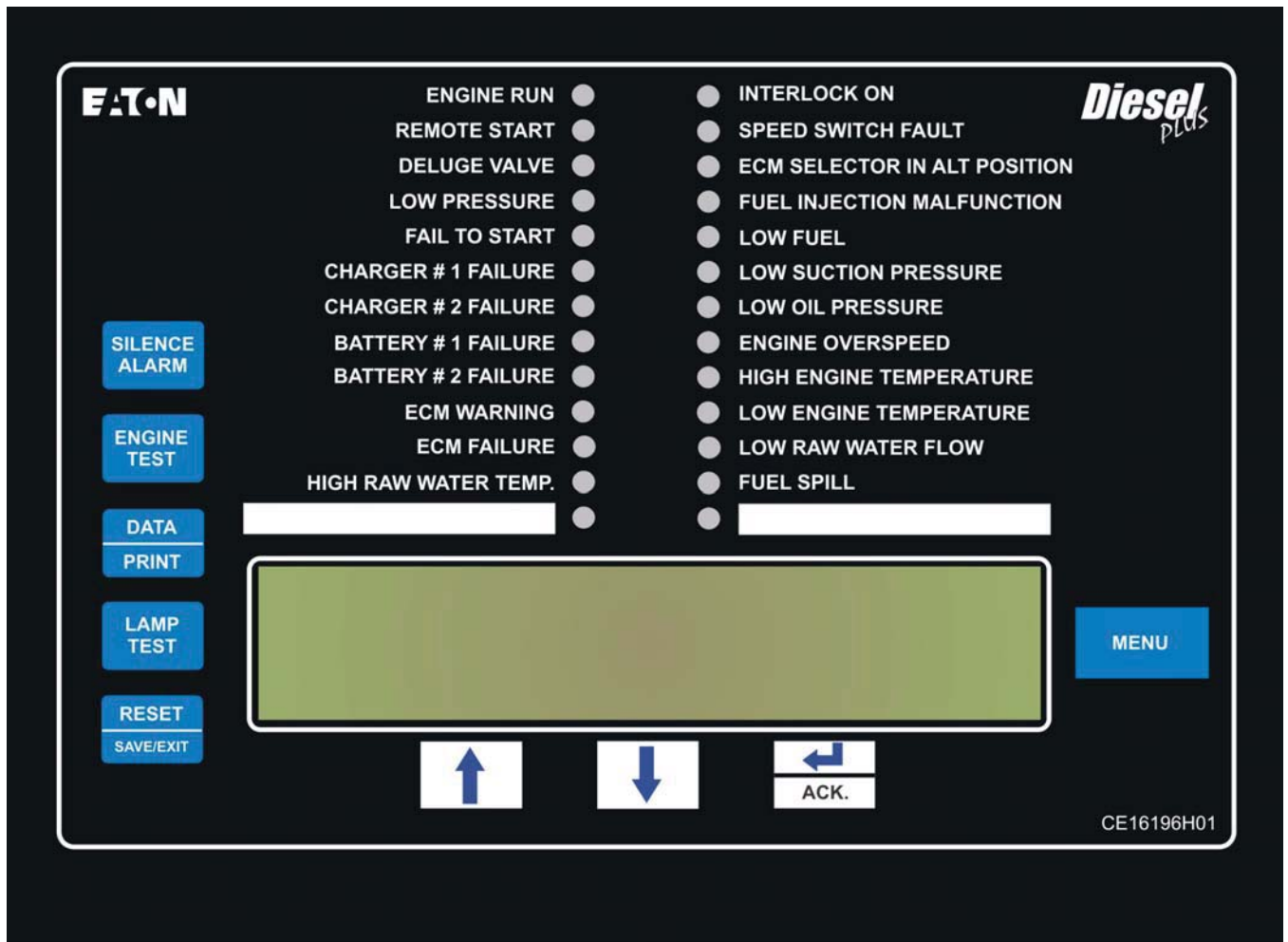

**Contents**

<i>Description</i>	<i>Page</i>	<i>Description</i>	<i>Page</i>
<b>1. INTRODUCTION</b> .....	<b>3</b>	4.4 Output Relays.....	10
1.1 Safety.....	3	4.4.1 Relay Functions .....	10
1.2 Warranty .....	3	4.4.2 Future #1 - Future # 2 .....	10
1.3 Safety Precautions.....	3	4.4.3 Engine Alarm Functions .....	10
1.4 Product Overview .....	3	<b>5. PROGRAMMING</b> .....	<b>10</b>
<b>2. INSTALLATION AND ELECTRICAL CONNECTIONS</b> .....	<b>3</b>	5.1 Introduction .....	10
2.1 Mounting.....	3	5.2 Navigation.....	10
2.2 Pressure Sensor Connections .....	3	<b>6. HISTORY, DIAGNOSTICS, STATISTICS, CONFIGURATION</b> 14	
2.3 Electrical Connections .....	3	6.1 System History .....	14
2.3.1 Wire Sizes .....	4	6.2 Statistics .....	14
2.4 System Pressure Connection.....	4	6.3 Controller Diagnostics.....	15
<b>3. HARDWARE DESCRIPTION</b> .....	<b>4</b>	<b>7. COMMUNICATION</b> .....	<b>15</b>
3.1 General .....	4	7.1 USB .....	15
3.1.1 Battery Chargers .....	4	7.1.1 Information Download .....	15
3.1.2 Three Step Charge.....	4	7.1.2 Custom Message Upload.....	15
3.1.3 Charger Shut Down .....	4	7.1.3 Firmware Update.....	15
3.1.4 AC Input Fuse Protection .....	5	7.1.4 Language Upload .....	15
3.1.5 Battery Charger Display .....	5	7.2 Embedded Webpage (Optional) .....	15
3.1.6 Charger Setup: Lead Acid / NiCad .....	5	7.3 RS485 Serial Port (Optional).....	16
3.1.7 Forced Charging .....	5	7.4 RS232 Serial Port (Optional).....	16
3.1.8 Specifications .....	5	<b>8. CUSTOM MESSAGES</b> .....	<b>16</b>
3.2 Front Operator Panel .....	5	<b>APPENDIX A: MAIN MENU TREE</b> .....	<b>18</b>
3.2.1 The LEDs .....	6	<b>APPENDIX B: REGIONAL SETTINGS MENU TREE</b> .....	<b>19</b>
3.2.2 Pushbuttons .....	7	<b>APPENDIX C: PRESSURE SETTINGS MENU TREE</b> .....	<b>20</b>
3.3 Display Board Access Area .....	7	<b>APPENDIX D: TIMER VALUES MENU TREE</b> .....	<b>21</b>
3.4 Power I/O Board .....	7	<b>APPENDIX E: CUSTOM INPUT/OUTPUT MENU TREE</b> .....	<b>22</b>
3.5 Engine Board.....	7	<b>APPENDIX E(a): CUSTOM INPUTS MENU TREE</b> .....	<b>23</b>
3.6 External Pushbuttons .....	8	<b>APPENDIX E(b): CUSTOM OUTPUTS MENU TREE</b> .....	<b>24</b>
3.6.1 Stop .....	8	<b>APPENDIX E(c): CUSTOM LIGHTS MENU TREE</b> .....	<b>25</b>
<b>4. OPERATION</b> .....	<b>8</b>	<b>APPENDIX F: MAIN MENU PASSWORD MENU TREE</b> .....	<b>26</b>
4.1 General .....	8	<b>APPENDIX G: CUSTOM MESSAGE LOAD &amp; ACTIVATION</b> .....	<b>27</b>
4.2 Start Sequence .....	8	<b>APPENDIX K:</b> .....	<b>28</b>
4.2.1 Manual Start Sequence .....	8	<b>APPENDIX L: ALARM/STATUS MESSAGES</b> .....	<b>29</b>
4.2.2 Automatic Start Sequence .....	8	<b>9. INITIAL START UP</b> .....	<b>30</b>
4.2.3 Run Period Timer .....	9	9.1 Automatic Start Test.....	30
4.2.4 Sequential Start Timer .....	9	9.2 Manual Start Test.....	30
4.3 Program Descriptions .....	9	9.3 Engine Test .....	31
4.3.1 Control Inputs .....	9	9.4 Weekly Exerciser Test .....	31
4.3.2 Control Input Descriptions .....	9		
4.3.3 Loss of DC Power .....	10		
4.3.4 Speed Switch Malfunction .....	10		
4.3.5 Engine Starter Coil Failure .....	10		
4.3.6 Audible Alarm Silencing.....	10		
4.3.7 Power Failure Alarm .....	10		



## 1. INTRODUCTION

### 1.1 Safety

This technical document is intended to cover most aspects associated with the installation, application, operation, and maintenance of the Diesel Plus Fire Pump Controller. It is provided as a guide for authorized and qualified personnel only in the selection and application of the Diesel Plus Controller. If further information is required by the purchaser regarding particular installation, application, or maintenance activity, please contact an authorized EATON sales agent or the installing contractor.

### 1.2 Warranty

No warranties, expressed or implied, including warranties of fitness for a particular purpose of merchantability, or warranties arising from course of dealing or usage of trade, are made regarding the information, recommendations and descriptions contained herein. In no event will EATON be responsible to the purchaser or user in contract, in tort (including negligence), strict liability or otherwise for any special, indirect, incidental or consequential damage or loss whatsoever, including but not limited to damage or loss of use of equipment, plant or power system, cost of capital, loss of power, additional expenses in the use of existing power facilities, or claims against the purchaser or user by its customers resulting from the use of the information and descriptions contained herein.

### 1.3 Safety Precautions

All safety codes, safety standards, and/or regulations must be strictly observed in the installation, operation, and maintenance of this device.



COMPLETELY READ AND UNDERSTAND THE MATERIAL PRESENTED IN THIS DOCUMENT BEFORE ATTEMPTING INSTALLATION, OPERATION, OR APPLICATION OF THE EQUIPMENT. IN ADDITION, ONLY QUALIFIED PERSONS SHOULD BE PERMITTED TO PERFORM ANY WORK ASSOCIATED WITH THIS EQUIPMENT. ANY WIRING INSTRUCTIONS PRESENTED IN THIS DOCUMENT MUST BE FOLLOWED PRECISELY. FAILURE TO DO SO COULD CAUSE PERMANENT EQUIPMENT DAMAGE.

---

### 1.4 Product Overview

The Diesel Plus Controller is a comprehensive, multi-function microprocessor based Fire Pump Controller.

## 2. INSTALLATION AND ELECTRICAL CONNECTIONS

### 2.1 Mounting

Carefully unpack the controller and inspect thoroughly.

The Diesel Plus controller is designed for either wall or floor mounting. Note that the controller is not free standing and must be mounted with feet or bolted securely to a wall. For dimensional and weight data please refer to the respective data sheets for the various types of Diesel Engine Fire Pump Controllers.

### 2.2 Pressure Sensor Connections

The Diesel Plus is equipped with a pressure sensor. The controller is provided with a 1/4" NPT female system pressure connection located on the bottom, external side of the enclosure. The connection should be installed as per NFPA, 20.

The pressure sensor and internal plumbing components are rated for a maximum of 500 PSI.

### 2.3 Electrical Connections

---

#### NOTICE

---

ALL CONDUIT CONNECTIONS TO THE CONTROLLER ARE RECOMMENDED TO BE INSTALLED ON THE BOTTOM OR LOWER RIGHT SIDE OF THE CONTROLLER. REFER TO THE ASSOCIATED DIMENSIONAL DRAWING FOR REFERENCE. DRILLING OR INSTALLING CONDUIT ABOVE THE MICROPROCESSOR BOARDS WILL VOID WARRANTY.

---

All electrical connections should meet national and local electrical codes and standards.

The controller should be located or so protected that it will not be damaged by water escaping from pumps or pump connections. Current carrying parts of controllers shall be a minimum of 12 inches (305 mm) above the floor.

Prior to starting, verify all data on the nameplate such as: catalog number and AC line voltage.

Inspect all electrical connections, components, and wiring for any visible damage. Correct as necessary. Ensure that all electrical connections are tightened before energization.

Refer to the appropriate field connection drawing affixed to the enclosure door, for all wiring information pertaining to the incoming AC power supply, batteries and engine wiring.

Terminals 1 through 12, 301, 302, 303, 304, 310, 311, 312 located on the lower terminal block, are for interconnection to the respective terminals on the diesel engine terminal block.

Incoming AC line voltage is clearly marked L, N and G (ground) located on the lower terminal block.

Install necessary conduit using proper methods and tools.

Terminals 11 through 34, located on the customer connections side of the I/O board are for connecting various input devices to the Diesel Plus. The customer Input terminals on the I/O board are designed to be used with dry (voltage free) contacts.



**⚠ CAUTION**

Do not apply an AC voltage to these terminals.

Terminals 60 through 95, located on the I/O Board, are for connection of all output relay functions.

**NOTE**

All field connections and AC wiring must be brought into the enclosure through the lower right or bottom right side ONLY (refer to labels affixed inside enclosure).

*\*OTHERWISE WARRANTY IS VOID.\**

**2.3.1 Wire Sizes**

For control wiring, use #14 AWG wire for all electrical connections.

For power wiring sizes refer to Appendix K.

**2.4 System Pressure Connection**

The FD120 is supplied with a Pressure Sensor, or as an option, a Pressure Switch.

The "TEST" drain connection, located to the left of the system pressure connection, should be piped to a drain or to waste.

**NOTE**

Water lines to the drain valve and pressure switch must be free from dirt and contamination.

The main controller panel interfaces with either the pressure sensor or the optional pressure switch. The controller must be programmed for the appropriate device.

Using the standard pressure sensor, the actual pressure is displayed on the top left hand corner of the LCD display. Precise start and stop pressure set points can be programmed into the controller via the membrane keypad. Pressure readings are also recorded in the memory during alarm situations or pressure deviations.

With the Pressure Switch option, the LCD will display "OK" if the pressure is satisfied, and "LOW" if the contacts on the pressure switch change state. The message history will record "Low Pressure" when the pressure drops below the set point.

**3. HARDWARE DESCRIPTION****3.1 General**

The purpose of this section is to familiarize the reader with the Diesel Plus Controller hardware, its nomenclature, and to list the unit's specifications.

**3.1.1 Battery Chargers**

Battery chargers are independent of each other and produce a maximum of 10 amps each at full rate. Each battery charger is fully electronic and will protect itself by shutting down during a short circuit condition.

The maximum current draw that the chargers will draw when operating at 100% charging rate is:

12 Volt System	24 Volt System
1.6 amps - 120V	3.2 amps - 120V
0.8 amps - 240V	1.6 amps - 240V

**3.1.2 Three Step Charge**

The battery chargers incorporate a three step charge to guarantee the fastest charge times while optimizing battery life.

The three steps are referred to as Bulk mode, Overcharge Mode and Float mode.

**Bulk**

In Bulk mode, a current of 10 Amps is delivered into the battery until the voltage reaches 2.4 Volts per cell for Lead Acid Batteries. (14.4 Volts for a 12 Volt battery). At this point, the battery has recovered approximately 90% of its capacity.

When the charger senses this state, it switches to the Overcharge mode.

The bulk mode charging may take up to 24 hours depending on the battery capacity and the level to which it was discharged. The charge mode is recorded in the Diesel Plus message history.

**Overcharge**

In the Overcharge mode, the voltage on the battery is held at 14.4 Volts and the current into the battery declines. This mode is maintained until the current into the battery declines to 1.5 Amps. At this moment, the battery is approximately 99% charged and the charger will change to Float Mode.

The overcharge mode charging may take up to 12 hours depending on the battery capacity and the level to which it was discharged. The charge mode is recorded in the Diesel Plus message history.

**Float**

In Float Mode, the charger maintains the battery voltage at 13.3 Volts per cell for a lead acid battery (13.4 Volts for a 12 Volt battery). Once Bulk and Overcharge modes are completed, the charger will maintain the battery charge in Float mode by regulating to 13.3V. If the charger cannot maintain the battery capacity while in Float mode, the charger will begin a new charging sequence by entering Bulk mode.

**3.1.3 Charger Shut Down**

The charger will automatically shut down if there is no load connected to the output or if there is a short on the load side of the charger. In addition, the charger will not operate if a battery is connected incorrectly or if the wrong voltage of battery is connected.

### 3.1.4 AC Input Fuse Protection

The AC Supply is protected by a 6 amp fuse which will blow in case of a breakdown of the charger. This fuse will not blow as a result of overloading of the charger since the electronics will shutdown the charger in this event before the fuse blows. If this fuse is blown the charger must be replaced.

### 3.1.5 Battery Charger Display

The Diesel Plus chargers history will display Charging Voltage and Amperage as well as error messages. The following will be recorded according to the conditions that exist.

“NO BATTERY” is displayed if no battery is attached to the charger.

“BATTERY ERROR” is displayed if a battery is connected to the charger but the voltage is not within the minimum and maximum thresholds for the selected battery type.

“ERROR, RECOVERING” is displayed if the maximum battery charger output voltage (31.4V) has been exceeded.

### 3.1.6 Charger Setup: Lead Acid / NiCad

DIP switches on the charger can be used to select a number of options including battery type and voltage as well as Forced Charging. Options currently supported for the charger include 12 or 24 Volt Lead Acid and NiCad Batteries.

#### Lead Acid

To select 12 Volt battery charge cycle with Lead Acid batteries set all DIP switches to the OFF position.

#### 12 Volt - Lead Acid

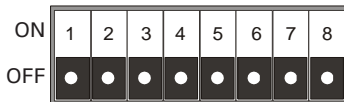

To select 24 Volt battery charger cycle with Lead Acid batteries, set DIP switch 3 to the ON position and all other DIP switches to the OFF position.

#### 24 Volt - Lead Acid

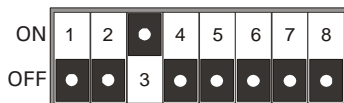

#### NiCad

To select 12 Volt battery charger with NiCad batteries, set DIP switch 6 to the ON position and all other DIP switches to the OFF position.

#### 12 Volt - NiCad

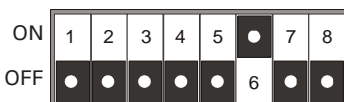

To select 24 Volt battery charger cycle with NiCad batteries, set DIP switches 3 and 6 to the ON position and all other DIP switches to the OFF position.

#### 24 Volt - NiCad

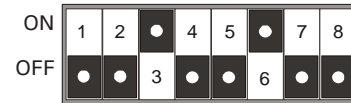

### 3.1.7 Forced Charging

There is provision for the battery chargers to provide a forced charge to the batteries. The Forced Charge function will only activate immediately after applying power to the charger with DIP Switch 8 in the ON position and a battery connected.

When the charger is in the forced charge mode, it will attempt to recover a battery by delivering 10 amps. If the battery does not reach the minimum battery voltage (8 volts for a 12 volt system; 16 volts for a 24 volt system) within 5 minutes, the recovery attempt will terminate. Once the battery reaches its minimum battery voltage, the normal charge sequence will commence.

Forced charging will only occur once per battery charger power cycle.

#### 12 Volt - Lead Acid



#### 12 Volt - NiCad



#### 24 Volt - Lead Acid

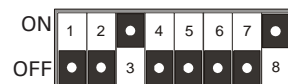

#### 24 Volt - NiCad



#### NOTE

When installing a replacement charger in controllers prior to the Diesel Plus – DIP Switch number 5 must be switched to the ON position.

### 3.1.8 Specifications

Voltage Input: 120 - 240VAC - Auto detect  
 Voltage Output: 12-24VDC-DIP switch selectable  
 Hertz: Operates on 50 / 60Hz

### 3.2 Front Operator Panel

The front operator panel, is normally accessible from the outside of the door. The front panel provides a means to:

- Alert the user to specific conditions
- Program the controller
- Set and monitor the operating parameters
- Perform a manual start of the controller.

The Diesel Plus Controller front panel serves two primary functions: output and input. The output function consists of:

- A four-line, 40 character LCD display module
- Twenty Four LED outputs:
 

Engine Run	Interlock On
Remote Start	Speed Switch Fault
Deluge Valve	ECM Selector in Alt. Position
Low Pressure	Fuel Injection Malfunction
Fail to Start	Low Fuel
Charger #1 Failure	Low Suction Pressure
Charger #2 Failure	Low Oil Pressure
Battery #1 Failure	Engine Overspeed
Battery #2 Failure	High Engine Temperature
ECM Warning	Low Engine Temperature
ECM Failure	Low Raw Water Flow
High Raw Water Temp.	Fuel Spill
- Two (2) user defined LEDs.

There are nine input functions accessible via the pushbuttons:

- Silence Alarm
- Engine Test
- Data | Print
- Lamp Test
- Reset | Save/Exit
- Up
- Down
- Ack. Alarm
- Menu

A four-line, 40-character alphanumeric LCD Display module is used to display all Diesel Plus monitored parameters, set points, and messages in easy to read formats. The display has a green high contrast background that allows clear visibility of any information displayed. The display is continuously lit for clear visibility under poorly lit or no light conditions.

Seven different displays can be presented via the LCD display:

- Status Display
- Set Points Display
- Statistics Display
- Diagnostics Display
- History Display
- Data/Print Display
- Message History Display

The "Home" screen display will show the current date and time, current pressure, Battery #1 voltage and charging amps,

Battery #2 voltage and charging amps and whether Automatic Shutdown is in ON or OFF mode.

The fourth line of the display indicates the time remaining on any active timers, alarms without an associated LED, and custom messages.

### 3.2.1 The LEDs

- **Engine Run** - This green LED will be illuminated when there is an Engine Run signal from the engine.
- **Remote Start** - This green LED will be illuminated after receiving a start signal on the remote start input. (Terminals 11 and 34)
- **Deluge Valve** - This green LED will be illuminated after receiving a start signal from special starting equipment. This is a normally closed contact that is required to be opened to start. A factory installed jumper wire must be removed to use these contacts. (Terminals 11 and 35)
- **Low Pressure** - This green LED will flash when the system pressure has dropped below the programmed low pressure alarm set point. This LED will be fully illuminated when the pressure falls below the pressure start point.
- **Fail to Start** - This red LED will be illuminated if the controller has not received an engine run signal from the engine after attempting to crank the engine a total of 6 times
- **Battery # 1 Failure** - This red LED will be illuminated during the cranking cycle when the controller detects a weak or discharged battery, i.e. 67% of rated voltage, or less, or whenever a battery cable is disconnected.
- **Battery # 2 Failure** - This red LED will be illuminated during the cranking cycle when the controller detects a weak or discharged battery, i.e. 67% of rated voltage, or less, or whenever a battery cable is disconnected.
- **Charger # 1 Failure** - This red LED will be illuminated when the supply power to the charger is lost or when the charger malfunctions. The engine continues to run. To avoid nuisance alarms, the AC Power Failure Alarm set point can be increased.
- **Charger # 2 Failure** - This red LED will be illuminated when the supply power to the charger is lost or when the charger malfunctions. The engine continues to run. To avoid nuisance alarms, the AC Power Failure Alarm set point can be increased.
- **Interlock On** - This green LED will flash when the interlock input is received, signaling that another controller or device has locked out the controller. (Terminals 11 and 39)
- **Speed Switch Fault** - This red LED will be illuminated if the controller is running, the engine run signal is lost and the oil pressure does not drop. (Terminals 2 and 4)
- **ECM Selector in Alt. Position** - This red LED will be illuminated when the controller receives a signal from the engine indicating the engine is running on the alternate ECM. (Terminal 301)
- **Fuel Injection Malfunction** - This red LED will be illuminated when the controller receives a signal from the engine indicating there is a fuel injection malfunction. (Terminal 302)

- **Low Fuel** - This red LED will be illuminated when the controller receives a signal from the fuel level switch indicating there is low fuel. (Terminals 11 and 38)
- **Low Suction Pressure/Low Foam Level** - This red LED will illuminate when a low suction pressure signal has been received. A low suction pressure switch can be added to the controller as option P7. (Terminals 11 and 37)
- **Low Oil Pressure** - This red LED will be illuminated when the controller receives a signal from the engine indicating there is low oil pressure. (Terminal 4)
- **Engine Overspeed** - This red LED will be illuminated when the controller receives a signal from the engine indicating there is an engine overspeed condition. (Terminal 3)
- **High Engine Temperature** - This red LED will be illuminated when the controller receives a signal from the engine indicating there is high engine temperature. (Terminal 5)
- **Electronic Control Module Warning** - This red LED will be illuminated when the controller receives an Electronic Control Module Warning signal from the engine. (Terminal 303)
- **Electronic Control Module Failure** - This red LED will be illuminated when the controller receives an Electronic Control Module Failure signal from the engine. (Terminal 304)
- **High Raw Water Temperature** - This red LED will be illuminated when the controller receives a High Raw Water Temperature signal from the engine. (Terminal 310)
- **Low Raw Water Flow** - This red LED will be illuminated when the controller receives a Low Raw Water Flow signal from the engine. (Terminal 311)
- **Low Engine Temperature** - This red LED will be illuminated when the controller receives a Low Engine Temperature signal from the. (Terminal 312)
- **Fuel Spill** - This red LED will be illuminated when the controller receives a contact closure from the fuel tank sensor. (Terminal 40)

### 3.2.2 Pushbuttons

- **Data | Print** - The data, print button allows the user to enter a multi-task menu where they can initiate the download of the message history, system diagnostics, system configuration to an external USB drive, upload custom messages, and an additional language. If the optional printer (X1) is included with the controller, the user will be able to initiate a print cycle through this menu list.
- **Lamp Test** - The lamp test button allows the user to test all of the LED's on the operator panel. Pressing and holding this button will illuminate each LED on the operator panel in successive steps.
- **Reset | Save/Exit** - The reset/save/exit button serves two functions. Pressing the reset button will reset most alarms that are present on the controller at that time. If the alarm condition still exists it will alarm again. When the user is in the programming mode, pressing the save/exit button will save all of the user adjusted values and make the recent changes active.

- **↑** - The up arrow is used to navigate the main display as well as the menu systems.
- **↓** - The down arrow is used to navigate the main display as well as the menu systems.
- **↵ | Ack.** - The enter and acknowledge button serves two functions. When navigating the main display, the enter button will allow the user to enter/exit the message history, statistics, and diagnostics. When in the menu system, the enter button will allow the user to change the programmed set points, and navigate to the next menu item.
- **Menu** - Pressing the menu will allow the user access to the programming mode of the controller. When in the programming mode, the menu button will serve as a back button in most cases to return to the previous menu heading.

### 3.3 Display Board Access Area

The display board is housed in a protective case that is mounted on the inside of the controller door. Access to communication ports and terminals is possible when the controller door is open.

#### NOTE

To allow for uniform identification, the frame of reference when discussing the access area is with the panel door open and the user facing the back of the Diesel Plus controller.

Located on the bottom of the chassis is the optional USB port, the optional Ethernet port, the I/O board communication and power cables. The optional RS232 and RS-485 ports are located on the right hand side of the chassis.

The display contrast adjustments can be made via the open potentiometer dial in the back of the chassis.

### 3.4 Power I/O Board

The I/O Board is used for connecting all alarm input and output signals. Optional relay expansion boards may also be connected to the I/O board.

Refer to the Field Connection diagram mounted on the inside of the controller door for all connection points specific to the controller.

### 3.5 Engine Board

The Diesel Engine Board houses terminals 1 through 12, 301, 302, 303, 304, 310, 311, 312 used to connect to the engine control panel, as well as the incoming AC Power terminals (L, N, G).

Also located on the engine board, are the Crank relays (8CR and 9CR), the Fuel Stop relay (7CR), the DC breaker switches (CB1 and CB2) and main AC power switch.

## 3.6 External Pushbuttons

### 3.6.1 Stop

The stop pushbutton will initiate the stopping sequence of the fire pump engine only if no starting conditions are present. Pressing the stop button will not change the mode the panel was in when the button was pressed.

## 4. OPERATION

### 4.1 General

This section specifically describes the operation and functional use of the Diesel Plus controller. The practical use of and operation within each category will be discussed. In this section, it is assumed that prior sections of this manual were reviewed and that the operator has a basic understanding of the hardware.

### 4.2 Start Sequence

In the Automatic Mode the Diesel Plus controller will automatically start and stop the fire pump motor as dictated by the features supplied and their programmed set-point values. A summary of the controller intelligence and supervisory circuits that constantly monitor the condition of the system pressure, inputs, and system alarm points is provided.

#### 4.2.1 Manual Start Sequence

Manual start is defined as a remote start. Whenever the engine is running via a manual start, the motor needs to be manually stopped via the stop pushbutton located on the enclosure flange or by placing the controller in off mode.

#### 4.2.2 Automatic Start Sequence

Automatic start is defined as a low-pressure pump start contact closure, and Deluge Valve start condition. (Terminals 11 and 36) Whenever the engine is running via an automatic start the engine can be automatically stopped. In order for the controller to automatically stop the engine automatic stopping must be enabled, the RPT must be finished its timing cycle and no starting conditions can exist. If the controller is programmed for automatic shutdown, the motor needs to be manually stopped via the local stop pushbutton located on the enclosure flange or by placing the controller in the off mode.

#### OFF Mode

In the OFF position the controller will not attempt to start the engine for any reason. Off mode also resets and silences all alarms.

#### MANUAL Mode

This position allows the starting of the engines using the manual crank buttons, Crank #1 and Crank #2, are located on the enclosure flange. For added cranking capacity, both Crank buttons can be depressed simultaneously.

The engine can be stopped by the "Local Stop" pushbutton or by placing the controller in the OFF mode. The engine will automatically stop in the case of an OVERSPEED condition.

All alarms, except for "FAIL TO START", are active in the MANUAL mode.



### CAUTION

Only depress Crank #1 or Crank #2 pushbuttons with controller in the "MANUAL" mode.

Do not depress the crank pushbuttons in any other mode or while engine is running. Doing so can result in serious damage to the engine.

#### AUTO Mode

A drop in pressure, "Remote Start" signal, "Pump Start" signal, a signal from the "Deluge Valve" or Weekly Test Timer will initiate the "attempt to start" cycle. This cycle consists of 6 crank periods of 15 seconds duration separated by 5 rest periods of 15 seconds duration. Battery 1 and Battery 2 are alternated for each crank cycle. In the event that one battery is inoperative or missing, the controller will lock-in on the remaining battery during the cranking sequence. Once the engine is running, the controller will stop all further cranking.

#### STOP Modes

The Stop Mode is programmable for Auto Shutdown - On or Off (see Appendix C). Note that the engine can be stopped in many cases by pressing the local stop push button or at any time by placing the controller in the OFF position or automatically in case of an OVERSPEED condition.

**Manual Stop Mode:** The engine will continue to run until the "Local Stop" pushbutton is depressed - providing all starting causes have been eliminated.

**Auto Shutdown:** The engine will continue to run until the running period timer (RPT) has timed out and all starting causes have been eliminated.

#### Weekly Test Timer

Each Diesel Plus controller is equipped with a Weekly Test Timer, to automatically exercise the engine in one week intervals, based on the programmed setting. The controller initiates the starting sequence by opening a drain valve resulting in a simulated system pressure loss. The drain valve is automatically closed once the controller receives a Low Pressure signal. The engine will continue to run for the programmed duration. "Weekly Test Started" will be saved into the controller memory.

In order to protect the engine, during the Weekly Test sequence, an OVERSPEED condition, LOW OIL PRESSURE or HIGH ENGINE TEMP alarm will automatically shutdown the engine.

#### Engine Test Pushbutton

Pressing the Engine Test pushbutton initiates a starting sequence by opening the drain valve resulting in a pressure loss. The controller will start the engine in the automatic mode.

The TEST sequence can be terminated by putting the controller in the OFF mode, otherwise the STOP mode prevails as programmed.

All alarms are active in the test mode. In order to protect the engine, in the test mode, an OVERSPEED condition, LOW OIL PRESSURE or HIGH ENGINE TEMP alarm will automatically shutdown the engine.



### 4.2.3 Run Period Timer

The RPT is only active when active when the auto stop is set to "On". The Run Period Timer (RPT) performs the automatic stopping function in the controller. After a start initiated by the pressure sensor or via the "Pump Start" input the controller will start and run for the duration of the RPT.

The purpose of the RPT is to ensure that the engine is not subjected to frequent starts in response to the pressure. Refer to Appendix D for programming of the RPT.

### 4.2.4 Sequential Start Timer

The Sequential Start Timer is standard in all Diesel Plus fire pump controllers.

The controller for each unit of multiple pump units shall incorporate a sequential timing device to prevent any one driver from starting simultaneously with any other driver. Each pump supplying suction pressure to another pump shall be arranged to start within 10 seconds before the pump it supplies. The controllers for pumps arranged in series shall be interlocked to ensure the correct pump starting sequence. If water requirements call for more than one pumping unit to operate, the units shall start at intervals of 5 to 10 seconds. Failure of a leading driver to start shall not prevent subsequent drivers from starting.

The sequential start timer (SST) delays the starting of a fire pump in response to the pressure sensor or "Pump start" input. It does not delay a "Remote start."

With a SST in each controller, any pump may be selected as the lead pump by appropriate setting of the timers. If the lead pump restores the pressure in less than the time delays applied to the lag pumps, then the lag pumps will not start.

In addition, the provision of a sequential start timer, set to a few seconds delay, will prevent the lead pump controller from responding to momentary hydraulic transient pressure loss which would otherwise start the fire pump unnecessarily.

The SST can be programmed from 0 - 300 seconds. Typically, each pump should be delayed by 10 seconds from the pump ahead of it.

## 4.3 Program Descriptions

Refer to Appendix A attached.

### 4.3.1 Control Inputs

The Diesel Plus has six (6) individual input control signals and nine (9) programmable inputs.



SEVERE DAMAGE COULD BE CAUSED TO THE MICROPROCESSOR BOARDS IF A VOLTAGE IS APPLIED TO THESE INPUTS. THEY ARE INTERNALLY POWERED.

---

### 4.3.2 Control Input Descriptions

The Control Input state definitions are as follows.

**Connected** - When the input is shorted by an external contact or connection.

**Unconnected** - When the input is NOT shorted by an external contact or connection.

The Control Input operations are defined as follows.

---

### NOTE

---

Terminal 11 is common to all of the inputs outlined below.

---

#### Remote Start (Terminal 34)

When this input is in the "Connected" state, the Diesel Plus controller will initiate a manual start sequence. This input is typically wired to a remote pushbutton to allow for remote manual starting of the controller.

#### Deluge Valve (Terminal 35)

When this input is in the "Unconnected" state, the Diesel Plus controller will initiate a manual start sequence. This input is typically wired to remote water control equipment that starts the controller before the pressure sensor does. As this input requires a normally closed contact to open to initiate the start, a jumper is factory installed. The jumper must be removed in order to utilize this optional input.

#### Pump Start (Terminal 36)

When this input is in the "Connected" state, the Diesel Plus controller will initiate an automatic start sequence. This input is typically wired to a separate pressure switch when the use of a pressure sensor is not desired.

---

### NOTE

---

When the controller is programmed for foam operation, the pump start input will be a normally closed input that will open to initiate a start.

---

#### Low Suction/Low Foam Level (Terminal 37)

When this input is in the "Connected" state, the Diesel Plus controller will signal a visual indication on the main display board for Low Suction. If the controller is programmed for Low Suction Shutdown it will initiate the shutdown sequence. Refer to Appendix D to program Low Suction Shutdown. When the controller is setup for a foam system, all references to Low Suction Shutdown will be changed to Low Foam Level.

#### Low Fuel (Terminal 38)

When this input is in the "Connected" state, the Diesel Plus controller will signal an audible and visual indication on the main display board for Low Fuel Level. The Common Alarm relay will also de-energize for remote monitoring of this alarm.

#### Interlock On (Terminal 39)

When this input is in the "Connected" state, the Diesel Plus controller will not permit a start of the motor except in manual mode. This input is typically used in backup style systems. For example, the Engine Running contacts from the backup Diesel Engine Controller are wired into this input. When the Diesel Engine is running, it will lock out the Diesel Plus panel and prevent it from starting.

#### Inputs (1-10)

These are programmable inputs and will function based on how they are programmed. Refer to Appendix E(a) for programming details.

### 4.3.3 Loss of DC Power

A visual indication and audible alarm is provided to indicate DC power loss due to both batteries being disconnected from the controller. This indication will also be provided if the controller is not operating due to an electronic board failure.

### 4.3.4 Speed Switch Malfunction

A visual indication and audible alarm is provided to indicate when the following condition has occurred: The controller is running, the engine run signal has been lost and the oil pressure has not dropped. (Terminals 2 and 4)

### 4.3.5 Engine Starter Coil Failure

The Diesel Plus controller constantly monitors the health of the engine starter solenoids. A visual indication and audible alarm is provided if the Diesel Plus detects that the engine starter solenoid is disconnected or damaged.

### 4.3.6 Audible Alarm Silencing

A separate audible alarm silence switch is provided which can manually silence the alarm buzzer for optional alarms. The silencing switch is located adjacent to the visual indicator.

### 4.3.7 Power Failure Alarm

An alarm signal is provided when both circuit breakers have tripped or been opened.

## 4.4 Output Relays

The primary control outputs of the Diesel Plus controller are dry relay contacts. These relays include 2 separate "Form C" outputs for each of the following: Engine Run, Future #1, Future #2, Low Fuel, Auto Mode and Common Alarm.

The Engine Run relay is UL/CSA rated at 10A, 1/2HP, 240Vac. The remaining alarm relays are UL/CSA rated at 8A, 250Vac. The DC rating is 8A, 30Vdc.

Each relay has a green LED on the I/O board to indicate the relay status.

If the LED is "On" the relay is energized. If the LED is "Off" the relay is de-energized.

### 4.4.1 Relay Functions

#### Engine Run

This relay is used for remote monitoring when the engine is running. When the engine speed switch sends a signal to the Diesel Plus controller, this relay will energize.

#### Common Alarm

This relay is used to signal pump room or engine trouble alarms. This relay is energized under normal conditions and will de-energize during alarm.

#### Low Fuel

This relay is used for remote monitoring of the fuel tank level. When the level switch in the fuel tank falls below its pre-set level, this relay will energize.

### 4.4.2 Future #1 - Future # 2

The two Form C relays can be programmed for a number of alarm or status conditions. Refer to Appendix E(b) for programming details.

### 4.4.3 Engine Alarm Functions

#### Engine Overspeed

An "Engine Overspeed" alarm will shutdown the engine regardless of the start condition - *in all modes*. The signal is sent from the engine to the controller.

#### Fail To Start

After 6 cranking attempts, three attempts per battery, the "Fail To Start" annunciator will illuminate. Attention to the diesel and its associated equipment is required immediately.

#### High Engine Temperature

Indicates that the coolant temperature in the water jackets is extremely hot. The over temperature switch on the engine signals the controller. The engine continues to run in the AUTO and MANUAL modes. During a manual engine test and during the weekly test cycle the engine will shutdown.

#### Low Oil Pressure

The controller has an inherent delay to bypass the low oil pressure alarm during engine start up. After the delay, should the engine receive a "Low Oil Pressure" signal, the controller will initiate an alarm. The engine will continue to run in the "AUTO" and "MANUAL" mode. During a manual engine test and during the weekly test cycle this alarm will automatically shutdown the engine.

#### Low Fuel

*(When Fuel Level Switch Wired)*

Indicates that the engine fuel supply is low. The engine continues to run.

## 5. PROGRAMMING

### 5.1 Introduction

The Diesel Plus controller is fully programmable from the device's faceplate. Users can program set points as well as other parameters. The time, date, and set points can only be changed from the menu system. The menu system is broken down to seven (7) menu groupings. They include, Language, Regional Settings, Pressure Settings, Timer Values, Custom Input/Output, System Configuration Menu, and Main Menu Password.

### 5.2 Navigation

In order to enter the menu system, press the Menu button on the Diesel Plus faceplate. If the main menu password has been enabled, the user will be required to enter the password at this time. Once in the menu system, the Up and Down arrow keys will provide navigation between each menu item. The display will show the previous, current, and next menu items. The current menu item is located on the middle of the four line display. All Diesel Plus controller programmable features and associated set-point possibilities are presented in Table 1.

The following set points are programmable in the Diesel Plus controller.



**Table 1. Programmable Features and Set Points**

Description	Factory Default	Range
Main Program - Appendix A Language - Appendix A Regional Settings - Appendix B	English	English/French/Spanish
Change Date	Current Date	Unlimited
Change Time	Current Time (MST)	24 Hours
Pressure Settings - Appendix C		
Pressure Sensor	Enabled	Enabled/Disabled
Pressure Start Point	100 PSI	0-500 PSI
Pressure Stop Point	110 PSI	0-500 PSI
Low Pressure Alarm Point	105 PSI	0-500 PSI
High Pressure Alarm Point	300 PSI	0-500 PSI
Auto Shutdown	OFF	ON/OFF
Proof Pressure Switch	Disabled	Enabled/Disabled (Foam Only)
Low Suction Shutdown (Foam Level)	Disabled	Disabled/Enabled
Pressure Deviation	10 PSI	1-50 PSI
Hourly Pressure Recording	Disabled	Enabled/Disabled
Timer Values - Appendix D		
Run Period Timer	10 Minutes	0-45 Minutes
RPT Start Mode	Pump Run	Pump Run/Pressure Stop Point
Weekly Test Timer	Disabled	7 Days/24 Hours (1-60 Minutes)
AC Power Failure Alarm	5 Seconds	0-180 Seconds
AC Power Failure Start	Disabled	Disabled/Enabled
Sequential Start Timer	Disabled	Disabled / 1-300 Seconds
Custom Input/Output - Appendix E		
Custom Inputs #1-10	Undefined	Refer to Appendix E(a)
Custom Outputs #1-10	Undefined	Refer to Appendix E(b)
Custom Lights #1-6	Undefined	Refer to Appendix E(c)
Main Menu Password - Appendix F	Disabled	Enabled/Disabled - Any number of four (4) button combinations from keypad

Following is a description of each programmable set point.

**Please Enter Password** - If the password is enabled, the user will be prompted to enter the password at this time. If there are no buttons pressed for five (5) seconds, the controller will switch back to the automatic mode.

**Language** - Three (3) languages are offered as standard. They are English, French, or Spanish. A fourth language can be added utilizing the USB port. Consult Eaton for available languages. Refer to for programming.

**Regional Settings** - Refer to Appendix B. Following are the descriptions of each menu item:

- **Change Date** - Factory set, however, this parameter allows the user to set the current date.
- **Change Time** - Factory set to Mountain Standard Time (MST). This menu item allows the user to adjust the time to the local time. The clock is of the 24-hour type.

**Pressure Settings** - Refer to Appendix C. Following are the descriptions of each menu item:

- **Pressure Sensor** - Some applications do not require a pressure sensor to sense the system pressure in order to start the pump motor when required. The pressure sensor can be disabled through this menu item, in order to accomplish this. Once disabled, the pressure start point, pressure stop point, low pressure alarm, and high pressure alarm set-points will be removed from the menu system.
- **Pressure Start Point** - The value programmed determines at which pressure the controller will initiate a start sequence.
- **Pressure Stop Point** - The value programmed determines the pressure the system must reach before the controller will automatically stop the fire pump motor, via the running period timer. If the system pressure does not exceed the programmed Pressure Stop Point, the fire pump motor will continue to run. (Auto Shutdown must be set to ON)

- **Low Pressure Alarm** - A low pressure alarm point can be selected that will be recorded in the controller's history.
- **High Pressure Alarm** - A high pressure alarm point can be selected that will be recorded in the controller's history.
- **Auto Shutdown** - The stop mode is user selectable. If the shutdown mode is programmed for Off, the engine must be stopped via the local stop pushbutton, whether or not the engine started via an automatic start. If the auto shutdown is programmed for On, the controller will stop the engine automatically after all starting causes have been returned to normal and the run period timer has timed out.
- **Proof Pressure Switch** - When enabled, this contact must be closed to allow starting of the controller via the pump start contact. Additionally, if the pressure transducer is enabled this contact must be closed to allow starting of the controller via pressure drop. This menu item will only be active when the controller is programmed for a Foam Pump Controller.
- **Low Suction Shutdown/Foam Level** - The controller can be programmed to shutdown when a low suction condition is present. If this is desired, the user will select Enabled.

There will also be a shutdown delay timer built in (Range: 0-30 Seconds, Default: 10 Seconds) along with the selection of either a Manual or Automatic reset.

If Manual Reset is selected, the Ack./Alarm button on the keypad must be activated to reset the alarm.

If an Automatic Reset (default reset mode) is selected, a delay timer (Range: 0-30 Seconds, Default: 10 Seconds) must be set. The controller will continually verify if the input is still active. Once the input has been removed, the timer will start timing. Once the timer has finished timing, out the controller will return to the automatic run mode.

When the shutdown delay timer is timing, the time left on the timer will be displayed on the fourth line of the display. When the controller is shutdown on Low Suction, the display will read Low Suction Shutdown. The display will also show the automatic reset time delay when timing. Low Suction Shutdown will not work on Remote Starts.

---

### ATTENTION

---

NFPA 20, SECTION 4.14.9.2(2), SPECIFICALLY PROHIBITS THE INSTALLATION OF ANY DEVICE IN THE SUCTION PIPING THAT WILL RESTRICT STARTING OR STOPPING OF THE FIRE PUMP UNLESS REQUIRED BY THE AHJ. EATON CORPORATION ASSUMES NO LIABILITY WHEN THIS FUNCTION IS USED.

---

- **Pressure Deviation** - A pressure setting may be selected, such that any change in pressure greater than this setting, will record the pressure fluctuation in the message history.
- **Hourly Pressure Recording** - The controller can be set so that it will take a pressure reading every hour on the hour. If this feature is not required it can be disabled by selecting Disabled.

**Timer Values** - Following are the descriptions for each menu item:

- **Run Period Timer (RPT)** - The run period timer is used to automatically stop the engine after a programmed time. It

can be programmed to operate based on either of two separate conditions, the stop pressure point or when the engine has started to run. If the RPT is programmed to start at the Stop Pressure, the timer will start timing once the system pressure has reached the programmed Stop Pressure Point. If the RPT is programmed to start timing once the engine is running, the timer will start timing once the controller has received a running signal. If the Stop Mode is programmed for Manual stop the RPT will not be active. It will not be active on Remote Starts. While it is timing the amount of time left on the timer will be displayed on the fourth line of the display.

- **RPT Start Mode** - The point at which the run period timer starts timing is programmable. If it is programmed to start timing after the engine has started, the RPT will start timing once a signal has been received from the engine speed switch. If it is programmed to start timing once the Stop Pressure Point has been reached, the RPT will start timing when the system pressure has risen above the programmed Pressure Stop Point.
- **Weekly Test Timer** - A Weekly Timer can be programmed that will automatically start and run the fire pump engine. The Weekly Timer is set by adjusting the day, hour, and minute of the desired weekly run time, the length of time that this test shall be performed, and a Test Interval (TI) (Range 1-52 Weeks) that will run the test every TI weeks. While the weekly test timer is timing, the remaining time will be displayed on the fourth line of the display.
- **AC Power Failure Alarm** - This setting is used to delay the AC Power failure alarm. The time can be increased to prevent nuisance alarms caused by short interruptions to the AC power.
- **AC Power Failure Start** - If "Enabled," the controller will automatically start upon the loss of AC power. The start delay is based on the AC Power Failure Alarm delay setting. Time range is between 0 & 300 seconds. If "disabled" AC power failure will have no affect on the starting of the engine.

In order to protect the engine, during the AC Power Failure Start, an OVERSPEED condition, LOW OIL PRESSURE or HIGH ENGINE TEMP alarm will automatically shutdown the engine.

- **Sequential Start Timer (SST)** - The SST can be set to delay the starting of the pump when a low-pressure condition exists. If during the timing of the sequential timer, the pressure rises above the pressure start point, the timer will stop timing and the starting sequence will discontinue. When the SST is timing, the time left will be displayed on the fourth line of the display. The SST will not work on Remote Starts.

**Custom Input/Output** - Refer to Appendix E. Following are the descriptions for each menu item:

**Custom Inputs** - The optional inputs have the ability to be programmed with predetermined values or custom values. The Custom Input Menu will display each input, what it is programmed for and if there are any associated optional relays and / or lights linked to the input. Refer to Table 2 for the generic values the optional inputs can be programmed for. When this input is received a message will be stored in memory using the programmed label.

**Table 2. Generic Custom Input Labels**

Input
Custom Input
Relief Valve Discharge
High Fuel
Jockey Pump Run
Secondary Pump Run
Low Reservoir
High Reservoir
Reservoir Empty
Pump Room Door Open
Supervisory Power Fail
Low Room Temperature
Fuel Spill
Low Hydraulic Pressure
System Overpressure

- **Label** - If the input label is set to Custom Input, this menu item will become active and allow the user to enter the desired input name in. The label will be limited to 20 characters in length and will include all standard ASCII characters.
- **Energize Common Alarm** - If required, the common alarm relay (6CR) can be programmed to change states when this input is received. Default value is Disabled.
- **Link to Relay** - All inputs can be linked to an output relay. If the relay has been linked to another input or is programmed for another alarm, the program will show what the output is programmed for and ask if the relay should be reassigned. Default value is Disabled.
- **Link to Light** - All inputs can be linked to one of the future LED's. If the LED is already linked to another input or is programmed for another alarm, the program will show what the LED is programmed for and ask if the LED should be reassigned. Default value is Disabled.
- **Latched Until Reset** - The alarm signal can be programmed to latch in an on state until the ACK/ALARM or RESET buttons are pressed. In this case if there are any associated relays or LED's linked to the input, they will stay active until the ACK/ALARM or RESET buttons are pressed. Default value is No.
- **Normal Input State** - All inputs can be programmed to operate using a normally open or normally closed or normally closed input. Default value is Open.
- **Timer** - A timer can be programmed to delay the time before the alarm becomes active. Default value is 0 seconds. Range is 0-500 seconds. The timer will reset if the input is removed before the time has timed out.

**Custom Outputs** - The optional output relays, as well as the Future 1 and 2 relays can be programmed to operate based on generic values. The Custom Output Menu will display each output, what it is programmed for and if there are any associated future inputs and/ or lights linked to the output. Please refer to Table 3 for the generic values the optional

outputs can be programmed for. Following is a description of the menu items in the Custom Outputs menu.

**Table 3. Generic Outputs**

Alarm
Low Pressure
High Pressure
Common Alarm
Low Fuel
Low Suction
Interlock On
Fail To Start
Engine Run
Engine Test Running
Weekly Test Timing
Call to Start
AC Power Failure Alarm
AC Power Failure Start
Low Room Temperature
Remote Start
Deluge Start
Manual Start
Low Pressure Start
Pump Start
RPT Timing
Sequential Start Timing
Charger #1 Failure
Charger #2 Failure
Battery #1 Failure
Battery #2 Failure
Off Mode
Manual Mode
Auto Mode
Pump Room Trouble
Engine Room Trouble
Controller Trouble
Sensor Failure
Backup Battery Low
Low Oil Pressure
High Engine Temperature
Overspeed Shutdown
ECM Sel. Switch in Alt.
Fuel Injection Malfunc.
Fuel Stop
Crank Battery #1
Crank Battery #2
Coil #1 Failure
Coil #2 Failure
Speed Switch Fault
Electronic Control Module Warning
Electronic Control Module Failure
High Raw Water Temperature

**Table 3. Generic Outputs (Continued)**

Alarm
Low Raw Water Flow
Low Engine Temperature

- **Latched Until Reset** - Output relays can be set as latching relays. Pressing the ACK/ALARM or RESET buttons will unlatch them. Default value is No.
- **Fail Safe** - Output relays can be programmed to energize under normal conditions (fail safe) or de-energize under normal conditions. Default value is No.
- **Timer** - Each output relay can be programmed as a time delay relay. Either as an On delay or as an Off delay. If it is set for On Delay (default) the relay will delay for the programmed time prior to activating the relay. If it is set for Off Delay the relay will activate instantly and then de-activate after the programmed time.

**Custom Lights** - The two (2) optional LED's can be programmed for alarms that do not have an associated LED or one of the custom inputs. In this section of the program, the LED's can be programmed for one of the values listed in Table 4. As a default the LED's will be programmed for Undefined.

**Table 4. Custom Lights**

Alarm
High Pressure
Common Alarm
Engine Test Running
Weekly Test Timing
Call To Start
AC Power Failure Alarm
AC Power Failure Start
Low Room Temperature
Manual Start
Low Pressure Start
Pump Start
RPT Timing
Sequential Start Timing
Off Mode
Manual Mode
Auto Mode
Pump Room Trouble
Engine Room Trouble
Controller Trouble
Sensor Failure
Backup Battery Low
Fuel Stop
Crank Battery #1
Crank Battery #2
Coil #1 Failure
Coil #2 Failure

## 6. HISTORY, DIAGNOSTICS, STATISTICS, CONFIGURATION

The Diesel Plus controller will record a number of items in its memory to assist with troubleshooting of the system and/or the fire pump controller.

These include system history, system statistics, diagnostics and system configuration.

### 6.1 System History

The Diesel Plus controller will record the last 10,000 alarm/status messages in its memory that can be viewed on the main display, saved to a USB storage device, or viewed on the optional embedded webpage.

In order to view the messages on the display press the up or down arrow buttons from the main screen until the display shows "Display Message History." Press the Ack. Alarm button to view the message history. The display will now show three messages at a time. Pressing the up or down arrow buttons will allow navigation showing the most recent message to the oldest message. Refer to Appendix L for common messages and their meaning.

Refer to Section 7 to save the message history to a USB storage device or to view the message history on the optional embedded webpage.

### 6.2 Statistics

The Diesel Plus controller will record a number of statistical points for a quick review of how the system has been operating. The statistics can be viewed on the main display, saved to a USB storage device, or viewed on the optional embedded webpage.

In order to view the statistics on the display press the up or down arrow buttons from the main screen until the display shows "Display Controller Statistics." Press the Ack. Alarm button to view the statistics. The display will show the statistics that the controller has recorded. Refer to Table 5 for the statistics included with the controller.

Refer to Section 7 to save the controller statistics to a USB storage device or to view the message history on the optional embedded webpage.

**Table 5. Controller Statistics**

Statistic	Range
Powered Time	000000.0-999999.9
Engine Run Time	00000.0-99999.9
Number of Calls to Start	00000-99999
Number of Starts	00000-99999
Last Engine Start	Date & Time
Last Engine Run Time	0000.0-9999.9
Last Low Pressure Start	Date & Time
Minimum Battery #1 Voltage	Unlimited
Minimum Battery #2 Voltage	Unlimited
Maximum Battery #1 Voltage	Unlimited
Maximum Battery #2 Voltage	Unlimited

**Table 5. Controller Statistics (Continued)**

Statistic	Range
Minimum Battery #1 Amperage	Unlimited
Minimum Battery #2 Amperage	Unlimited
Maximum Battery #1 Amperage	Unlimited
Maximum Battery #2 Amperage	Unlimited
Minimum System Pressure	Unlimited
Maximum System Pressure	Unlimited
Last System Startup	Date & Time
Last Engine Test	Date & Time
Last Low Oil Pressure	Date & Time
Last High Engine Temp.	Date & Time
Last Overspeed	Date & Time
Last Fail To Start	Date & Time
Last Low Fuel	Date & Time
Last Charger Failure	Date & Time
Last Battery Failure	Date & Time
Last ECM Alarm	Date & Time

### 6.3 Controller Diagnostics

The Diesel Plus controller has a number of diagnostic points that can be used to help in troubleshooting issues with the controller. The diagnostics can be viewed on the main display, saved to a USB storage device, or viewed on the optional embedded webpage.

In order to view the diagnostics on the display press the up or down arrow buttons from the main screen until the display shows "Controller Diagnostics." Press the Ack. Alarm button to view the diagnostics. The display will show the diagnostics. In order to navigate the diagnostics use the up or down arrow buttons.

#### NOTE

The diagnostic information shall be provided to personnel trained in the meaning of the values shown.

Diagnostic values that are recorded are the current date and time, the microprocessor's firmware version, Eaton's shop order number, customer order number, voltage readings, pressure sensor readings, input status, and relay status.

Refer to Section 7 to save the controller diagnostics to a USB storage device or to view the message history on the optional embedded webpage.

## 7. COMMUNICATION

The Diesel Plus controller is available with a number of optional communication protocols that can be used for the collection of information.

Communication protocols include USB (standard), Ethernet and RS485 (both optional).

### 7.1 USB

The USB port is used to download the controller message history, statistics, diagnostics, status and configuration data to a USB storage device. The USB port can also be used to upload custom messages, additional languages, and update the microprocessor firmware.

#### 7.1.1 Information Download

- In order to download the history, diagnostics, statistics, status and configuration - install a USB storage device into the USB port on the display board. With the power on, press the Data | Print button. The first selection is "Save to USB." Press the Ack. Alarm button and the controller will save the information to the USB storage device.
- There will be five (5) files saved to the storage device. Refer to Table 6 for the file nomenclature.

**Table 6. File Nomenclature**

File	Nomenclature	Description
ARC00000.csv	ARC=Archive 00000=Serial number	Message history
STC00000.txt	STC=Statistics 00000=Serial number	Controller statistics
DIA00000.txt	DIA=Diagnostics 00000=Serial number	Controller diagnostics
STA00000.txt	STA=Statistics 00000=Serial number	Controller status
CON00000.txt	CON=Configuration 00000=Serial number	Controller configuration

- The .csv file is a comma separated values file that can be opened using standard spreadsheet, word processor, or database programs. The .txt files can be opened using standard text viewers.

#### 7.1.2 Custom Message Upload

- The Diesel Plus controller has the ability to store and use up to ten (10) custom messages that can appear based on a specific date, time, alarm or status condition.
- Refer to Appendix H to upload and enable the custom messages.
- Refer to Section 8 for the creation of the custom message file.

#### 7.1.3 Firmware Update

- Contact the factory or an authorized trained representative for assistance.

#### 7.1.4 Language Upload

- Contact the factory or an authorized trained representative for assistance.

### 7.2 Embedded Webpage (Optional)

The controller is available with an optional webpage that can be used to view the main display of the controller and its current status.

Contact the factory or an authorized trained representative for assistance in accessing the webpage.



### 7.3 RS485 Serial Port (Optional)

Contact the factory or an authorized trained representative for assistance.

### 7.4 RS232 Serial Port (Optional)

This port is used with the optional printer (X1) to initiate a print cycle.

## 8. CUSTOM MESSAGES

In order to upload custom messages to the controller a file needs to be created. This section outlines the file format and trigger points required to use the custom messages.

All that is required to create the custom message file is a standard spreadsheet program. Specific software is not required.

Ten (10) custom messages can be saved in the file and uploaded to the controller for use. Each message will be entered in the first ten (10) rows of the spreadsheet. Do not use the top row as a heading row.

There are five (5) trigger points that can be used. They include specific date and time range, number of engine start events, number of hours run, specific alarms, or common alarm.

Figure 1 shows examples of the custom messages and how the file needs to be laid out. Following is a description of each column and the data required to be entered in the column.

	A	B	C	D	E
1	Message #1	1	MMDDYYHHMM	MMDDYYHHMM	
2	Message #2	2	XXXXX		
3	Message #3	3	XXXXX		
4	Message #4	4	XX		
5	Message #5	5			
6					
7					
8					
9					

Figure 1. Custom Message Examples

Column A contains the message that will scroll along the fourth line of the display. The message can be up to one hundred (100) characters in length.

Column B contains the message type reference number. Refer to Table 7 for the message types.

Table 7. Custom Message Types

Number	Description
1	Specific date and time range
2	Number of pump start events
3	Number of hours run
4	Specific alarms
5	Common Alarms

Column C and D are used to determine when the custom message will appear. Refer to the following for specific notes regarding each tripper point.

#### Date and Time Range (1)

Column C is used for the date and time that the message will start and column D is used for the date and time that the message will stop.

The date and time format is as follows:

MMDDYYHHMM = Month Day Year Hour Minute

If any value entered between 1 and 9 needs to be lead by a 0. For example, January 1, 2009, 8:15AM needs to be entered as 0101090815.

#### NOTE

All cells need to be formatted as text.

#### Number of Pump Start Events (2)

Column C is used to enter the number of pump starts before the message will appear.

The format is as follows:

XXXXX = Number of Pump Start Events

For example - to have the message appear after 25 pump start events it will be entered as 00025.

#### NOTE

All cells need to be formatted as text.

#### Number of Hours Run (3)

Column C is used to enter the number of hours the pump has run before the message will appear.

The format is as follows:

XXXXX = Number of Hours Run

For example, to have the message appear after 125 hours of running the trigger point will be entered as 00125.

#### NOTE

All cells need to be formatted as text.

**Specific Alarms (4)**

Column B is used to enter the alarm event number. Refer to Table 8 for the alarm events and their corresponding number.

**Table 8. Specific Alarm Events**

Number	Event	Number	Event
1	Battery #1/#2 Failure	16	Relief Valve Open
2	Charger #1/#2 Failure	17	Transmitter Failure
3	AC Failure	18	Pump Room Trouble
4	Low Oil Pressure	19	Controller Trouble
5	High Engine Temperature	20	Engine Trouble
6	Overspeed	21	Low Fuel
7	ECM in Alternate	22	Speed Switch Fault
8	Fuel Injection Malfunction	23	Coil #1/#2 Failure
9	Not in Auto	24	Electronic Control Module Warning
10	Fail to Start	25	Electronic Control Module Failure
11	Deluge Valve Off	26	High Raw Water Temperature
12	Low Foam Level	27	Low Raw Water Flow
13	Low Pressure	28	Low Engine Temperature
14	Low Room Temperature	29	Fuel Spill
15	Low Suction		

**Common Alarm (5)**

No other points are required to be entered into the spreadsheet, as this message will appear anytime there is an alarm.



### APPENDIX A: MAIN MENU TREE

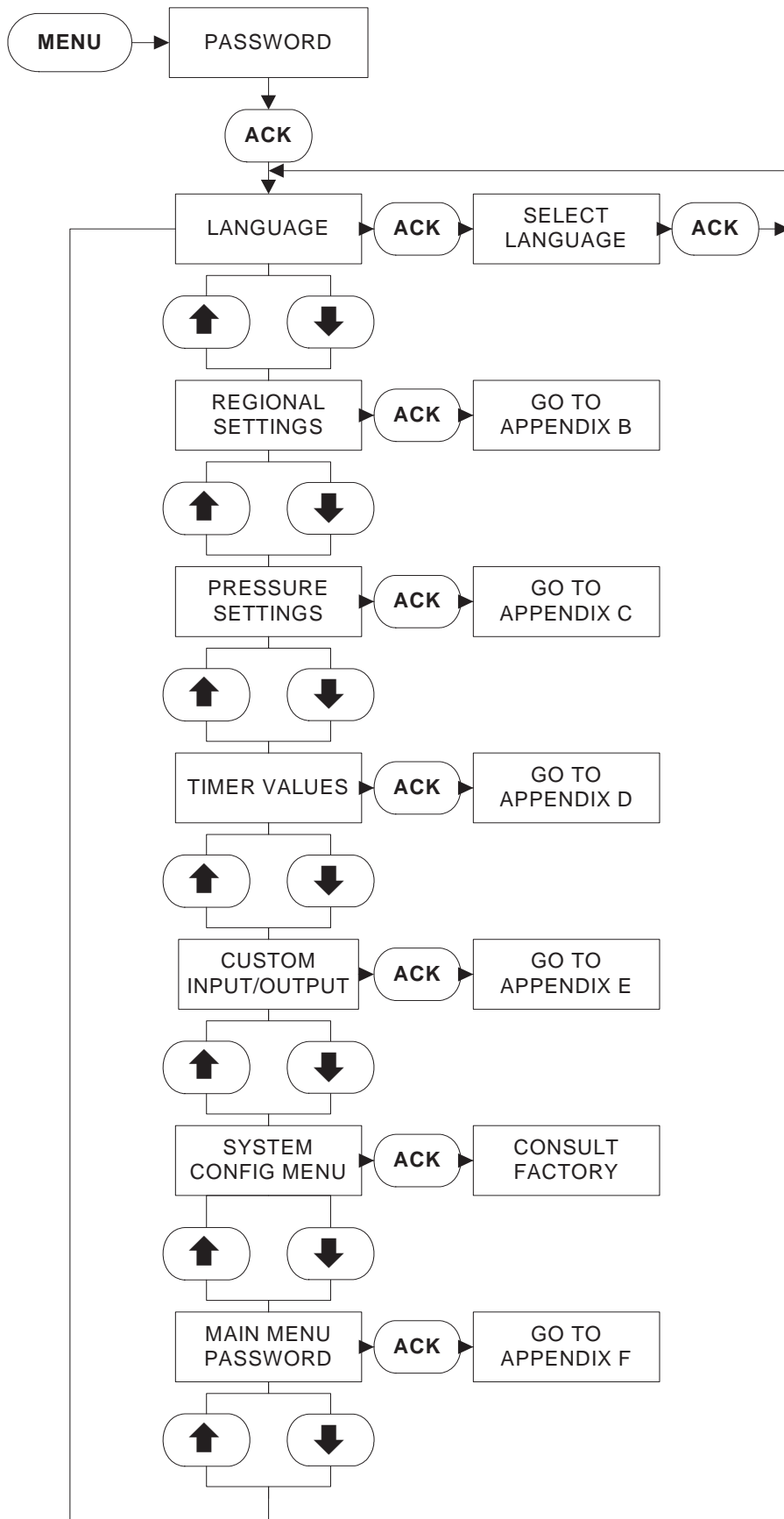

**APPENDIX B: REGIONAL SETTINGS MENU TREE**

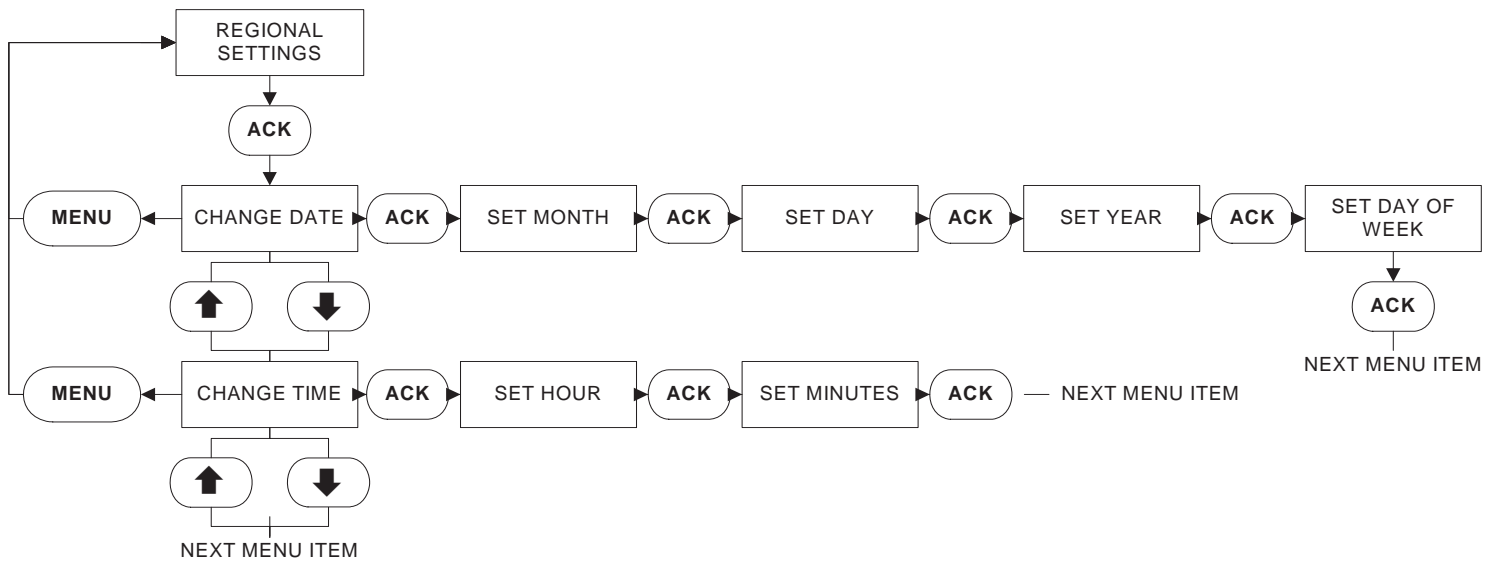

**APPENDIX C: PRESSURE SETTINGS MENU TREE**

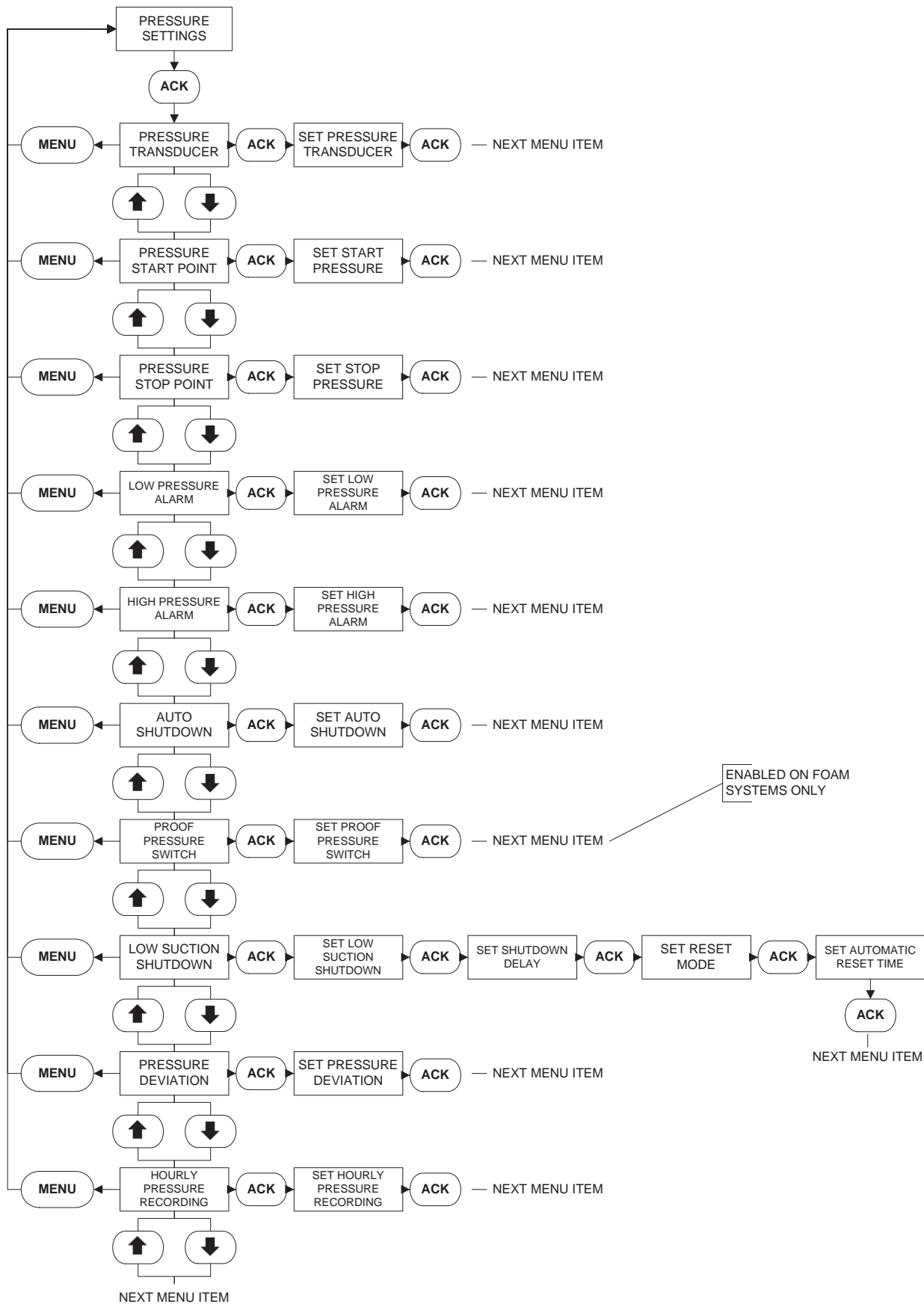

**APPENDIX D: TIMER VALUES MENU TREE**

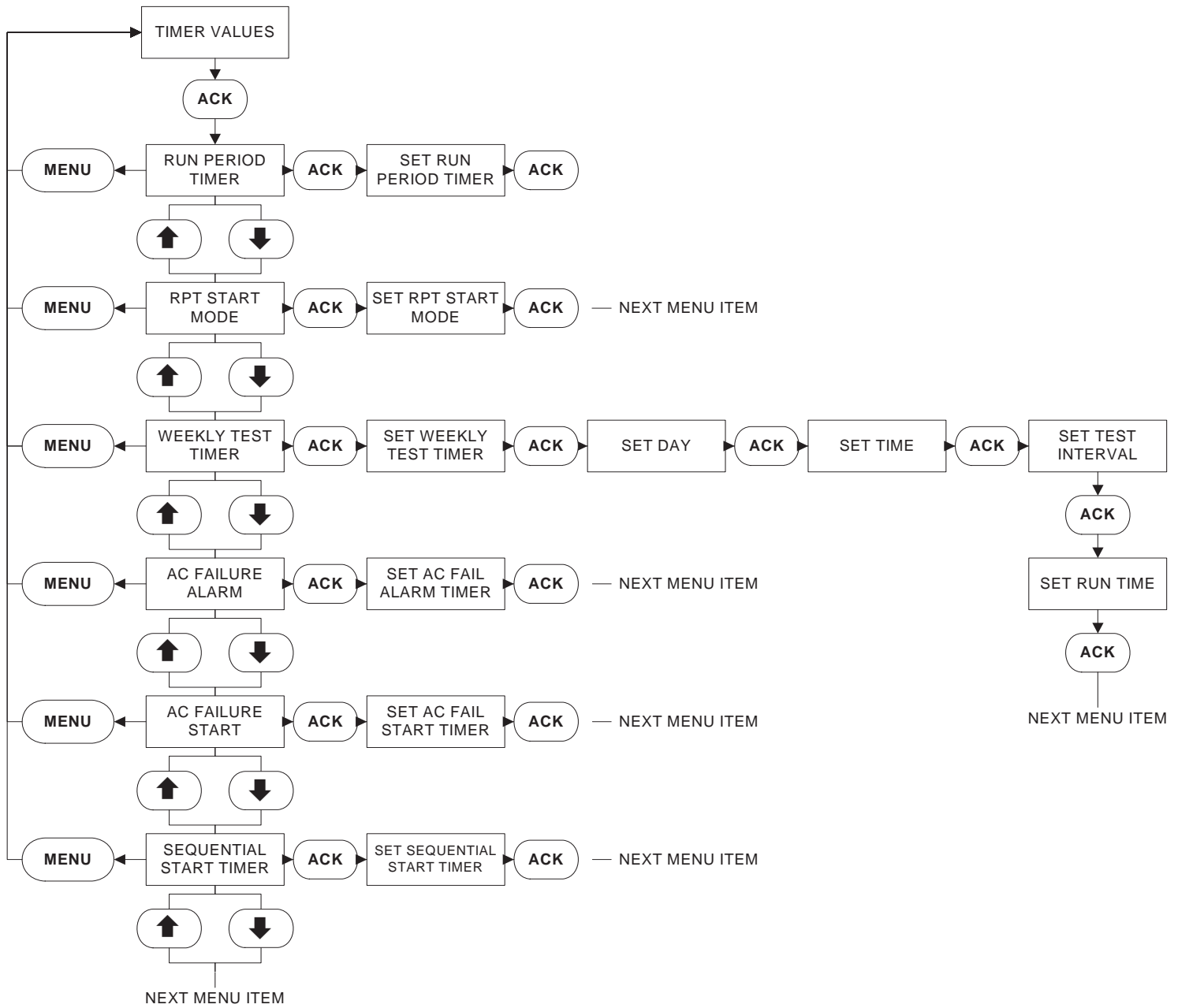

**APPENDIX E: CUSTOM INPUT/OUTPUT MENU TREE**

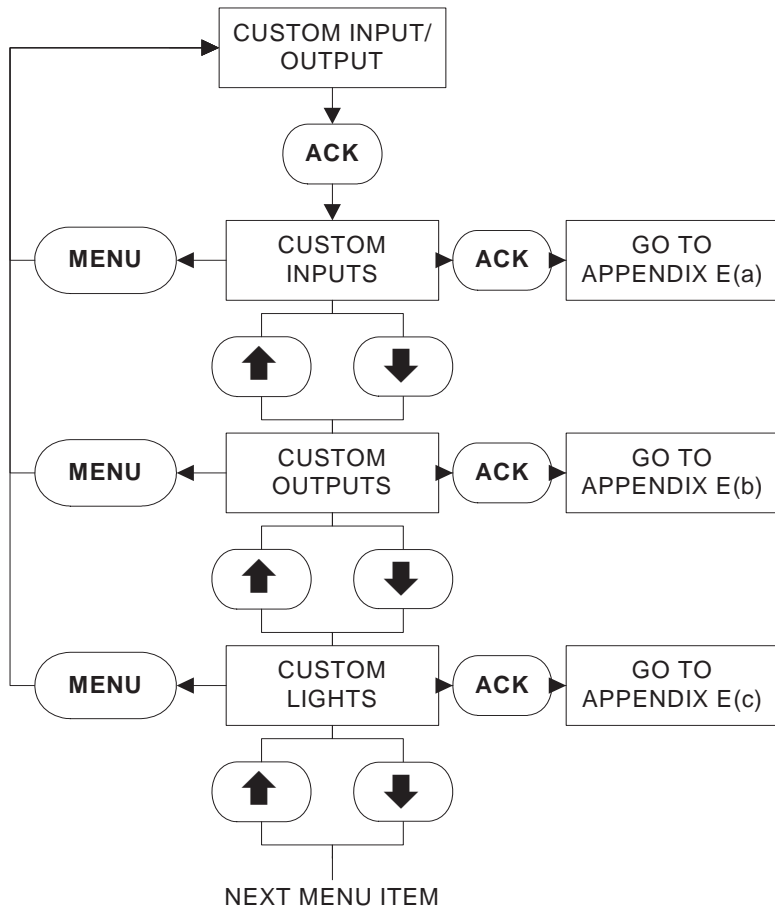

**APPENDIX E(a): CUSTOM INPUTS MENU TREE**

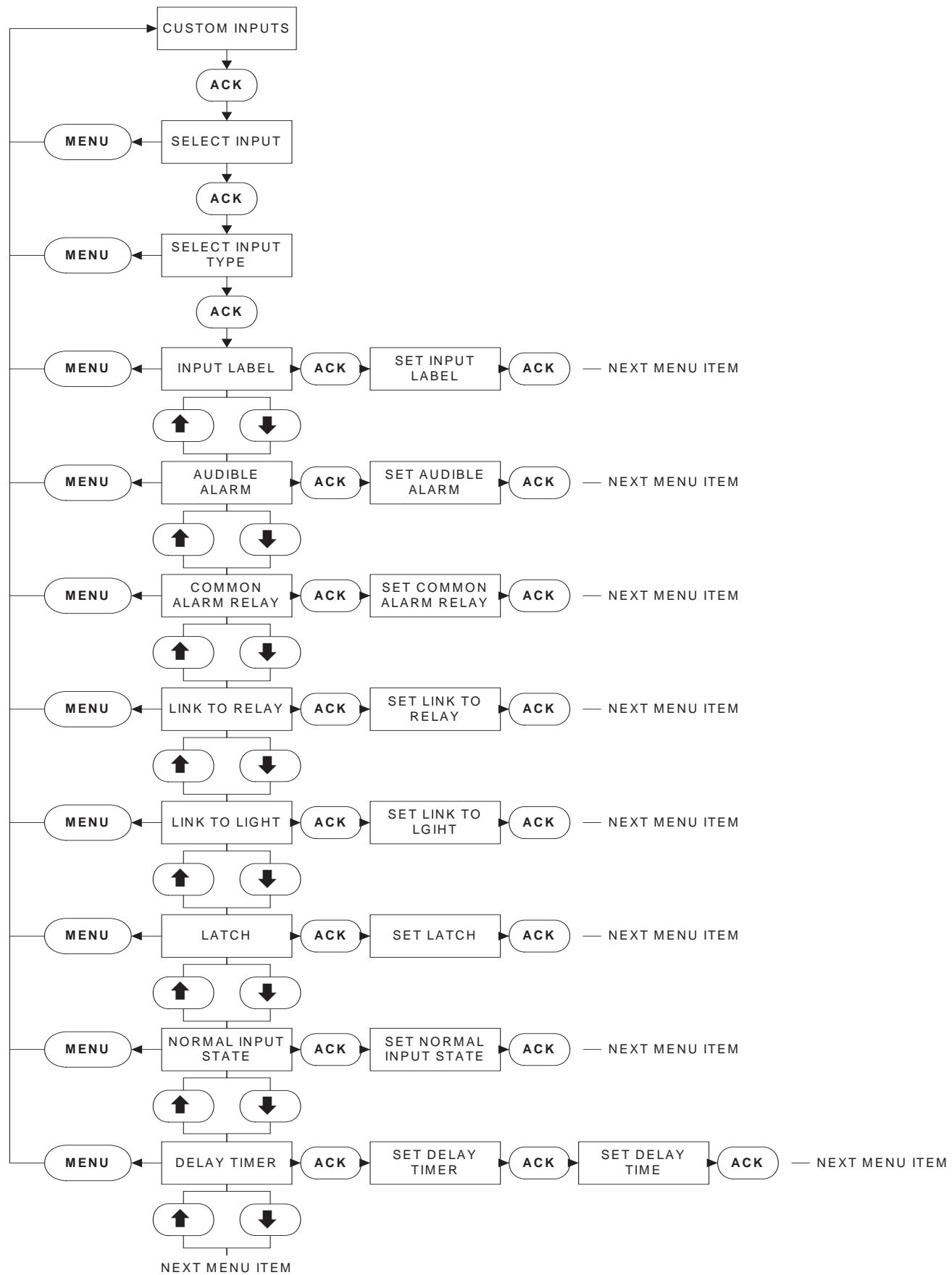

**APPENDIX E(b): CUSTOM OUTPUTS MENU TREE**

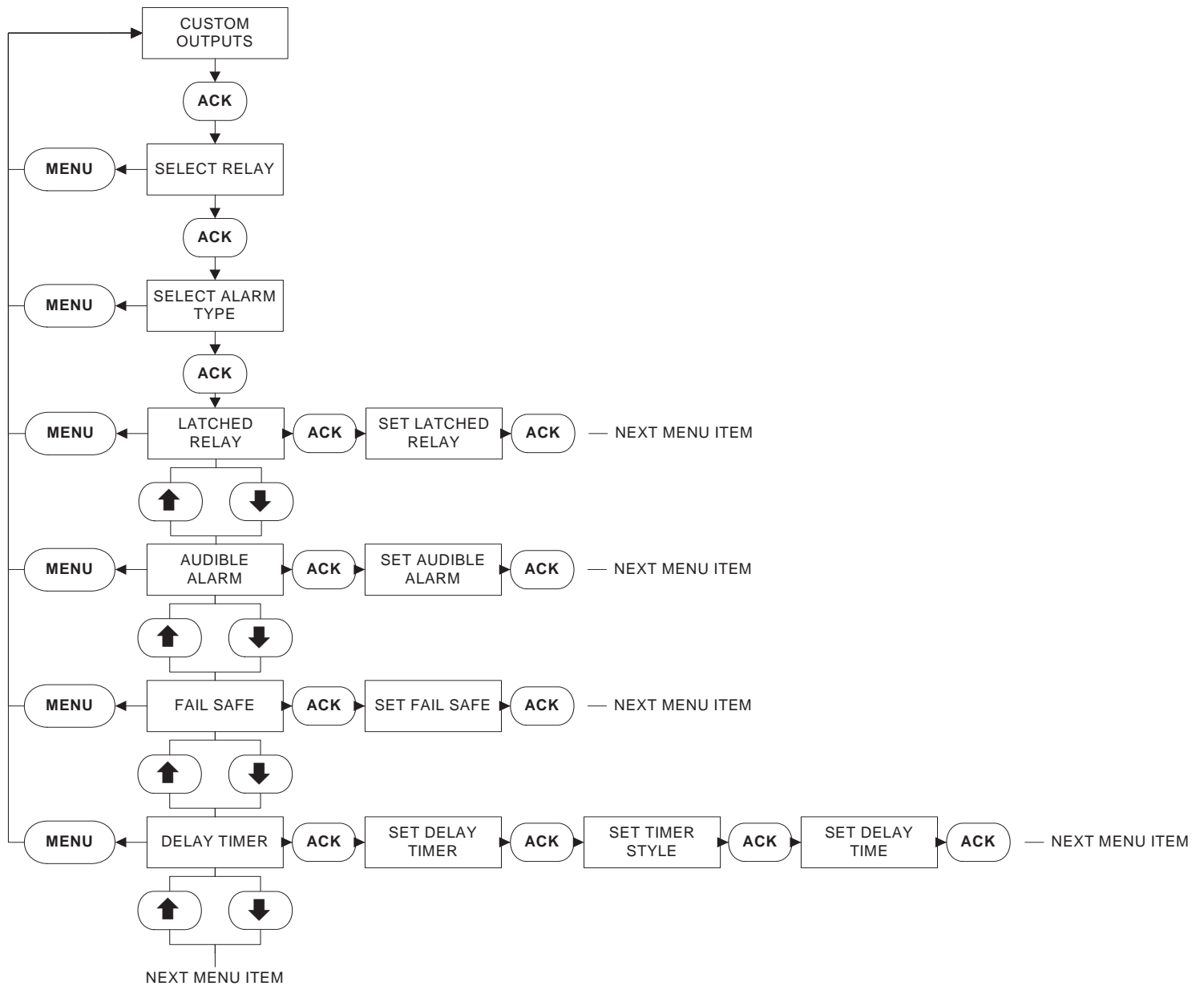



**APPENDIX E(c): CUSTOM LIGHTS MENU TREE**

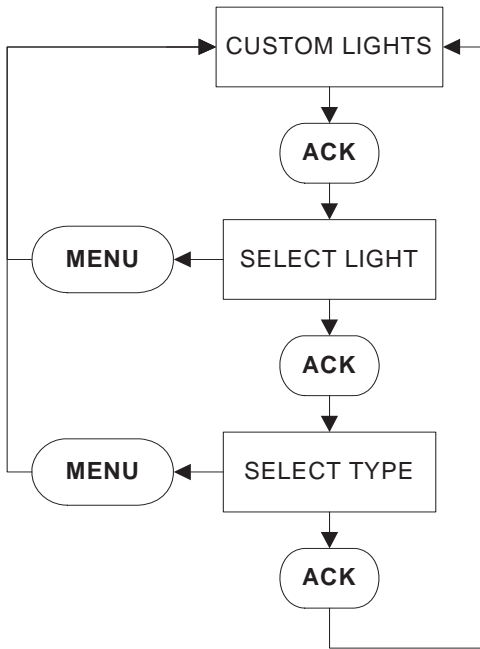

**APPENDIX F: MAIN MENU PASSWORD MENU TREE**

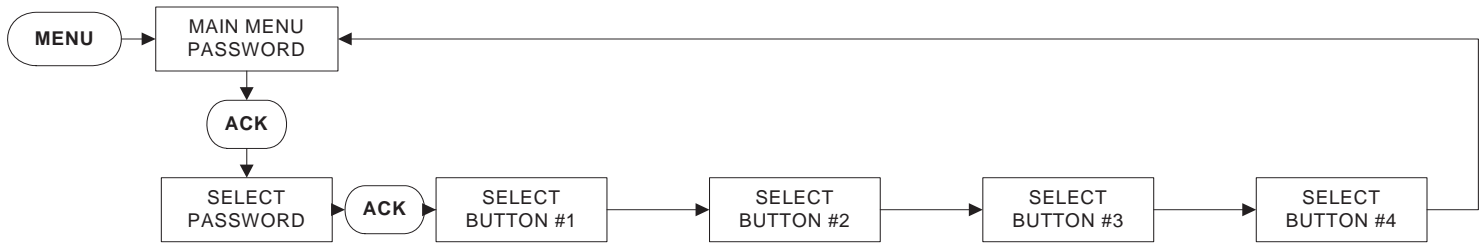

**APPENDIX G: CUSTOM MESSAGE LOAD & ACTIVATION**

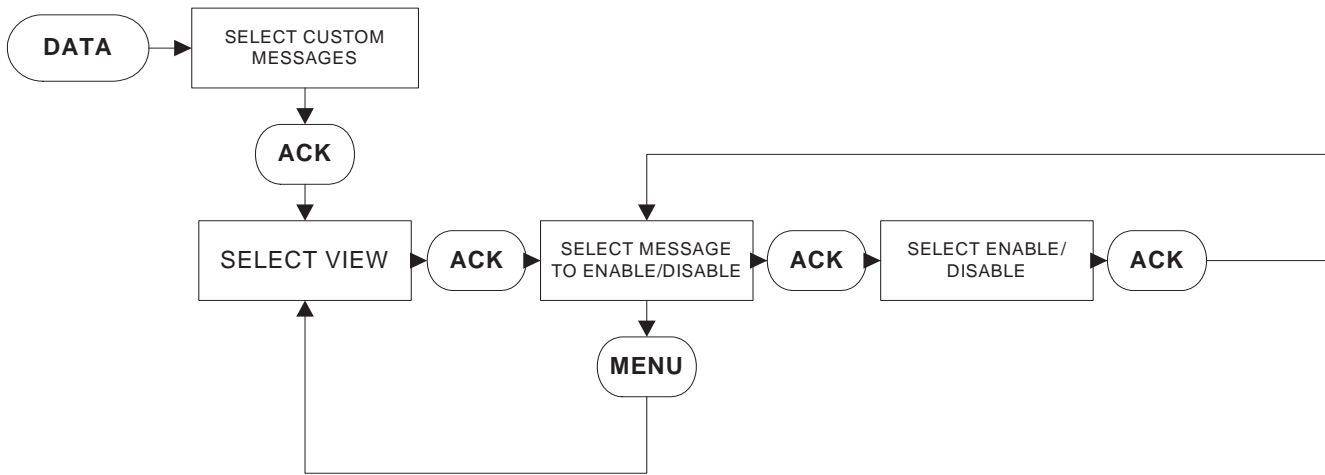
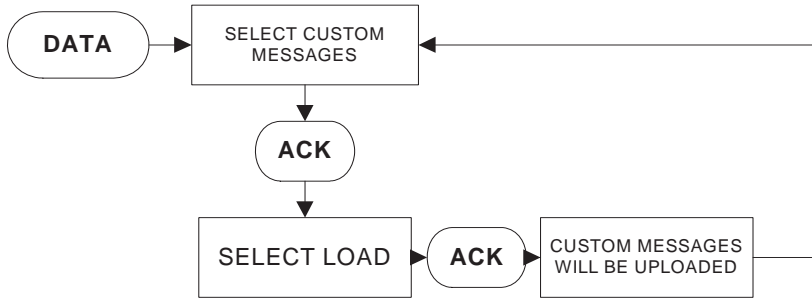

**APPENDIX K:**

- For control wiring, use #14 AWG wire for all electrical connections except battery connections.
- For battery connection, terminals 6, 7, 8 and 11, use the following:

**#10 AWG: 0' to 25' (7.62 m)**

**# 8 AWG: 25' to 50' (15.2 m)**

## APPENDIX L: ALARM/STATUS MESSAGES

Message	Description
AC Fail	Controller has detected AC Power Failure
AC Failure Start	The controller has started due to the loss of AC power. Starting delay is an adjustable menu item.
Auto Crank #1	The controller has initiated an automatic crank on starter #1
Auto Crank #2	The controller has initiated an automatic crank on starter #2
Auto Mode	The controller is in Automatic mode
Battery #1 Failure	The controller is receiving a signal that detects a weak or discharged battery
Battery #2 Failure	The controller is receiving a signal that detects a weak or discharged battery
Charger #1 Fail	The AC supply power to Charger #1 is lost or has malfunctioned.
Charger #2 Fail	The AC supply power to Charger #2 is lost or has malfunctioned.
Config. Data Changed	Changes have been made to the controller configuration. Modified menu items will be listed with new value.
Coil #1 Failure	Starter Coil #1 in the engine has failed or has been disconnected.
Coil #2 Failure	Starter Coil #2 in the engine has failed or has been disconnected.
Manual Crank #1	The Crank #1 pushbutton has been pressed
Manual Crank #2	The Crank #2 pushbutton has been pressed
Deluge Valve Start	The controller started the engine after it received a deluge valve start signal
Deluge Valve Off	The input to the deluge valve terminals has been removed
ECM in Alt Position	This is a signal sent to the controller to state the engine has switched to the alternate ECM module
Engine Overspeed	The controller has shutdown the engine due to an overspeed condition.
Electronic Control Module Failure	A signal is received from the engine indicating both the primary and alternate ECM have failed.
Electronic Control Module Warning	Indicates that the ECM has been switched from primary to alternate.
Engine Running	An engine run signal has been received from the engine.
Engine Stopped	The engine run signal is no longer being received
Engine Test Start	The engine has started on an engine test
Engine Test Fail	An Engine Test has been initiated, however an engine start has not occurred.
Fail to Start	An Engine start has been initiated, however the controller has failed to receive an engine run signal before the completion of the crank cycle.
Fuel Injection Malfunction	An alarm received by the engine signaling the controller that there is no fuel reaching the injectors
Fuel Stop	The Fuel Stop relay in the controller has been energized
High Engine Temperature	Indicates that the coolant temperature in the water jacket is extremely hot.
High Pressure	The system pressure is above the programmed high pressure alarm set point
High Raw Water Temperature	A signal is received from the engine indicating the water in the cooling loop has exceeded 105 degrees F.
High Temp Shutdown	Controller has shutdown due to a High Engine Temperature. (Engine/Weekly test only)
HR: Pres xxx PSI	Hourly Pressure recording value. Enabled in the menu.
Interlock Off	The interlock signal has been removed
Interlock On	The interlock signal has been received
Interlock Shutdown	The pump has been shutdown due to an interlock signal
Low Engine Temperature	A signal is received from the engine indicating the engine has been running for at least one hour and the coolant temperature reaches 90 degrees F.
Low Foam Level	The controller has received a low foam level signal
Low Fuel	A signal has been received from a remote contact indicating a Low Fuel condition.
Low Oil Pressure	The engine is showing low oil pressure
Low Pressure	The system pressure has dropped below the programmed pressure start point
Low Raw Water Flow	A signal is received from the engine indicating the raw water flow has dropped below 90% of the minimum flow rate.
Low Suction	The controller has received a low suction signal
Low Suction Shutdown	The controller has shutdown because of low suction
Manual Crank #1	The Controller was started via the Manual Crank button.
Manual Crank #2	The Controller was started via the Manual Crank button.

**APPENDIX L: ALARM/STATUS MESSAGES (Continued)**

Message	Description
Manual Mode	The controller is in Manual mode.
Manual Stop Request	The Stop pushbutton on the controller has been pressed
Menu Entered	The menu system was entered by a user
Off Mode	The controller is in Off mode
Pressure xxx PSI	System pressure readings the controller has recorded. Frequency adjusted via Pressure Deviation in the menu.
Pump Start	The pump has started via a pump start signal
Pump Start Off	The input to the Pump Start terminals has been removed
Remote Start	The pump has started via a remote start signal
RPT Timed Out	The running period timer has finished its timing cycle
RPT Stopped	The Run Period Timer has finished timing or been cleared.
Speed SW Malfunction	The engine run signal has been removed prior to the controller initiating a stop.
SST Started	The sequential start timer has started timing.
SST Stopped	The sequential start timer has finished timing or been cleared.
System Startup	Power has been reapplied to the system and a successful system boot has been completed
Transducer Fail	The controller has detected that the transducer has failed
Weekly Test Done	The weekly test has been completed
Weekly Test Fail	A Weekly test has been initiated, however the engine has failed to start.
Weekly Test Start	The engine has started on a weekly test
Weekly Test Stop	The Weekly Test Cycle timer has been cleared.

**9. INITIAL START UP**

Ensure that circuit breakers CB1 and CB2 are in the OFF (0) position.

Ensure that AC power is supplied to terminals L and N, and G is grounded.

Connect engine batteries to the controller, terminals 6, 8 and 11. If batteries are connected in wrong polarity the battery voltage will read zero.

Turn circuit breakers CB1 and CB2 ON ("1" position).

Pressure (start) is factory preset at 1 PSI.

Turn the mode selector switch to the "OFF" position

Ensure that the Diesel is programmed to user's specifications. Refer to section 5 in this manual.

**9.1 Automatic Start Test**

Turn the mode selector switch to the "AUTO" position.

Ensure that water pressure is available and the LCD display on the display panel is reading the system pressure correctly.

Decrease water pressure below the programmed start point. The controller will begin its cranking cycle.

Should the engine fail to start after 6 crank and rest cycles, the audible alarm will sound and the "Fail To Start" annunciator will illuminate. Turning the mode selector switch to the "OFF" position will silence the alarm.

When engine starts, "Engine Run" annunciator illuminates.

Increase water pressure above programmed START point. Press the stop pushbutton on the enclosure. If the pressure is satisfied, and there are no other starting conditions the engine will stop.

OR

If Auto Stop is programmed for "On", the engine will stop automatically after the Run Period Timer times out and pressure is satisfied. The RPT is programmed by the user; the factory setting is 30 minutes.

If the Sequential Timer is > 0 seconds, automatic start will be delayed by the number of seconds programmed.

**9.2 Manual Start Test**

Turn the mode selector switch to the "Manual" position

Press the Crank #1 pushbutton. The Engine will crank and start, the "Engine Run" annunciator will illuminate.

Press the STOP pushbutton. Wait for the engine to stop. Turn the mode selector switch to the "Manual" position.

Press the Crank #2 pushbutton. The Engine will crank and start, the "Engine Run" annunciator will illuminate.

Press the STOP pushbutton. The engine will stop. The engine will stop.

### 9.3 Engine Test

To run a manual test, depress the "Engine Test" button on the keypad. Then press ACK. The Drain Valve Solenoid will energize and drop the pressure on the controller to zero. The controller will start the engine automatically. The "Engine Run" annunciator will illuminate.

Press the STOP pushbutton.

The engine will stop.

---

#### NOTE

---

Engine will shutdown if Low Oil Pressure, High Water Temp or Overspeed alarms are detected during the engine test.

---

### 9.4 Weekly Exerciser Test

Turn the mode selector switch to the "OFF" position.

To test the Weekly Exerciser, preprogram the controller to initiate the test at a time suitable to the user.

Turn the mode selector switch to the "AUTO" position.

At the programmed time and date the drain valve solenoid will open. The Engine will crank and start. The "Engine Run" annunciator will illuminate and the drain valve solenoid will close.

Press the STOP pushbutton.

The engine will stop.

Reprogram Weekly Exerciser for normal operation.

This information booklet is published solely for information purposes and should not be considered all-inclusive. If further information is required, you should consult EATON.

Sale of product shown in this literature is subject to terms and conditions outlined in appropriate EATON selling policies or other contractual agreement between the parties. This literature is not intended to and does not enlarge or add to any such contract. The sole source governing the rights and remedies of any purchaser of this equipment is the contract between the purchaser and EATON.

NO WARRANTIES, EXPRESSED OR IMPLIED, INCLUDING WARRANTIES OF FITNESS FOR A PARTICULAR PURPOSE OR MERCHANTABILITY, OR WARRANTIES ARISING FROM COURSE OF DEALING OR USAGE OF TRADE, ARE MADE REGARDING THE INFORMATION, RECOMMENDATIONS AND DESCRIPTIONS CONTAINED HEREIN. In no event will EATON be responsible to the purchaser or user in contract, in tort (including negligence), strict liability or otherwise for any special, indirect, incidental or consequential damage or loss whatsoever, including but not limited to damage or loss of use of equipment, plant or power system, cost of capital, loss of power, additional expenses in the use of existing power facilities, or claims against the purchaser or user by its information, recommendations and description contained herein.