

Jockey Pump Controllers

JOCKEY
Touch™

Microprocessor Based with Color Touchscreen



Product Description

ACROSS THE LINE

JOCKEY PUMP CONTROLLERS

The JOCKEY Touch - Jockey Pump Controllers operate across-the-line. Full voltage is applied to the motor for starting by the use of a single motor starter. Starting inrush current is approximately 600% of rated full load amperes.

WYE-DELTA (Star-Delta)

JOCKEY PUMP CONTROLLERS

When six or twelve-lead delta connected jockey pump motors are started wye (star) connected, approximately 58% of line voltage is applied to each winding. The motor develops 33% of full-voltage starting torque and draws 33% of normal locked-rotor current from the line. After an adjustable time delay (during which the motor accelerates), it is reconnected for normal operation.

Product Features

Combination Motor Controllers

All JOCKEY Touch controllers are supplied with EATON combination motor controllers, which combine the circuit breaker and overload in one device.



Sealed Rotary Handle Mechanism

The rotary handle mechanism can be padlocked in the OFF position.

XT Power Controls

The JOCKEY Touch - Jockey Pump Controllers incorporate Eaton's XT Power Controls which are designed for the global marketplace. The XT controls carry global ratings, are small in size and are available in a wide variety of operating voltages. They are easy to install and maintain, due to their modular, plug-in design.

Universal Supply Voltage

The controllers will auto-detect three phase voltage supply from 200VAC to 600VAC, 50/60Hz and single phase from 110VAC to 240VAC, 50/60Hz, without the use of a control transformer.

NEMA 2 Enclosures

Enclosures have an oven baked powder paint finish and are supplied with NEMA 2 rating, unless otherwise ordered. Available options include: NEMA 3R, 4, 4X, 12.

Programmable Functions

Inputs, Outputs, Timers and Virtual LED's are programmable via the touchscreen display.

Starting Methods

There are four methods of starting the controller: Auto, Hand, Remote Start and Pump Start.

Diagnostics / Statistics

Eight diagnostics and seven statistics parameters can be monitored.

Alarm Setpoints

Four alarm setpoints can be programmed from the Alarm Setpoints sub-menu.

Color Touchscreen Display

The JOCKEY Touch - Jockey Pump Controllers are supplied with a microprocessor based, color touchscreen. The touchscreen display allows the user to monitor and program functions and values.

Pressure input is provided by a 4-20mA pressure sensor.



Technical Data

ACROSS-THE-LINE (Direct On Line)

JOCKEY PUMP CONTROLLERS

Line Voltage							
200-208V	220-240V	380-415V	440-480V	550-600V	120V-1Ph	240V-1Ph	
Motor Horsepower							
1/3-20Hp	1/3-20Hp	1/3-40Hp	1/3-50Hp	1/3-50Hp	1/3-2Hp	1/3-5Hp	

WYE-DELTA (Star-Delta)

JOCKEY PUMP CONTROLLERS

Line Voltage				
200-208V	220-240V	380-415V	440-480V	550-600V
Motor Horsepower				
1/3-40Hp (0.74-29.42Kw)	1/3-40Hp (0.74-29.42Kw)	1/3-50Hp (0.74-36.78Kw)	1/3-50Hp (0.74-36.78Kw)	1/3-50Hp (0.74-36.78Kw)

Standards & Certification

The JOCKEY Touch - Jockey Pump Controllers meet the requirements of the latest edition of NFPA 20 as well as meeting CE mark requirements. They meet or exceed the requirements of UL 508 [Underwriters Laboratories (UL)] and are approved by [Canadian Standards Association (CSA)].



Microprocessor - Color Touchscreen Display

Supply Voltage

3 phase – 200VAC to 600VAC, 50/60Hz
1 phase – 110VAC to 240VAC, 50/60Hz
True RMS measurement of 3 phase voltage inputs

Power Supply Output

Two 24VDC outputs
1 Power the pressure sensor
2 Energize the contactor coil

Ratings

NEMA 4 / 4X

Memory

Programmed settings saved in Non Volatile memory

Battery Backup

Real Time Clock kept intact during power failures

Ambient Temperature Rating

0C to 55C

Languages *

English
French
Spanish
Portuguese
Turkish

* Other languages available - consult factory for details

USB Port

Download Message History
Upload Firmware Updates

Programmable Inputs (2)

Each input can be programmed for one of seven different functions.

1 Interlock
2 Motor Overload
3 Fail to Start
4 Remote Start
5 Pump Start
6 Input = Output
7 Disabled

Programmable Outputs (2)

Each output can be programmed for one of twenty three different functions.

1 Power On	13 Undervoltage
2 Pump Run	14 Transducer Failure
3 Hand Mode	15 Motor Overload
4 Off Mode	16 Common Alarm
5 Auto Mode	17 Acceleration Timer
6 Low Pressure Alarm	18 Remote Start
7 High Pressure Alarm	19 Pump Start
8 Below Start Point	20 Interlock On
9 Phase Reversal	21 Input #1
10 Phase Failure	22 Input # 2
11 Fail to Start	23 Disabled
12 Undervoltage	

Timers (5)

Programmable Types

1 Minimum Run Timer
2 Sequential Start Timer
3 Pump Run Restart Timer
4 Acceleration Timer
5 Fail to Start Timer

Virtual LED's (2)

Programmable Functions (22)

1 Power On	12 Undervoltage
2 Pump Run	13 Overvoltage
3 Hand Mode	14 Transducer Failure
4 Off Mode	15 Motor Overload
5 Auto Mode	16 Common Alarm
6 Low Pressure Alarm	17 Remote Start
7 High Pressure Alarm	18 Pump Start
8 Below Start Point	19 Interlock On
9 Phase Reversal	20 Input #1
10 Phase Failure	21 Input # 2
11 Fail to Start	22 Disabled

Programmable Indication (5)

1 Red
2 Orange
3 Yellow
4 Green
5 Blue

Operation

Starting Methods (4)

1 Auto
2 Hand
3 Remote Start
4 Pump Start

Alarm Set Points (4)

1 Phase Reversal
2 Phase Failure
3 Over Voltage Alarm
4 Under Voltage Alarm

Message History (10K)

Messages time and date stamped

Diagnostics (8)

1 Firmware Version
2 Transducer Output
3 Transducer Current 1
4 Transducer Current 2
5 Input #1 Status
6 Input #2 Status
7 Relay #1 Status
8 Relay #2 Status
9 24VDC Output

Statistics (7)

1 Total Powered Time
2 Pump Run Total Time
3 Motor Starts
4 Minimum Voltage
5 Maximum Voltage
6 Minimum Pressure
7 Maximum Pressure



JOCKEY
 Touch™

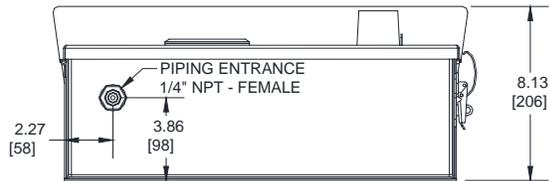
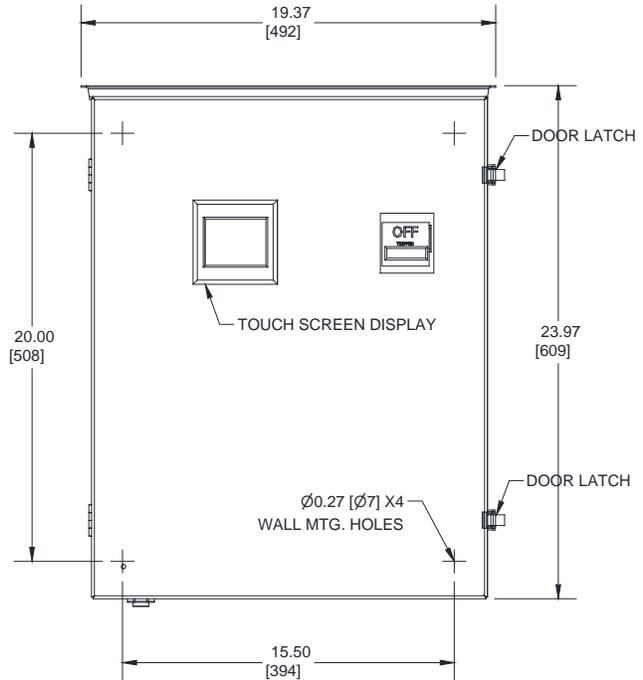
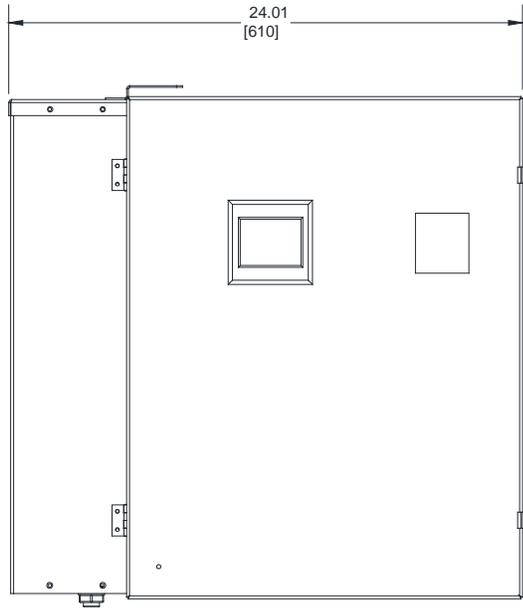

200-208V		220-240V		380-415V		440-480V		550-600V	
Motor Hp	Withstand Rating (kA)	Motor Hp	Withstand Rating (kA)	Motor Hp	Withstand Rating (kA)	Motor Hp	Withstand Rating (kA)	Motor Hp	Withstand Rating (kA)
15 - 40	100	15 - 40	100	20 - 50	100	25 - 50	100	40 - 50	25

Approx. Weight
 Lbs (Kg)
 55 (25)

NOTES:
 1. All enclosures finished in FirePump red.
 2. Cable Entrance either top or bottom.
 3. Standard Enclosure type NEMA 2

JOCKEY
 Touch™

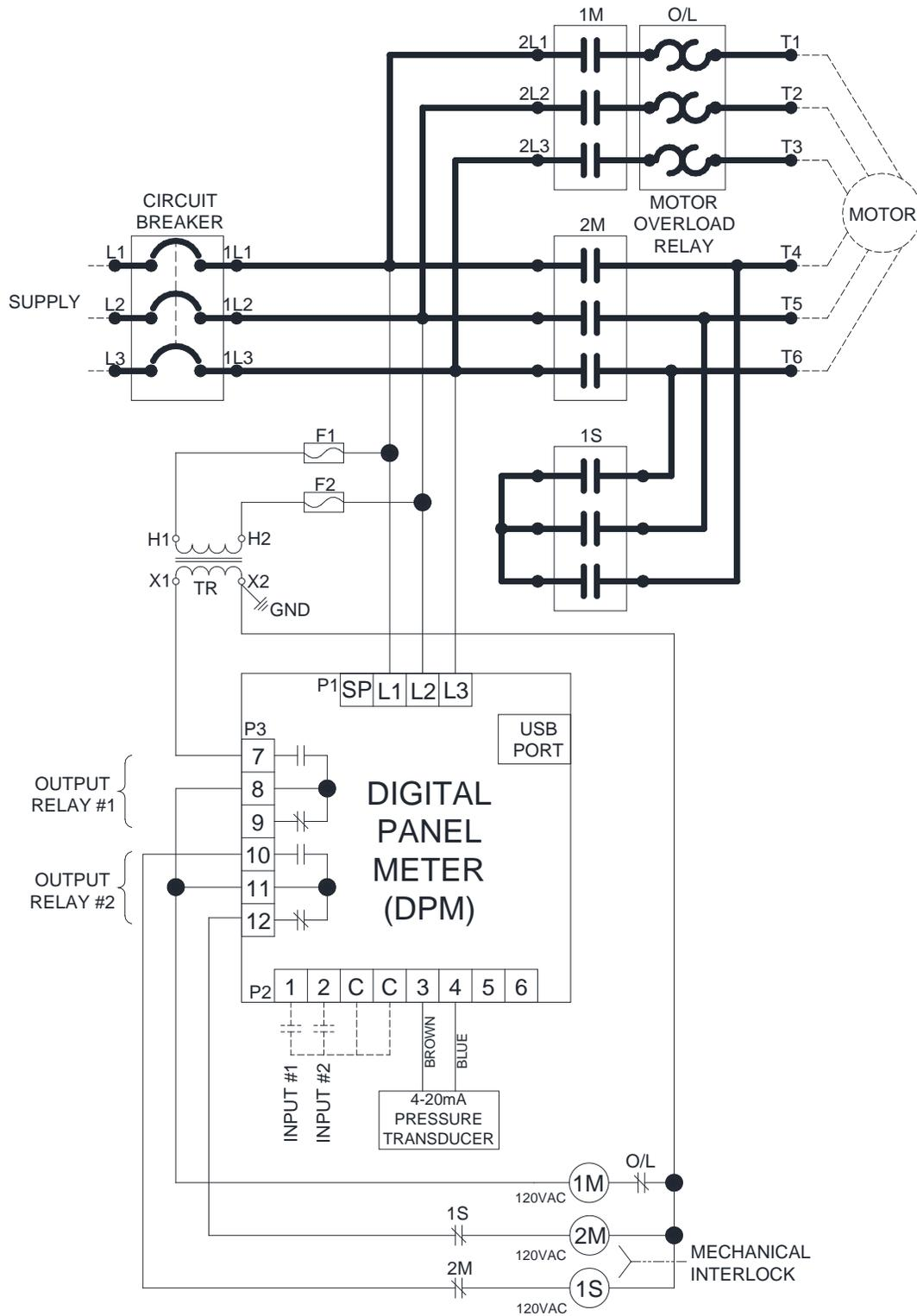



XTJP XTJY

NOTE: To select a proper part number - refer to the current Eaton Pricing Guidelines for available combinations.

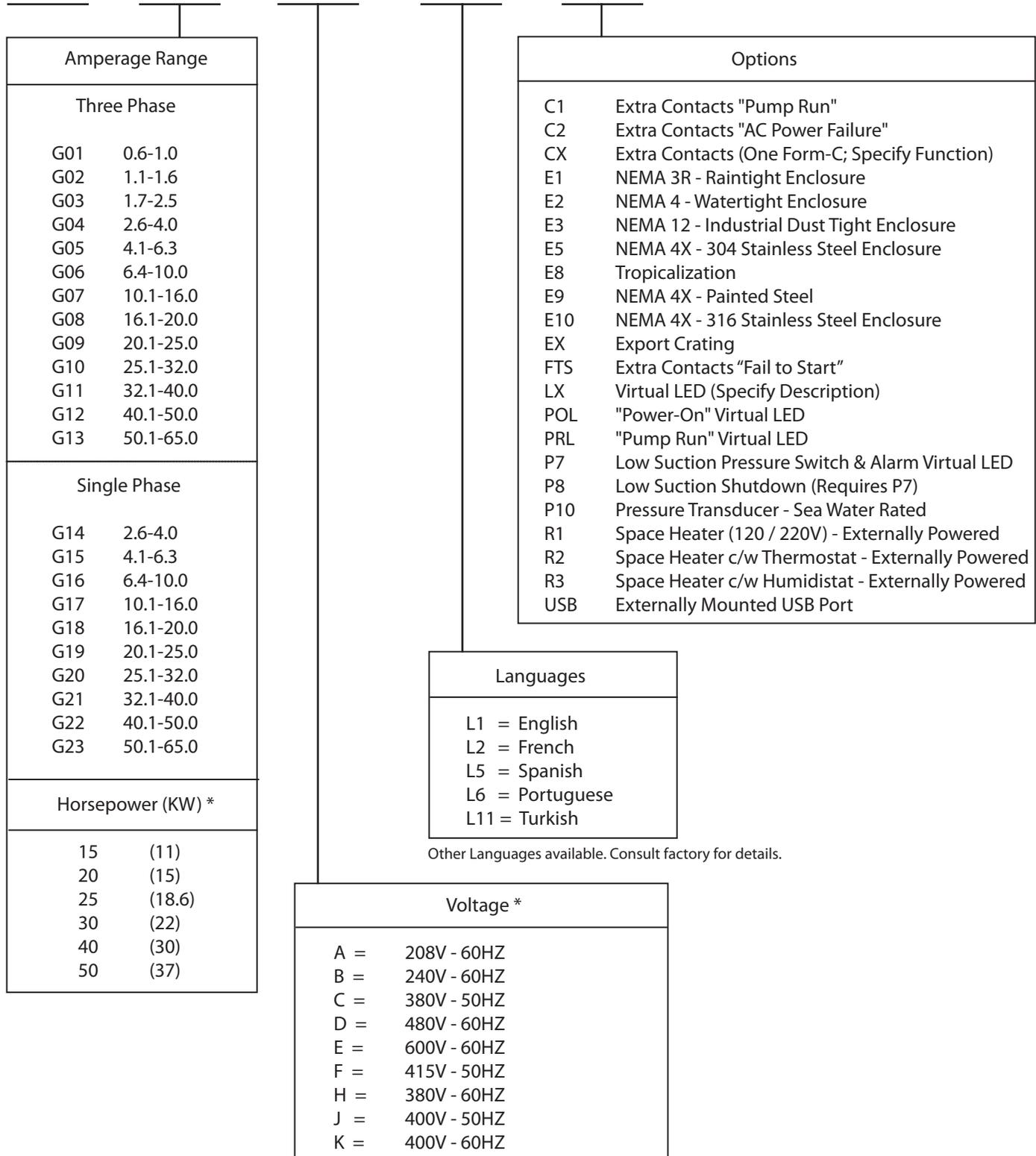

* NOTE: Voltage letter designations are only used when a Horsepower (KW) is selected.

XTJP / XTJY Jockey Pump Controllers

Typical Jockey Pump Controller Specifications

Approvals

The Jockey Pump Controller shall meet the requirements of the latest edition of NFPA 20 as well as meeting CE mark requirements. It shall meet or exceed the requirements of UL 508 [Underwriters Laboratories (UL)] standards and be approved by [Canadian Standards Association (CSA)].

Starting Type

The controller shall be Across-the-Line or Wye-Delta (Star Delta) type designed for full voltage starting.

Ratings

The Controller shall have a minimum withstand rating of 10,000 symmetrical amperes @ [208V] [240V] [380V] [400V] [415V] [480V] [600V] [120V Single Phase] [240V Single Phase].

The horsepower rating of the controller shall not exceed 50Hp for three (3) phase units or 10Hp on single phase units.

Construction

The controller shall include a combination Circuit Breaker / Overload Motor Protector.

The motor circuit protector shall be mechanically interlocked such that the enclosure door cannot be opened when the handle is in the on position except by a tool operated defeater mechanism.

The controller manufacturer shall manufacture the contactor, motor circuit protector, touchscreen display, and enclosure. Brand-labeled components will not be accepted.

Supply Voltage

The jockey pump controller shall auto-detect three phase voltage supply from 200VAC to 600VAC, 50/60Hz and single phase from 110VAC to 240VAC, 50/60Hz, without the use of a control transformer.

Coil Voltages

The jockey pump controller shall have the following available coil voltages
120VAC 50/60 Hz or 24VDC

Enclosure

The controller shall be housed in a NEMA Type 2 (IEC IP11) drip-proof, powder baked finish, freestanding enclosure.

Optional Enclosures

1. NEMA 3R (IEC IP14) rain-tight enclosure.
2. NEMA 4 (IEC IP66) watertight enclosure.
3. NEMA 4X (IEC IP66) watertight 304 stainless steel enclosure.
4. NEMA 4X (IEC IP66) watertight 316 stainless steel enclosure.
5. NEMA 4X (IEC IP66) watertight corrosion resistant enclosure.
6. NEMA 12 (IEC IP52) dust-tight enclosure.

Languages

The controller shall be available in a variety of languages including, but not limited to:
English, French, Spanish, Portuguese, Turkish.

Touchscreen Display

The controller shall be supplied with a color touchscreen display that shall indicate the following: Supply Voltage on all phases, Current Pressure, Start Pressure and Stop Pressure.

The touchscreen display shall be supplied with a solid-state 4-20mA pressure sensor. The pressure Start and Stop points shall be adjustable in increments of one (1) PSI or 0.1 BAR.

The touchscreen display shall be a door-mount type that permits exterior programming with the controller door secured.

Options

The jockey pump controller shall have provision to be supplied with the following options:

- C1 Extra Contacts " Pump Run"
- C2 Extra Contacts "AC Power Failure"
- CX Extra Contacts (One Form-C; Specify Function)
- E1 NEMA 3R – Raintight Enclosure
- E2 NEMA 4 – Watertight Enclosure
- E3 NEMA 12 – Industrial Dust Tight Enclosure
- E5 NEMA 4X – 304 Stainless Steel Enclosure
- E8 Tropicalization
- E9 NEMA 4X - Painted Steel
- E10 NEMA 4X - 316 Stainless Steel Enclosure
- EX Export Crating
- FTS Extra Contacts "Fail to Start"
- LX Virtual LED (Specify Description)
- POL "Power On" Virtual LED
- PRL "Pump Run" Virtual LED
- P7 Low Suction Pressure Switch and Alarm Virtual LED
- P8 Low Suction Shutdown (Requires P7)
- P10 Pressure Transducer – Sea Water
- R1 Space Heater (120 / 220V)
- R2 Space Heater c/w Thermostat
- R3 Space Heater c/w Humidistat

Manufacturer

The controller shall be of the XTJP Across-the-Line or XTJY Wye Delta (Star-Delta) type as manufactured by EATON.

EATON JOCKEY Touch™ Microprocessor Based Jockey Pump Controller



Contents

<i>Description</i>	<i>Page</i>	<i>Description</i>	<i>Page</i>
1. INTRODUCTION	3	APPENDIX A: MAIN MENU TREE	12
1.1 Safety	3	APPENDIX B(A): PANEL SETUP MENU TREE	13
1.2 Warranty	3	APPENDIX B(B): PANEL SETUP MENU TREE	14
1.3 Safety Precautions	3	APPENDIX B(C): PANEL SETUP MENU TREE	15
2. INSTALLATION AND ELECTRICAL CONNECTIONS	3	APPENDIX C(A): PRESSURE SETTINGS MENU TREE	16
2.1 Installation and Mounting of the Controller	3	APPENDIX C(B): PRESSURE SETTINGS MENU TREE	17
2.2 System Pressure Connection	3	APPENDIX C(C): PRESSURE SETTINGS MENU TREE	18
2.3 Electrical Connections	3	APPENDIX C(D): PRESSURE SETTINGS MENU TREE	19
2.4 Electrical Checkout Instructions	3	APPENDIX D: TIMER VALUES MENU TREE	20
2.4.1 Motor Rotation Check	3	APPENDIX E: ALARM SETPOINTS MENU TREE	21
2.4.2 Starting and Stopping	3	APPENDIX F(A): INPUTS / OUTPUTS / VIRTUAL LEDES MENU TREE	22
2.4.3 Motor Circuit Protector / Overload Relay Trip Setting	4	APPENDIX F(B): INPUTS / OUTPUTS / VIRTUAL LEDES MENU TREE	23
2.4.4 Circuit Breaker Trip Settings	4	APPENDIX F(C): INPUTS / OUTPUTS / VIRTUAL LEDES MENU TREE	24
3. HARDWARE DESCRIPTION	4	APPENDIX G: MESSAGE HISTORY / STATISTICS / DIAGNOSTICS MENU TREE	25
3.1 General	4	APPENDIX H: SAVE DATA TO USB MENU TREE	26
3.2 Contactor	4	APPENDIX J: UPDATE FIRMWARE MENU TREE	27
3.3 Front Operator Panel (Color Touchscreen Display)	4		
3.3.1 Memory	4		
3.3.2 Battery Backup	4		
3.3.3 Color Touchscreen Specifications	4		
3.3.4 Internal Power Supplies	4		
3.3.5 Supply Voltage	4		
3.3.6 Output Relays (2)	4		
4. OPERATION	4		
4.1 General	4		
4.2 Starting Methods	4		
4.2.1 Using the built in transducer in Auto mode with a programmable start point.	4		
4.2.2 Using the Hand mode push button on the touchscreen display	4		
4.2.3 Programming an input for Remote Start and closing the input	4		
4.2.4 Programming an input for Pump Start and closing the input.	4		
4.3 Programming	4		
4.3.1 Menu	4		
4.3.2 Hand / Off / Auto	5		
4.3.3 Pressure	5		
4.3.4 Voltage	5		
4.3.5 Timers	5		
4.3.6 Virtual LEDs	5		
4.3.7 Navigation	5		
4.3.8 Menu System	5		
4.3.9 Menu System Functions	6		

1. INTRODUCTION

1.1 Safety

This technical document is intended to cover most aspects associated with the installation, application, operation, and maintenance of the JOCKEY Touch™ Jockey Pump Controllers. It is provided as a guide for authorized and qualified personnel only in the selection and application of the JOCKEY Touch™ Controllers. If further information is required by the purchaser regarding particular installation, application, or maintenance activity, please contact an authorized EATON representative or the installing contractor.

1.2 Warranty

No warranties, expressed or implied, including warranties of fitness for a particular purpose of merchantability, or warranties arising from course of dealing or usage of trade, are made regarding the information, recommendations and descriptions contained herein. In no event will EATON be responsible to the purchaser or user in contract, in tort (including negligence), strict liability or otherwise for any special, indirect, incidental or consequential damage or loss whatsoever, including but not limited to damage or loss of use of equipment, plant or power system, cost of capital, loss of power, additional expenses in the use of existing power facilities, or claims against the purchaser or user by its customers resulting from the use of the information and descriptions contained herein.

1.3 Safety Precautions

All safety codes, safety standards, and/or regulations must be strictly observed in the installation, operation, and maintenance of this device. Starting types of the JOCKEY Touch™ Jockey Pump Controller include the following: XTJP-Across the Line, XTJP-Wye-Delta (Star-Delta).



COMPLETELY READ AND UNDERSTAND THE MATERIAL PRESENTED IN THIS DOCUMENT BEFORE ATTEMPTING INSTALLATION, OPERATION, OR APPLICATION OF THE EQUIPMENT. IN ADDITION, ONLY QUALIFIED PERSONS SHOULD BE PERMITTED TO PERFORM ANY WORK ASSOCIATED WITH THIS EQUIPMENT. ANY WIRING INSTRUCTIONS PRESENTED IN THIS DOCUMENT MUST BE FOLLOWED PRECISELY. FAILURE TO DO SO COULD CAUSE PERMANENT EQUIPMENT DAMAGE.

2. INSTALLATION AND ELECTRICAL CONNECTIONS

2.1 Installation and Mounting of the Controller

Carefully unpack the controller and inspect thoroughly. It is recommended that the controller is located as close as is practical to the motor it controls.

The controller is not free standing and must be bolted securely to a wall. For dimensional and weight data please refer to the respective data sheets for the Jockey Pump Controller.

2.2 System Pressure Connection

The Jockey Pump Controller is equipped with a Pressure Transducer. The controller is provided with a ¼" NPT female system pressure connection located on the bottom, external side of the enclosure.

NOTE: Water lines to the pressure transducer must be free from dirt and contamination. The pressure should not exceed what the pressure transducer is rated for.

2.3 Electrical Connections

All electrical connections should meet national and local electrical codes and standards.

The controller should be located or so protected that they will not be damaged by water escaping from pumps or pump connections.

Prior to starting, verify the AC line voltage on the nameplate matches the supply voltage onsite. Also verify the motor FLA matches the information on the nameplate.

Inspect all electrical connections, components and wiring for any visible damage and correct as necessary. Ensure that all electrical connections are tightened before energization.

Install necessary conduit using proper methods and tools.

Incoming AC line voltage is clearly marked L1, L2, L3 and ground, located at the top of the motor circuit protector.

2.4 Electrical Checkout Instructions



THE FOLLOWING PROCEDURES SHOULD BE CARRIED OUT BY A QUALIFIED ELECTRICIAN FAMILIAR WITH THE ELECTRICAL SAFETY PROCEDURES ASSOCIATED WITH THIS PRODUCT AND ITS ASSOCIATED EQUIPMENT.

2.4.1 Motor Rotation Check

With the controller energized, push the "HAND" button on the touchscreen display and then immediately push the "OFF" to check the direction of the motor and pump rotation. If rotation direction is not correct, open the motor circuit protector and reverse the phase sequence of the load terminals of the contactor T1, T2, T3 or at the motor terminals.

2.4.2 Starting and Stopping

Energize the controller. Push the "AUTO" button on the touchscreen display. If the system water pressure is lower than the pressure transducer set-point pressure the pump will start. The pump will stop when pressure is above the stop point. If the running period timer is programmed, the pump will run for the set time and then stop, provided the pressure is above the pressure stop point. For manual operation, push the "HAND" button on the touchscreen display to start the pump and the "OFF" button to stop.

2.4.3 Motor Circuit Protector / Overload Relay Trip Setting

The trip setting should be set to match the motor nameplate full load amps.

2.4.4 Circuit Breaker Trip Settings

When a Circuit Breaker is installed, the trip setting must be set as indicated on the chart on the inside of the controller.

3. HARDWARE DESCRIPTION

3.1 General

The purpose of this section is to familiarize the reader with the Jockey Pump Controller hardware, its nomenclature, and to list the unit's specifications.

3.2 Contactor

The contactor connects the pump motor to the supply, under control of the microprocessor.

The contactor coil is connected to the 24VDC source from the microprocessor.

Contactors in large horsepower controllers are supplied with 120VAC from a transformer.

3.3 Front Operator Panel (Color Touchscreen Display)

The front operator panel, depending on the installation, is normally accessible from the outside of the door. The front panel provides a means to:

- Alert the user to specific conditions.
- Program the controller.
- Set and monitor the operating parameters.

3.3.1 Memory

The XTJP has 10K of non-volatile memory which allows the recording and storage of up to 10,000 events.

3.3.2 Battery Backup

A ten (10) year, replaceable lithium battery allows a time clock to be kept during power failures. Removal of the battery does not affect programming.

3.3.3 Color Touchscreen Specifications

Aspect Ratio: 4:3

Resolution: 320X240 QVGA

Type: LCD display

Viewing Area: 3.5 inches diagonal

Rating: NEMA 4/4X

3.3.4 Internal Power Supplies

There are two (2) internal 24Vdc power supplies. One to power the transducer and one to provide power to energize the contactor coil.

3.3.5 Supply Voltage

3ph - 200V to 600Vac, 50/60Hz

1ph - 110V to 240Vac, 50/60Hz

3.3.6 Output Relays (2)

Each relay has one (1) set of Form-C contacts, rated 8A @ 250Vac.

4. OPERATION

4.1 General

When power is applied, the controller will delay starting in Hand or Auto mode for three (3) seconds to allow the controller mode to be changed before starting.

4.2 Starting Methods

There are four methods of starting the controller.

4.2.1 Using the built in transducer in Auto mode with a programmable start point.

4.2.2 Using the Hand mode push button on the touchscreen display.

4.2.3 Programming an input for Remote Start and closing the input

4.2.4 Programming an input for Pump Start and closing the input.

4.3 Programming

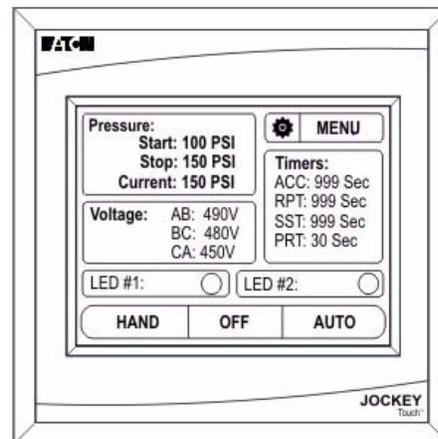

4.3.1 Menu

The Menu button initiates access to the menu system.

4.3.2 Hand / Off / Auto

The Hand/Off/Auto buttons on the display will put the controller into the selected mode. The mode selected will be indicated by means of a recessed, grey image. HOA modes are maintained after cycling of the AC power.

Upon exiting the Menu, the Hand / Off / Auto buttons are disabled for one second to prevent accidental placing of the controller in Auto mode.

4.3.3 Pressure

The Pressure display area will indicate the programmed Start Pressure, Stop Pressure and Current Pressure in 1 psi or 0.1 BAR increments.

If the stop pressure value is programmed higher than the start pressure value, the Main Menu Screen will indicate an error by displaying the start and stop pressure in RED.

4.3.4 Voltage

The Voltage display area / button will indicate the actual voltage across all three phases.

If the voltage display area / button is pressed, the display will indicate the programmed Overvoltage and Undervoltage percentages.

If the text in the voltage display area is Red, this indicates there is a phase failure, under voltage or over voltage condition.

4.3.5 Timers

The Timer display area will be visible only if a timer has been programmed and is currently timing. Up to four timers can be displayed at the same time in the timer display area.

4.3.6 Virtual LEDs

There are two (2) virtual LEDs on the Main Menu screen. Each one can be programmed for twenty two (22) separate status/alarms and inputs. Each virtual LED can be programmed to display in one of five (5) colors (Red, Orange, Yellow, Green, Blue).

4.3.7 Navigation

In order to enter the menu system, press the MENU button on the touchscreen display.

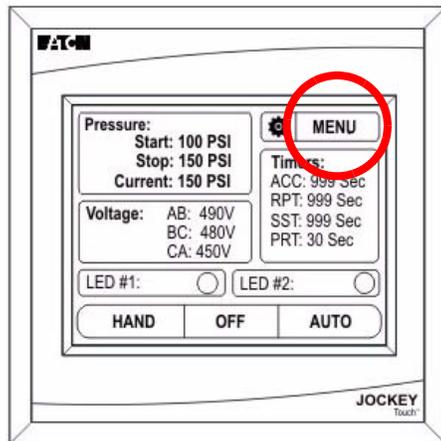

If the main menu password has been enabled, the user will be required to enter the password at this time.

Once in the menu system, the menu selections will be displayed. Up and Down arrow buttons on the display will provide navigation between each menu page.



The display will show up to five (5) menu selections per screen.

If the Back or Cancel buttons are held for two (2) seconds on any screen in the menu system, the display will return to the default screen.

If the OK button is held for two (2) seconds on any screen in the menu system, the values entered will be saved and the display will return to the default screen.

4.3.8 Menu System

The menu system is broken down to ten (10) menu selections. They include, Panel Setup, Pressure Settings, Timer Values, Alarm Setpoints, Inputs/Outputs/LEDs, Message History, Statistics, Diagnostics, Save Data to USB and Update Firmware.

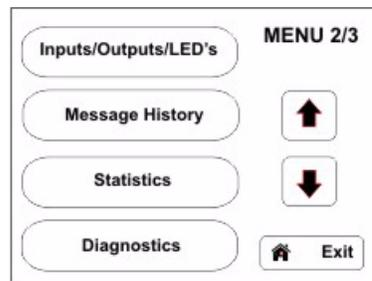
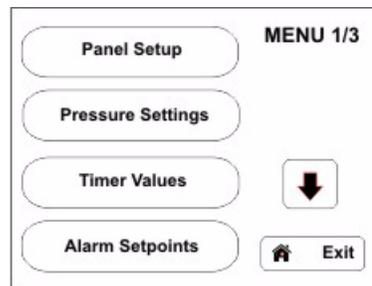

Detailed menu programming can be found in the Appendices section of this manual.

4.3.9 Menu System Functions

NOTE

THE CONTROLLER WILL EXIT ALL MENUS AND RETURN TO THE MAIN MENU SCREEN AFTER ONE (1) MINUTE OF NO ACTIVITY.

4.3.9.1 Panel Setup

The Panel Setup menu consists of two programming screens.

• PANEL SETUP 1/2

(Quick Setup, Language, Set Time, Set Date)

Quick Setup

The Quick Setup menu allows programming of the Time, Date, Start Pressure, Stop Pressure and Minimum Run Timer.

Language

The JOCKEY Touch™ is supplied with five (5) user selectable languages - English, French, Spanish, Portuguese and Turkish.

All programming menus will display in the selected language once the OK button has been used to enter the selection.

Other languages are available - contact Eaton for details.

Set Time

The time of day can be set using the Set Time function without entering into the Quick Setup menu.

Set Date

The date can be set using the Set Date function without entering into the Quick Setup menu.

• PANEL SETUP 2/2

(Nominal Voltage, Phases, Menu Password, Serial Number)

Nominal Voltage

The supply voltage to the controller is entered in the Nominal Voltage sub-menu.

Phases

Single or Three Phase operation is entered in the Phases sub-menu.

Menu Password

A four (4) digit numeric password can be programmed by the user.

The password function can be disabled by pressing the Disable button on the bottom right of the keypad.

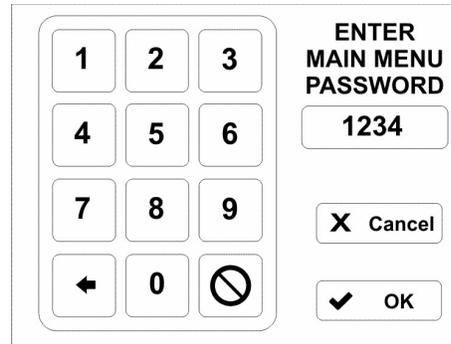

Once the password has been entered, a message will appear prompting the user to enter the password prior to entering the menu.

Serial Number

The controller is supplied with the serial number set by the factory. It can be modified during or after installation.

4.3.9.2 Pressure Settings

The Pressure Settings menu consists of two programming screens.

• PRESSURE SETTINGS 1/2

(Start Pressure, Stop Pressure, Low Pressure Alarm, High Pressure Alarm)

Start Pressure

The value programmed determines at which pressure the controller will initiate a start sequence.

Stop Pressure

The value programmed determines the pressure the system must reach before the controller will automatically stop the jockey pump motor. If the system pressure does not exceed the programmed Pressure Stop Point, the jockey pump motor will continue to run.

Low Pressure Alarm

A low pressure alarm point can be selected that will be recorded in the controller's history. The low pressure alarm can be programmed to activate one of the output relays and/or LEDs.

High Pressure Alarm

A high pressure alarm point can be selected that will be recorded in the controller's history. The high pressure alarm can be programmed to activate one of the output relays and/or LEDs.

• PRESSURE SETTINGS 2/2

(Pressure Deviation, Pressure Units, Calibrate Transducer)

Pressure Deviation

The Pressure Deviation (normally 10psi) is a three digit numeric entry. The controller will record a change in pressure in the message history based on the PD value programmed.

Eg: 10psi=recordseveryincreaseordecreaseof10psi.

Pressure Units

Pressure Units can be selected as PSI or BAR.

Calibrate Transducer

The pressure transducer can be calibrated using a partial or full calibration procedure.

Full Calibration requires the system to be reduced to a known value, typically 0 psi. This value is then entered into the controller. The system pressure is then increased to a higher known value which is also entered into the controller.

Calibrate Using Current Pressure is a partial calibration. The low pressure point is assumed to be correct. The high point is adjusted based on the actual system pressure.

Reset To Factory Default resets the transducer calibration to the original factory settings.

4.3.9.3 TIMER VALUES 1/2 (Minimum Run Timer, Sequential Start Timer, Pump Restart Timer, Acceleration Timer)

Minimum Run Timer

The run period timer is used to ensure the controller runs for minimum amount of time after an automatic starting condition.

While it is timing, the amount of time left on the timer will be displayed on the main display screen.

Sequential Start Timer

The SST can be set to delay the starting of the pump for all automatic starting conditions, such as when a low-pressure condition exists. If, during the timing of the sequential timer, the pressure rises above the pressure start point, the timer will stop timing and the starting sequence will discontinue. When the SST is timing, the time left will be displayed on the main display screen. The SST will not work on Remote starts, or if started in the Hand mode.

Pump Restart Timer

When the pump stops after it has already been running, the pump restart timer ensures that the pump remains shut down for a minimum of the time the PRT is programmed for, regardless of pressure.

Acceleration Timer

The acceleration timer can be programmed to allow the controller to run in a reduced voltage state for a period of time. This timer will start timing once a start signal has been received. An output relay must be programmed for the acceleration timer to use this feature.

4.3.9.4 TIMER VALUES 2/2 (Fail to Start Timer)

Fail To Start Timer

The Fail To Start timer is a factory set option.

An input contact and output relay are programmed for fail to start.

For indication, the Virtual LEDs can be programmed to indicate fail to start.

If the controller does not receive a contact closure from the contactor aux contact, within the programmed time, a fail to start message will be recorded in the message history and any relay / Virtual LED that is programmed will provide indication.

4.3.9.5 ALARM SETPOINTS (Phase Reversal, Phase Failure, Overvoltage Alarm, Undervoltage Alarm)

Phase Reversal

The Phase Reversal button allows the selection of rotation as ABC or CBA.

Phase Failure

Phase Failure is user programmable as a percentage value of the Nominal Voltage.

Overvoltage Alarm

Overvoltage is user programmable as a percentage value of the Nominal Voltage.

Undervoltage Alarm

Undervoltage is user programmable as a percentage value of the Nominal Voltage.

4.3.9.6 Inputs / Outputs / LEDS

• Programmable Inputs

There are two (2) programmable "voltage free" inputs. Each input can be programmed for one of seven (7) functions.

Programmable Inputs	
Functions (7)	
1	Interlock
2	Motor Overload
3	Fail to Start
4	Remote Start
5	Pump Start
6	Input = Output
7	Disabled

Interlock

A contact closure will prevent the controller from starting, and shut the controller down when running unless the controller was started via the "Hand" button on the main display screen.

Motor Overload

When an input is programmed for Motor Overload, a contact closure indicates the controller is in an overload condition. This feature will be used for linking to outputs/virtual LED's and be recorded in the message history.

Fail to Start

When an input is programmed for Fail to Start, a contact closure indicates the contactor has successfully closed. If this does not happen before the Fail to Start Timer has expired, it indicates a Fail to Start condition. This feature will be used for linking to outputs/virtual LEDs and be recorded in the message history.

Remote Start

While the controller is in Auto mode, the controller will start when the input is momentarily or continually closed. To stop the controller, the unit must be placed in Off Mode or receive an interlock signal. Remote start will ignore the Sequential Start Timer (SST), Minimum Run Timer (RPT), and Pump Restart Timer.

Pump Start

While the controller is in Auto mode, the controller will start when the input is closed, and the SST has timed out (if the SST has been enabled). The controller will shut down when the input is opened, after the RPT times out. A valid interlock input or placing the controller in Off Mode will shut the controller down. The controller will not start until after the Pump Restart Timer has been satisfied.

Input = Output

The controller will record when the input is closed. This setting is used when linking output relays and Virtual LED's to the input.

Disabled

Changing of the input state will be shown in the diagnostic screen but have no other effect on the controller.

- **Programmable Outputs**

There are two (2) Form-C programmable output relays. Each output can be programmed for one of twenty three (23) functions. All output relays are disabled in OFF mode.

Programmable Outputs (2)			
Each output can be programmed for one of twenty three different functions			
1	Power On	13	Overvoltage
2	Pump Run	14	Transducer Failure
3	Hand Mode	15	Motor Overload
4	Off Mode	16	Common Alarm
5	Auto Mode	17	Acceleration Timer
6	Low Pressure Alarm	18	Remote Start
7	High Pressure Alarm	19	Pump Start
8	Below Start Point	20	Interlock On
9	Phase Reversal	21	Input #1
10	Phase Failure	22	Input #2
11	Fail to Start	23	Disabled
12	Undervoltage		

Power On

When programmed for Power On, the output relay will be energized whenever there is power applied to the controller.

Pump Run

When programmed for Pump Run, the output relay will be energized whenever the 24VDC output is energized.

Hand Mode

When programmed for Hand mode, the output relay will be energized when the Hand/Off/Auto button is in the Hand position.

Off Mode

When programmed for Off Mode, the output relay will be energized when the Hand/Off/Auto button is in the Off position.

Auto Mode

When programmed for Auto Mode, the output relay will be energized when the Hand/Off/Auto selector switch is in the auto position.

Low Pressure Alarm

When programmed for Low Pressure Alarm, the output relay will be energized when the system pressure is below the low pressure alarm set-point.

High Pressure Alarm

When programmed for High Pressure Alarm, the output relay will be energized when the system pressure is above the high pressure alarm set-point.

Below Start Point

When programmed for Below Start Point, the output relay will be energized when the system pressure is below the low pressure start point.

Phase Reversal

When programmed for Phase Reversal, the output relay will be energized when a phase reversal condition exists.

Phase Failure

When programmed for Phase Failure, the output relay will be energized when a phase failure condition exists.

Fail to Start

When programmed for Fail to Start, the output relay will be energized when an input is programmed for fail to start, and the input has not closed by the time the fail to start timer has timed out. The condition will reset if the contactor closes, or the controller is placed in off mode.

Undervoltage

When programmed for Undervoltage, the output relay will be energized when an undervoltage condition exists.

Overvoltage

When programmed for Overvoltage, the output relay will be energized when an overvoltage condition exists

Transducer Failure

When programmed for Transducer Failure, the output relay will be energized when the transducer output is below 3.9mA or above 20.1mA.

Motor Overload

When programmed for Motor Overload, the output relay will be energized when an input is programmed for Motor Overload and the contact is closed.

Common Alarm

When programmed for Common Alarm, the output relay will be energized when the panel is in off mode, or when high pressure alarm, phase reversal, phase failure, fail to start, undervoltage, overvoltage, transducer failure, or motor overload conditions are present.

Acceleration Timer

When programmed for Acceleration Timer, the output relay will energize when any starting condition exists, after the acceleration timer has timed out. The relay will de-energize when the pump is no longer running.

Remote Start

When programmed for Remote Start, the output relay will be energized when an input is programmed for remote start, the input was closed, and the pump is running

Pump Start

When programmed for Pump Start, the output relay will be energized when an input is programmed for pump start, the input is closed, and the pump is running.

Interlock On

When programmed for Interlock On, the output relay will be energized when an input is programmed for Interlock, and the input is closed.

Input #1

When programmed for Input #1, the output relay will energize when Input #1 is closed.

Input #2

When programmed for Input #2, the output relay will energize when Input #2 is closed.

Disabled

When programmed for Disabled, the output relay is disabled and does not change state for any reason.

4.3.9.7 VIRTUAL LEDES

There are two (2) virtual LEDs on the Main Menu screen. Each one can be programmed for twenty two (22) separate status/alarms and inputs. Each virtual LED can be programmed to display in one of five (5) colors (Red, Orange, Yellow, Green, Blue).

• LED #1

LED #1 display area will be visible only if LED #1 has been programmed. The LED description will be displayed in the left hand portion of the display area. The LED button will indicate the function that it has been programmed for. The LED light will indicate in the user selected color.

• LED #2

LED #2 display area will be visible only if LED #2 has been programmed. The LED description will be displayed in the left hand portion of the display area. The LED button will indicate the function that it has been programmed for. The LED light will indicate in the user selected color.

Virtual LED's			
Functions (7)			
1	Power On	12	Overvoltage
2	Pump Run	13	Transducer Failure
3	Hand Mode	14	Motor Overload
4	Off Mode	15	Common Alarm
5	Auto Mode	16	Acceleration Timer
6	Low Pressure Alarm	17	Remote Start
7	High Pressure Alarm	18	Pump Start
8	Below Start Point	19	Interlock On
9	Phase Reversal	20	Input #1
10	Phase Failure	21	Input #2
11	Fail to Start	22	Disabled
Programmable Indication (5)			
1	Red		
2	Orange		
3	Yellow		
4	Green		
5	Blue		

4.3.9.8 Message History

Up to ten (10) events can be viewed on the Message History screen. Event dates and times are also displayed.

Pressing the Up or Down arrow buttons will advance through messages saved in the memory one at a time.

Pressing the Page up or Page down arrow buttons will advance through messages saved in the memory 10 messages at a time.

Pressing and holding the Up, Down, Page Up or Page Down arrows, allows the messages to scroll continuously through all messages saved in the memory. (The scrolling speed increases the longer the button is held for.)

Message History data is stored in a comma separated value (CSV) format.

The Message History screen displays an indication of the current record highlighted of the total number of stored records.
Eg: 25 of 2503.

4.3.9.9 Statistics

Seven (7) controller statistics can be viewed on the Controller Statistics screen.

Statistics	
1	Total Powered Time
2	Pump Run Total Time
3	Motor Starts
4	Minimum Voltage
5	Maximum Voltage
6	Minimum Pressure
7	Maximum Pressure

Values can be cleared by pressing the 'Clear All Statistics' button. Statistics data will be stored in a text (.txt) format.

4.3.9.10 Diagnostics

The Firmware Version as well as the status of the transducer, inputs and relay outputs are displayed on the Controller Diagnostics screen. Diagnostics data will be stored in a text (.txt) format.

Diagnostics (8)	
1	Firmware Version
2	Transducer Output
3	Transducer Current 1
4	Transducer Current 2
5	Input #1 Status
6	Input #2 Status
7	Relay #1 Status
8	Relay #2 Status
9	24VDC Output

Save Data to USB Drive

Data can be saved to an external USB memory device via the USB port, located on the back of the touchscreen display unit. Select the 'Save Data to USB' button from Menu 3/3 screen and follow the prompts.

Statistics, Diagnostics, Configuration and Message History will be saved to the USB device.

Update Firmware

Firmware can be uploaded from an external USB memory device via the USB port, located on the back of the touchscreen display unit. Select the 'Update Firmware' button from the Main Menu 3/3 screen and follow the prompts.

Table 1. Programmable Features and Set Points

Description	Default	Range
Panel Setup		
Language	English	English, French, Spanish, Portuguese, and Turkish
Change Time	12:00	24 Hours
Change Date	1/1/2014	Any valid date
Nominal Voltage	480V	110V-600V
Phases	Three Phase	Single Phase, Three Phase
Menu Password	Disabled	Four digit numeric password or Disabled
Serial Number	16C0000J	A fixed 16 prefix with space for (7) seven additional digits. Eg. "16C1234J1."
Pressure Settings		
Start Pressure	0 PSI	0-999 PSI
Stop Pressure	0 PSI	0-999 PSI
Low Pressure Alarm	0 PSI	0-999 PSI
High Pressure Alarm	999 PSI	0-999 PSI
Pressure Deviation	15 PSI	0-999 PSI
Pressure Units	PSI	PSI or BAR
Calibrate Pressure Transducer	Based on a 0-500 PSI Transducer	Calibrate Using 0 PSI / Calibrate Using Current Pressure
Timer Values		
Minimum Run Time	Disabled	0-999 Seconds
Sequential Start Timer	Disabled	0-999 Seconds
Pump Restart Timer	Disabled	0-999 Seconds
Acceleration Timer	Disabled	0-999 Seconds
Fail To Start	Disabled	0-999 Seconds
Alarm Set Points		
Phase Reversal	Disabled	ABC / CBA / Disabled
Phase Failure	Disabled	Disabled / Enabled
Overvoltage Alarm	Disabled	1-100% / Disabled
Undervoltage Alarm	Disabled	1-100% / Disabled
Custom Input/Output		
Input #1	Disabled	Refer to Figure #10
Input #2	Disabled	Refer to Figure #10
Output #1	Disabled	Refer to Figure #10
Output #2	Disabled	Refer to Figure #10
Virtual LED #1	Disabled	Refer to Figure #10
Virtual LED #2	Disabled	Refer to Figure #10
Virtual LED #1 Color	Red	Red, Orange, Yellow, Green, Blue
Virtual LED #2 Color	Red	Red, Orange, Yellow, Green, Blue

APPENDIX A: MAIN MENU TREE

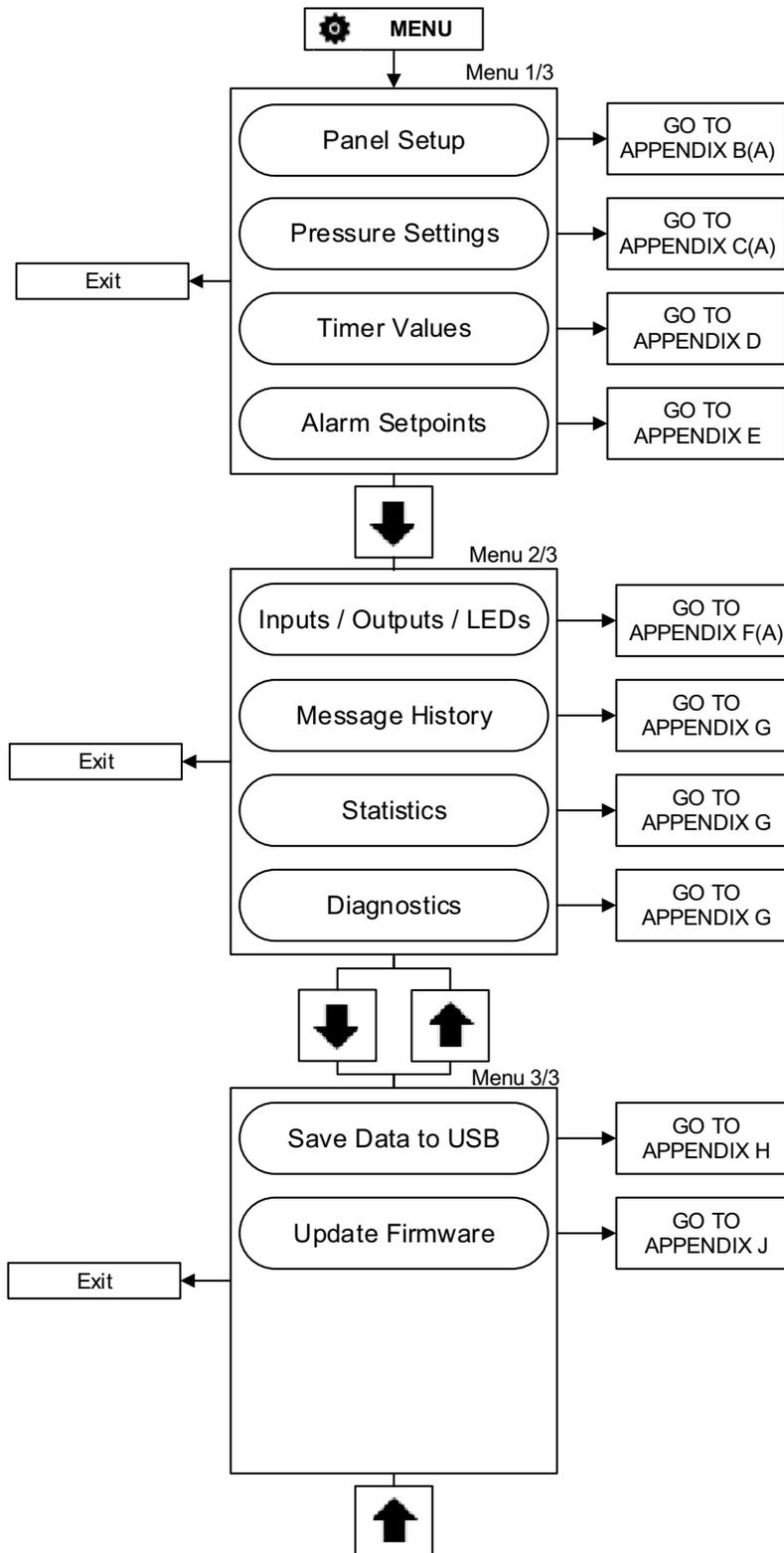

APPENDIX B(A): PANEL SETUP MENU TREE

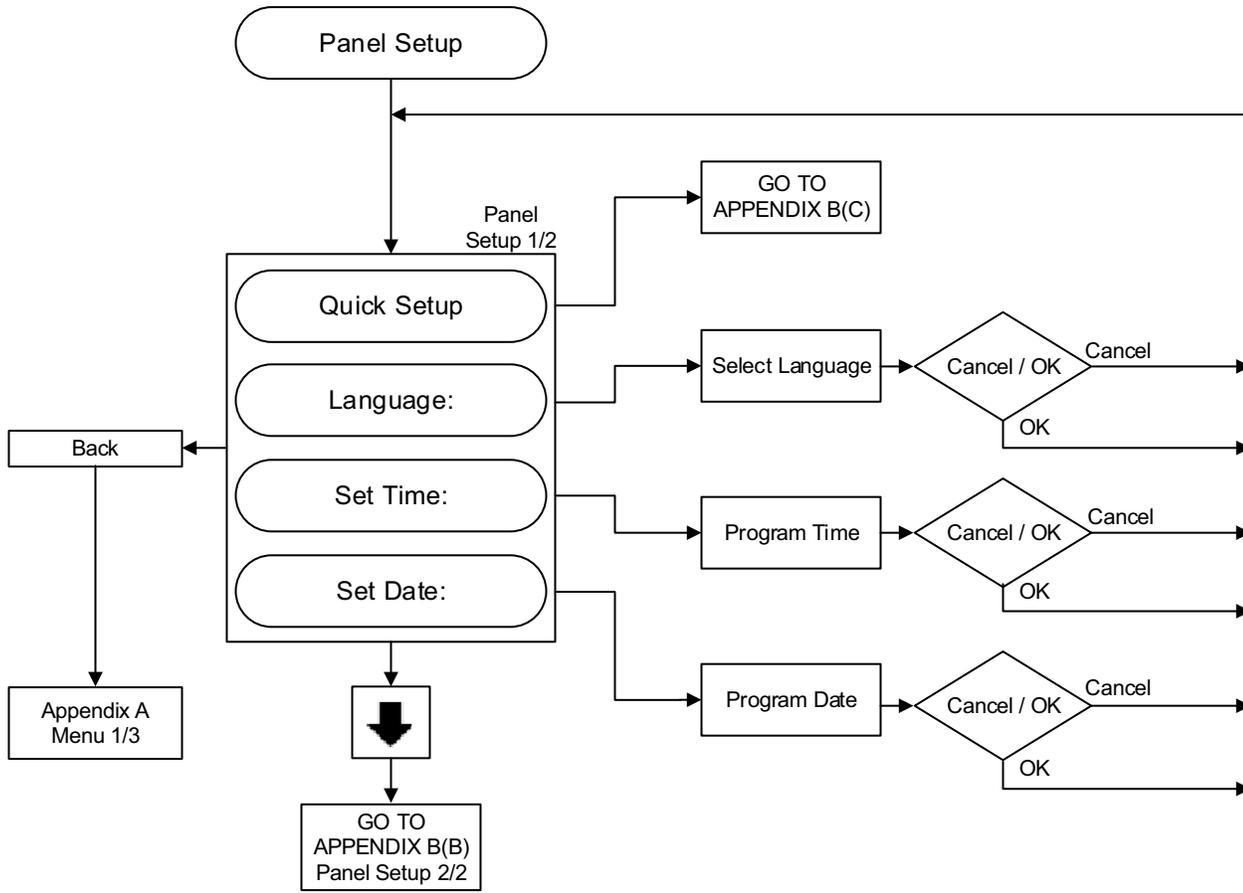

APPENDIX B(B): PANEL SETUP MENU TREE

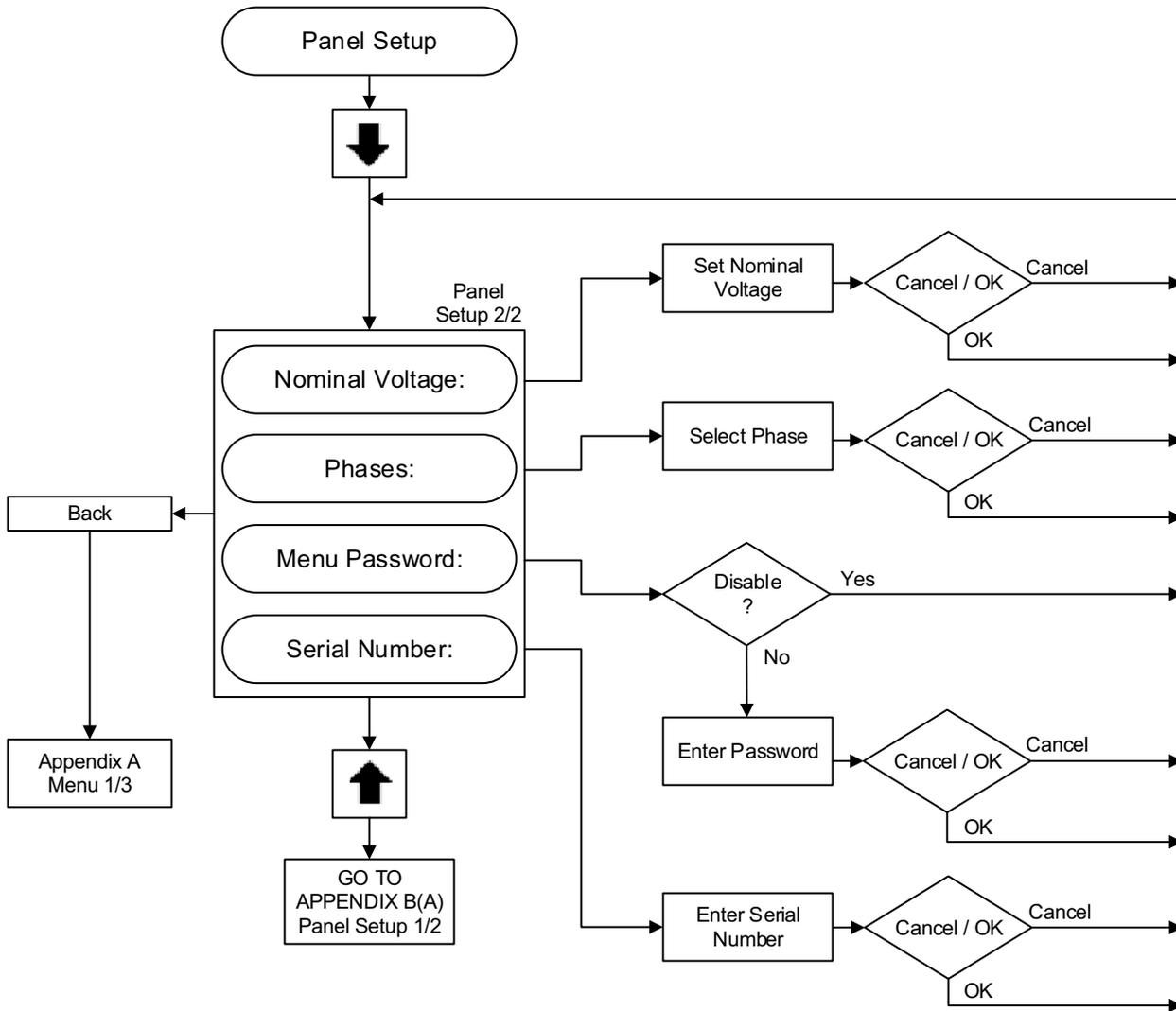

APPENDIX B(C): PANEL SETUP MENU TREE

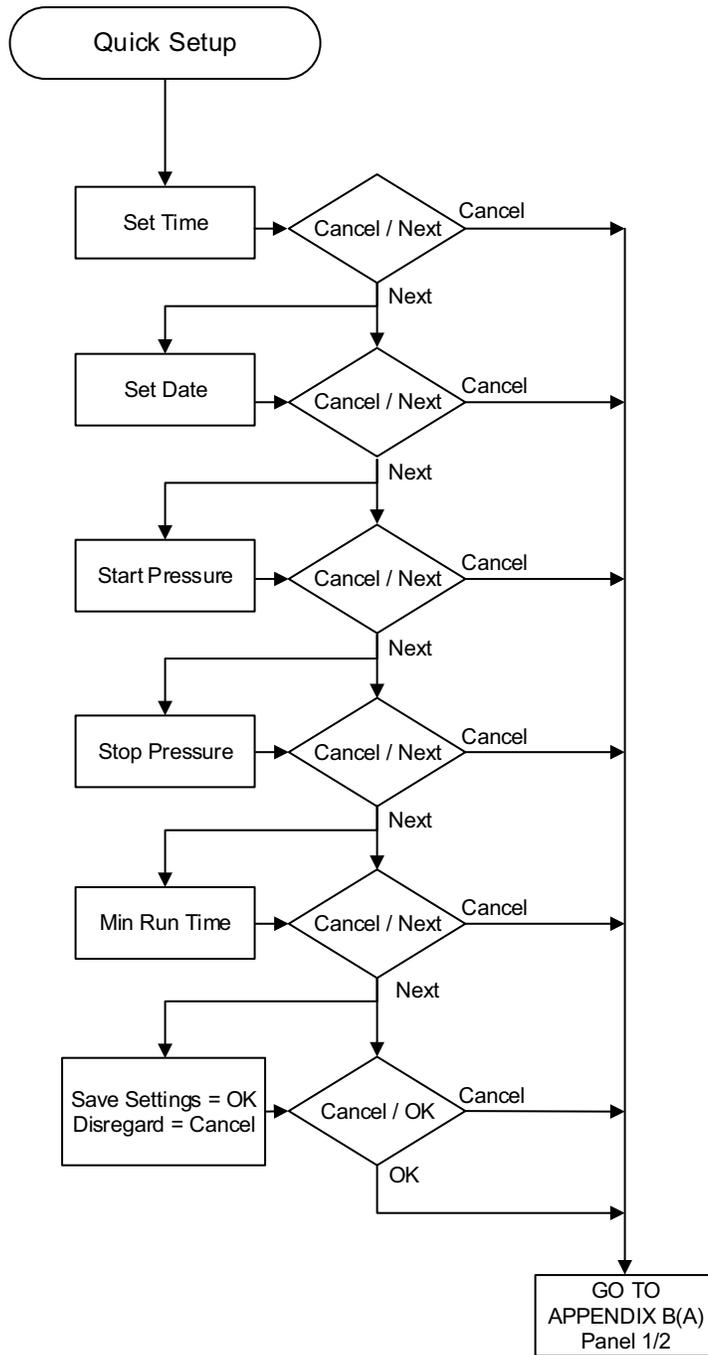

APPENDIX C(A): PRESSURE SETTINGS MENU TREE

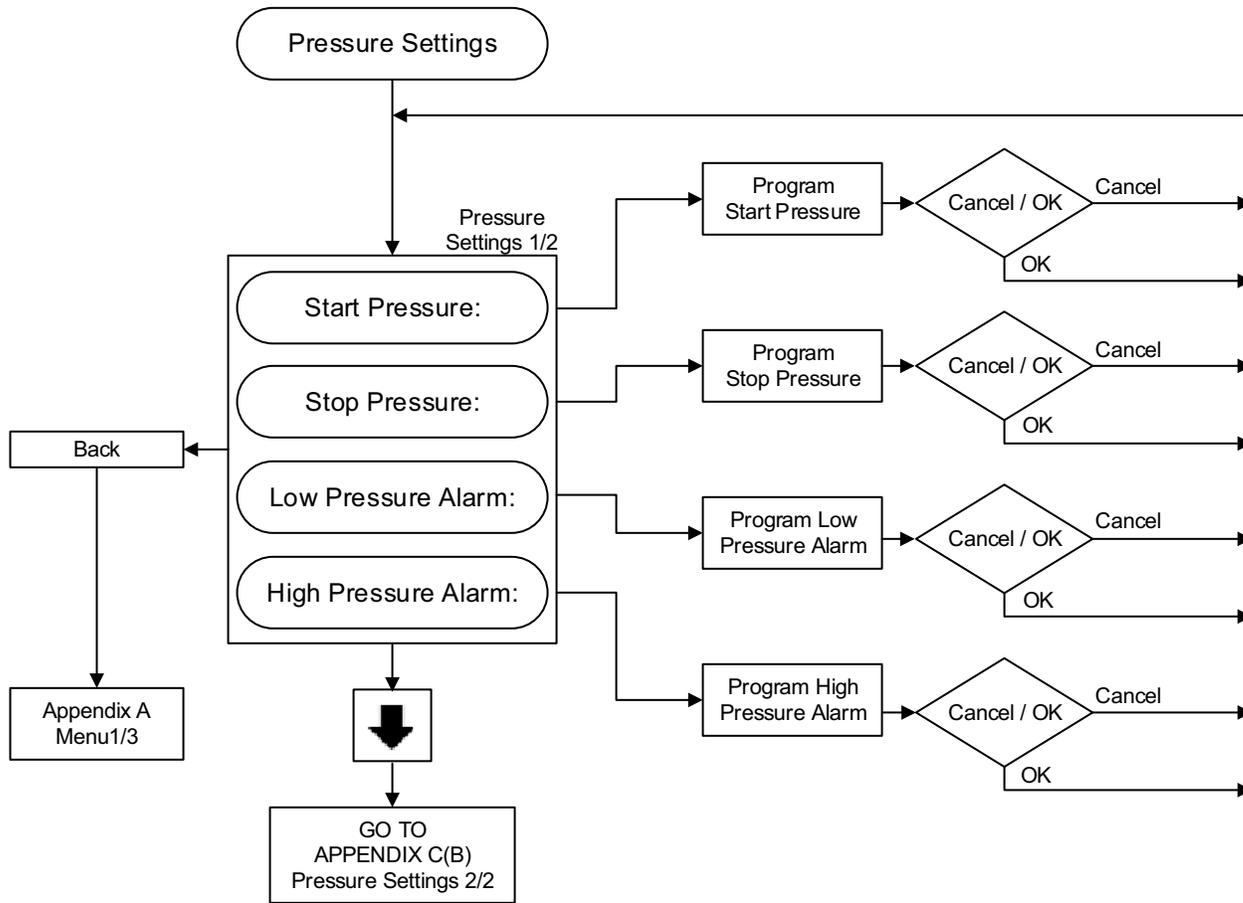

APPENDIX C(B): PRESSURE SETTINGS MENU TREE

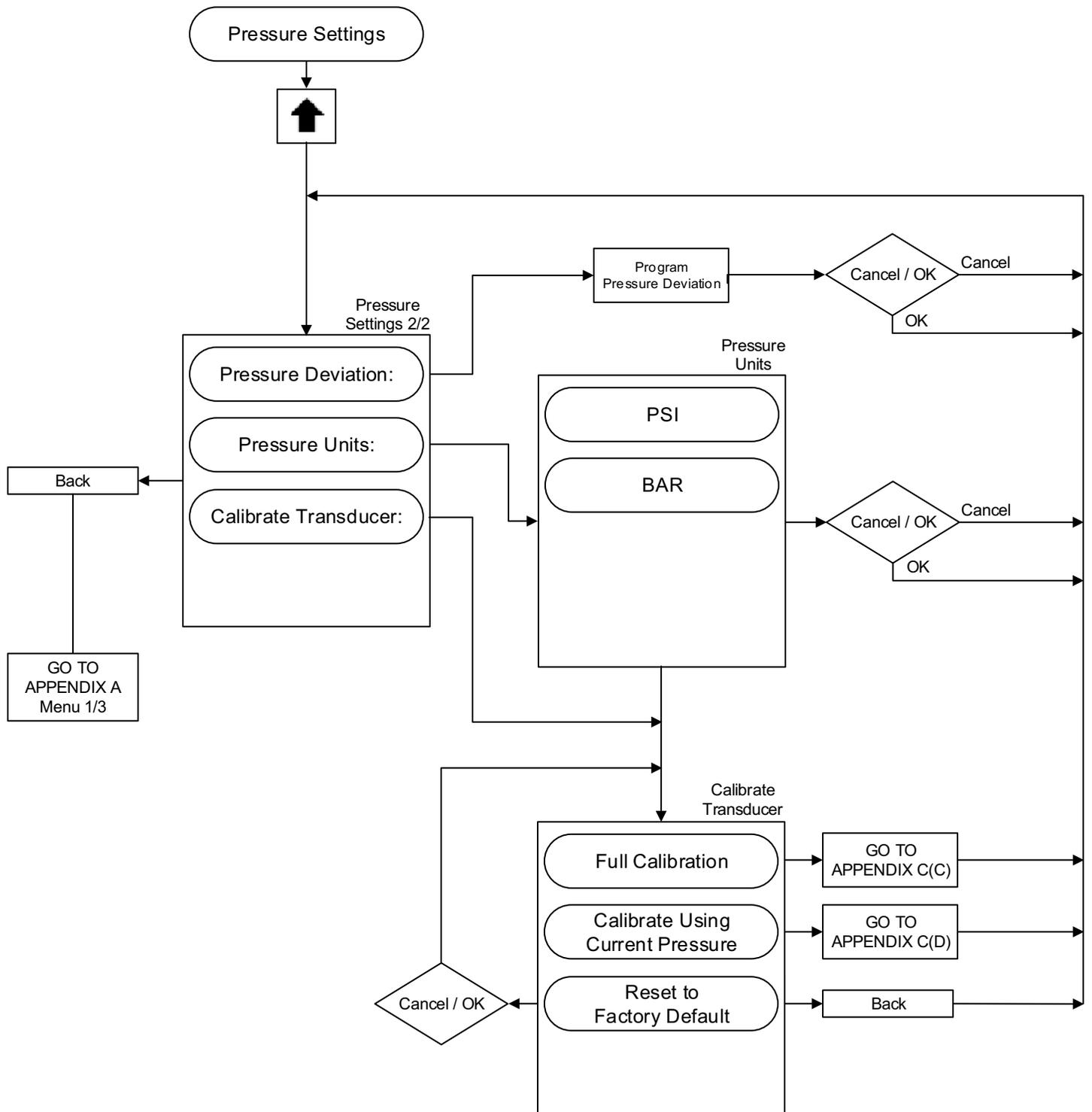

APPENDIX C(C): PRESSURE SETTINGS MENU TREE

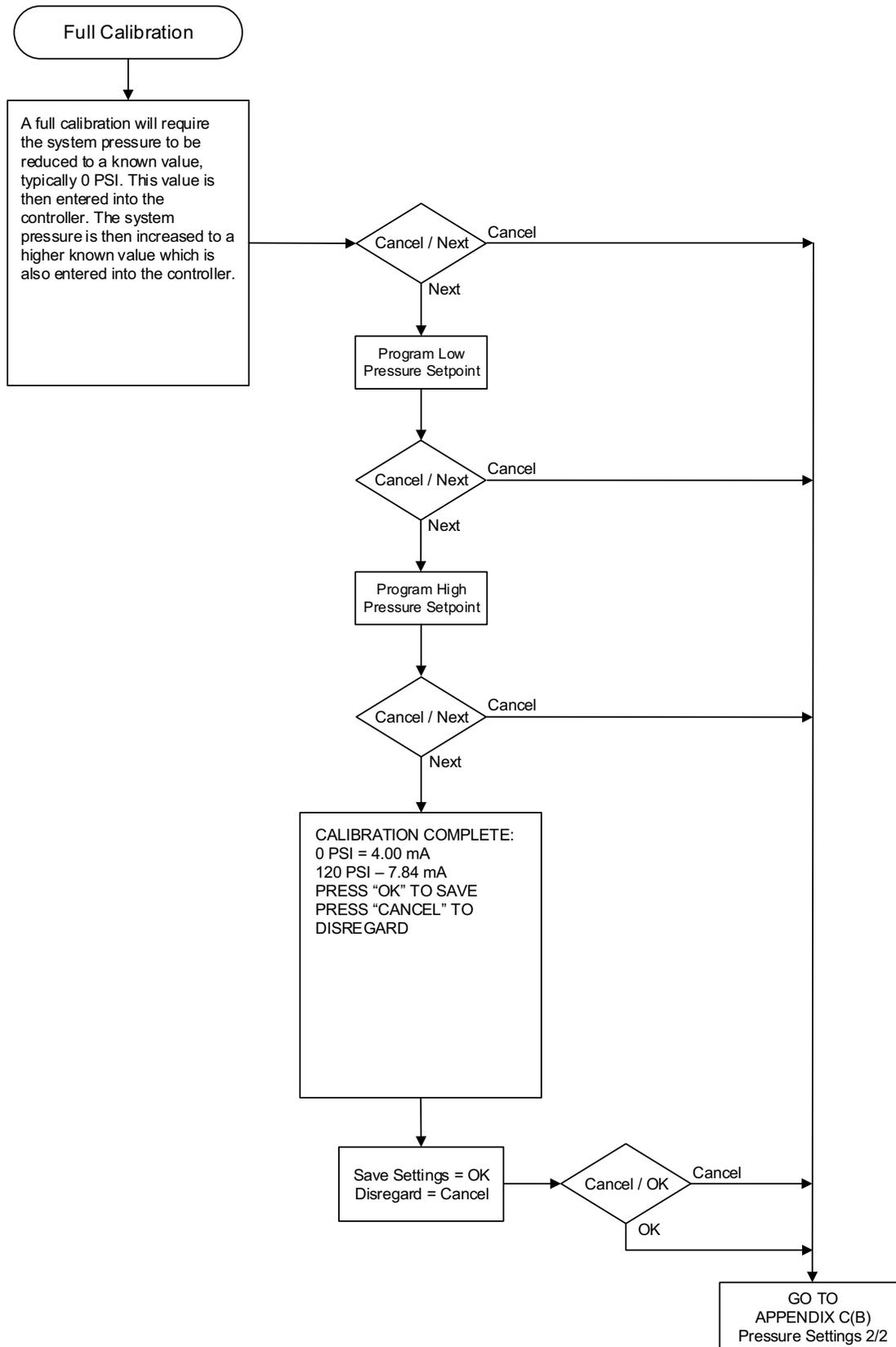

APPENDIX C(D): PRESSURE SETTINGS MENU TREE

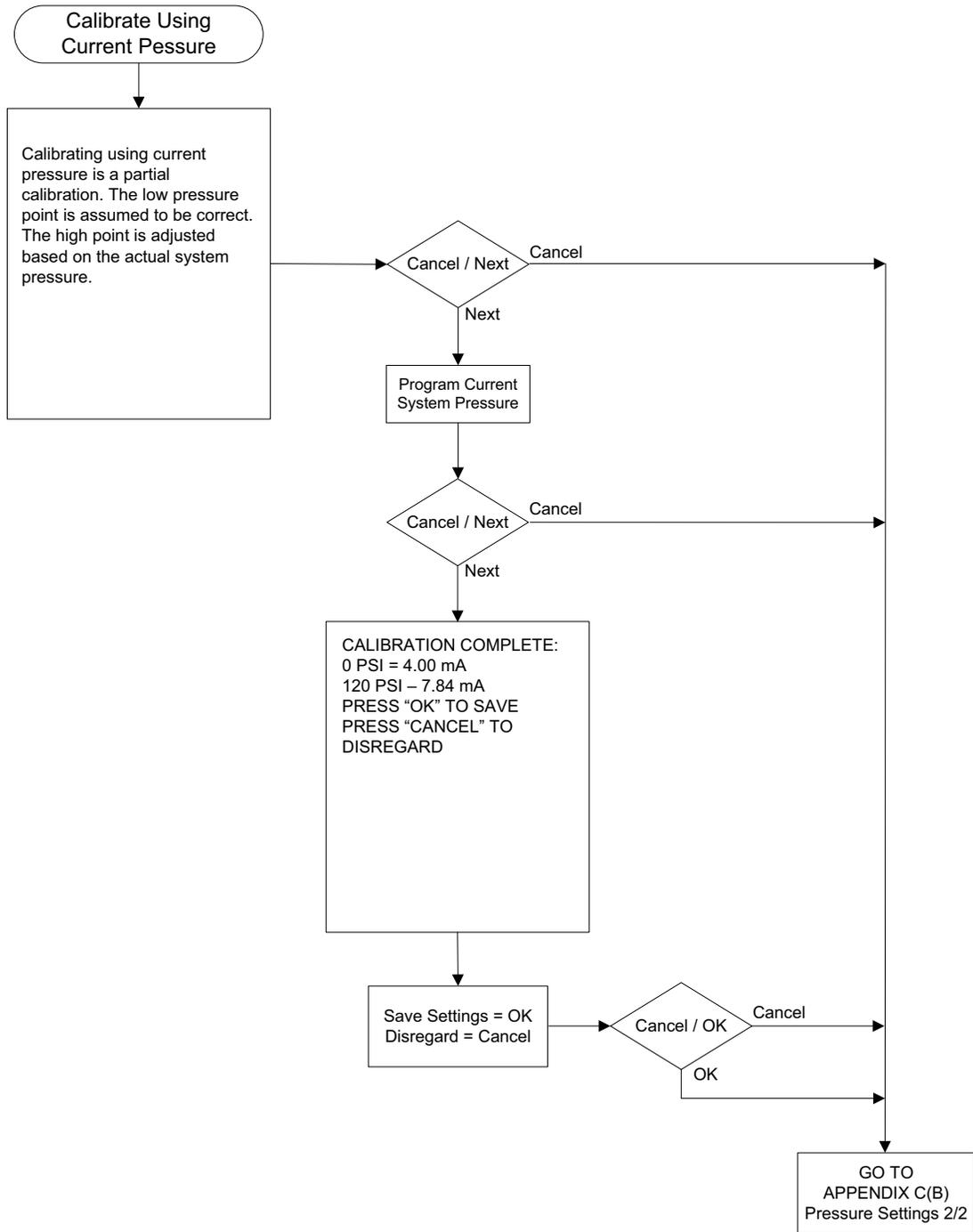

APPENDIX D: TIMER VALUES MENU TREE

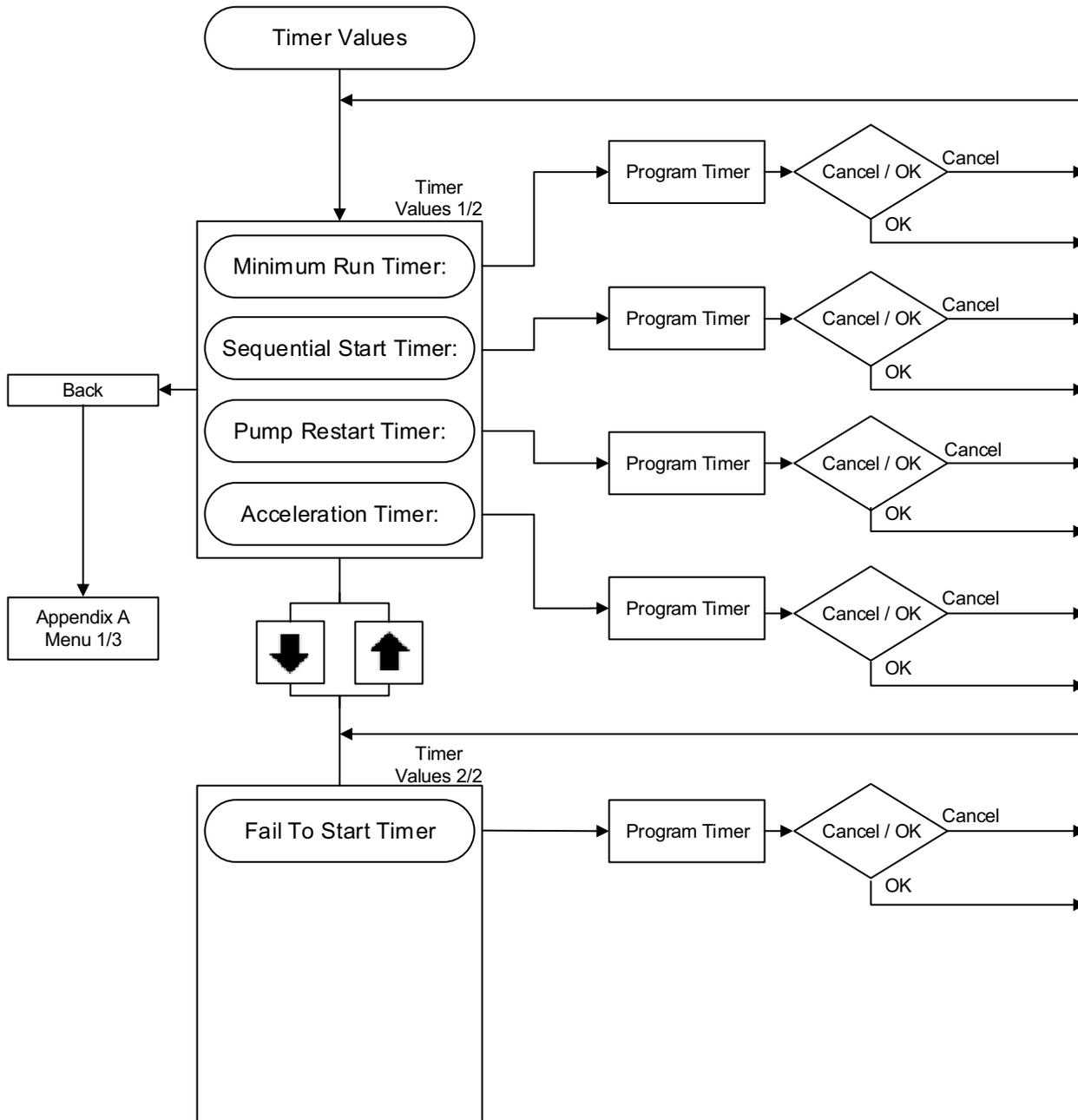

APPENDIX E: ALARM SETPOINTS MENU TREE

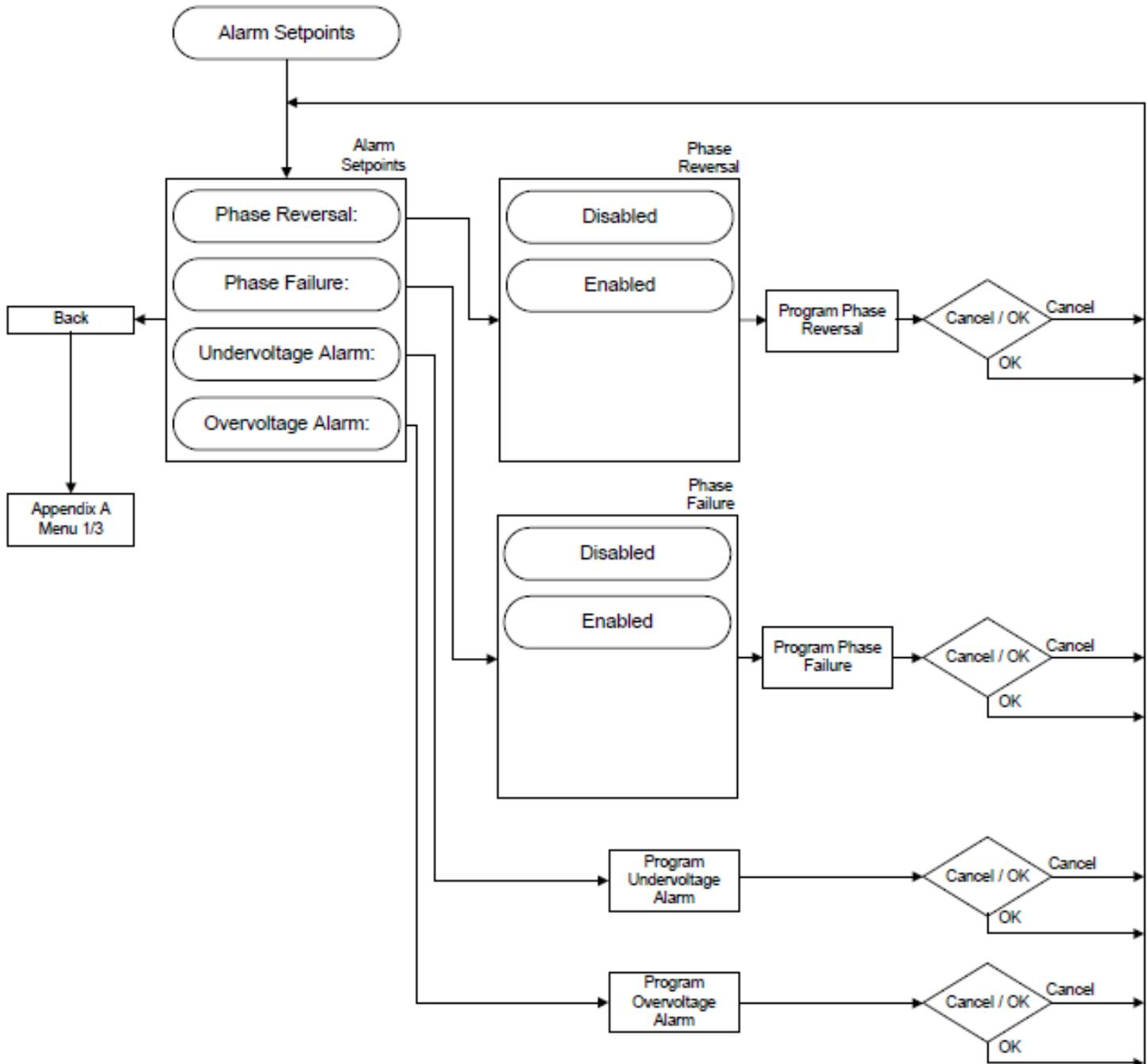

APPENDIX F(A): INPUTS / OUTPUTS / VIRTUAL LEDS MENU TREE

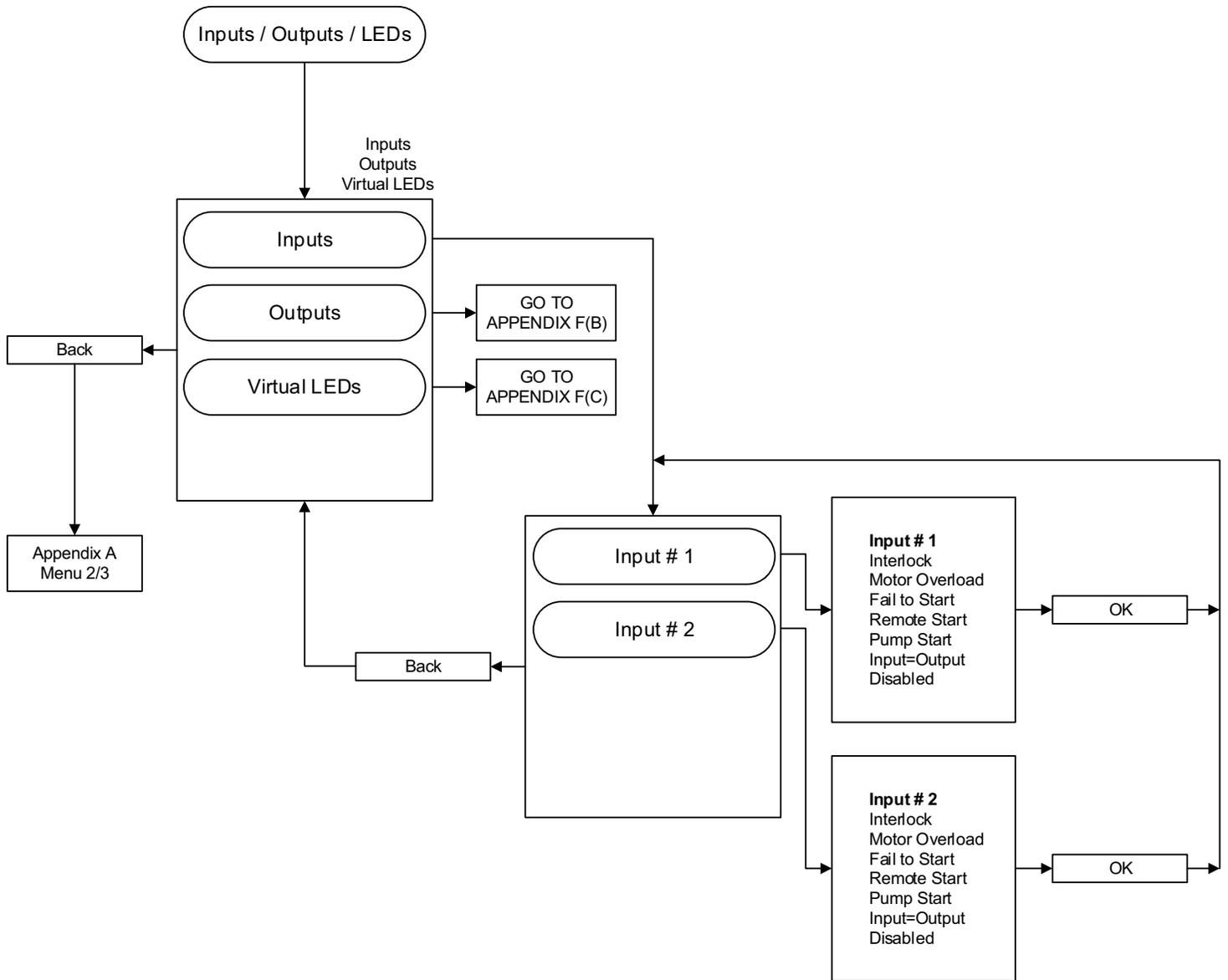

APPENDIX F(B): INPUTS / OUTPUTS / VIRTUAL LEDS MENU TREE

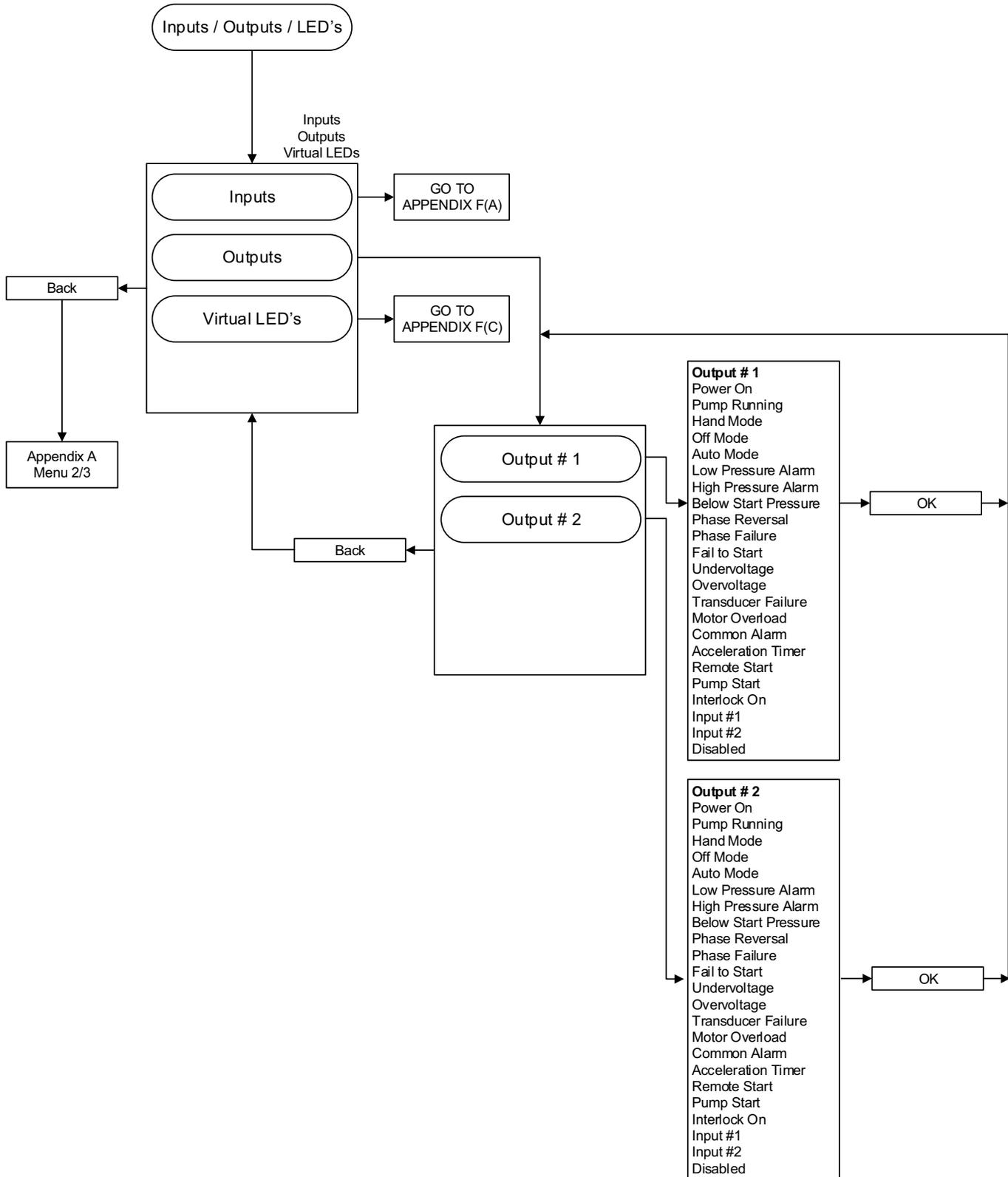

APPENDIX F(C): INPUTS / OUTPUTS / VIRTUAL LEDS MENU TREE

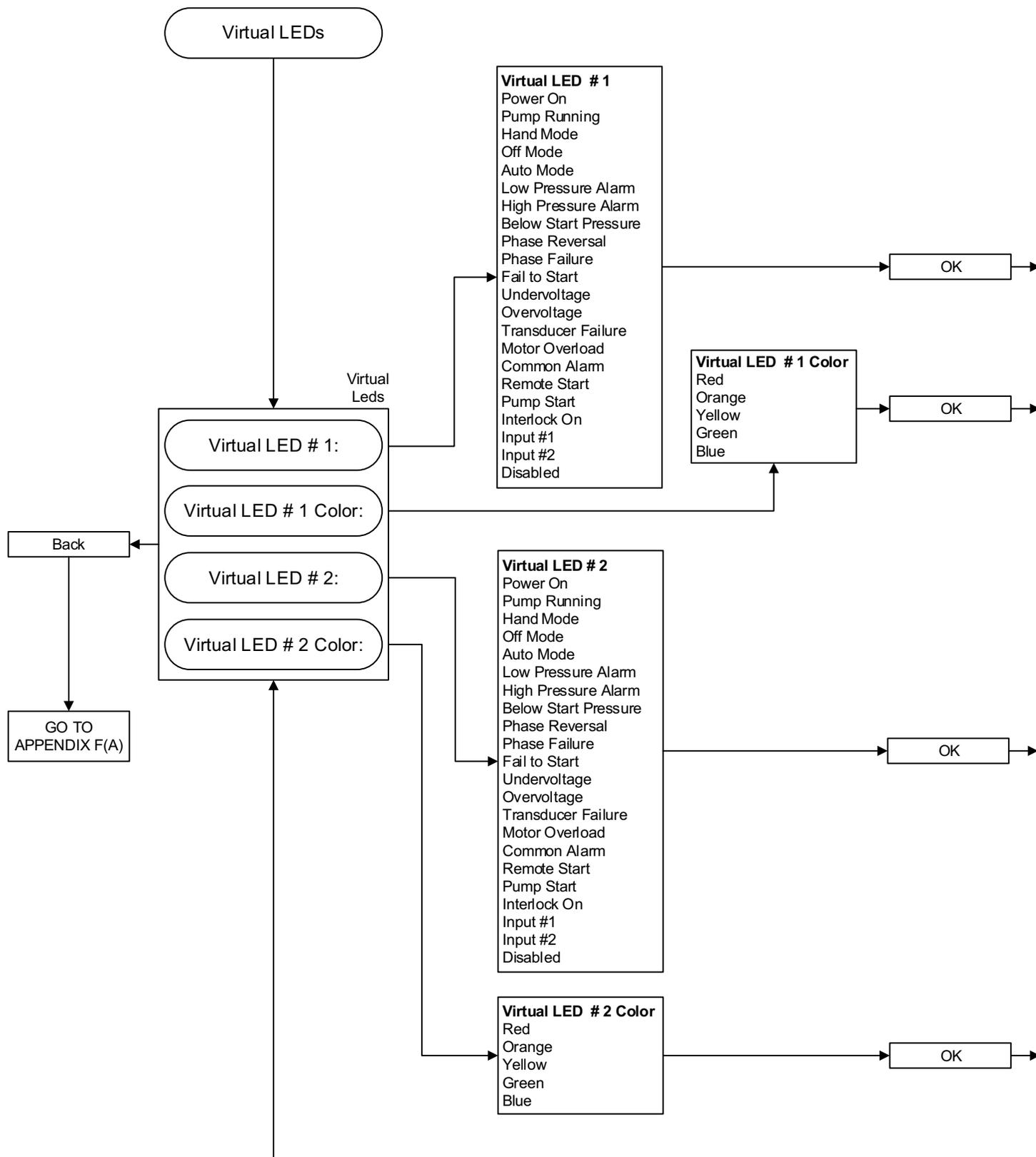

APPENDIX G: MESSAGE HISTORY / STATISTICS / DIAGNOSTICS MENU TREE

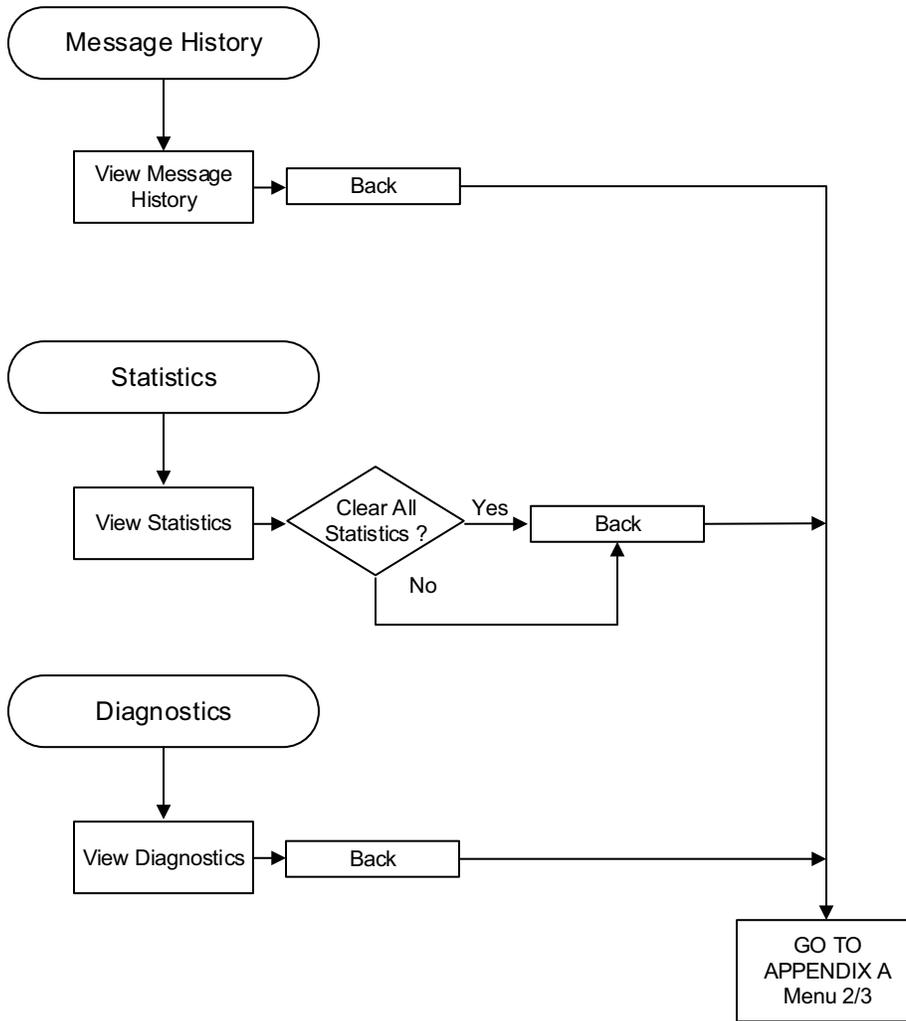

APPENDIX H: SAVE DATA TO USB MENU TREE

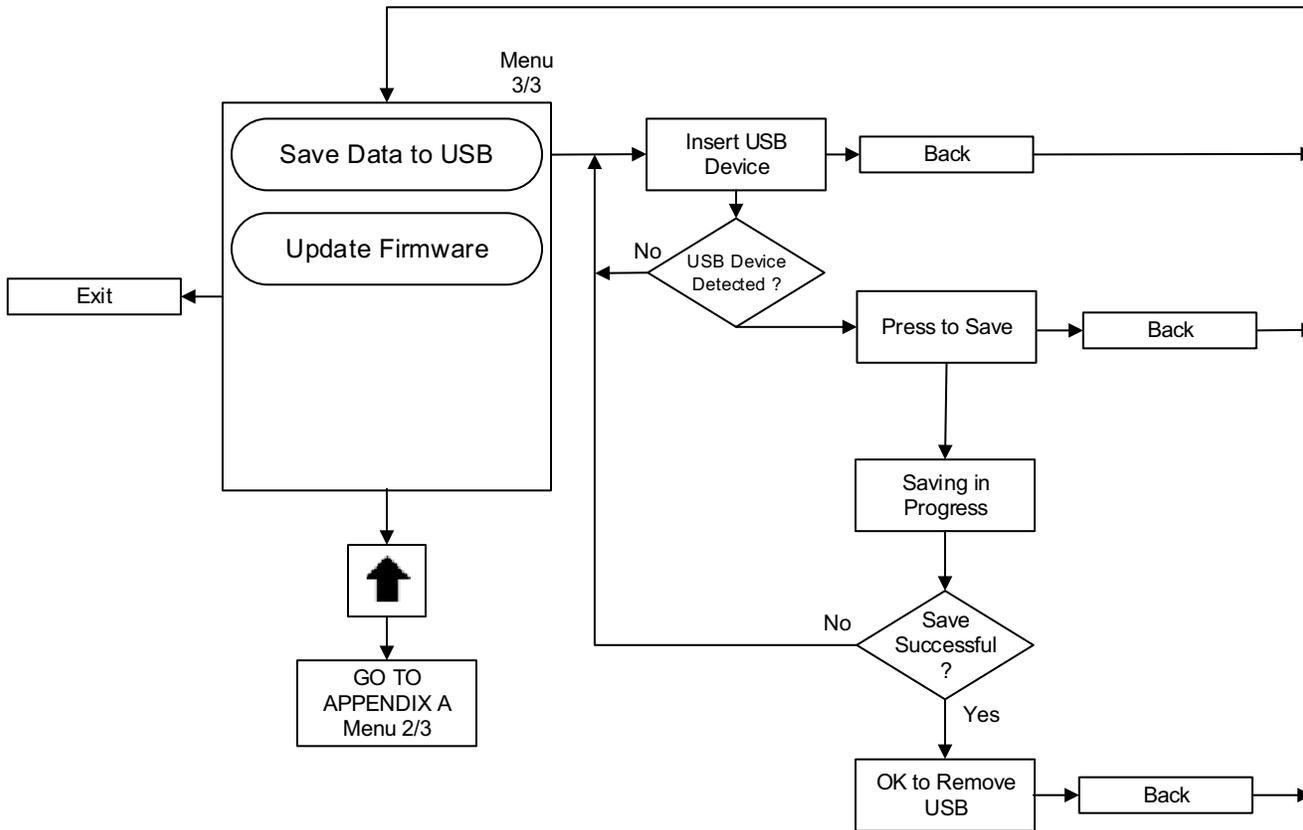

APPENDIX J: UPDATE FIRMWARE MENU TREE

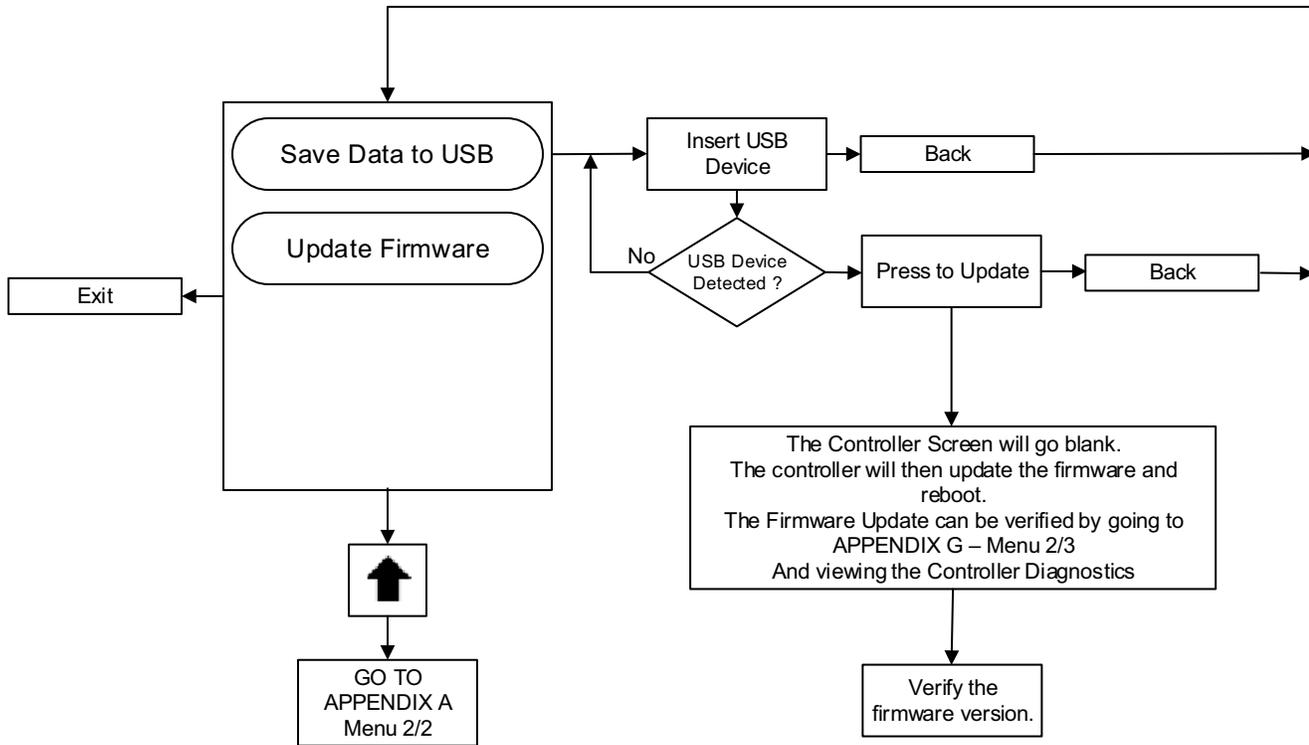

This information booklet is published solely for information purposes and should not be considered all inclusive.

If further information is required, you should consult EATON.

Sale of product shown in this literature is subject to terms and conditions outlined in appropriate EATON selling policies or other contractual agreement between the parties. This literature is not intended to and does not enlarge or add to any such contract. The sole source governing the rights and remedies of any purchaser of this equipment is the contract between the purchaser and EATON.

NO WARRANTIES, EXPRESSED OR IMPLIED, INCLUDING WARRANTIES OF FITNESS FOR A PARTICULAR PURPOSE OR MERCHANTABILITY, OR WARRANTIES ARISING FROM COURSE OF DEALING OR USAGE OF TRADE, ARE MADE REGARDING THE INFORMATION, RECOMMENDATIONS AND DESCRIPTIONS CONTAINED HEREIN.

In no event will EATON be responsible to the purchaser or user in contract, in tort (including negligence), strict liability or otherwise for any special, indirect, incidental or consequential damage or loss whatsoever, including but not limited to damage or loss of use of equipment, plant or power system, cost of capital, loss of power, additional expenses in the use of existing power facilities, or claims against the purchaser or user by its information, recommendations and description contained herein.