

Installation and Operation Manual

Lateral Mounting Base (O-ESA-LMB)

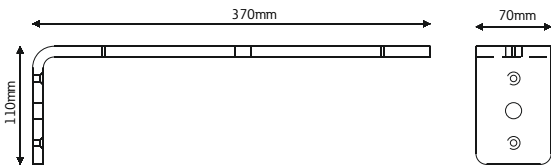

Back Mounting Base (O-ESA-BMB)

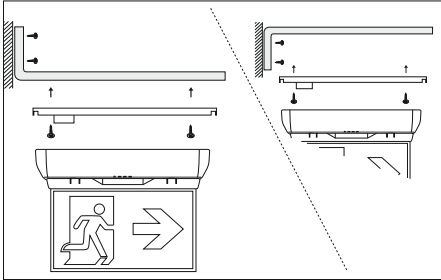
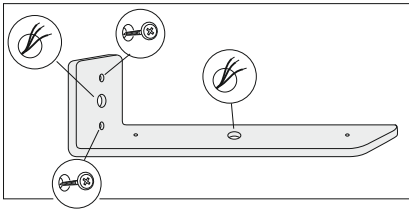
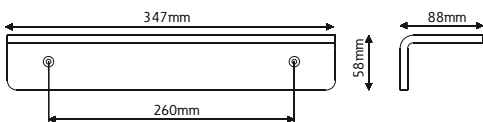
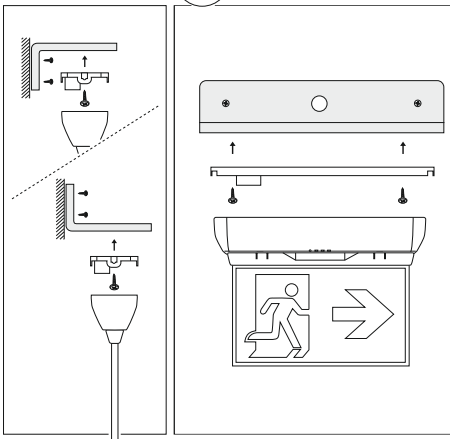
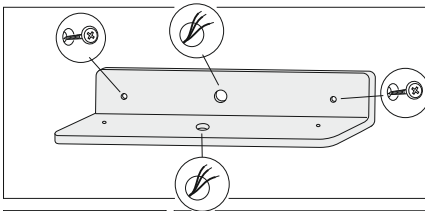

Velos Exit Sign accessories

Recessed Base (O-ESA-RB)

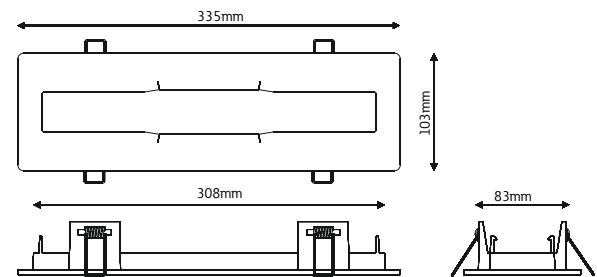
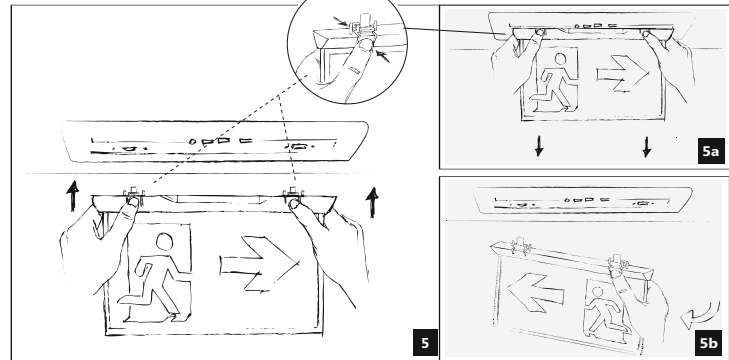
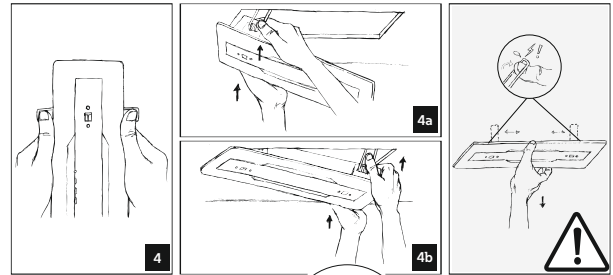
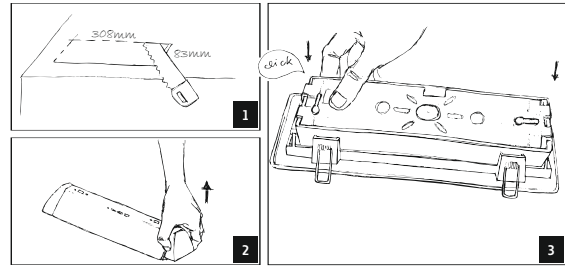

Flexible Joints (O-ESA-FLEX)

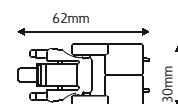
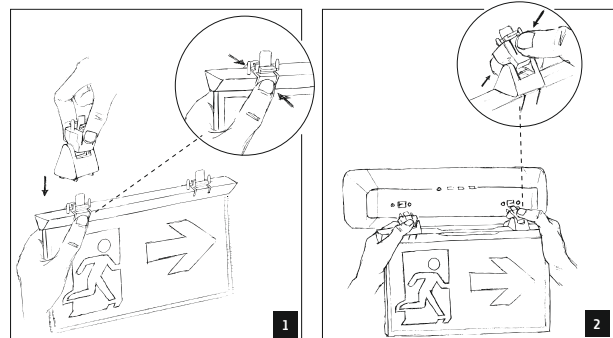

Eaton Industries Manufacturing
Electrical Sector EMEA
Route de la Longeraie 7
1110 Morges, Switzerland
Eaton.eu

Cooper Univel S.A.
Thessalonikis 88
60100 Katerini, Greece

© 2014 Eaton
All Rights Reserved
Printed in EU
Publication No. 1-05-248E
September 2014

Installation and Operation Manual

Rope Suspension (O-ESA-RSA)

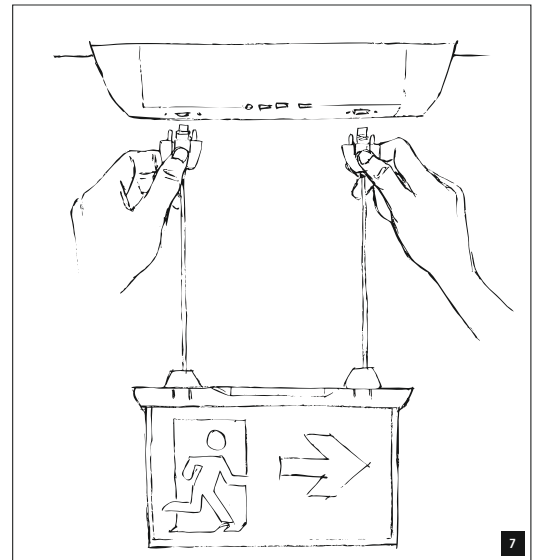
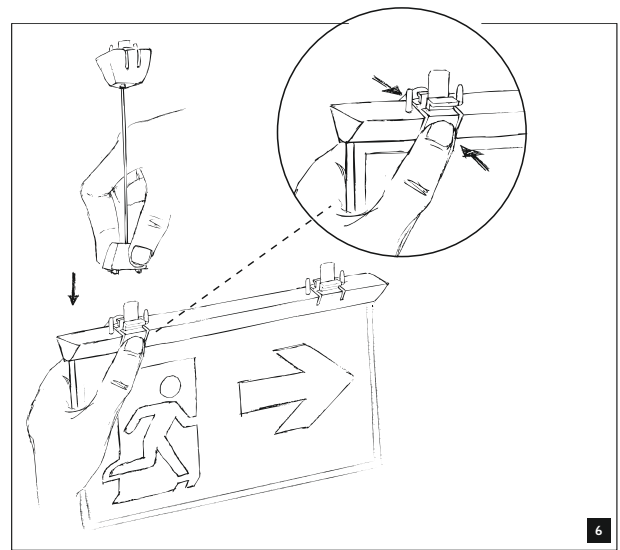
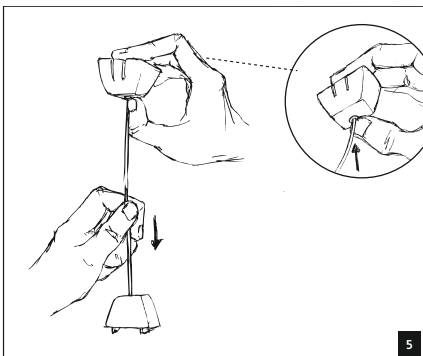
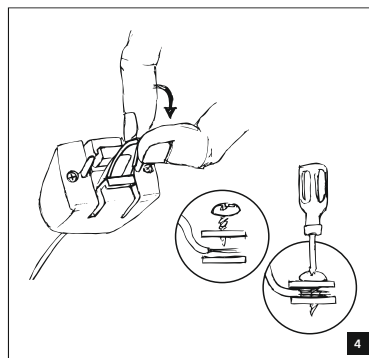
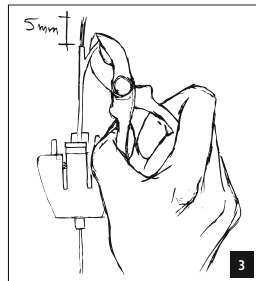
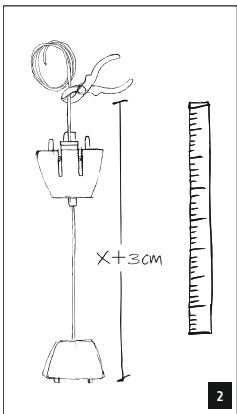
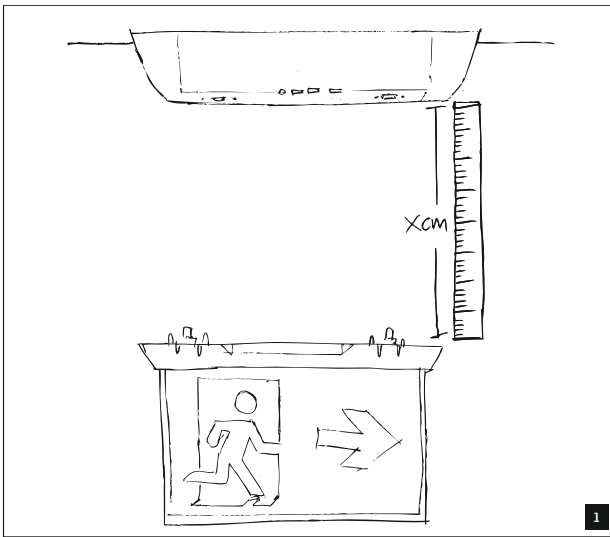

Pipe suspension (O-ESA-PS30)

