

Safety Luminaire

RoundTech MR SEO

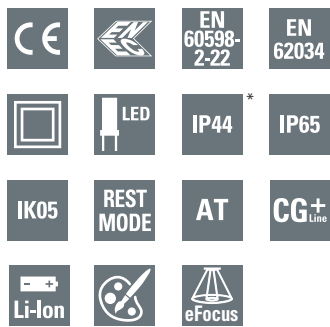

RoundTech MR SEO



Dimensions in mm

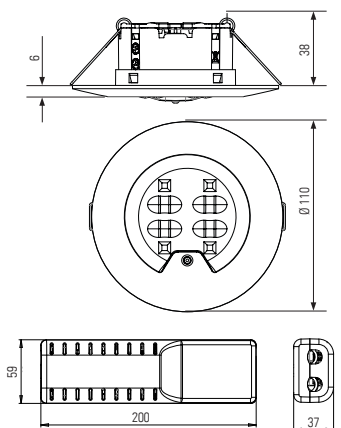

Square trim

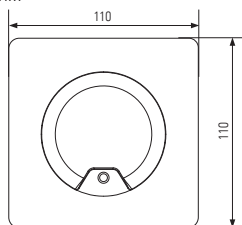

Renovation trim

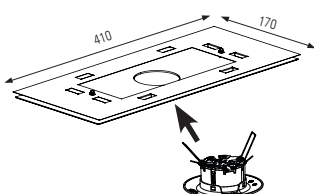

RoundTech Medium Recessed

- LED self-contained safety luminaire
- Installation up to 12m with optimum spacing of 43m for 1lux illumination
 - LowBay: Installation up to 6.5m height
 - HiBay: Installation up to 12m height
- eFocus programming: narrow and wide light distribution, programmed by the user
 - One product applicable for Escape Route or Open Area illumination
 - User / installer to define light distribution to fit the application
- Suitable for use in cinemas, theatres, shopping malls, industrial units, healthcare or hotels
- Automatic test for reduced inspection effort in autonomous installation or connection to CGLine+
- Simple fault analysis and status display via bicolor LED
- Selectable operation mode (Maintained or Non-Maintained) via switch or external contact
- Brightness selectable in mains operation (60lm) via magnet with additional setting (30%, 70%, 100%)
- Easy recessed installation via standard hole saw (Ø 64-78mm)
- Low eco footprint thanks to its eco-design, low consumption and lithium battery
- Round or Square trim available for aesthetic customization options and colours

Luminous flux	150lm, 200lm
Operation	Non-Maintained, Maintained / Non-Maintained
Duration	1h or 3h
Testing system	Test by magnet, Automatic Test, CGLine+ and DALI
Connection terminals	up to 1x2.5 mm ² with screw up to 1x2.5 mm ² with screw, removable up to 2x2.5 mm ² screwless pushwire In & Out mains terminals (L, N, E) CGLine+ bus through-wiring up to 2,5 mm ²
Rated voltage	220-240 V AC, 50/60 Hz
Housing material	Polycarbonate (850 °C glow wire resistant)
Housing colour	White RAL9003 (custom color variants available)
Insulation Class	Class II
Color Rendering Index	R70
Color Temperature	5700K
Light source	4 LEDs Escape Route / 4 LEDs Open Area
Permissible ambient temperature	+5°C to +45°C

Ordering details

Order code	Description	Open area	Power	Duration	Lumen	Battery
Stand Alone						
RT2RSO150SA1H	RoundTech Med. Recessed SA NM IP44	Open area	0.6VA/0.3W	1h	150 lm	LiFePO4 3.2V / 1.5Ah
Auto-test						
RT2RSEO200ATF1HIP	RoundTech Med. Recessed ATF MNM IP65	✓	1.8VA/1.1W	1h	200 lm	LiFePO4 3.2V / 1.5Ah
CGLine+						
RT2RSEO200CGL1HIP	RoundTech Med. Recessed CGL+ MNM IP65	✓	1.8VA/1.1W	1h	200 lm	LiFePO4 3.2V / 1.5Ah
CGLine+ High bay variant for application up to 12m of height						
RT2RHEO200CGL3HIP	RoundTech Med. Recessed CGL+ MNM IP65	✓	1.8VA/1.1W	3h	200 lm	LiFePO4 3.2V / 3Ah
DALI						
RT2RSEO200DMP3HIP	RoundTech Med. Recessed DALI MNM IP65	✓	1.8VA/1.1W	3h	200 lm	LiFePO4 3.2V / 3Ah

Accessories

		Black mat RAL9005	Dark Grey RAL7015	Silver gloss RAL9007	
⊙	RT2R-RT	Round trim for RoundTech Medium Recessed	RT2R-RTB	RT2R-RTG	RT2R-RTS
⊙	RT2R-ST	Square trim for RoundTech Medium Recessed	RT2R-STB	RT2R-STG	RT2R-STS
⊙	RT2R-RP	Renovation Plate for RoundTech medium Recessed			
⊙	RT2R-BAT1	Battery Pack, LifePO4 3.2V 1.5Ah			
⊙	RT2R-BAT3	Battery Pack, LifePO4 3.2V 3Ah			
⊙	EMN	Eaton Magnet for configuration and tests			

* Degree of protection of the luminaire: IP44 or IP65 (Once installed in the ceiling, the luminaire face is rated IP44 or IP65)
Degree of protection of the module housing: IP20

Safety Luminaire

RoundTech MR SEO



eFocus, Escape Route light distribution, enables installations for corridors, escape routes and maximizes the distance between lighting fixtures. A maximum spacing of up to 43m between luminaires reduces the number of required light points and an application range from 2.5m up to 12m for 1Lux, enables mounting at the normally occurring heights.

RoundTech MR Escape Route light distribution

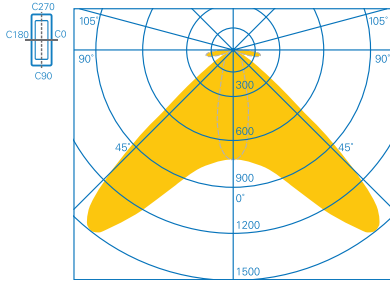

Ceiling mounting,
Escape Route, HiBay

HiBay - Planning help for RoundTech 1.0 lx / 0.5lx

Maintenance factor MF = 94 %, battery operation, ceiling mounting and distances in m

Mounting height [m]	Lux level directly under				
2,5	23,1	2,1 (2,6)	5,1 (6,0)	3,6 (4,1)	8,1 (9,0)
3,0	16,0	2,1 (2,8)	5,6 (6,7)	4,0 (4,6)	9,1 (10,3)
3,5	11,8	2,1 (2,9)	5,9 (7,2)	4,4 (5,1)	10,1 (11,4)
4,0	9,0	2,1 (3,0)	6,0 (7,7)	4,9 (5,5)	11,0 (12,5)
5,0	5,8	2,1 (3,0)	6,0 (8,3)	5,6 (6,3)	12,7 (14,4)
6,0	4,0	2,0 (2,9)	5,9 (8,6)	6,4 (7,1)	14,3 (16,1)
7,5	2,6	1,9 (2,9)	5,8 (8,4)	7,5 (8,3)	16,5 (18,6)
9,0	1,8	1,9 (2,8)	5,6 (8,3)	8,5 (9,4)	18,9 (21,0)
10,0	1,4	1,6 (2,7)	5,5 (8,3)	9,0 (10,2)	20,4 (22,5)
11,0	1,2	1,4 (2,7)	5,4 (8,2)	9,3 (10,9)	21,8 (24,0)
12,0	1,0	0,4 (2,7)	5,3 (8,1)	9,3 (11,5)	23,1 (25,5)

Ceiling mounting
Escape route
center
200lm HiBay

RoundTech MR Escape Route light distribution

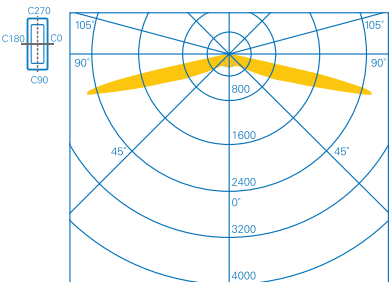

Ceiling mounting,
Escape Route, LowBay

LowBay - Planning help for RoundTech 1.0 lx / 0.5lx

Maintenance factor MF = 94 %, battery operation, ceiling mounting and distances in m

Mounting height [m]	Lux level directly under				
2,5	7,7	1,9 (2,3)	4,7 (5,9)	8,9 (9,8)	19,5 (21,1)
3,0	5,4	2,1 (2,5)	5,0 (6,3)	10,0 (11,2)	22,4 (24,3)
3,5	3,9	2,3 (2,7)	5,4 (6,6)	11,0 (12,5)	25,0 (27,4)
4,0	3,0	2,4 (2,9)	5,8 (6,9)	11,5 (13,7)	27,4 (30,4)
5,0	1,9	2,4 (3,2)	6,4 (7,6)	8,8 (15,6)	30,4 (35,7)
6,0	1,3	2,1 (3,4)	6,8 (8,4)	2,9 (16,1)	26,6 (40,2)

* Spacing tables above are examples of performance of certain models with specific lumen output, installed on ceiling and specific heights. Complete performance characteristics for all models and all installation heights and can be derived by the use of the LDT files available on request.



Escape route for 1 lux

Points of emphasis

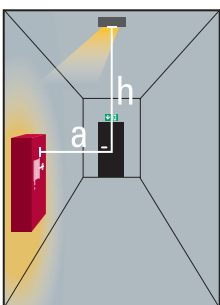

200lm with maintenance factor 0.94

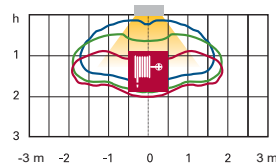

400lm with maintenance factor 0.94

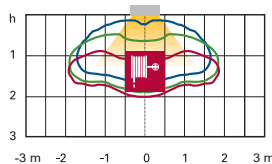

Area in which a minimum illuminance of 5lx is achieved, depending on distance a and the rated operating time:

a = 2.0 m SE

a = 1.5 m SE

a = 1.0 m SE

Rotation during application of the light head is required in order to illuminate safety points.

Safety Luminaire

RoundTech MR SEO



RoundTech MR
Escape Route light distribution

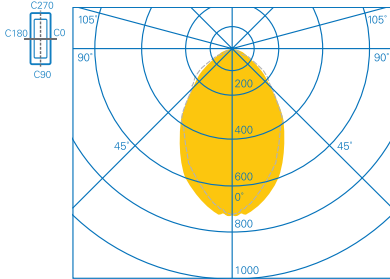

Ceiling mounting,
Open area, HiBay

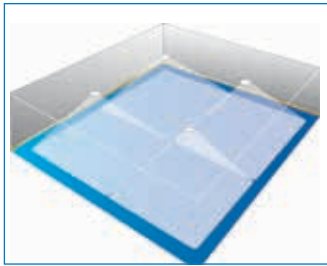

Open area for 0.5 lux

Points of emphasis

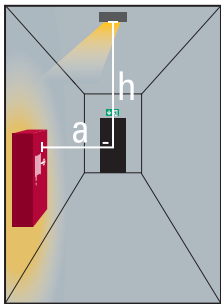

200lm with maintenance factor 0.94

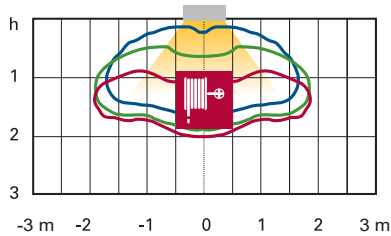

400lm with maintenance factor 0.94

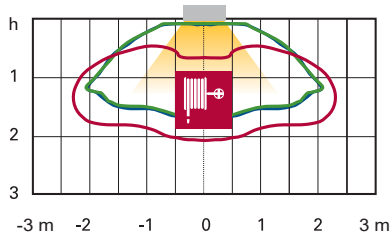

Area in which a minimum illuminance of 5lx is achieved, depending on distance a and the rated operating time:

a = 2.0 m SO

a = 1.5 m SO

a = 1.0 m SO

Rotation during application of the light head is required in order to illuminate safety points.

HiBay - Planning help for RoundTech 1.0 lx / 0.5lx

Maintenance factor MF = 94 %, battery operation, ceiling mounting and distances in m

Luminaire type	Height (m)	Distance for 1 lx (0.5 lx)			
Ceiling mounting Room illumination 200lm HiBay	2,5	2,5 (2,9)	6,4 (7,8)	2,5 (2,8)	6,5 (7,8)
	3,0	2,7 (3,2)	7,0 (8,5)	2,6 (3,0)	7,0 (8,4)
	3,5	2,8 (3,3)	7,5 (9,1)	2,8 (3,2)	7,5 (9,1)
	4,0	2,9 (3,5)	8,0 (9,7)	2,9 (3,4)	7,9 (9,6)
	5,0	3,0 (3,8)	8,7 (10,7)	3,1 (3,7)	8,7 (10,6)
	6,0	3,2 (3,9)	9,4 (11,5)	3,2 (4,0)	9,4 (11,5)
	7,5	3,1 (4,2)	10,0 (12,6)	3,1 (4,3)	10,2 (12,6)
	9,0	2,8 (4,4)	10,0 (13,6)	2,7 (4,3)	10,8 (13,5)
	10,0	2,5 (4,2)	11,0 (14,1)	2,4 (4,3)	11,1 (14,1)
	12,0	2,2 (4,1)	11,0 (14,6)	1,9 (4,1)	11,2 (14,6)
15,0	1,5 (3,7)	11,0 (15,2)	0,5 (3,7)	11,4 (15,3)	
20,0	0,5 (3,2)	10,0 (15,8)	0,5 (2,7)	10,4 (15,7)	
25,0	0,5 (1,9)	8,2 (15,7)	0,5 (0,7)	8,1 (16,1)	
30,0	0,5 (1,2)	6,0 (14,7)	0,5 (0,5)	6,1 (15,2)	

* Spacing tables above are examples of performance of certain models with specific lumen output, installed on ceiling and specific heights. Complete performance characteristics for all models and all installation heights and can be derived by the use of the LDT files available on request.

Safety Luminaire

RoundTech MR SEO

RoundTech MR Open area light distribution

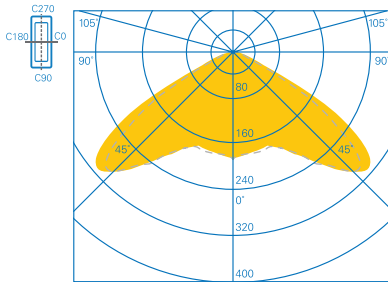

Ceiling mounting,
Open area, LowBay

LowBay - Planning help for RoundTech 1.0 lx / 0.5lx

Maintenance factor MF = 94 %, battery operation, ceiling mounting and distances in m

Luminaire type	Height (m)	Distance for 1 lx (0.5 lx)			
Ceiling					
Ceiling mounting Room illumination 200lm LowBay	2,5	3,9 (4,6)	8,9 (10,0)	3,9 (4,6)	9,2 (10,3)
	3,0	4,1 (5,0)	9,8 (11,3)	4,1 (5,0)	10,1 (11,7)
	3,5	4,1 (5,3)	10,5 (12,5)	4,1 (5,3)	10,9 (13,0)
	4,0	3,5 (5,5)	11,3 (13,5)	3,5 (5,5)	11,7 (14,0)
	5,0	2 (5,6)	12,2 (14,9)	1,9 (5,6)	12,5 (15,5)
	6,0	- (4,1)	- (16,3)	- (4,1)	- (16,8)
	7,5	- (2,5)	- (16,6)	- (2,3)	- (16,9)
Ceiling mounting Room illumination 150lm LowBay	2,5	3,6 (4,3)	8,4 (9,5)	3,6 (4,3)	8,7 (9,8)
	3,0	3,6 (4,6)	9,1 (10,7)	3,6 (4,6)	9,4 (11,1)
	3,5	3 (4,9)	9,9 (11,8)	3 (4,9)	10,2 (12,2)
	4,0	2,2 (4,9)	10,3 (12,5)	2,2 (4,9)	10,4 (13,0)
	5,0	1,1 (4,0)	10,5 (14,0)	0,9 (4,0)	10,4 (14,4)
	6,0	- (2,5)	- (15,0)	- (2,3)	- (15,2)

* Spacing tables above are examples of performance of certain models with specific lumen output, installed on ceiling and specific heights. Complete performance characteristics for all models and all installation heights and can be derived by the use of the LDT files available on request.