

xComfort Room Controller Touch CRCA-00/08 ... CRCA-00/13

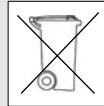
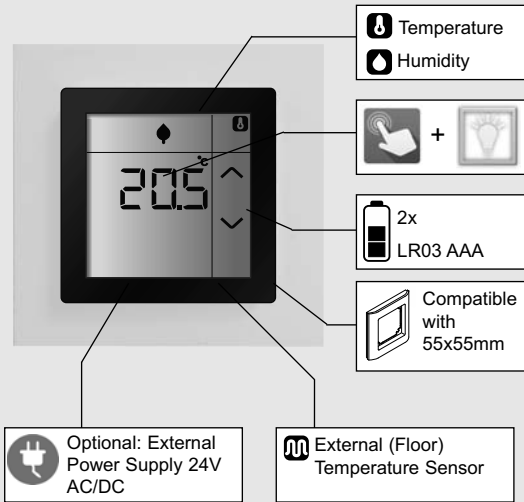

Controller	Type	Color
CRCA-00/08	Temperature, Humidity	Pure white
CRCA-00/09	Temperature, Humidity	Anthracite
CRCA-00/10	Temperature, Humidity	Traffic white
CRCA-00/11	Temperature, Humidity	Alpine white
CRCA-00/12	Temperature, Humidity	Signal white
CRCA-00/13	Temperature, Humidity	Jet black

Technical Data / Technische gegevens / Tekniske data / Technische Daten / Technická data

Power Supply	
Batteries	3V via 2x LR03 (AAA)
External power supply	12-24 VDC/AC
Internal Temperature sensor	
Range	0 - 40°C
Accuracy	± 0.5°C
External Temperature sensor	
	PT-1000
Humidity sensor	
Relative humidity range	5 - 95%
Accuracy	± 5% rH
Connections	
Stripping length	6 mm
Cross section	
Solid core	0.14 - 0.5 mm ²
Stranded core	0.2 - 0.5 mm ²
Dimensions (H x W x D)	55 x 55 x 21 mm

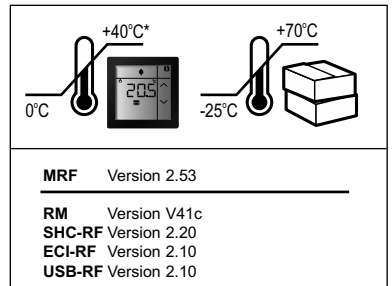

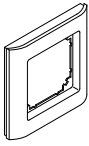

Merten	Gira	Busch Jaeger	Jung	Berker	Siemens	Elko	Kopp
1-M	Standard 55	Carat*	AS	S.1	Delta line	RS16	Alaska
Atelier M	E2	Pur Edelstahl*	A 500	B.1	Delta vita	Plus	
M-Smart	Event	Solo*	A plus	B.3	Delta miro		
M-Arc	Esprit	Future*	A creation	B.7 Glas	Delta profil**		
M-Star	Profil 55	Future linear*					
M-Plan	E22	CZ Future*					
M-Plan II		Busch-balance® SI					
M-Plan Metall							
M-Plan Glas							

* only with intermediate frame Busch&Jäger

** only with intermediate frame Siemens

Mounting / Montage / Montering / Montage / Montáž

1a

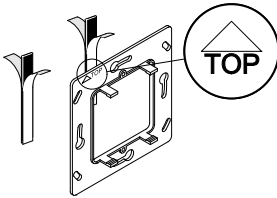

1b

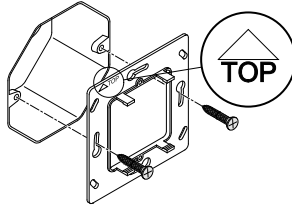

2

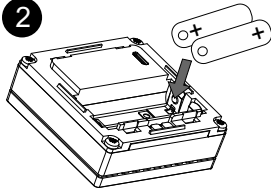

LR03 AAA-Micro 1,5V



3

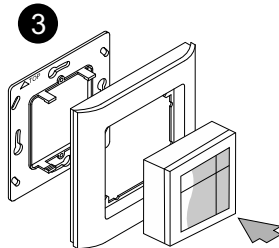

4

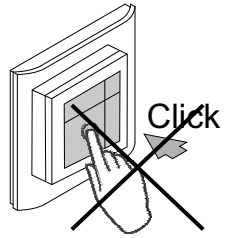
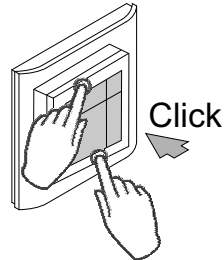

Wiring diagram/ Aansluitschema / Koblingskjemær / Anschlussplan / Schéma zapojení

(Optional / Optioneel / Valgfri / Optional / Volitelné):

- External power supply / Externe voiding/ Ekstern strømforsyning / Externe Stromversorgung / Externí napájení
- (Floor) Temperature sensor / (Vloer) Temperatuur sensor / (Gulv) Temperatur sensor / (Boden) Temperatursensor / (Podlahové) Teplotní čidlo

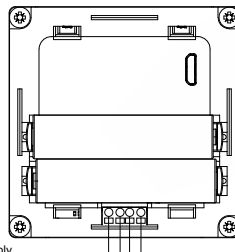
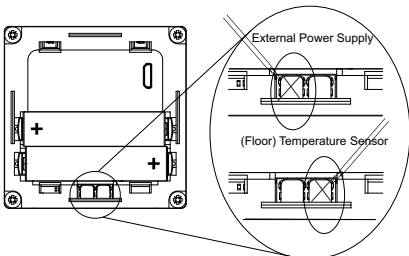

Power Supply
CMMZ-00/12
CMMZ-00/13

Temperature Sensor
CSEZ-01/01
CSEZ-01/36

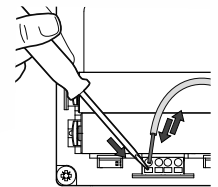

Offset / Offset / Offset / Abgleich / Offset:

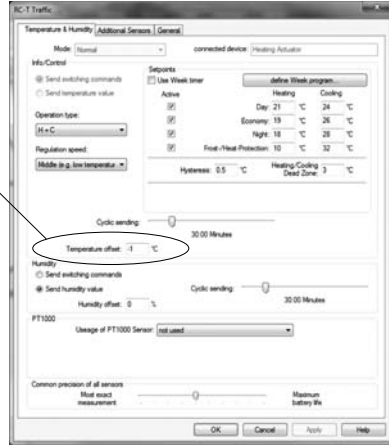
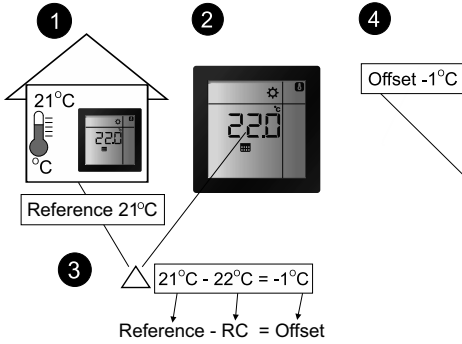

Positioning / Positionering / Plassering / Positionierung / Umístění:

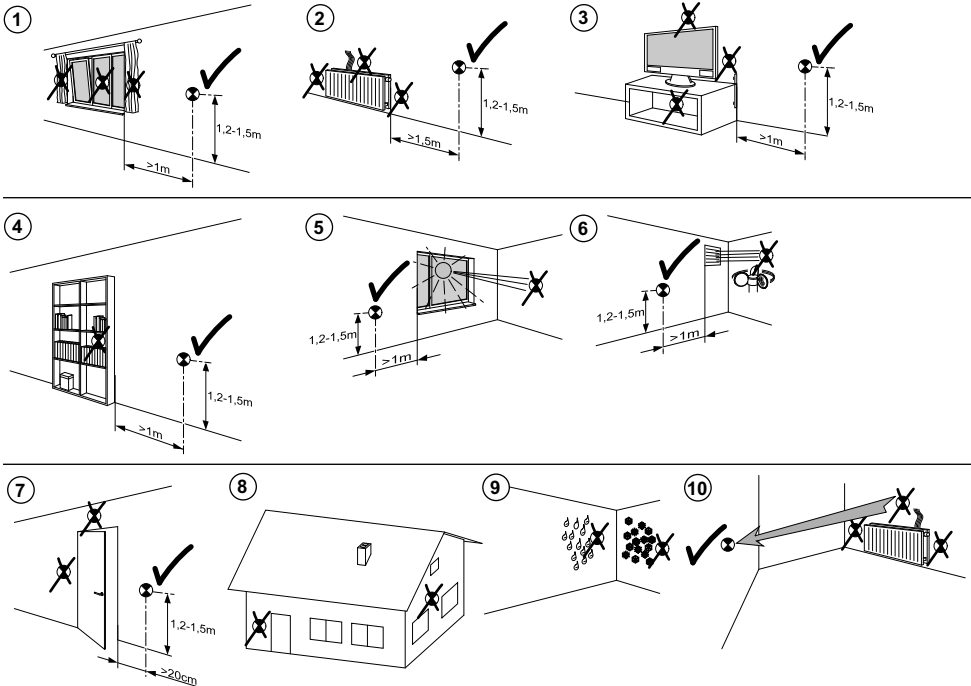

Cleaning / Reinigen / Rengjøring / Reinigung / Čištění:

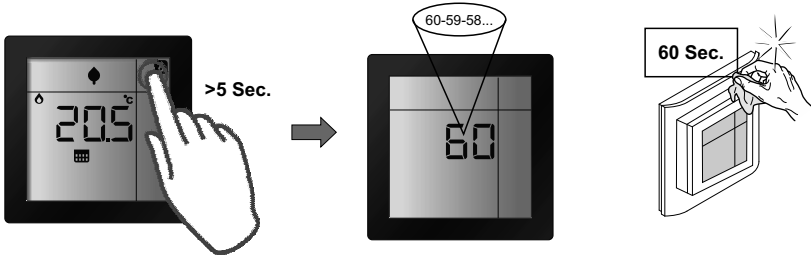

Basic Mode:

Start basic mode / Start basic mode / Start Basic Mode / Starte Basic Mode / Spustit základní režim

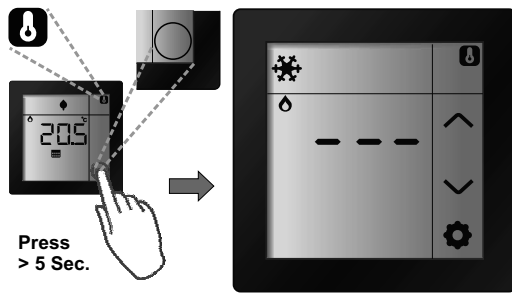

Press
> 5 Sec.

Back to factory default /
Terug naar fabriekinstellingen /
Tilbake til fabrikkinstillingen /
In Auslieferungszustand zurücksetzen /
Obnovit tovární nastavení

Assign or Remove device /
Apparaat toewijzen of verwijderen /
Tildele eller fjerne enheten /
Zuweisen oder Entfernen von Geräten /
Přifažení nebo odebrání zařízení

Stop basic mode or cancel operation /
Stop basic mode of actie annuleren /
Stopp basic mode eller avbryte operasjonen /
Stoppe Basic mode oder Vorgang abbrechen /
Ukončit základní režim nebo zrušit operaci

Select Device / Selecteer apparaat / Velg enhet /
Gerät auswählen / Vybrat zařízení

Device; Function; Type / Apparaat; Functie; Type / Enhet; Funksjon; Type / Gerät; Funktion; Typ / Zařízení; funkce; typ

Heating; Heating Actuator / Verwarming; Verwarmingsactor / Oppvarming; Varmeaktuator /
Heizung; Heizungsaktor / Topení; Aktor topení

Heating; On/Off Actuator / Verwarming, Aan/Uit Actuator / Oppvarming; På/Av-aktuator /
Heizung; Ein/Aus Aktor / Topení; Zapnuto/Vypnuto aktor

Stop basic mode /
Stop basic mode /
Stopp Basic Mode /
Stoppe Basic Mode /
Ukončit základní režim

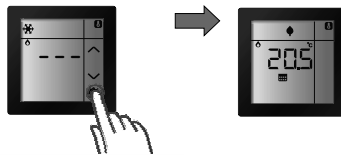

Timeout > 30 Sec.



Assign or remove device / Apparaat toewijzen of verwijderen / Tildele eller fjerne enheten / Zuweisen oder Entfernen von Geräten / Přiřazení nebo odebrání zařízení

1 Actor in Program mode

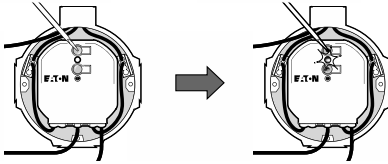

2 Select Device



Selected device is blinking / Geselecteerde apparaat knippert / Valgt enhet blinker / Ausgewähltes Gerätsymbol blinkt / Vybrané zařízení bliká

3 Assign or Remove

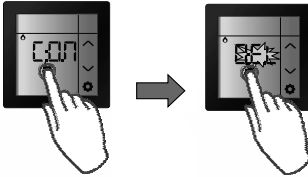

CON: Assign device / Apparaat toewijzen / Tildele enheten / Gerät zuweisen / Přiřazení zařízení
DEL: Remove device / Apparaat verwijderen / Fjerne enheten / Gerät entfernen / Odebrání zařízení

4 Confirm

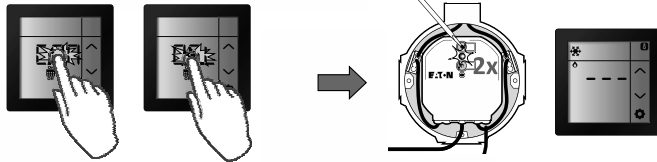

5 Stop Actuator Program mode



Back to factory default / Terug naar fabrieksinstellingen / Tilbake til fabrikkinstillingen / In Auslieferungszustand zurücksetzen / Obnovení továrního nastavení

1 Select



2a Confirm



2b Cancel







Quick User Guide / Quick User Guide / Hurtigveiledning / Schnellanleitung / Stručný návod k obsluze





Main menu

Hoofdmenu / Hovedmeny /
Hauptmenü / Hlavní menu



Active operation mode

-  Frost protection
-  Night / Standby
-  Economy
-  Day / Comfort



Select view

-  Temperature
-  Humidity
-  Clock
-  Outdoor temperature

Request status

-  Heating
-  Cooling
-  Ventilation

Status info

-  Week program active
-  Floor regulation active
-  Low battery

Optional

 2 virtual pushbutton





Temporaty adjust temperature





Operation mode - menu

Operation mode -menu / Driftsmodus - menyen /
Betriebsart - Menü / Provozní režim - nabídka



Select operation mode

-  Frost protection
-  Night / Standby
-  Economy
-  Day / Comfort

Select week program

-  Program ON
-  Program OFF

Select

-  Heating mode
-  Cooling mode
- Off

 Enter edit mode



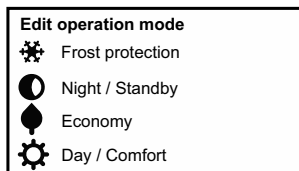

Edit mode - menu

Edit mode - menu / Redigeringsmodus - menyen /
Edit-Modus - Menü / Editační režim – nabídka

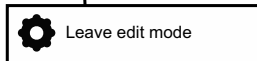
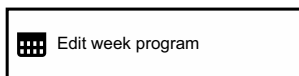

Change set-point



- EN: For the extended user guide and other detailed information about xComfort visit www.eaton.eu/xcomfort or www.xcomfort.com or use the QR-code
- DE: Für das erweiterte Benutzerhandbuch und detaillierte Informationen zum xComfort System besuchen Sie www.eaton.eu/xcomfort oder www.xcomfort.de oder verwenden Sie den QR-code
- AT: Für das erweiterte Benutzerhandbuch und detaillierte Informationen zum xComfort System besuchen Sie www.eaton.eu/xcomfort oder www.xcomfort.at oder verwenden Sie den QR-code
- NO: For en mer omfattende brukerveiledning og mer informasjon om xComfort, besøk www.xcomfort.no eller www.eaton.eu/xcomfort, eller bruk QR-koden
- NL: Voor de uitgebreide gebruikershandleiding en meer gedetailleerde informatie over xComfort ga naar www.eaton.nl/xcomfort of www.xcomfort.nl of maak gebruik van de QR-code
- CZ: Pro podrobnější návod k obsluze a další podrobné informace o xComfort návštěvte www.eaton.eu/xcomfort nebo www.xcomfort.cz nebo použijte QR kód





Declaration of Conformity

We, EATON Industries (Austria) GmbH
3943 Schrems, Eugenia 1
Austria

declare under our sole responsibility as the manufacturer that the product (family)

Eaton - Room Controller Touch, CRCA-00/xx (contains RF-Modul CSCZ-01/xx)

(the declaration of conformity applies to all listed types within our actual product catalogue)

provided that it is installed, maintained and used in the application intended for, with respect to the relevant manufacturers instructions, installation standards and "good engineering practices"

complies with the provisions of Council directive(s):

RED Directive 2014/53/EU

RoHS Directive 2011/65/EU

based on compliance with following standard(s):

EN 301489-3 V2.1.1, EN 300220-2 V3.1.1, EN 50491-5-1:2010, EN 50491-5-2:2010, EN 60950-1:2006 + A11:2009 + A1:2010 + A12:2011 + A2:2013, EN 62479:2010, EN 50581:2012



EU- type examination performed by:
TÜV Austria Services GmbH, Notified Body
1230 Vienna, Deutschstrasse 10, Austria

Fernando Ceccarelli

Senior Vice President
General Manager

02.08.2018

Friedrich Schröder

Director Quality
& Systems

Affixing date of CE mark: 2016

Doc.Id.: CRCA-00xx_020818

