

## Universal Motion Sensor CBMD-02/..

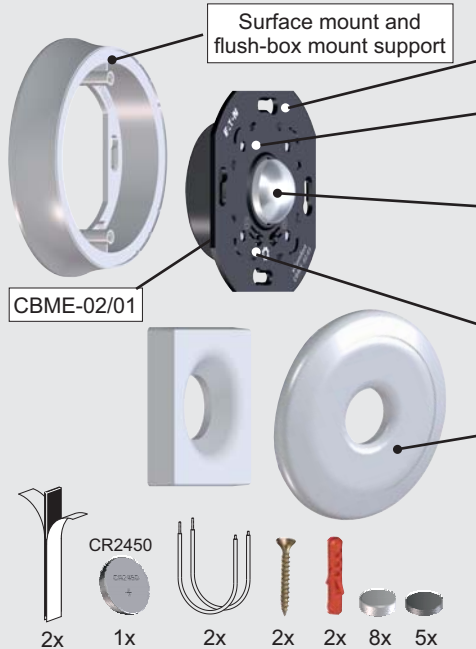

Battery or Mains powered

Battery 1x CR2450  
Long battery service life

Multi-Color Status LED

On-device detection settings

- Sensitivity
- Light (lux)
- Switch off delay
- Detection indication

Universal and 55 mm frame compatible cover included



**IP20**

868.3 MHz



Colors	Type Designation
Pure White	CBMD-02/01
Jet Black	CBMD-02/02

### Technical Data / Technische gegevens / Tekniske data / Technische Daten / Technická data

<b>Power supply</b>	
Mains	230 VAC +10% -15%, 50 Hz
Battery	CR2450 3Vdc
Battery Service Life	up to 5 years (TYP)
<b>Detection</b>	
Area (ceiling mount)	Depending on movement max. Ø 5 m when mounted at 2.5 m
Range (wall mount)	Depending on movement max. 8 m
Angle	90°
<b>On device settings</b>	
Sensitivity	low ... high
Light intensity	Night ... Day&Night (always)
Switch off delay	10 s ...120 min,
Detection indication	ON/OFF
LED	Multi-color operation status
Dimensions	ø 91 x 30 mm (D x H)
RF	868,3 MHz (xComfort copatible)
Max RF power	25 mW (ERP)



**MRF** Version V2.65

**RM** Version: V41c  
**SHC-RF** Version: 2.21  
**ECI-RF** Version: 2.10  
**USB-RF** Version: 2.10



www.eaton.com/xcomfort



**Positioning / Positionering / Posisjonering / Positionierung / Umístění**

Ceiling / Plafond / Tak / Decke / Strop

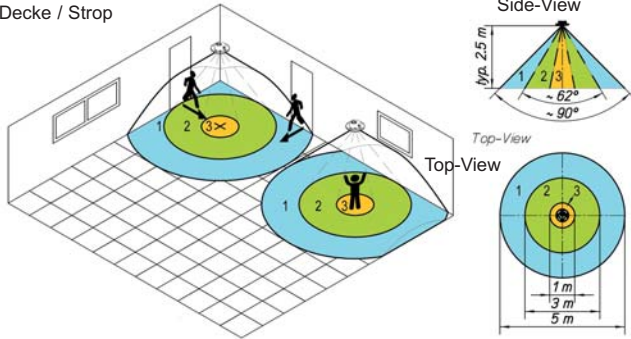

Wall / Wand / Vegg / Wand / Stěna

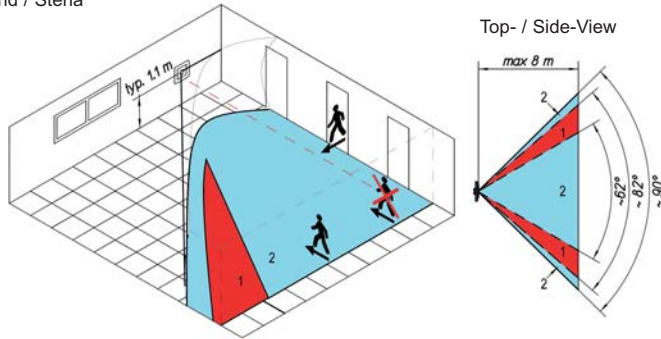

Corner / Hoek / Hjørne / Ecke / Roh

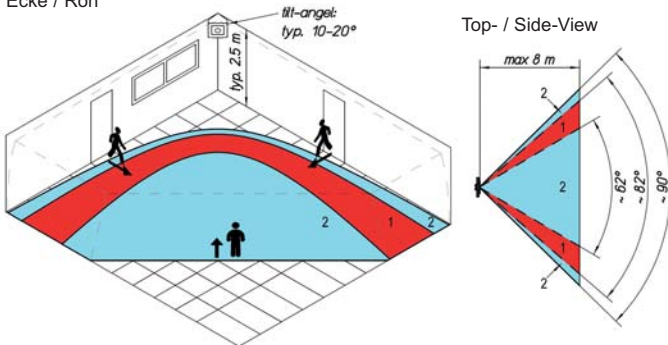

- Movements sideways relative to the sensor** / Bewegingen zijwaarts ten opzichte van de sensor / Bevegelser sidelengs i forhold til sensoren / Bewegungen seitlich zum Sensor / Pohyb příčně k senzoru
- Movements towards the sensor** / Bewegingen naar de sensor/ Bevegelser mot sensoren / Bewegungen zum Sensor / Pohyb podélně směrem k senzoru
- Small movements** / Kleine bewegingen / Lite bevegelser / Kleine Bewegungen / Malý pohyb
- Blind area - no detection** / Blind gebied - geen detectie / Blindsone / ingen deteksjon / Blindbereich - keine Erkennung / Slepá oblast - bez detekce

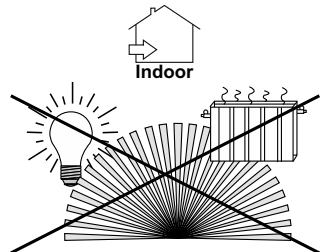



### 55x55mm Frame compatibility and mounting recommendation

Eaton	Merten	Gira	Busch&Jäger*	Jung	Berker	Siemens	Elko	Kopp
Standard	1-M	Standard 55	Carat	AS	S.1	Delta line	RS16	Alaska
	Atelier M	E2	Solo	A 500	B.1	Delta vita	Plus	
	M-Smart	Event	Future	A Plus	B.3	Delta miro		
	M-Arc	Esprit	Future Linear	A creation	B.7 Glas	Delta miro Glas		
	M-Star	E22	CZ Future					
	M-Plan		Busch-balance SI					
	M-Plan II							
	M-Plan Metall							

\* only with intermediate frame Busch&Jäger

**Compatible without extra magnets** / Compatibel zonder extra magneet / Compatibel uten ekstra magnet / Kompatibel ohne zusätzlichen Magneten / Kompatibilni bez dodatečného magnetu

**Compatible with extra magnet** / Compatibel met extra magneet / Kompatibel med ekstra magnet / Kompatibel mit zusätzlichem Magneten / Kompatibilni s dodatečným magnetem

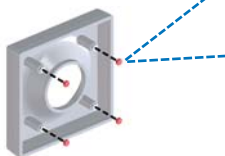

**Use extra magnets in case of reduced magnetic force (e.g. with non-flat walls)** /  
 Gebruik extra magneten in geval van verminderde magnetische kracht (bijv. Bij niet vlakke wanden) /  
 Bruk ekstra magneter i tilfelle redusert magnetisk kraft (f.eks. Med ujevne overflater) /  
 Bei geringerer Magnetkraft (z. B. bei nicht ebenen Wänden) zusätzliche Magnete verwenden /  
 V případě nerovných ploch, kdy je síla magnetů zeslabena použijte dodatečné magnety

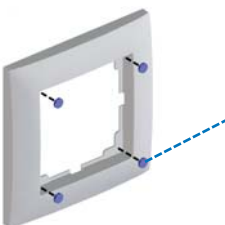

**If necessary, add foam pads to secure the frame** /  
 Voeg zonodig schuimkussentjes toe om het frame vast te zetten /  
 Legg eventuelt til skumputer for å feste rammen /  
 Fügen Sie bei Bedarf Schaumstoffpolster hinzu, um den Rahmen zu fixieren /  
 V případě potřeby instalujte pěnové podložky k zajištění rámečku



**Power supply / Stroomvoorziening / Strømforsyning / Spannungsversorgung / Napájení**

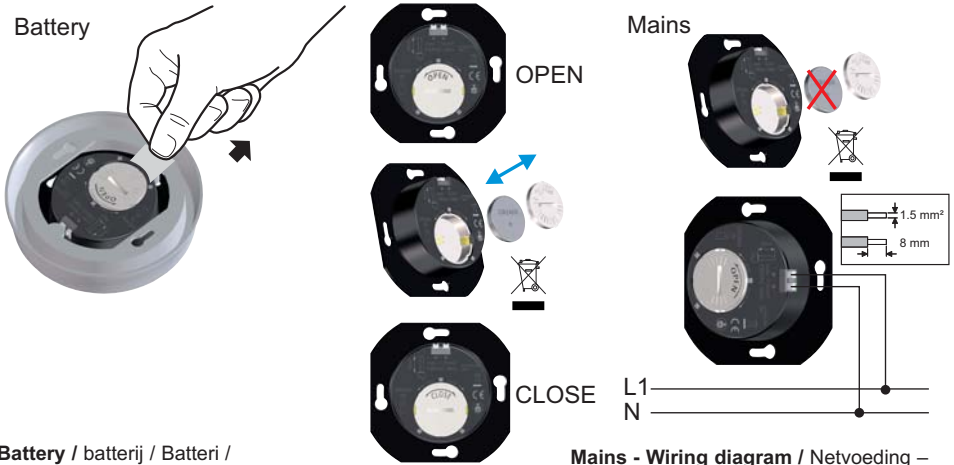

**Battery / batterij / Batteri / Batterie / baterie**

**Mains - Wiring diagram / Netvoeding – bedradingsschema / 230V – koblingskjema / Netzanschlussdiagramm / Napájení ze sítě**

**Basic Mode operations**

Assign Sensor in Basic Mode / Sensor in Basic Mode toewijzen / Tilknytte i Basic Mode / Zuweisen im Basic Mode / Konfigurace v základním režimu

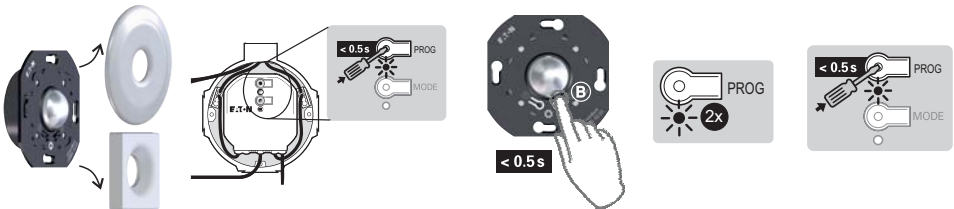

**Remove Sensor in Basic Mode / Sensor in Basic Mode verwijderen / Fjerne i Basic Mode / Löschen im Basic Mode / Zrušení přiřazení v základním režimu**

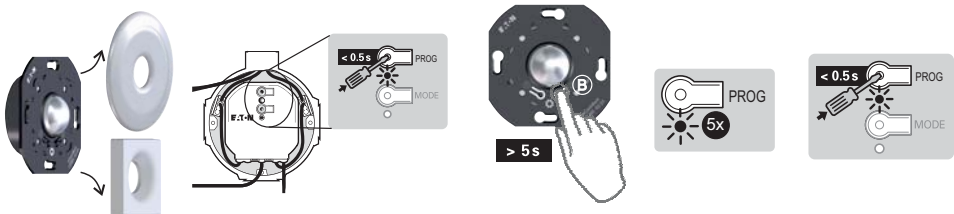

**Change detection settings / Wijzig detectie-instellingen / Endre innstillinger for detektering / Änderung der Bewegungsparameter / Změna nastavení senzoru**

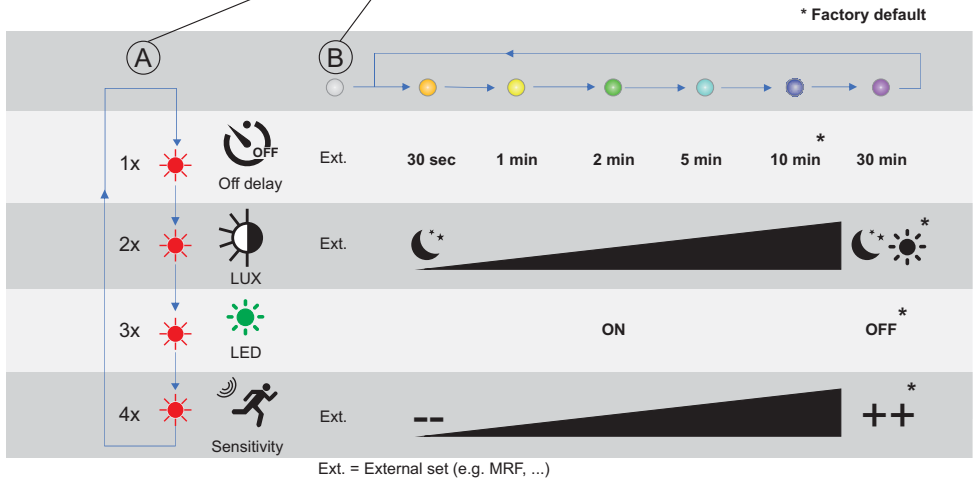
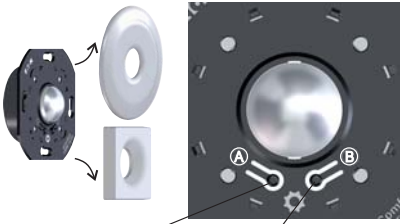

**LED during operation / LED tijdens bedrijf / LED under drift / LED im Normalbetrieb / LED během provozu**

**At status change / Bij statuswijziging / Ved statusændring / Bei Statusänderung / Při změně stavu**

- |   |   |
|---|---|
| <ul style="list-style-type: none"> <li><span style="color: blue;">●</span> <b>Short flash / No assignment</b><br/>Korte flits / Geen toekenning<br/>Kort blink / Ingen oppgave<br/>Kurzer Blitz / Keine Zuordnung<br/>Rychké blikání / Žádná přiřazení</li> <li><span style="color: red;">●</span> <b>Steady (5 s) / Replace battery</b><br/>Continue / Vervang de batterij<br/>Permanent / Bytt batteri<br/>Dauerlicht / Batterie wechseln<br/>Trvalé / Vyměnit baterii</li> </ul> | <ul style="list-style-type: none"> <li><span style="color: yellow;">●</span> <b>Short flash / Bad RF communication</b><br/>Korte flits / Slechte RF-communicatie<br/>Kort blink / Dårlig RF-kommunikasjon<br/>Kurzer Blitz / Schlechte RF-Kommunikation<br/>Rychké blikání / Špatná RF komunikace</li> <li><span style="color: red;">●</span> <b>Short flash / No RF communication</b><br/>Korte flits / Geen RF-communicatie<br/>Kort blink / Ingen RF-kommunikasjon<br/>Kurzer Blitz / Keine RF-Kommunikation<br/>Rychké blikání / Žádná RF komunikace</li> </ul> |
|---|---|

**At status change, when activated / Bij statusverandering, indien geactiveerd / Ved statusændring, når aktivert / Bei Statusänderung wenn aktiviert / Při změně stavu při aktivaci**

- **Short flash / RF communication okay**  
Korte flits / RF-communicatie in orde  
Kort blink / RF-kommunikasjon ok  
Kurzer Blitz / RF-Kommunikation in Ordnung  
Rychké blikání / RF komunikace je v pořádku



# Declaration of Conformity

We, EATON Industries (Austria) GmbH  
3943 Schrems, Eugenia 1  
Austria

declare under our sole responsibility as manufacturer that the product (family)

## Eaton - Motion Sensor, CBMD-02/xx

(the declaration of conformity applies to all listed types within our actual product catalogue)

provided that it is installed, maintained and used in the application intended for, with respect to the relevant manufacturers instructions, installation standards and "good engineering practices"

complies with the provisions of Council directive(s):

- RED Directive 2014/53/EU
- RoHS Directive 2011/65/EU

based on compliance with following standard(s):

- EN 300 220-2 V3.1.1, EN 300 220-2 V3.2.1, EN 301489-1 V1.9.2, EN 301489-1 V2.1.0, EN 301489-3 V1.6.1, EN 301489-3 V2.1.1, EN 606692-5:2017, IEC 63044-5-2:2017, IEC 63044-5-3:2017, EN 50581:2012



EU- type examination performed by:  
TUV Austria Services GmbH, Notified Body  
1230 Vienna, Deutschstrasse 10, Austria

Affixing date of CE mark: 2019  
Doc.Id.: CBMD-02xx\_011019

Fernando Ceccarelli

Senior Vice President  
General Manager

01.10.2019

Friedrich Schröder

Director Quality  
& Systems

