

Montageanweisung
 Assembly instructions
 Instructions de montage
 Montážní návod
 Montagevejledning
 Instrucciones de montaje
 Szerelési utasítás
 Istruzioni di montaggio
 Montasje anvisning
 Montage instructie
 Instruções de montagem
 Instrukcja montażu
 Montageanvisning
 Asennusohjeet
 Montaj talimatı
 Instrucțiuni de montaj

Инструкция по монтажу
 οδηγία συναρμολόγησης
 装配说明
 تعليمات التركيب







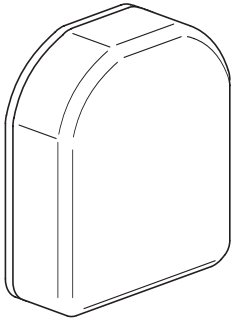

Lebensgefahr
 Danger
 Danger de mort
 Nebezpečí
 Fare
 Peligro
 Életveszély
 Pericolo di morte
 Fare
 Levensgevaar
 Perigo
 Niebezpieczeństwo
 Varning
 Vaara
 Hayati Tehlike
 Pericol
 Опасность
 κίνδυνος θανάτου
 危險
 خطر على الحياة







Montage nur durch Elektrofachkräfte
 Installation by electricians only
 Montage uniquement par un électricien
 Montáž pouze osobami s elektrotechnickou kvalifikací
 Må kun installeres af en aut. el-installatør
 Debe ser instalado por un profesional eléctrico
 Csak szakképzett személy szerelheti
 Montaggio esclusivamente ad opera di personale specializzato
 Må monteres av autorisert installatør Gr.L
 Montage alleen door elektromonteurs
 Deve ser instalado por um profissional
 Montaz tylko przez uprawnionych instalatorów
 Får endast utföras av behörig elektriker
 Asennus vain sähköasentajan toimesta
 Sadece uzman kişiler monte edebilir
 Instalare numai de către electricieni
 Монтаж может производить только электрик
 Εγκατάσταση μόνο από ηλεκτρολόγους
 仅允许电工安装
 التركيب فقط من قبل عمال كهرباء اختصاصيين

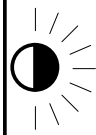

		Min. Version 1.09
		Min. Version 3.5

	T=-25°C - +70°C
	T=+5°C - +40°C

IP20

				
	M1	M2	M3	M4
	1x	2x	3x	4x

868,3 MHz

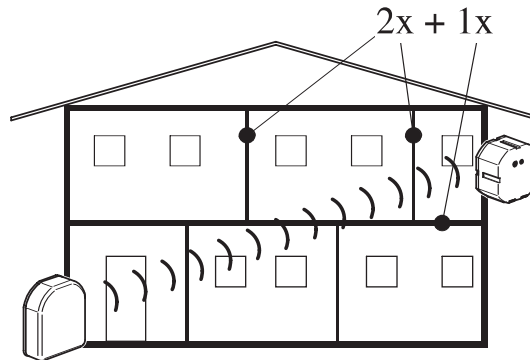
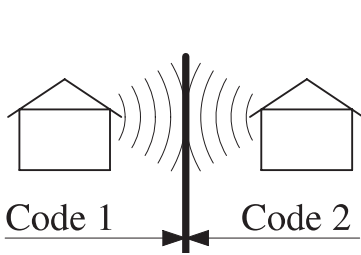
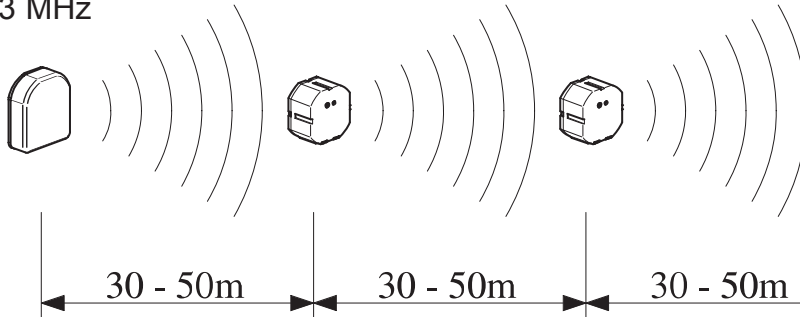

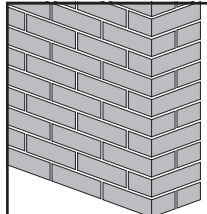
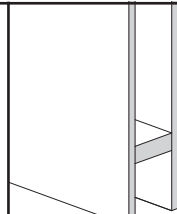
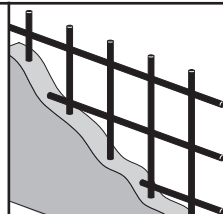
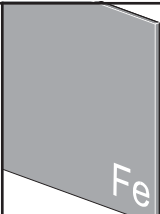
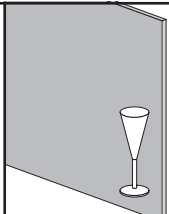
					
	ca. 60-90%	ca. 80-95%	ca. 20-60%	ca. 0-10%	ca. 70-90%

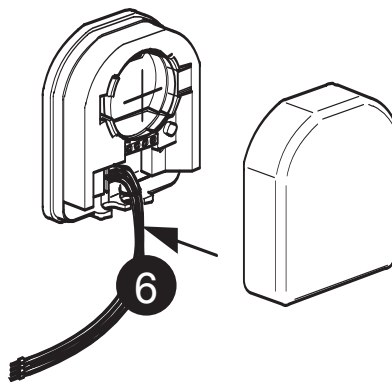
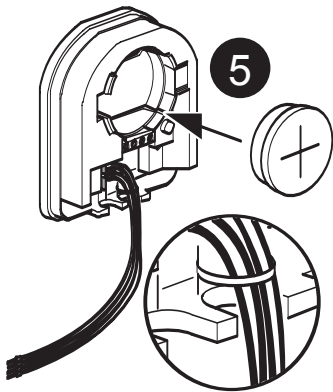
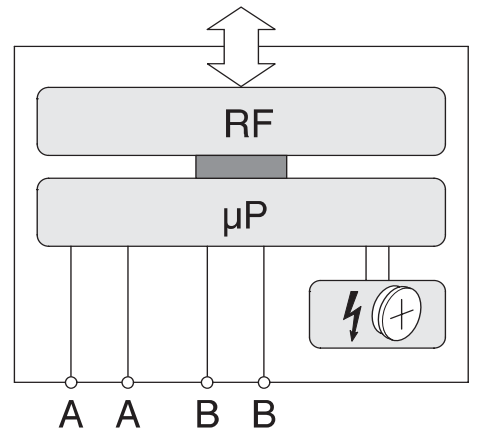
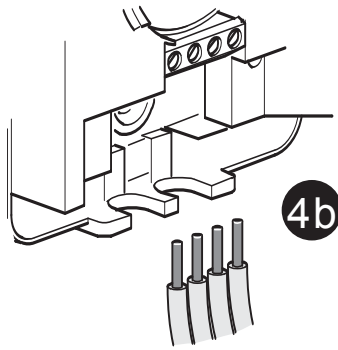
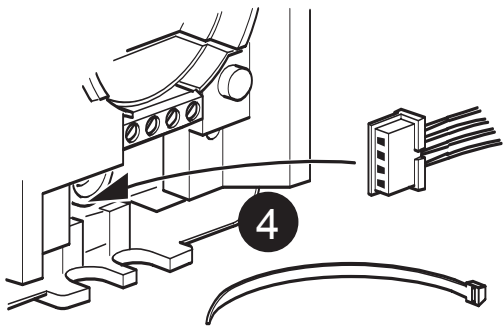
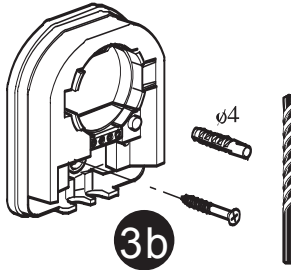
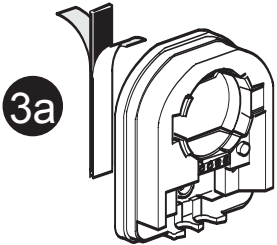
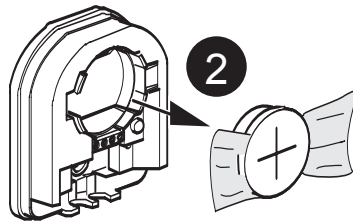
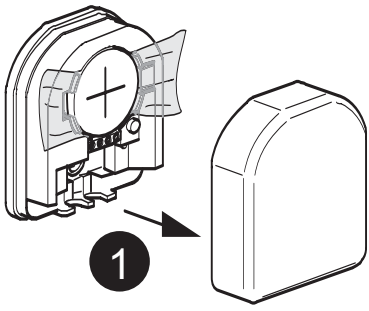

	1,5 mm ²
	5 mm

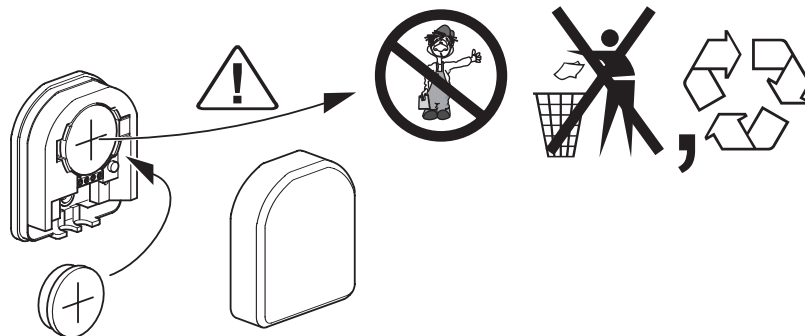

3V-CR2477N

Konformitätserklärung Declaration of Conformity

Wir **Moeller Gebäudeautomation KG**

We (Name des Anbieters / supplier's name)

**Eugenia 1
A-3943 Schrems**

(Anschrift / address)

bescheinigen hiermit, dass das Produkt

hereby certify that the product

Moeller – Binäreingang mit Batterieversorgung

Moeller – binary input with battery power supply

Type: **CBEU-02/02**

auf das sich diese Bescheinigung bezieht, mit der/den folgenden Norm(en) oder normativen Dokument(en) übereinstimmt.

to which this certification relates is in conformity with the following standard(s) or other normative document(s).

EN301489-3 V1.4.1, EN50090-2-2/96,

EN60950/00, EN300220-3 V1.1.1

(Titel und/oder Nr. sowie Ausgabedatum der Norm(en) oder der anderen normativen Dokumente /
Title and/or number and date of issue of the standard(s) or other normative document(s).)

Gemäß den Bestimmungen der Richtlinie(n)

Following the provisions of the Directive(s)

falls zutreffend / if applicable

Niederspannungsrichtlinie 73 / 23 / EWG

Low Voltage Directive 73 / 23 / EWG

EMV-Richtlinie 89 / 336 / EWG

EMC Directive 89 / 336 / EWG

Radio- und Telekommunikationsendgeräte 99 / 05 / EWG

Radio Equipment and Telecommunications Terminal Equipment 99 / 05 / EWG

Die Prüfung des Produkts wurde durchgeführt von:

Product examination was carried out by:

**TÜV Österreich, Notified Body 0408
Deutschstrasse 10
A-1230 Wien**

CE 0408 

**CTI-Vienna, Coorporative Testing Institute
Einzergasse 4
A-1210 Wien**

Eine rechtsverbindliche Konformitätserklärung gemäß EN 45014 liegt vor.
The legally declaration of conformity according EN 45014 is available.

Schrems, 24.10.03

(DI G. Idinger)

(Ing. F. Schröder)

(Ort und Datum der Ausstellung /
place and date of issue)

(Name und Unterschrift /
name and signature)

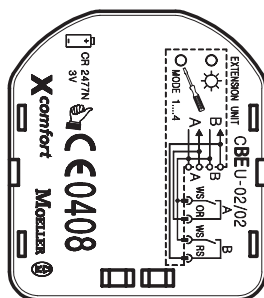

M1/M4

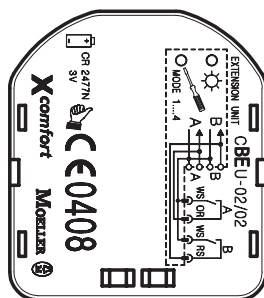

M2

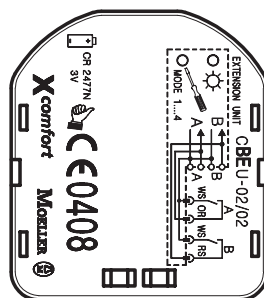

M3

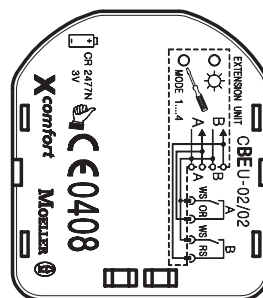

Windsensor Schnittstelle

Berker 0173

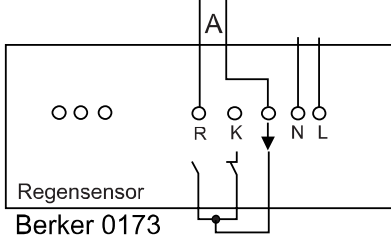
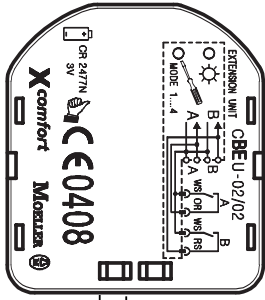





MOELLER



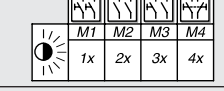

RF - SYSTEM

BASIC - MODE - CARD

www.moeller.at - info.aut@moeller.net

ma-rf-system.qxd/136211012

	CTAA-01/0X CTAA-02/0X
	CBEU-02/0X
	M1 M2 M3 M4 1x 2x 3x 4x
	CRCA-00/0X
	CHSZ-00/0X

	CSAU-01/0X CSAP-01/0X
	CJAU-01/0X
	CDAU-01/0X CDAP-01/0X
	0-10V OUT CAAE-01/0X

Correct Programming Sequence 1:

Correct Programming Sequence 2:

Correct Programming Sequence 3:

Correct Programming Sequence 4:

Correct Programming Sequence 5:

Incorrect Programming Sequence 1:

Incorrect Programming Sequence 2:

Incorrect Programming Sequence 3:

Incorrect Programming Sequence 4:

Incorrect Programming Sequence 5:

Incorrect Programming Sequence 6:

Incorrect Programming Sequence 7: