

Assembly instructions  
 Montageanweisung  
 Instructions de montage  
 Montážní návod  
 Montážni návod  
 Montagevejledning  
 Instrucciones de montaje  
 Szerelési utasítás  
 Istruzioni di montaggio  
 Montasje anvisning  
 Montage instructie  
 Instruções de montagem  
 Instrukcja montażu  
 Montageanvisning  
 Asennusohjeet  
 Montaj talimatı  
 Instrucțiuni de montaj  
 Инструкция по монтажу  
 οδηγία συναρμολόγησης  
 安装说明书  
 تعليمات التركيب



Danger  
 Lebensgefahr  
 Danger de mort  
 Nebezpečí  
 Nebezpečnostvo  
 Fare  
 Peligro  
 Életveszély  
 Pericolo di morte  
 Fare  
 Levensgevaar  
 Perigo  
 Niebezpieczeństwo  
 Varning  
 Vaara  
 Hayati Tehlike  
 Pericol  
 Опасность  
 κίνδυνος θανάτου  
 危險  
 خطر على الحياة



Installation by electricians only  
 Montage nur durch Elektrofachkräfte  
 Montage uniquement par un électricien  
 Montáž pouze osobami s elektrotechnickou kvalifikací  
 Montáž iba osobami s elektrotechnickou kvalifikáciou  
 Må kun installeres af en aut. el-installatør  
 Debe ser instalado por un profesional eléctrico  
 Csak szakképzett személy szerelheti  
 Montaggio esclusivamente ad opera di personale specializzato  
 Må monteres av autorisert installatør Gr.L  
 Montage alleen door elektromonteurs  
 Deve ser instalado por um profissional  
 Montaz tylko przez uprawnionych instalatorów  
 Får endast utföras av behörig elektriker  
 Asennus vain sähköasentajan toimesta  
 Sadece uzman kisiler monte edebilir  
 Instalare numai de catre electricieni  
 Монтаж может производить только электрик  
 Εγκατάσταση μόνο από ηλεκτρολόγους  
 仅允许合格电气技师进行安装  
 التركيب فقط من قبل عمال كهرباء اختصاصيين

CKOZ-00/14

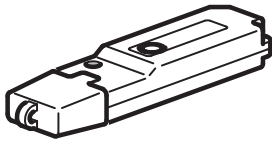

MRF  
**EAT•N** Min. Version 2.11



	T=-25°C - +70°C
	T=-5°C - +45°C

IP20

868,3 MHz

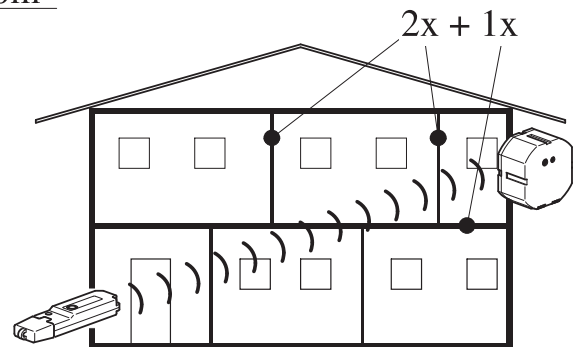
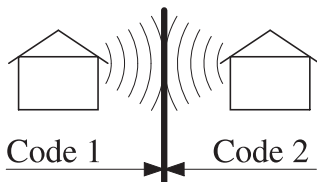
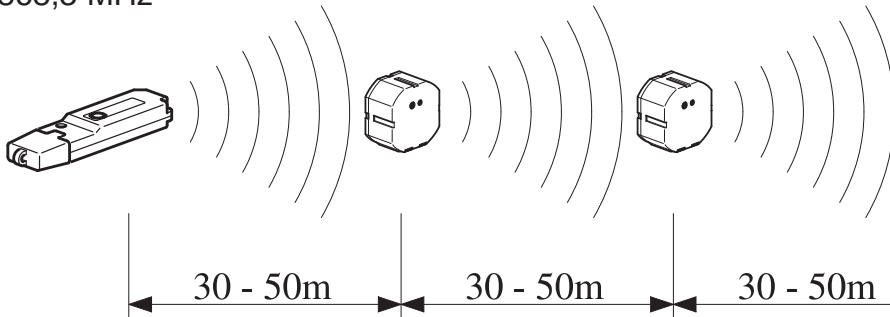

	~ 60-90%	~ 80-95%	~ 20-60%	~ 0-10%	~ 70-90%

1

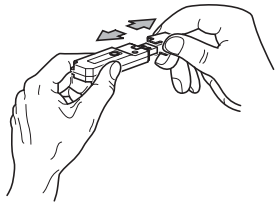

2

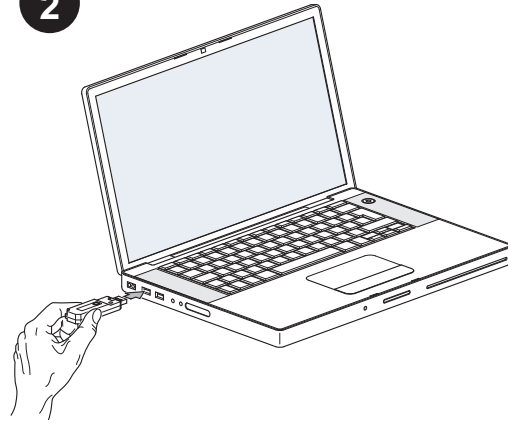

3

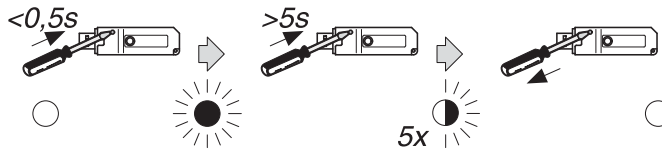
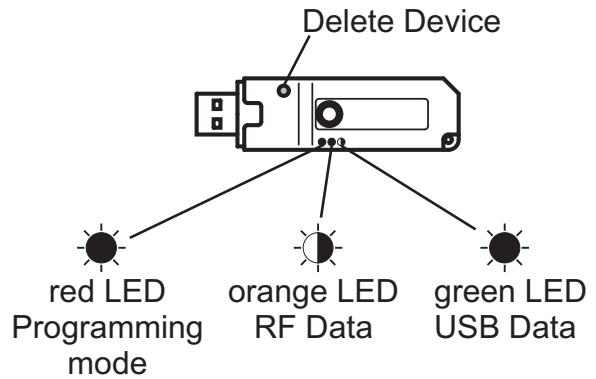

## Declaration of Conformity

We, EATON Industries (Austria) GmbH  
3943 Schrems, Eugenia 1  
Austria

declare that product (family)

**Eaton - Communication Stick,  
CKOZ-00/14**

(the declaration of conformity applies to all  
listed types within our actual product catalog)

provided that it is installed, maintained and used in the  
application intended for, with respect to the relevant manufacturers  
instructions, installation standards and "good engineering practices"

complies with the provisions of Council directive(s):

EMC Directive 2004/108/EC

Radio and Telecommunications Terminal Equipment 99/05/EC

based on compliance with European standard(s):

EN301489-3 V1.4.1, EN300220-2 V2.3.1, EN50491-5-1/10, EN50491-5-2/10,  
EN 62479/10, EN60950-1/06+A11/09+A11/10+A12/11



25.04.2012

H. Ursprunger F. Schröder

Affixing date of CE mark: 2012

Doc.Id.: CKOZ-00/14