

EU
xComfort CIZE-02/01

Assembly instructions
Montageanweisung
Instructions de montage
Montážní návod
Montážni návod
Montagevejledning
Instrucciones de montaje
Szerelési utasítás
Istruzioni di montaggio
Montasjeveiledning
Montage instructie
Instruções de montagem
Instrukcja montażu
Montageanvisning
Asennusohjeet
Montaj talimatı
Instruțiuni de montaj
Инструкция по монтажу
οδηγία συναρμολόγησης
安装说明书
تعليمات التركيب



Danger
Lebensgefahr
Danger de mort
Nebezpečí
Nebezpečenstvo
Fare
Peligro
Életveszély
Pericolo di morte
Fare
Levensgevaar
Perigo
Niebezpieczeństwo
Varning
Vaara
Hayati Tehlike
Pericol
Опасность
κίνδυνος θανάτου
危險
خطر على الحياة



Installation by electricians only
Montage nur durch Elektrofachkräfte
Montage uniquement par un électricien
Montáž pouze osobami s elektrotechnickou kvalifikací
Montáž iba osobami s elektrotechnickou kvalifikáciou
Må kun installeres af en aut. el-installatør
Debe ser instalado por un profesional eléctrico
Csak szakképzett személy szerelheti
Montaggio esclusivamente ad opera di personale specializzato
Må monteres av autorisert installatør
Montage alleen door elektromonteurs
Deve ser instalado por um profissional
Montaż tylko przez uprawnionych instalatorów
Får endast utföras av behörig elektriker
Asennus vain sähköasentajan toimesta
Sadece uzman kişiler monte edebilir
Instalare numai de către electricieni
Монтаж может производить только элекрик
Εγκατάσταση μόνο από ηλεκτρολόγους
仅允许合格电气技师进行安装
التركيب فقط من قبل عمال كهرباء الاختصاصيين

CIZE-02/01

CMMZ-00/12

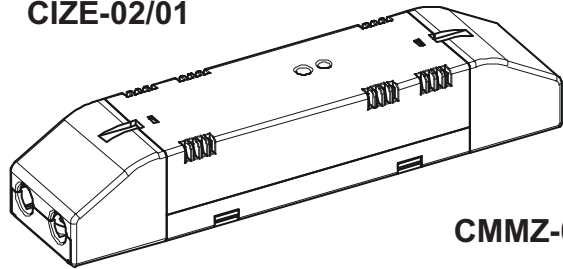

	Min. Version 1.46
	Min. Version 3.6B

CMMZ-00/13

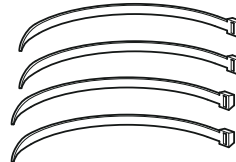

IP20

868,3 MHz

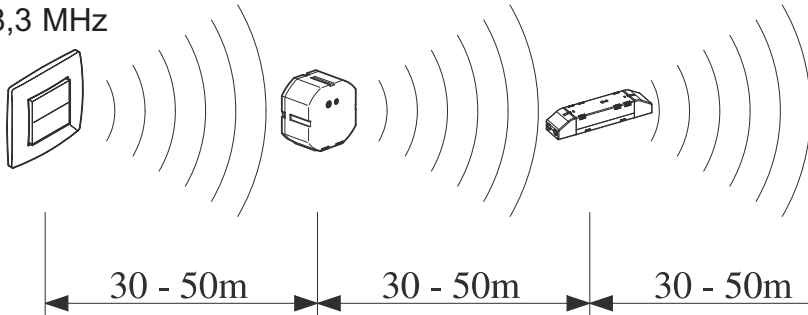

	T=-25°C - +70°C
	T=-5°C - +45°C

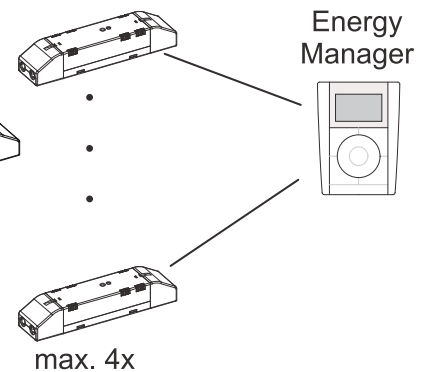
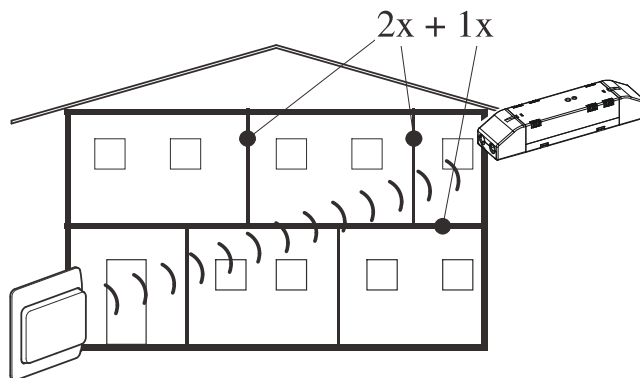
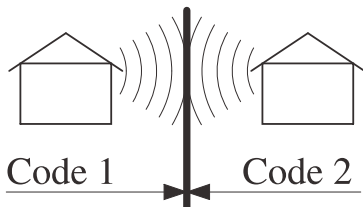

	~ 60-90%	~ 80-95%	~ 20-60%	~ 0-10%	~ 70-90%

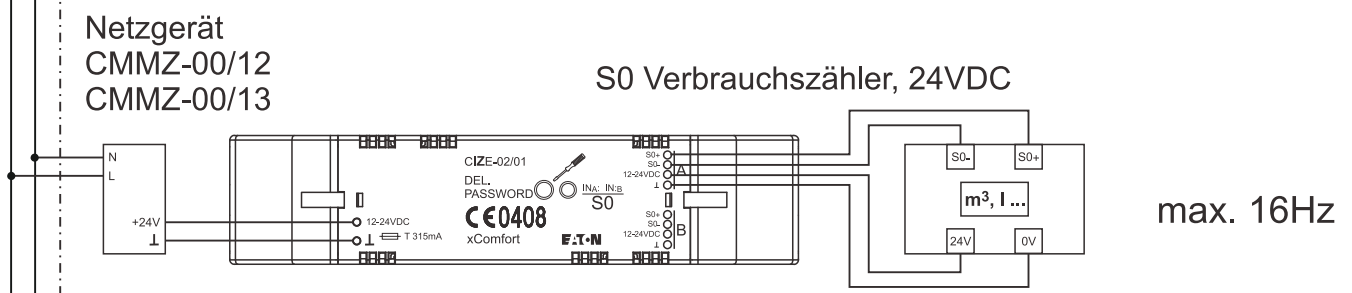
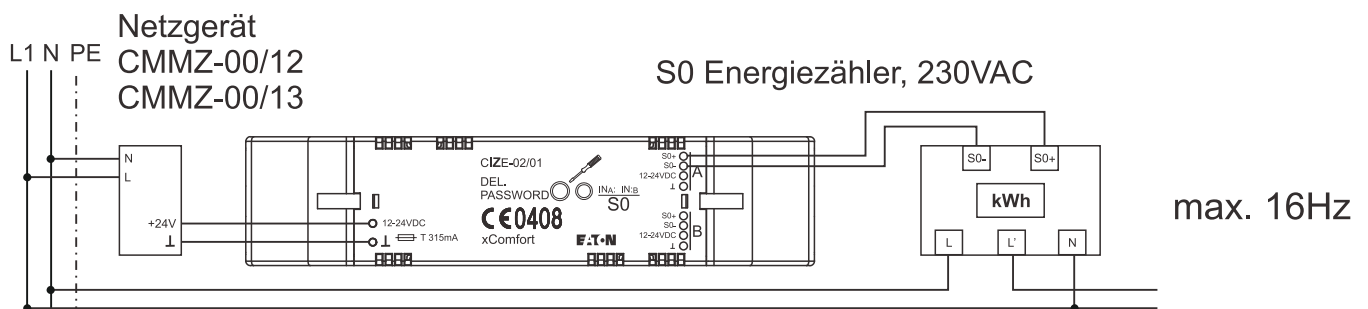
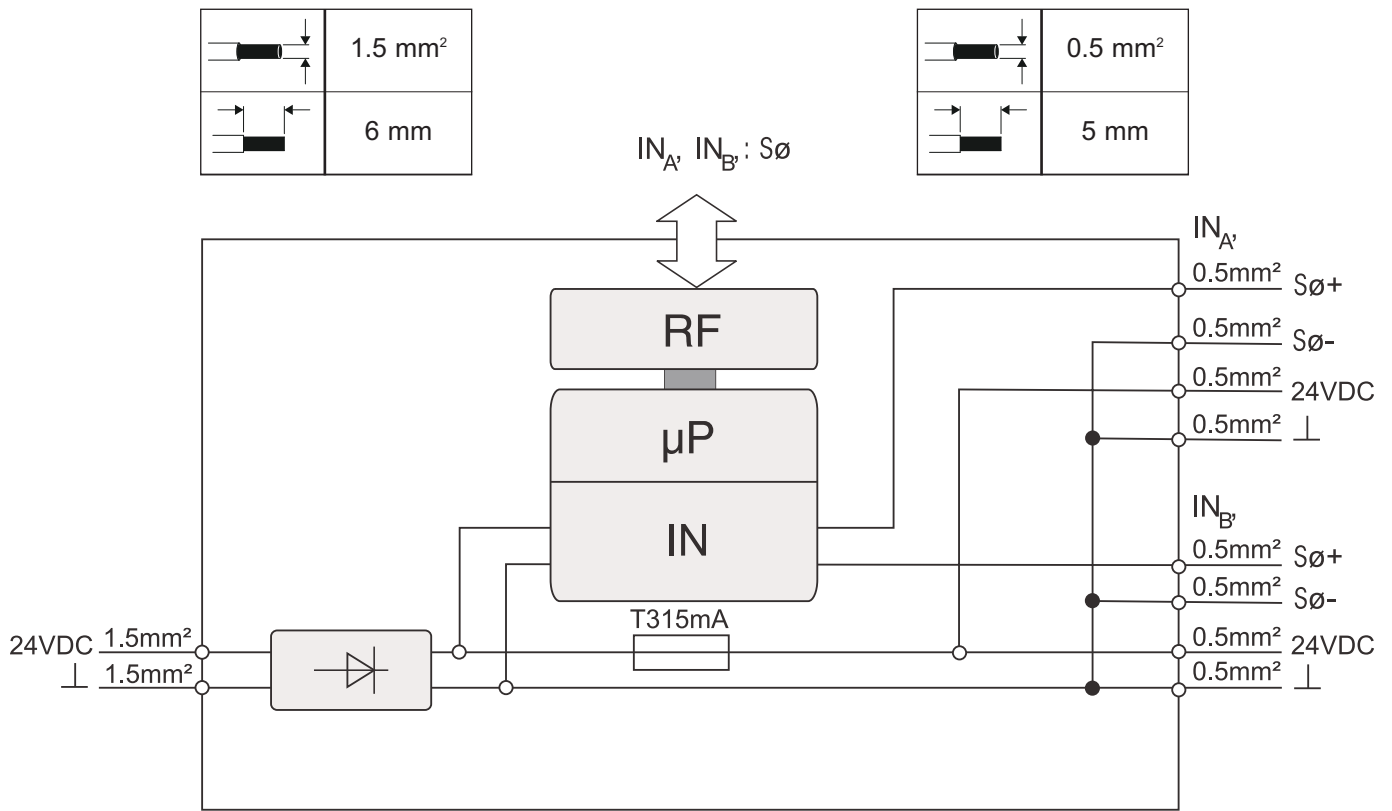



Declaration of Conformity

We, EATON Industries (Austria) GmbH
3943 Schrems, Eugenia 1
Austria

declare under our sole responsibility that the product (family)

Eaton - Impulse Counter Input 2-fold, CIZE-...

(the declaration of conformity applies to all listed types within our actual product catalogue)

provided that it is installed, maintained and used in the application intended for, with respect to the relevant manufacturers instructions, installation standards and "good engineering practices"

complies with the provisions of Council directive(s):

RED Directive 2014/53/EU

RoHS Directive 2011/65/EU

based on compliance with following standard(s):

EN 301489-3 V2.1.1, EN 300220-2 V3.1.1, EN 50491-5-1:2010, EN 50491-5-2:2010, EN 60950-1:2006 + A11:2009 + A1:2010 + A12:2011 + A2:2013, EN 62479:2010, EN 50581:2012

17.11.2017

Fernando Ceccarelli

Friedrich Schröder

EU- type examination performed by:
TÜV Austria Services GmbH, Notified Body
1230 Vienna, Deutschstrasse 10, Austria

Senior Vice President
General Manager

Director Quality
& Systems

Affixing date of CE mark: 2008
Doc.Id.: CIZE-..._171117

RF- SYSTEM

BASIC - MODE - CARD

RF- SYSTEM

BASIC - MODE - CARD

CTAA-01/01
CTAA-02/01

CBEU-02/01
CBEU-02/02

M1 M2 M3 M4
1x 2x 3x 4x

CRCA-00/01

CHSZ-00/01

CSAU-01/01

CJAU-01/01

CDAU-01/01

