



Hydraulics

Heavy-Duty Series 2
Hydrostatic Piston Pumps
Parts and Service

Model 3322
Model 3922
Model 4622

Model 5422
Model 6422

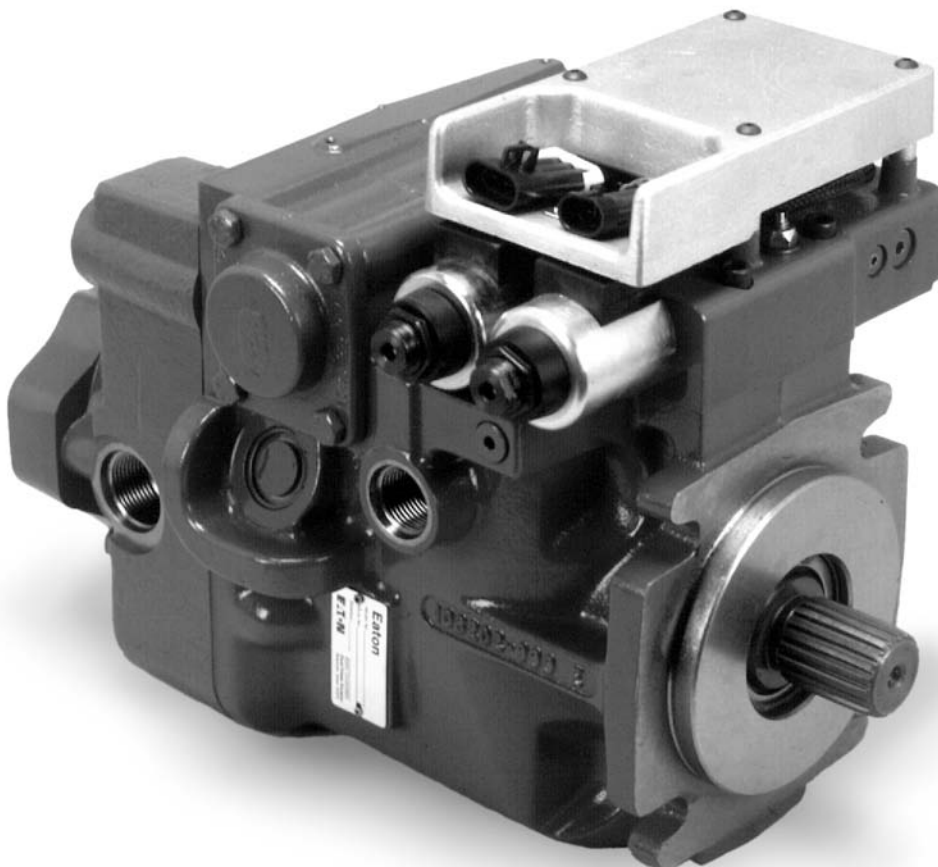

Table of Contents

Introduction	3
IDTag Information	3
Parts Drawings	
Required Tools for Disassembly/Reassembly	4
Disassembly Order	4
Exploded Views	
Charge Pump and End Cover Assembly	5
Rotating Group and Main Housing	6
Parts Lists	
Models 3322/3922/4622 (54, 64, 75 cc/rev)	7
Models 5422/6422 (89, 105 cc/rev)	8
Main Housing	9
Drive Shaft Subassembly	9
End Cover	10-11
Controls	
Manual Control Valve	12
Manual Control Valve Wide Band	12
Manual Control Valve with N/C Neutral Lockout	12
Solenoid Control Kit	13
Hydraulic Remote Control Kit	14
Connector Kits	14
Electronic Proportional (EP) Displacement Control	15-16
Rotating Group/Swashplate Subassembly	17-18
Hold-down Kits	19
Propel Valve Plate or V-Groove Plate	19
Charge Pump Subassembly	20
Auxiliary Mounting Kits	20-22
Servo Piston and Cover	23
Pressure Override Valve	24
High Pressure Valve	24
Low Pressure Relief Valve	25
Kits	26
Repair Information	
Disassembly	27-33
Assembly	34-43
Troubleshooting	44-53
Valve /Test Port Location	45
Gauge Requirements, Gauge Port Size and Location	46
Pressure Readings	46
Nominal Operating Pressures	46
Fault-Logic Tables	47-51
Tips	52
Hydraulic Fluid Recommendations	53-54
Special Tools	55-57
Model Code Description	58-59

Introduction

This Manual provides parts and service information for Eaton® Heavy Series 2 Hydrostatic Piston Pumps, Models 3322, 3922, 4622, 5422 and 6422. Step by step instructions for complete disassembly, inspection and reassembly of the pump are given.

The following recommendations should be followed to insure successful repairs.

- Most repairs require the removal of the pump from the vehicle.
- Cleanliness is extremely important.
- Clean the port areas thoroughly before disconnecting the hydraulic lines.
- Plug the pump ports and cover open hydraulic lines immediately after they have been disconnected.
- Drain the oil and clean the exterior of the pump before making repairs.
- Wash all metal parts in clean solvent.
- Use filtered, moisture-free compressed air to dry the parts. Do not wipe them dry with paper towels or cloth – lint in a hydraulic system will cause damage.
- Always use new seals when reassembling hydraulic pumps.
- Lubricate new rubber seals with a petroleum jelly (Vaseline®) before installation.
- Torque all bolts over gasketed joints, then repeat the torquing sequence to make up for gasket compression.

After all repairs are complete it is essential to verify the accuracy of pump repairs on an authorized test stand.

ID Tag

Refer to specific part listings for your Eaton pump when ordering replacement parts. Listings are available from Eaton. Sample tag shows identification.

When ordering replacement parts, you must include the following information:

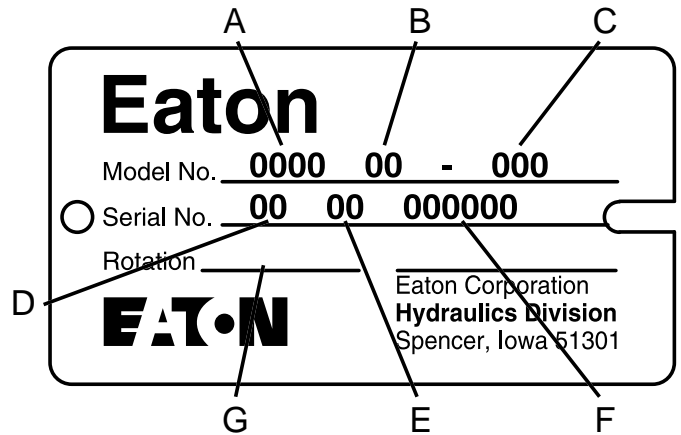

A Displacement
cu.in/rev.(cc/rev.)
0033 = 3.3(54)
0039 = 3.9(64)
0046 = 4.6(75)
0054 = 5.4(89)
0064 = 6.4(105)

B Identifies Type of Product
22 = Variable Displacement Pump
C Identifies Specific Unit Configuration
D Month of Manufacture

E Year of Manufacture
F Specific Serial Number of Unit
G Direction of Input Shaft Rotation Observed from Shaft End of Unit
CW=Clockwise
CCW=Counterclockwise

Required Tools

Disassembly/ Assembly

- 1/4 in. Hex Key
- 5/16 in. Hex Key
- 9/16 in. Hex Key
- 5/8 in. Hex Key
- 12 mm Hex Key
- 5/16 in. Socket or End Wrench
- 1/2 in. Socket or End Wrench
- 9/16 in. Socket or End Wrench
- 11/16 in. End Wrench
- 3/4 in. Socket or End Wrench
- 1 in. Socket or End Wrench
- 1-1/4 in. Socket or End Wrench
- Breaker Bar or Ratchet Wrench
- Torque Wrench (200 Max. Capacity)
- Adjustable Pliers
- Screwdrivers (Small & Large)
- Internal Retaining Pliers (str. .047 Tips)
- Internal Retainer Pliers (Str. Tips)
- Dial Indicator with Magnetic Base
- Depth Micrometer with Extensions
- Parallel Bars (2)
- Slide Hammer

- Split Blade Bearing Puller
- Hammer (Steel and Plastic)
- Small Machinist Ruler
- Small Flashlight
- Light Petroleum Jelly
- Suitable Solvents and Cleaners

Special Tools (shown on pages 54-56)

- End Cover Tool
- Limit Stop for Bearing Cone Installation
- Low Clearance Bearing Puller
- Seal Bullet

Disassembly Order for Main Components

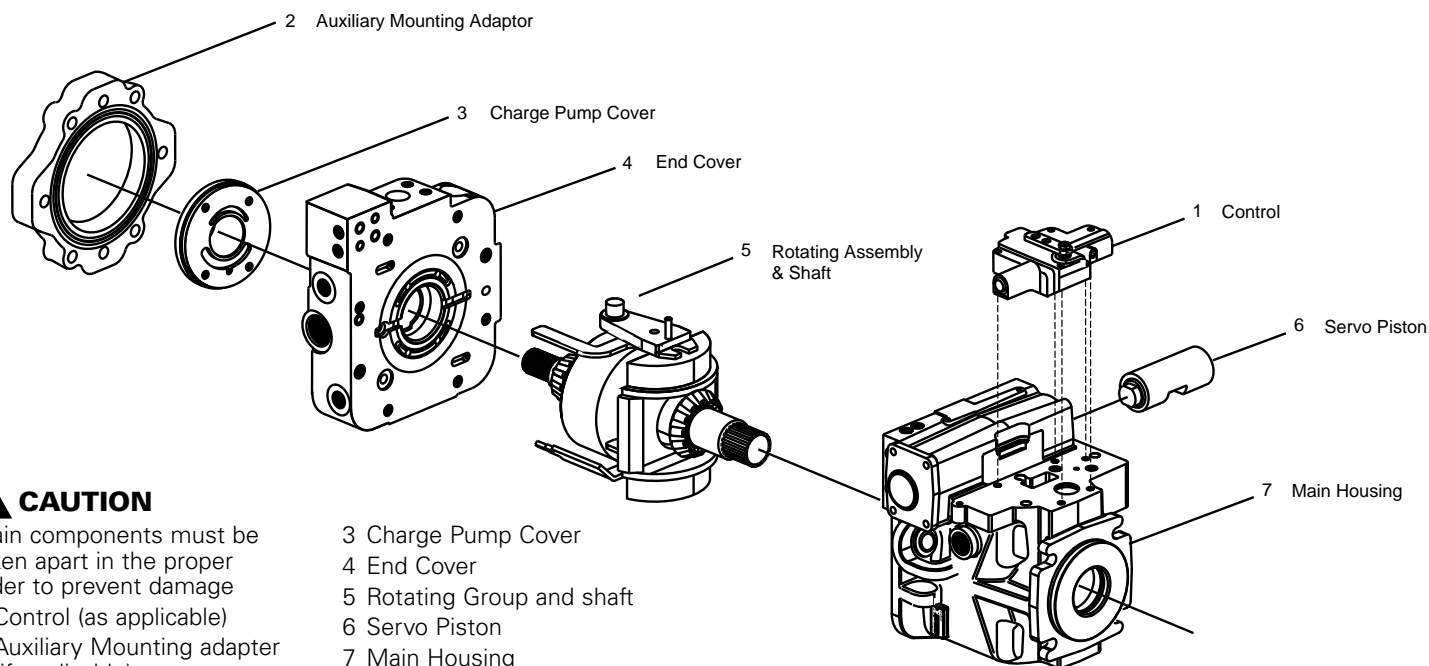

Parts Drawing

Charge Pump & End Cover Assembly

DISPLACEMENT

Model 3322	54,4 cm ³ /rev	3.32 in ³ /rev
Model 3922	63,7 cm ³ /rev	3.89 in ³ /rev
Model 4622	75,4 cm ³ /rev	4.59 in ³ /rev
Model 5422	89,2 cm ³ /rev	5.44 in ³ /rev
Model 6422	105,5 cm ³ /rev	6.44 in ³ /rev

***Note:** This is a typical Series 2 configuration. Your model may differ slightly from this view depending on features installed.

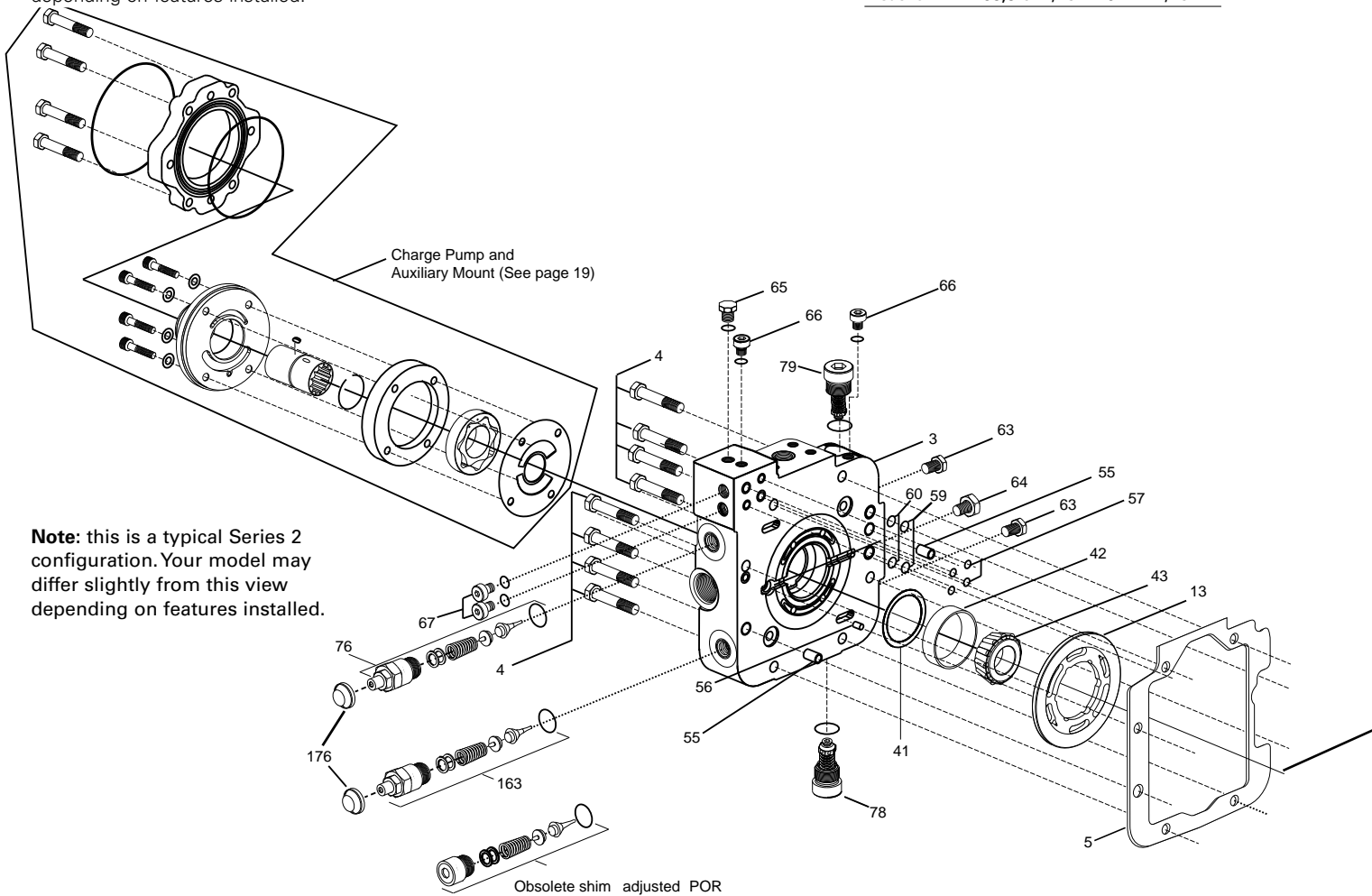

Same Side Ported End Cover

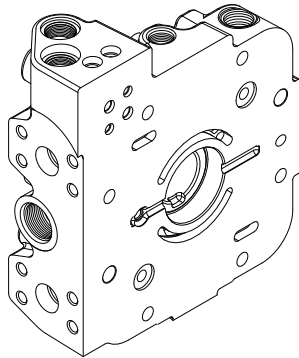

Model 5422-6422

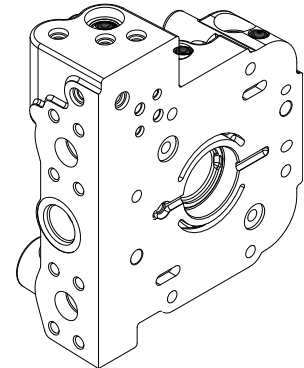

Model 3322-4622

Parts Drawing

Rotating Group & Main Housing Assembly

***Note:** This is a typical Series 2 configuration. Your model may differ slightly from this view depending on features installed.

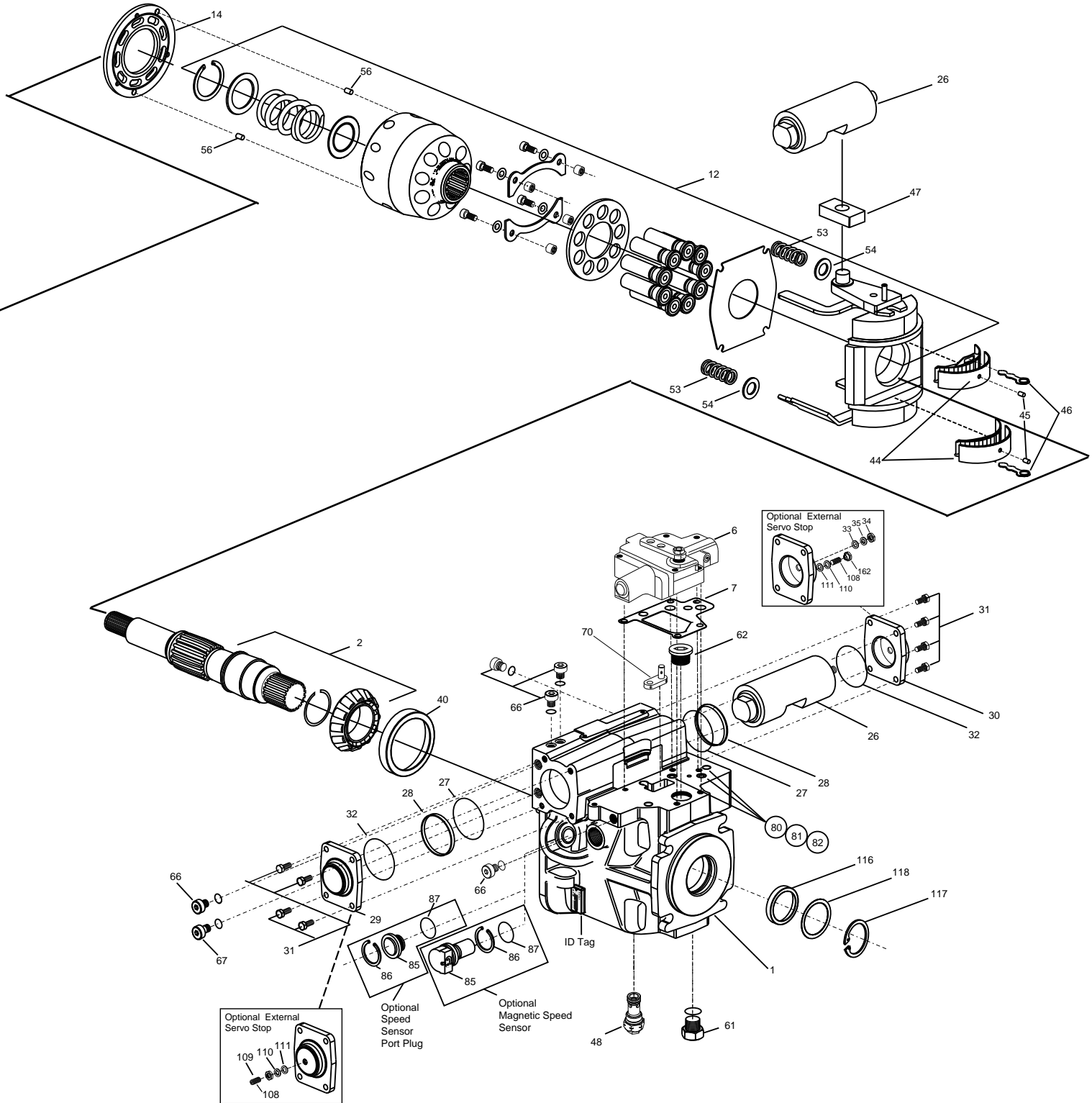

Parts List

Models 3322/3922/4622

ITEM	P/N	QTY.	DESCRIPTION	REFERENCE PAGES
1	See Table 2.0	1	Main Housing	9
2	See Table 3.0	1	Drive Shaft Sub-assembly	9
3	See Table 4.0, 4.1	1	End Cover	10-11
4	103090-325	8	Hex Bolt HD 3/8-16 Gr. 8	
5	See Table 18.0	1	End Cover Gasket	25
6,7,8,9	See Table 5.0-6.1	1	Control Valve	12-16
12	See Table 7.0-7.1	1	Rotating Kit Sub-assembly	17-18
13	See Table 9.0	1	Propel Valve/V-Groove /Quiet Plate	19
14	1032411		Bearing Plate (Models 33/39)	
14	1041981		Bearing Plate (Model 46)	
15,16,17,18,19,20,21,22,23,24	See Table 10.0,10.1		Charge Pump Subassembly	20-22
28	108300*	2	Ring Seal	
26	See Table 11.0, 11.1	1	Servo Piston Sub-assembly	23
27	8761-144*	2	O-Ring	
28	108300*	2	Ring Seal	
29	See Table 11.1		Servo Piston Cover	23
30	See Table 11.1		Servo Piston Cover	23
31	95862-088	8	Hex Bolt HD 5/16-18 Gr 5	
32	8761-139*	2	O-Ring	
33	16254-8	1	Thread seal	
34	96097-050	1	Nut, Hex .50-20	
35	16254-28	1	Washer	
40	103232-000	1	Bearing Cup	
41	See Table 15.0	A/R	End Cover Bearing Shim Kit	26
42/43	108295-000	1	Bearing Cup/Bearing Cone Subassembly	
44	107575	2	Swash Bearing Sub-assembly	
45	108331	2	Race Pin	
46	108823	2	Clocking Link	
47	108152	1	Slide Block	
48	See Table 14.0**	1	Low Pressure Relief Valve Plug	25
49	8785-012*	1	O-Ring	
53	108214	2	Hold Down Spring	
54	16048-480	2	Hold Down Washer	
55	107582	2	Hollow Dowel	
56	98202	3	Dowel	
57	110457-000*	4	Static Face Seal	
59	8761-017*	2	O-Ring (between end cover and housing)	
60	108562-000*	2	Back-up Ring (between end cover and housing)	
61	25083-01	1	O-Ring Plug	
62	107887	1	O-Ring Plug Soc HD	
63	25706-006	2	O-Ring Plug	
64	25090-010	1	O-Ring Plug	
65	25090-004	3	O-Ring Plug	
66	25083-004	12	O-Ring Plug (not all positions shown)	
67	25083-002	3	O-Ring Plug (used with Pressure Override option)	
68	96559	1	Shipping Strap (not shown)	
70	111402-000	1	Control Link Sub-assembly	
71, 72	See Table 5.0		Manual Control	12
76	4994730-xxx ⁽¹⁾ See Table 12.0	2	Relief Valve, Pressure Override (optional)	23
78	110700-xxx ⁽¹⁾ See Table 13.0,13.1	1	Relief Valve and/or Check Valve (B Port)	23

ITEM	P/N	QTY.	DESCRIPTION	REFERENCE PAGES
79	110700-XXXXXX ⁽¹⁾ See Table 13.0, 13.1	1	Relief Valve and/or Check Valve (A Port)	24
80,81,82	See Table 1.0	1	Control Valve Orifice	8
83	95653-012	2	Soc Pipe Plug .125-27 NPTF (inside charge pump inlet port)	
84	95653-006	2	Soc Pipe Plug .062-27 NPTF (inside charge pump inlet port)	
85	**	1	Magnetic Speed Sensor (optional)	
	108307	1	Plug (optional)	
86	16160-125	1	Retaining Ring (optional)	
87	8761-016*	1	O-Ring	
95, 96, 97, 105			See Charge Pump Sub-assembly	20-22
116	**	1	Drive Shaft Seal	
117	**	1	Ring, Retaining	
118	**	1	Spacer	
119	95653-012	1	Soc Pipe Plug .125-27 NPTF (optional)	
163	4994730-XXX See Table 12.0	1	Pressure Override Relief Valve (optional)	24
176	499161-001	2	Cap Nut	

*available in gasket kit 990710-000

**available in kit

(1)See Table 14.1 for correct part number identification and pressure settings.

Used only with remote or pressure side filtration.

Parts List

Models 5422/6422

ITEM	P/N	QTY.	DESCRIPTION	REFERENCE PAGES
1	See Table 2.0	1	Main Housing	9
2	See Table 3.0	1	Drive Shaft Subassembly	9
3	See Table 4.0, 4.1	1	End Cover	10-11
4	103091-325	8	Hex Bolt HD 7/16-16 Gr8	
5	See Table 18.0	1	End Cover Gasket	26
6,7,8,9	See Tables 5.0-6.11		Control Valve	14
12	See Table 7.0	1	Rotating Kit Subassembly	16
13	See Table 8.0	1	Propel Valve/V-Groove /Quiet Plate	18
14	103852	1	Bearing Plate (Model 54)	
14	103814	1	Bearing Plate (Model 64)	
15,16,17,18,19,20,21,22,23,24	See Table 10.0-10.1		Charge Pump Subassembly	19-21
28	108300*	2	Ring Seal	
26	See Table 11.0	1	Servo Piston Sub-assembly	22
27	8761-157*	2	O-Ring	
28	108915*	2	Ring Seal	
29, 30	See Table 11.1		Servo Piston Cover	22
31	95912-088	8	Screw, Cap Soc HD 5/16-18 Gr 8	
32	8761-145*	2	O-Ring	
33	16254-8	1	Thread seal	
34	96097-050	1	Nut, Hex .50-20	
35	16254-28	1	Washer	
40	103807-000	1	Bearing Cup	
41	See Table 15.0	A/R	End Cover Bearing Shim Kit	25
42/43	990386-000	1	Bearing Cup/Bearing Cone Subassembly	
44	111892	2	Swash Bearing Subassembly	
45	108331	2	Race Pin	
46	108973	2	Clocking Link	
47	108349	1	Slide Block	
48	See Table 14.0**	1	Low Pressure Relief Valve	24
49	8785-012*	1	O-Ring	
53	108214	2	Hold Down Spring	
54	16048-480	2	Hold Down Washer	
55	108369	2	Hollow Dowel	
56	98202	3	Dowel	
57	110457-000*	4	Static Face Seal	
59	8761-017*	2	O-Ring (between end cover and housing)	
60	108562-000*	2	Back-up Ring (between end cover and housing)	
61	25083-01	1	O-Ring Plug	
62	107887	1	O-Ring Plug Soc HD	
63	25706-006	2	O-Ring Plug	
64	25090-010	1	O-Ring Plug	
65	25090-004	3	O-Ring Plug	
66	25083-004	12	O-Ring Plug (not all positions shown)	
67	25083-002	3	O-Ring Plug (used with Pressure Override option)	
69	101822	1	Shipping Strap (not shown)	
70	111402-000	1	Control Link Sub-assembly	
71, 72	See Table 5.0		Manual Control	12
76	4994730-xxx ⁽¹⁾ See Table 12.0	2	Relief Valve, Pressure Override (optional)	23
78	110700-xxx ⁽¹⁾ See Table 13.0,13.1	1	Relief Valve and/or Check Valve (B Port)	23

ITEM	P/N	QTY.	DESCRIPTION	REFERENCE PAGES
79	110700-XXXXXX ⁽¹⁾ See Table 13.0, 13.1	1	Relief Valve and/or Check Valve (A Port)	23
80,81,82	101619-xxx		See Table 1.0 Control Valve Orifice See Below	
83	95653-012	2	Soc Pipe Plug .125-27 NPTF (inside charge pump inlet port)	
84	95653-006	2	Soc Pipe Plug .062-27 NPTF (inside charge pump inlet port)	
85	See Table 17	1	Magnetic Speed Sensor (optional)	25
	108307	1	Plug (optional)	
86	16160-125	1	Retaining Ring (optional)	
87	8761-016*	1	O-Ring	
95, 96, 97, 105			See Charge Pump Sub-assembly	19-21
116	See Table 16.0	1	Drive Shaft Seal	26
117	See Table 16.0	1	Ring, Retaining	26
118	See Table 16.0	1	Spacer	26
119	95653-012	1	Soc Pipe Plug .125-27 NPTF (optional - used only with remote or pressure side filtration)	
163	4994730-XXX See Table 14.0	1	Pressure Override Relief Valve (optional)	24
176	499161-001	2	Cap Nut	

*available in gasket kit 990710-000

**available in kit

(1)See Table 14.1 for correct part number identification and pressure settings.

Table 1.0

Control Valve Orifice (Item 80, 81, 82)

ITEM	PART NO.	SIZE mm[inch]	DESCRIPTION
80, 81,82	101619-021	5,3[.021]	Control Valve Orifice
80, 81,82	101619-028	7,1[.028]	Control Valve Orifice
80, 81,82	101619-036	9,1[.036]	Control Valve Supply Orifice
80, 81,82	101619-044	11,1[.044]	Control Valve Orifice
80, 81,82	101619-048	12,1[.048]	Control Valve Orifice
80, 81,82	101619-052	13,2[.052]	Control Valve Orifice
80, 81,82	101619-057	14,5[.057]	Control Valve Orifice
80, 81,82	101619-065	16,5[.065]	Control Valve Orifice
80, 81,82	101619-073	18,5[.073]	Control Valve Orifice
80, 81,82	101619-081	20,6[.081]	Control Valve Orifice
80, 81,82	101619-094	23,9[.094]	Control Valve Orifice
80, 81,82	101619-102	25,9[.102]	Control Valve Orifice

Parts List

Main Housing

(Item 1)

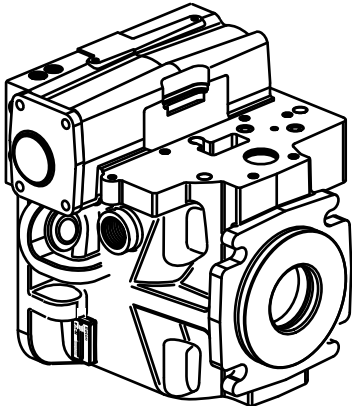

Drive Shaft Subassembly

(Item 2)

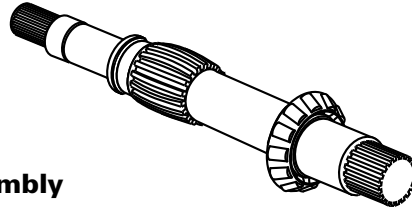

*Note: Bearing cup must be replaced with shaft and new bearing cone

Table 2.0 Main Housing

Models 3322/3922/4622

PART NO.	QTY.	DESCRIPTION
111813-000	1	Main Housing
111811-000	1	Main Housing, Pressure Override
111812-000	1	Main Housing, Speed Sensor
111810-000	1	Main Housing with Pressure Override and Speed Sensor
114192-000	1	Main Housing, No POR, Metric Ports

Models 5422/6422

PART NO.	QTY.	DESCRIPTION
111817-000	1	Main Housing, No POR, No Speed Sensor Port
111816-000	1	Main Housing, Pressure Override, No Speed Sensor Port
111815-000	1	Main Housing, Speed Sensor Port, No POR
111814-000	1	Main Housing, Pressure Override and Speed Sensor

Table 3.0 Drive Shaft Subassembly

Models 3322/3922/4622 (54, 64, 75 cc/rev.)

SUBASSEMBLY	SHAFT	BEARING CONE	RETAINING RING	DESCRIPTION
108029-000	108028-000	103227-000	103222-188	23 Tooth 16/32 Pitch Spline
108625-000	108624-000	103227-000	103222-188	14 Tooth 12/24 Pitch Spline
108646-000	108645-000	103227-000	103222-188	21 Tooth 16/32 Pitch Spline
109738-000	109737-000	103227-000	103222-188	23 Tooth 16/32 Pitch Spline 3/8-24 UNF 2B Tapped
113718-000	113717-000	103227-000	103222-188	14 Tooth 12/24 Pitch Spline Front of Tandem
113720-000	113719-000	103227-000	103222-188	27 Tooth 24/48 Pitch Spline
114681-000	114680-000	103227-000	103222-188	1.500" Taper With 3/8 Square Key
4992795-001	4992794-001	103227-000	103222-188	1.375" Taper With 3/8 Square Key
4998310-001	4998309-001	103227-000	103222-188	14 Tooth 24/48 pitch Spline

Models 5422/6422 (89, 105 cc/rev.)

SUBASSEMBLY	SHAFT	BEARING CONE	RETAINING RING	DESCRIPTION
109140-000	109139-000	103808-000	103222-200	14 Tooth 12/24 Pitch Spline
109512-000	109468-000	103808-000	103222-200	21 Tooth 16/32 Pitch Spline 3.22 ext.
110117-000	110116-000	103808-000	103222-200	21 Tooth 16/32 Pitch Spline
110133-000	110132-000	103808-000	103222-200	13 Tooth 8/16 Pitch Spline
112035-000	112034-000	103808-000	103222-200	1.50 Dia. Taper With 3/8 Square Key
112037-000	112036-000	103808-000	103222-200	27 Tooth 24/48 Pitch Spline
114890-000	114889-000	103808-000	103222-200	23 Tooth 16/32 Pitch Spline 3/8-24 UNF 2B Tapped
108382-000	108366-000	103808-000	103222-200	23 Tooth 16/32 Pitch Spline
4992795-001	4992794-001	103227-000	103222-188	1.50 Dia. Taper With .375" x 1" Square Key

* Includes 103227 Pressed Bearing Cone and 103222-188 Retaining Ring

** Includes 103808 Pressed Bearing Cone and 103222-200 Retaining Ring

Note: Bearing Cup must be replaced with shaft and new bearing cone.

Parts List

End Cover

(Item 3)

Opposite Side
Ported End Cover

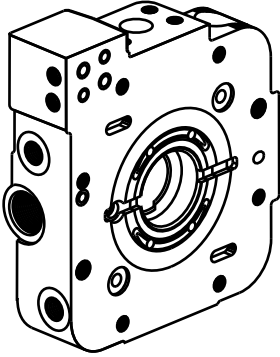

Table 4.0 End Cover

Opposite Side Ported End Cover

MODEL PUMP	PART NO.	MAIN PORTS	PRESSURE OVERRIDE	OPTIONS	
3322/3922	110568-000	Code 61	No	No Charge Pump	
	110619-000	Code 61	Yes	No Charge Pump	
	110300-000	Code 62, M12X1.75	No	No Charge Pump	
	110202-000	Code 62, M12X1.75	Yes	No Charge Pump	
	109766-000	Code 62	Yes	No Charge Pump	
	109493-000	Code 62	No	No Charge Pump	
	114348-000	Code 61	Yes	Remote Filter Ports	
	110718-000	Code 62	No	Remote Filter Ports	
	108896-000	Code 62	Yes	Remote Filter Ports	
	4622	108859-000	Code 62	Yes	Remote Filter Ports
110560-000		Code 62	No	Remote Filter Ports	
110628-000		Code 61	Yes		
110301-000		Code 62, M12 X 1.75	No		
110201-000		Code 62, M12 X 1.75	Yes		
109470-000		Code 62	No		
109147-000		Code 62	Yes		
112548-000		Code 61	Yes	Remote Filter Ports	
5422		4997280-001	Code 61	No	Remote Filter Ports
		110190-000	Code 62	Yes	Remote Filter Ports
	110302-000	Code 62, M12 X 1.75	No	7/8-14 UNF Charge pressure Gauge Port	
	110356-000	Code 62	No	Remote Filter Ports	
	110434-000	Code 62, M12 X 1.75	Yes	7/8-14 UNF Charge pressure Gauge Port	
5422	110358-000	Code 61	Yes	Remote Filter Ports	
	110541-000	Code 61	Yes		
	110356-000	Code 62	No	Remote Filter Ports	
	110270-000	Code 61	No		
	109783-000	Code 62	Yes		
	109784-000	Code 62	Yes	Remote Filter Ports	
	109281-000	Code 62	No		
	109400-000	Code 62	No	Pressure Transducer	
	6422	108344-000	Code 62	Yes	
		4998511-001	Code 62, M12 X 1.75	No	Pressure Transducer/7/8-14 UNF Charge pressure Gauge Port
110303-000		Code 62	No	7/8-14 UNF Charge pressure Gauge Port	
110435-000		Code 62, M12 X 1.75	Yes	7/8-14 UNF Charge pressure Gauge Port	
111670-000		Code 62, M12 X 1.75	No	M33 Charge Inlet, M22 Gauge Port	
114875-000		Code 61	No	7/8-14 UNF Charge pressure Gauge Port	
109176-000		Code 62	No		
109145-000		Code 62	No	Pressure Transducer	
109742-000		Code 62	Yes	Remote Filter Ports	
109845-000		Code 62, M12X1.75	Yes	Pressure Side Filter	
110322-000	Code 62	No	Remote Filter Ports		
110357-000	Code 61	Yes	Remote Filter Ports		

***Note:** All end covers include normal SAE-4 gauge ports for "A" & "B" high pressure ports.
(Except as noted)

Parts List

End Cover

(Item 3)

Same Side Ported End Cover

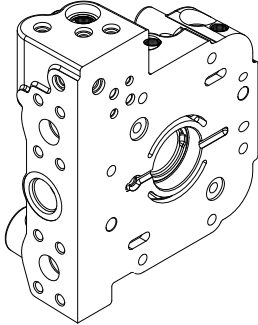

Model 3322-4622

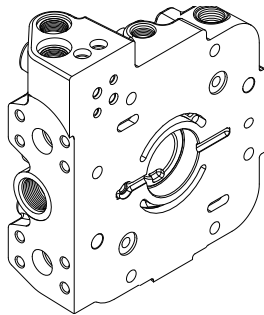

Model 5422-6422

Table 4.1

Same Side Ported End Cover

MODEL PUMP	PART NO.	MAIN PORTS	PRESSURE OVERRIDE	OPTIONS
3322/3922	114516-000	Code 62	Yes	
	113421-000	Code 61	No	Remote Filter Ports
	113194-000	Code 62	Yes	Remote Filter Ports – Labeled
	112206-000	Code 62	No	
	112870-000	Code 62	Yes	Remote Filter Ports
	113731-000	Code 62	No	Remote Filter Ports
	4992179-001	Code 61	Yes	Integral C-pad/No Charge Pump/ Gauge Ports
	4994477-001	Code 62	Yes	Integral C-pad/No Charge Pump
	113703-000	Code 62	No	Integral C-pad/Pressure Transducer M33 Charge Inlet/ M22 Gauge Metric Ports
	4992178-001	Code 61	Yes	
	4993403-001	Code 62	No	M33 Charge Inlet, M22/Gauge Metric Ports
	4994225-001	Code 62	No	Remote Filter Ports
	4997704-001	Code 62, M12x1.75	No	
	114194-000	Code 62	Yes	Pressure Side Filter
	114543-000	Code 62	Yes	Remote Filter Ports 3/4-16 UNF
	4992179-001	Code 62	Yes	Integral C-pad/No Charge Pump Gauge Ports
	114693-000	Code 62	Yes	Integral C-pad/No Charge Pump Gauge Ports
	4994224-001	Code 62	Yes	Integral C-pad/No Charge Pump
	114693-000	Code 62	Yes	Integral C-pad/No Charge Pump Gauge Ports
	4622	4997058-001	Code 61	No
112596-000		Code 62	Yes	
113721-000		Code 61	No	Integral C-pad
113728-000		Code 61	No	
4992768-001		Code 62	No	
4992902-001		Code 62	Yes	Remote Filter Ports
113721-000		Code 61	Yes	Integral C-pad/No Charge Pump
4993725-001		Code 62	Yes	Integral C-pad/No Charge Pump
113651-000		Code 62	Yes	Integral C-pad/Gauge Ports
113652-000		Code 62	Yes	Remote Filter Ports
5422	113651-000	Code 62	Yes	No Charge Pump/Gauge Ports
	4997280-001	Code 61	No	Remote Filter Ports
6422	112056-000	Code 62	Yes	Diag Fitting Ports /Integrated C-pad
	111747-000	Code 62	Yes	Diag Fitting Ports
	114752-000	Code 62	No	Remote Filter Ports
	4992200-001	Code 61	No	Remote Filter Ports
	4997088-001	Code 61	Yes	Remote Filter Ports
	4997956-001	Code 61	Yes	Remote Filter Ports
	111005-000	Code 61	Yes	7/8-14 UNF/ Charge Pressure Gauge Port
	4992804-001	Code 62	No	Integral C-pad
	112056-000	Code 62	Yes	Integral C-pad/ Gauge Port

***Note:** All end covers include normal SAE-4 gauge ports for “A” & “B” high pressure ports. (Except as noted)

Parts List

Control Valve Sub-assemblies

(Item 6)

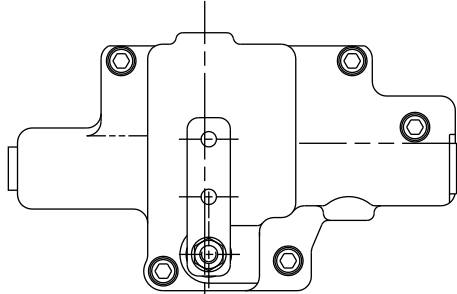

Manual Control

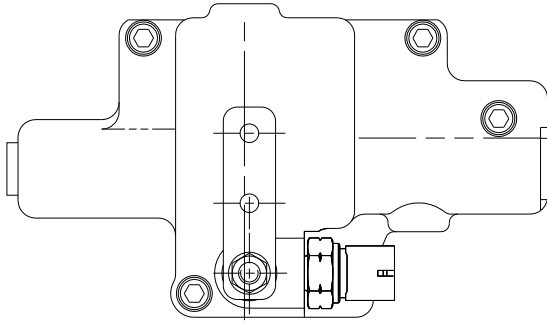

Manual Control with Neutral Lockout Switch

Manual Control with Neutral Lockout Switch and wide Land Spool

ITEM	PART NO.	DESCRIPTION
6	4992658-000	Pump Control Valve S/A

Manual Control with Neutral Detent

ITEM	PART NO.	DESCRIPTION
6	4994825-001	Pump Control Valve S/A W/ Neutral Detent

Table 5.0 Manual Control Kit

Kit No. 990704-000

ITEM	PART NO.	QTY.	DESCRIPTION
6	110038-001	1	Manual Control Valve Subassembly
7	108992-000	1	Control Gasket
8	95912-088	1	Cap Screw SOC HD 5/16-18 GR 8
9	95912-150	4	Cap Screw SOC HD 5/16-18 GR 8
70	111402-000	1	Control Link Subassembly
71	96081-031	1	Nut 5/16-18
72	96100-031	1	Washer
73	95729-000	1	Control Lever
73a	103048-000	1	Control Lever (Optional)

Table 5.1 Manual Control Valve Wide Band Neutral Kit

Kit No. 990708-000

ITEM	PART NO.	QTY	DESCRIPTION
6	110038-002	1	Manual Control Valve Subassembly Wide Band Subassembly
7	108992-000	1	Control Gasket
8	95912-088	1	Cap SOC HD 5/16-18 GR 8
9	95912-150	4	Cap Screw SOC HD 5/16-18 GR 8
70	111402-000	1	Control Link Subassembly
71	96081-031	1	Nut 5/16-18
72	96100-031	1	Washer
73	95729-000	1	Control Lever
73a	103048-000	1	Control Lever (Optional)

Table 5.2 Manual Control Valve with N/C Neutral Lockout Kit

Kit No. 990705-000

ITEM	PART NO.	QTY	DESCRIPTION
6	110039-000	1	Manual Control Valve with N/C Neutral Lockout
7	108992-000	1	Control Gasket
8	95912-088	1	Cap Screw SOC HD 5/16-18 GR 8
9	95912-150	4	Cap Screw SOC HD 5/16-18 GR 8
70	111402-000	1	Control Link Subassembly
71	96081-031	1	Nut 5/16-18
72	96100-031	1	Washer
73	95729-000	1	Control Lever
73a	103048-000	1	Control Lever (Optional)

Table 5.3 Neutral Lockout Switch Mating Connector Kit

Kit No. 990764-000

PART NO.	QTY.	REFERENCE DELPHI PACKARD P/N
Connector	1	1201 5792
Terminal	2	1208 9040
Cable Seal	2	1201 5323

Recommended wire size: 18 - 20 AWG
 Recommended cable diameter: 2.03 - 2.80 mm
 Alternate reference source: Power and Signal Group
 North American Headquarters
 1-800-722-5273
www.powerandsignal.com/netstore/start

Parts List

Control Sub-assemblies

(Item 6)

Solenoid Control W/ Swashplate Feedback Sensor

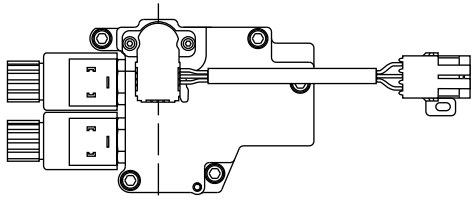

"SE" is 12 Volt with connectors per DIN 43650

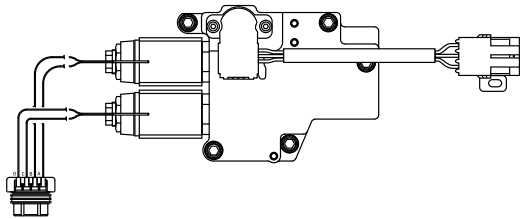

12 or 24 volt with 4 pin Metri-Pack™ connector

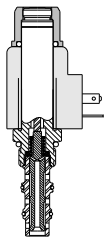

Proportional Solenoid Cartridge Valve

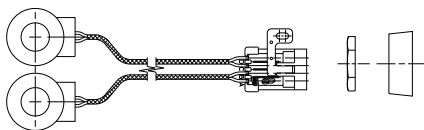

Solenoid Coil Subassembly

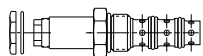

Solenoid Tube Subassembly

Table 5.4 Solenoid Control Kits

Kit No. 990718-000 24Vdc Solenoid Control with Swashplate Feedback Sensor 14 pin Metri-Pack™ Connector

ITEM	PART NO.	QTY	DESCRIPTION
6	110114-000	1	Subassembly includes:
	111406-024*	1	24Vdc Coil Subassembly
	108724-000*	1	Proportional Solenoid Cartridge
7	108876-000	1	Control Gasket
8	95912-125	4	Cap Screw SOC HD 5/16-18 GR 8
9	95912-150	4	Cap Screw SOC HD 5/16-18 GR 8
	990719-000	1	Swashplate Sensor Kit
92	109195-000	1	Feedback Shaft Subassembly
93	8761-010	1	O-Ring
94	109196-000	1	Hollow Dowel

Kit No. 990693-000 SF 12 Vdc Control with Swashplate Feedback Sensor 14 pin Metri-Pack™ Connector

ITEM	PART NO.	QTY	DESCRIPTION
6	109124-000	1	Subassembly includes:
	111406-012*	1	12Vdc Coil Subassembly
	108724-000*	1	Proportional Solenoid Cartridge
7	108876-000	1	Control Gasket
8	95912-125	4	Cap Screw SOC HD 5/16-18 GR 8
9	95912-150	4	Cap Screw SOC HD 5/16-18 GR 8
	990719-000	1	Swashplate Sensor Kit
92	109195-000	1	Feedback Shaft Subassembly
93	8761-010	1	O-Ring
94	109196-000	1	Hollow Dowel

* Can be purchased separately

Kit No. 990863-000 Solenoid 12Vdc Control W/Swashplate Feedback Sensor (DIN 43650)

ITEM	PART NO.	QTY	DESCRIPTION
6	113226-012	1	Solenoid (12V W/ Feedback Sensor)
	111406-012*	1	12Vdc Coil Subassembly
	108724-000*	1	Proportional Solenoid Cartridge
7	108992-000	1	Control Gasket (Man/Sol)
8	95912-125	2	Cap Screw SOC HD 5/16-18 GR 8
9	95912-175	3	Cap Screw SOC HD 5/16-18 GR 8
90	95897-008	2	Washer
92	109195-000	1	Feedback Shaft S/A
93	8761-010	1	O-Ring
94	109196-000	1	Hollow Dowel
88	113334-001	1	Feedback Sensor, Non-Contact
89	95890-150	2	Screw, Socket Head Cap 8-32 UNC
91	8761-116	1	O-Ring
130	101673-025	1	Screw, Cap Soc Hd 10-24 UNC

Kit No. 990719-000 Swashplate Sensor Kit

ITEM	PART NO.	QTY	DESCRIPTION
88	107851-000	1	Swashplate Sensor
89	16040-208	2	SF Head Machine Screw 8-32 UN
90	95897-008	2	Washer
91	107762-000	1	Swashplate Gasket

Parts List

(Item 6)

Table 5.5 Connector Kits

Kit No. 990763-000 Swashplate Sensor Mating Connector

PART	QTY.	DELPHI PACKARD P/N
Connector	1	1201 0717
Terminal	3	1208 9040
Cable Seal	3	1208 9679

Recommended wire size: 18 - 20 AWG
 Recommended cable diameter: 1.6 - 2.15 mm
 Alternate reference source: Power and Signal Group
 North American Headquarters
 1-800-722-5273
www.powerandsignal.com/netstore/start

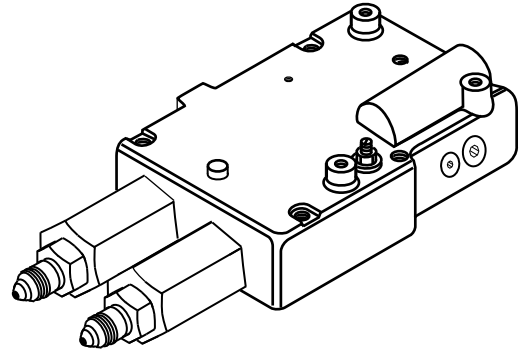

Table 5.6 Hydraulic Remote Control Kits

Kit No. 990789-000

Rating: 5-15 bar[73-218 lbf/in²]

ITEM	PART NO.	QTY	DESCRIPTION
6	110686-000	1	Hydraulic Remote Control Subassembly
7	110003-000	1	Gasket
8	95912-200	5	Cap Screw

Hydraulic Remote (parts sold separately)

Rating: 2-14 bar[29-203 lbf/in²]

ITEM	PART NO.	QTY	DESCRIPTION
6	4993691-001	1	Hydraulic Remote Control Subassembly
7	110003-000	1	Gasket
8	95912-200	5	Cap Screw

Parts List

Electronic Proportional (EP) Control

Table 6.0 Electronic Proportional (EP) Displacement Control Valve Kits

EP Control Assembly
(includes solenoid and
Coil Subassemblies)

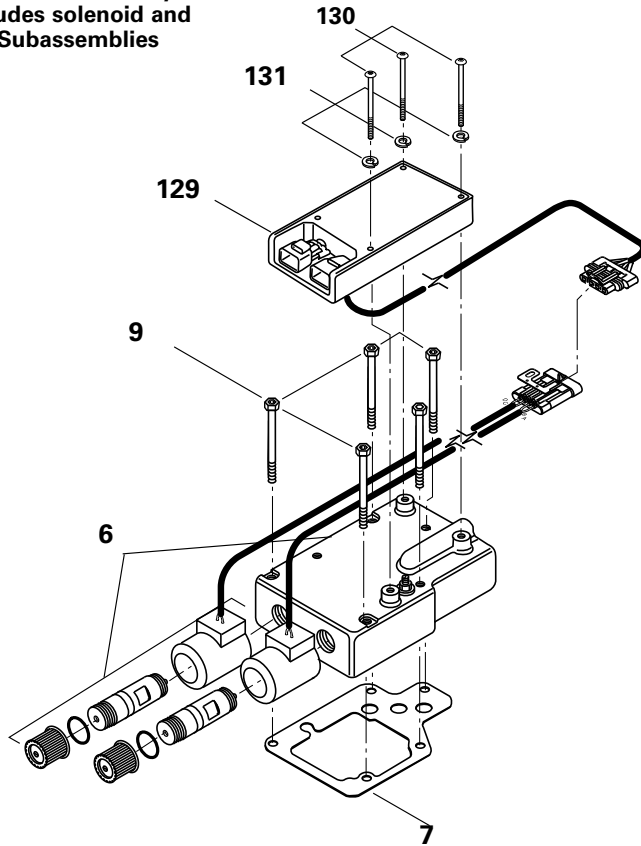

EP Control Electronic Module 1-6V Input

Kit No. 990830-000

ITEM	PART NO.	QTY	DESCRIPTION
129	111520-016	1	Electronic Module
130	101673-175	3	10-24 Button Head Cap Screw
131	16045-203	3	#10 Lockwasher

EP Control Electronic Module ±4-20mA Input

Kit No. 990832-000

ITEM	PART NO.	QTY	DESCRIPTION
129	111520-020	1	Electronic Module
130	101673-175	3	10-24 Button Head Cap Screw
131	16045-203	3	#10 Lockwasher

EP Control Valve Kit with electronic module 1-6 V Input, 12/24 V

Kit No. 990040-000 Code "EE"

ITEM	PART NO.	QTY.	DESCRIPTION
129	111520-016	1	Electronic Module
130	101673-175	3	10-24 Button Head Cap Screw
131	16045-203	3	#10 Lockwasher
9	95912-200	5	5/16"-18 Hex Head Cap Screw - 2.75"
6	4993054-012	1	Valve Assembly (includes Solenoid Coil and Tube Subassemblies)
	111501-000	2	Solenoid Tube Subassembly
	114241-012	1	12 V Solenoid Coil and Wiring Harness
7	110003-000	1	Control Valve Gasket

*Includes necessary O-Rings.

EP Control Valve Kit with Electronic Module ±4-20mA Input, 12/24 V

Kit No. 990042-000 Code "EG"

ITEM	PART NO.	QTY.	DESCRIPTION
129	111520-020	1	Electronic Module
130	101673-175	3	10-24 Button Head Cap Screw
131	16045-203	3	#10 Lockwasher
4	95912-200	5	5/16"-18 Hex Head Cap Screw - 2.75"
6	4993054-012	1	Valve Subassembly (includes Solenoid Coil and Tube Subassemblies)
	114241-012	1	12 V Solenoid Coil and Wiring Harness
	111501-000	1	Solenoid Tube and O-Rings
7	110003-000	1	Control Valve Gasket

EP Control Valve Kit with no Electronics, 12V

Kit No. 990043-000 Code "EC"

ITEM	PART NO.	QTY	DESCRIPTION
4	95912-200	5	5/16"-18 Hex Head Cap Screw - 2.75"
6	4993054-012	1	Valve Subassembly (includes Solenoid Coil and Tube Subassemblies)
	114241-012	1	12 V Solenoid Coil and Wiring Harness
	111501-000	1	Solenoid Tube and O-Rings
7	110003-000	1	Control Valve Gasket

EP Control Valve Kit with no Electronics, 24 V

Kit No. 990044-000 Code "ED"

ITEM	PART NO.	QTY	DESCRIPTION
4	95912-200	5	5/16"-18 Hex Head Cap Screw - 2.75"
6	4993054-024	1	Valve Subassembly (includes Solenoid Coil and Tube Subassemblies)
	114241-024	1	24 V Solenoid Coil and Wiring Harness
	111501-000	1	Solenoid Tube and O-Rings
7	110003-000	1	Control Valve Gasket

Parts are included in kit and may be purchased separately.

Parts List

EP Connector Kits

Table 6.1 EP Connector Kits

EP Solenoid Mating Connector Kit

Kit No. 990767-000

DESCRIPTION	QTY.	DELPHI PACKARD PART NUMBER
Connector	1	1204 7950
Terminal	4	1204 8074
Cable Seal	4	1204 8086
Secondary Lock	1	1204 7948

Recommended wire size: 16 - 18 AWG
 Recommended cable diameter: 2.03 - 2.80 mm
 Alternate reference source: Power and Signal Group
 North American Headquarters
 1-800-722-5273
www.powerandsignal.com/netstore/start

Electronic Module Mating Connector Kit

Kit No. 990762-000

DESCRIPTION	QTY.	DELPHI PACKARD PART NUMBER
Command Input Signal Connector	1	1211 0293
Terminal	3	1204 8074
Cable Seal	3	1204 8086
Cavity Plug	1	1205 9168
Secondary Lock	1	1205 2845
Power Supply Connector	1	1205 2641
Terminal	2	1204 8074
Cable Seal	2	1204 8086
Secondary Lock	1	1205 2634

Recommended wire size: 16 - 18 AWG
 Recommended cable diameter: 2.03 - 2.80 mm
 Alternate reference source: Power and Signal Group
 North American Headquarters
 1-800-722-5273
www.powerandsignal.com/netstore/start

Solenoid Coil Mating Connector Kit

(not required when using an Eaton Electronic Module)

Kit No. 9900023-000

DESCRIPTION	QTY.	DELPHI PACKARD PART NUMBER
Connector	1	1218 6568
Terminal	4	1204 8074
Cable Seal	4	1204 8086
Secondary Lock	1	1204 7948

Recommended wire size: 16 - 18 AWG
 Recommended cable diameter: 2.03 - 2.80 mm
 Alternate reference source: Power and Signal Group
 North American Headquarters
 1-800-722-5273
www.powerandsignal.com/netstore/start

EP Control Electronic S/A Module

Mating Connector Kit 12V F-N-R Control

Kit No. 9900134-000

ITEM	PART NO.	QTY	DESCRIPTION
6	111615-000	1	Control Housing S/A 12VDC
	111074-000	2	Connector Housing
	108432-003	4	Sleeve Terminal
	105584-003	4	Seal Cable

Solenoid Connector Update Kit

Kit No.9900045-000

DESCRIPTION	QTY.	DELPHI PACKARD PART NUMBER
Tool	1	1209 4429
4-Pin Housing Connector (Female)	1	1218 6568
4-Pin Housing Connector (Male)	1	1218 6271

Parts List

Rotating Group/ Swashplate Sub-assembly (Standard Shoe)

(Item 12)

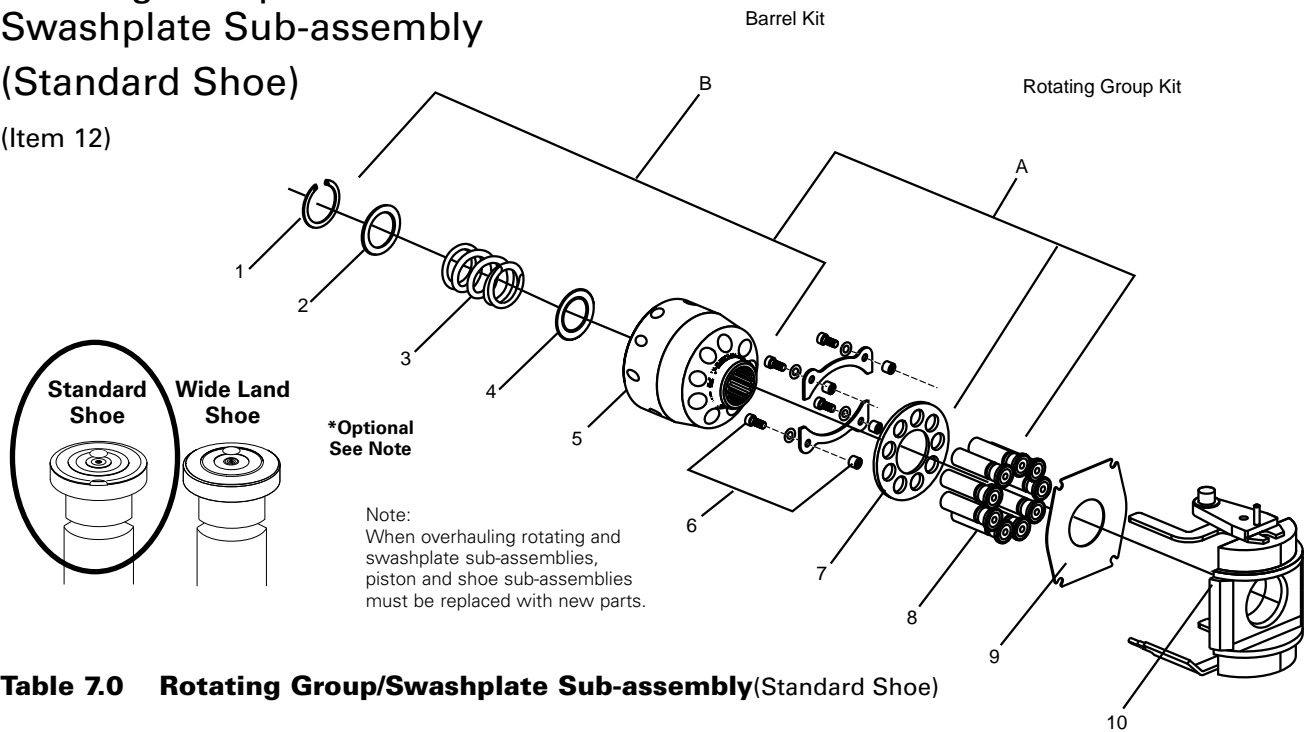

Table 7.0 Rotating Group/Swashplate Sub-assembly(Standard Shoe)

Models 3322/3922

Complete Rotating/Swashplate

Kit No. 109752-000

ITEM	PART NO.	QTY.	DESCRIPTION
A	110428-000	1	Rotating Group Kit (includes items B, 7 and 8)
B	990730-000	1	Barrel Kit (includes items 1 through 5)
1	103278-200	1	Retaining Ring
2	103242-000	1	Spacer Cyl Barrel Spring
3	103240-000	1	Cylinder Barrel Spring
4	107758-000	1	Spacer Shaft Spring
5	109427-000	1	Barrel and Sleeve
6	990723-000	1	Hold-down Kit
7	103244-000	1	Shoe Retainer Plate
8	101073-000	9	Shoe Piston Subassembly
9	107854-000	1	Fixed Clr Thrust Plate
10	109366-000	1	Swashplate Subassembly

Model 4622

Complete Rotating/Swashplate

Kit No. 109367-000

ITEM	PART NO.	QTY.	DESCRIPTION
A	109419-000	1	Rotating Group Kit (includes items B, 7 and 8)
B	990731-000	1	Barrel Kit (includes items 1 through 5)
1	103278-200	1	Retaining Ring
2	103242-000	1	Spacer Cyl Barrel Spring
3	103240-000	1	Cylinder Barrel Spring
4	107758-000	1	Spacer Shaft Spring
5	109418-000	1	Barrel and Sleeve
6	990723-000	1	Hold-down Kit
7	104211-000	1	Shoe Retainer Plate
8	104199-000	9	Shoe Piston Subassembly
9	107854-000	1	Fixed Clr Thrust Plate
10	109366-000	1	Swashplate Subassembly

Model 5422

Complete Rotating/Swashplate

Kit No. 108424-000

ITEM	PART NO.	QTY.	DESCRIPTION
A	109431-000	1	Rotating Group Kit (includes items B, 7 and 8)
B	990732-000	1	Barrel Kit (includes items 1 through 5)
1	103278-225	1	Retaining Ring
2	103815-000	1	Spacer Cyl Barrel Spring
3	103813-000	1	Cylinder Barrel Spring
4	108337-000	1	Spacer Shaft Spring
5	109430-000	1	Barrel and Sleeve
6	990724-000	1	Hold-down Kit
7	103853-000	1	Shoe Retainer Plate
8	101077-000	9	Shoe Piston Subassembly
9	108341-000	1	Fixed Clr Thrust Plate
10	109254-000	1	Swashplate Subassembly

Model 6422

Complete Rotating/Swashplate

Kit No. 109435-000

ITEM	PART NO.	QTY.	DESCRIPTION
A	109434-000	1	Rotating Group Kit (includes items B, 7 and 8)
B	990733-000	1	Barrel Kit (includes items 1 through 5)
1	103278-225	1	Retaining Ring
2	103815-000	1	Spacer Cyl Barrel Spring
3	103813-000	1	Cylinder Barrel Spring
4	108337-000	1	Spacer Shaft Spring
5	109433-000	1	Barrel and Sleeve
6	990724-000	1	Hold-down Kit
7	103817-000	1	Shoe Retainer Plate
8	103818-000	9	Shoe Piston Subassembly
9	108341-000	1	Fixed Clr Thrust Plate
10	109254-000	1	Swashplate Subassembly

Parts List

Rotating Group/ Swashplate Sub-assembly (Wide Land Shoe)

(Item 12)

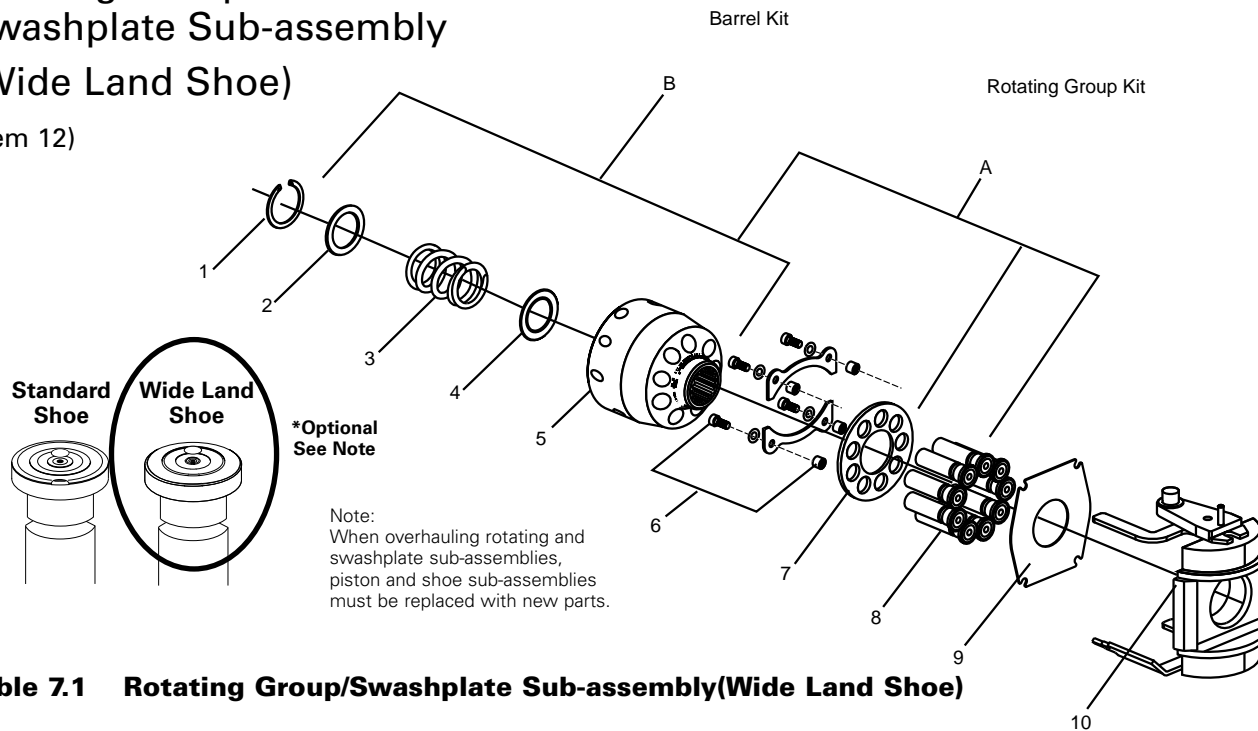

Table 7.1 Rotating Group/Swashplate Sub-assembly(Wide Land Shoe)

Models 3322/3922

Complete Rotating/Swashplate

Kit No. 110292-000

ITEM	PART NO.	QTY.	DESCRIPTION
A	110291-000	1	Rotating Group Kit (includes items B, 7 and 8)
B	990730-000	1	Barrel Kit (includes items 1 through 5)
1	103278-200	1	Retaining Ring
2	103242-000	1	Spacer Cyl Barrel Spring
3	103240-000	1	Cylinder Barrel Spring
4	107758-000	1	Spacer Shaft Spring
5	109427-000	1	Barrel and Sleeve
6	990723-000	1	Hold-down Kit
7	103244-000	1	Shoe Retainer Plate
8	110216-000	9	Shoe Piston Subassembly
9	107854-000	1	Fixed Clr Thrust Plate
10	109366-000	1	Swashplate Subassembly

Model 5422

Complete Rotating/Swashplate

Kit No. 110290-000

ITEM	PART NO.	QTY.	DESCRIPTION
A	110289-000	1	Rotating Group Kit (includes items B, 7 and 8)
B	990732-000	1	Barrel Kit (includes items 1 through 5)
1	103278-225	1	Retaining Ring
2	103815-000	1	Spacer Cyl Barrel Spring
3	103813-000	1	Cylinder Barrel Spring
4	108337-000	1	Spacer Shaft Spring
5	109430-000	1	Barrel and Sleeve
6	990724-000	1	Hold-down Kit
7	103853-000	1	Shoe Retainer Plate
8	110220-000	9	Shoe Piston Subassembly
9	108341-000	1	Fixed Clr Thrust Plate
10	109254-000	1	Swashplate Subassembly

Model 4622

Complete Rotating/Swashplate

Kit No. 110563-000

ITEM	PART NO.	QTY.	DESCRIPTION
A	110562-000	1	Rotating Group Kit (includes items B, 7 and 8)
B	990731-000	1	Barrel Kit (includes items 1 through 5)
1	103278-200	1	Retaining Ring
2	103242-000	1	Spacer Cyl Barrel Spring
3	103240-000	1	Cylinder Barrel Spring
4	107758-000	1	Spacer Shaft Spring
5	109418-000	1	Barrel and Sleeve
6	990723-000	1	Hold-down Kit
7	104211-000	1	Shoe Retainer Plate
8	106609-000	9	Shoe Piston Subassembly
9	107854-000	1	Fixed Clr Thrust Plate
10	109366-000	1	Swashplate Subassembly

Model 6422

Complete Rotating/Swashplate

Kit No. 110546-000

ITEM	PART NO.	QTY.	DESCRIPTION
A	110545-000	1	Rotating Group Kit (includes items B, 7 and 8)
B	990733-000	1	Barrel Kit (includes items 1 through 5)
1	103278-225	1	Retaining Ring
2	103815-000	1	Spacer Cyl Barrel Spring
3	103813-000	1	Cylinder Barrel Spring
4	108337-000	1	Spacer Shaft Spring
5	109433-000	1	Barrel and Sleeve
6	990724-000	1	Hold-down Kit
7	103817-000	1	Shoe Retainer Plate
8	110222-000	9	Shoe Piston Subassembly
9	108341-000	1	Fixed Clr Thrust Plate
10	109254-000	1	Swashplate Subassembly

Parts List

Hold-down Kits and Valve Plate

Table 8.0 Hold-down Kit

Models 3322/3922/4622

Kit No. 990723-000

PART NO.	QTY.	DESCRIPTION
95912-100	4	Cap Screw 5/16-18
108377-000	4	Washer
107858-000	2	Hold-down Strap
103237-001	4	Spacer

Models 5422/6422

Kit No. 990724-000

PART NO.	QTY.	DESCRIPTION
95912-125	4	Cap Screw 5/16-18
108377-000	4	Washer
108340-000	2	Hold-down Strap
103237-002	4	Spacer

Valve Plate

(Item 13)

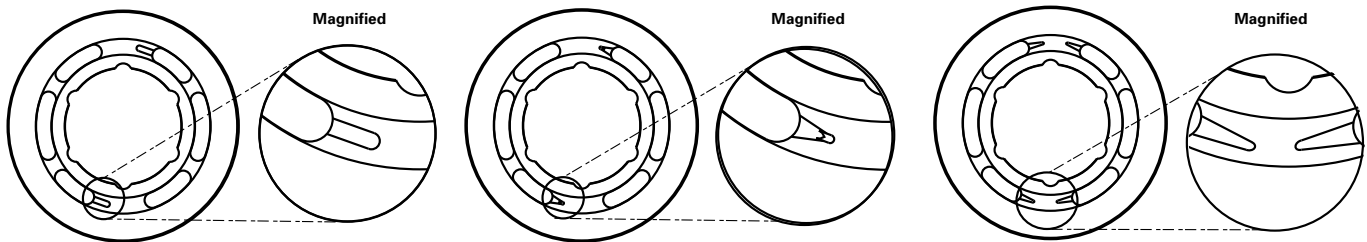

CW Propel Valve Plate

CW V-Groove Plate

CW Quiet Plate

Table 9.0 Valve Plate

(Item 17)

MODEL 3322/3922 PART NO.	MODEL 4622 PART NO.	MODEL 5422 PART NO.	MODEL 6422 PART NO.	DESCRIPTION
107224-000	107784-000	103848-000	103976-000	Propel Valve Plate (Counterclockwise)
106458-000	106459-000	104297-000	103950-000	Propel Valve Plate (Clockwise)
106988-000	107808-000	104857-000	107143-000	V-Groove Plate (Counterclockwise)
106456-000	106457-000	104964-000	104006-000	V-Groove Plate (Clockwise)
111823-001	4993532-001	4993881-001	114557-000	Quiet Plate (Counterclockwise)
113169-000	113632-000	113148-000	112375-000	Quiet Plate (Clockwise)

Parts List

Charge Pump Sub-assembly

(Item 15)

Table 10.0

Charge Pump/Auxiliary Mount

ITEM	QTY.	DESCRIPTION
97	4	Adapter Bolts
105	1	Flange O-Ring Cust.
95	1	Pad Adapter
96	1	Adapter O-Ring
20	4	Charge Cover Bolts
19	4	Sealing Washers
18	1	Charge Cover Subassembly
24	1	Charge Cover O-Ring
21	1	Shaft
22	1	Key
23	1	Retaining Ring
15	1	Eccentric Ring
16	1	Gerotor Subassembly
17	1	Valve Plate

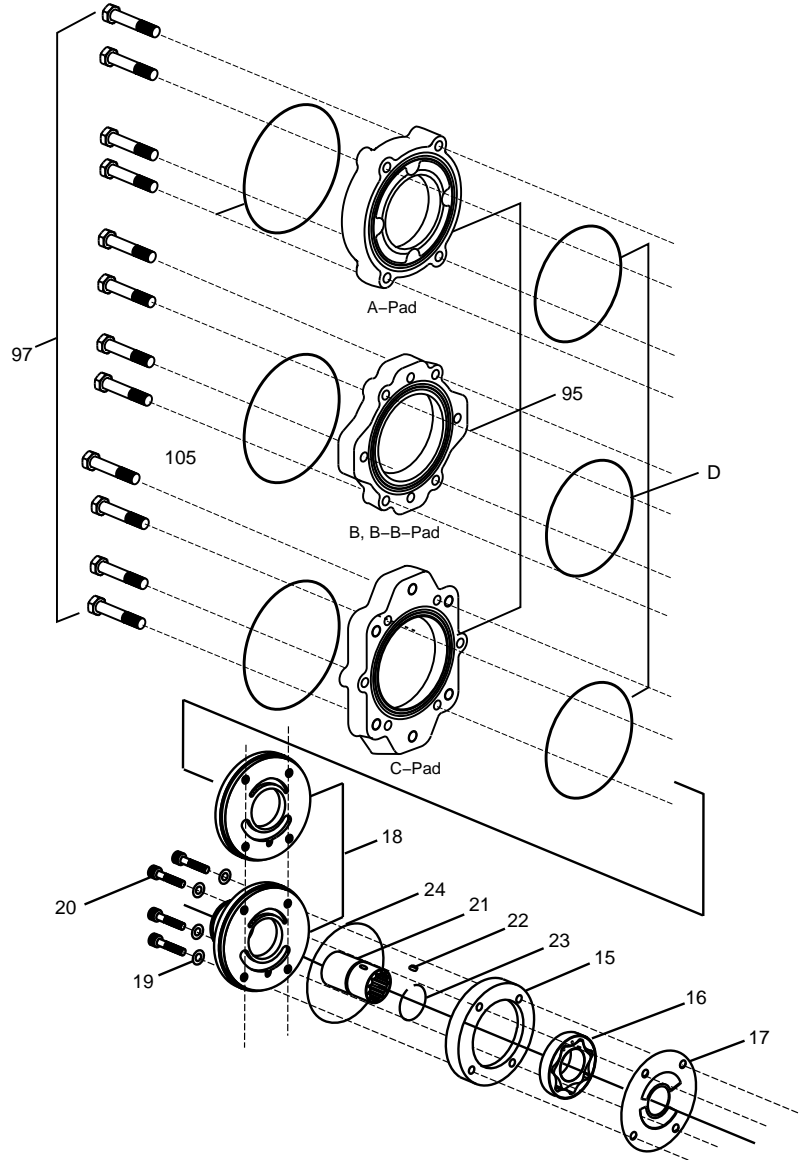

SAE A-pad Auxiliary Mounting Adapter

Charge Pump, Dual 2 Bolt Mount,
No Shaft Seal, 9 Tooth 16/32 Pitch Spline

SAE B-pad Auxiliary Mounting Adapter

Charge Pump, Dual 2 Bolt Mount,
No Shaft Seal, 13 Tooth 16/32 Pitch Spline

SAE B-B-pad Auxiliary Mounting Adapter

Charge Pump, Dual 2 Bolt Mount,
No Shaft Seal, 15 Tooth 16/32 Pitch Spline

SAE C-pad Auxiliary Mounting Adapter

Charge Pump, 4 Bolt Mount, No Shaft Seal,
14 Tooth 12/24 Pitch Spline

Table 10.1 Charge Pump/Auxiliary Mount Kits

Kits With No Auxiliary Mounting Adapter

KIT NO.	DISPLACEMENT	CHARGE ADAPTER O-RING 96	CHARGE COVER BOLTS 20	CHARGE SEALING WASHERS 19	COVER SUBASSY 18	CHARGE COVER O-RING 24	SHAFT 21	KEY 22	RETAINING RING 23	ECCENTRIC RING 15	GEROTOR SUBASSY PLATE 16	VALVE 17
990665-000	14cc/.85 CID	—	95912-150	103223-000	108026-000	8761-157	109302-001	101305-000	109312-000	107882-001	107881-001	108362-000
990677-000	14cc/.85 CID	—	95912-150	103223-000	108026-000	8761-157	109302-001	101305-000	109312-000	—	—	—
9900067-000	17cc/1.06 CID	8761-159	95912-175	103223-000	108026-000	8761-157	109302-003	101311-000	109312-000	107882-003	107881-003	—
9900068-000	17cc/1.06 CID	—	95912-175	103223-000	108026-000	8761-157	109303-002	101305-000	109312-000	—	—	—
990666-000	21cc/1.28 CID	—	95912-175	103223-000	108026-000	8761-157	109302-003	101311-000	109312-000	107882-003	107881-003	—
990678-000	21cc/1.28 CID	—	95912-175	103223-000	108026-000	8761-157	109302-003	101311-000	109312-000	—	—	—
990667-000	28cc/1.70 CID	—	95912-200	103223-000	108026-000	8761-157	109302-004	101311-000	109312-000	107882-004	107881-004	108362-000
990679-000	28cc/1.70 CID	—	95912-200	103223-000	108026-000	8761-157	109302-004	101311-000	109312-000	—	—	—
990673-000	28cc/1.70 CID	—	95912-200	—	108027-000	8761-157	109302-002	101311-000	109312-000	107882-004	107881-004	—

Parts List

Kits With SAE A Auxiliary Mounting Adapter (9 Tooth 16/32 Pitch Spline)

KIT NO.	DISPLACEMENT	ADAPTER BOLT 97	FLANGE O-RING CUST. 105	CHARGE PAD ADAPTER 95	ADAPTER O-RING 96	CHARGE COVER BOLTS 20	CHARGE COVER SUBASSY 18	COVER O-RING 24	SHAFT 21	KEY 22	RETAINING RING 23	ECCENTRIC RING 15	GEOROTOR SUBASSY 16	VALVE PLATE 17
990680-000	14c/1.85 CID	103090-125	8761-042	108075-000	8761-159	95912-150	108027-000	8761-157	109303-001	101305-000	109312-000	-	-	-
990686-000	14c/1.85 CID	-	8761-042	-	8761-159	95912-150	108027-000	8761-157	109303-001	101305-000	109312-000	107882-001	107881-001	-
990069-000	17c/1.06 CID	-	8761-042	-	8761-159	95912-175	108027-000	8761-157	109302-002	101305-000	109312-000	107882-002	107881-002	-
990070-000	17c/1.06 CID	103090-125	8761-042	108075-000	8761-159	95912-175	108027-000	8761-157	109303-001	101305-000	109312-000	-	-	-
990681-000	21c/1.28 CID	103090-125	8761-042	108075-000	8761-159	95912-175	108027-000	8761-157	109303-002	101311-000	109312-000	-	-	-
990689-000	21c/1.28 CID	-	8761-042	-	8761-159	95912-175	108027-000	8761-157	109303-002	101311-000	109312-000	107882-003	107881-003	108362-000
990682-000	28c/1.70 CID	103090-125	8761-042	108075-000	8761-159	95912-200	108027-000	8761-157	109303-002	101311-000	109312-000	-	-	-
990670-000	28c/1.70 CID	-	8761-042	-	8761-159	95912-200	108027-000	8761-157	109303-002	101311-000	109312-000	107882-004	107881-004	-

Kits With SAE B Auxiliary Mounting Adapter (13 Tooth 16/32 Pitch Spline)

KIT NO.	DISPLACEMENT	ADAPTER BOLT 97	FLANGE O-RING CUST. 105	CHARGE PAD ADAPTER 95	ADAPTER O-RING 96	CHARGE COVER BOLTS 20	CHARGE COVER SUBASSY 18	COVER O-RING 24	SHAFT 21	KEY 22	RETAINING RING 23	ECCENTRIC RING 15	GEOROTOR SUBASSY 16	VALVE PLATE 17
990671-000	14c/1.85 CID	-	8761-045	-	-	95912-150	108027-000	8761-157	109304-001	101305-000	109312-000	107882-001	107881-001	-
990683-000	14c/1.85 CID	103090-125	8761-045	108076-000	8761-159	95912-150	108027-000	8761-157	109304-001	101305-000	109312-000	-	-	-
990073-000	17c/1.06 CID	-	8761-042	-	8761-159	95912-175	108027-000	8761-157	109304-001	101305-000	109312-000	107882-002	107881-002	108362-000
990074-000	17c/1.06 CID	-	8761-042	108076-000	8761-159	95912-175	108027-000	8761-157	109304-001	101305-000	109312-000	-	-	-
990672-000	21c/1.28 CID	-	8761-045	-	8761-159	95912-175	108027-000	8761-157	109304-002	101311-000	109312-000	107882-003	107881-003	108362-000
990684-000	21c/1.28 CID	103090-125	8761-045	108076-000	8761-159	95912-175	108027-000	8761-157	109304-002	101311-000	109312-000	-	-	-
990685-000	28c/1.70 CID	103090-125	8761-045	108076-000	8761-159	95912-200	108027-000	8761-157	109304-002	101311-000	109312-000	-	-	-

Kits With SAE B-B Auxiliary Mounting Adapter (15 Tooth 16/32 Pitch Spline)

KIT NO.	DISPLACEMENT	ADAPTER BOLT 97	FLANGE O-RING CUST. 105	CHARGE PAD ADAPTER 95	ADAPTER O-RING 96	CHARGE COVER BOLTS 20	CHARGE COVER SUBASSY 18	COVER O-RING 24	SHAFT 21	KEY 22	RETAINING RING 23	ECCENTRIC RING 15	GEOROTOR SUBASSY 16	VALVE PLATE 17
990686-000	14c/1.85 CID	103090-125	8761-045	108076-000	8761-159	95912-150	108027-000	8761-157	109305-001	101305-000	109312-000	-	-	-
990674-000	14c/1.85 CID	-	-	-	-	95912-150	108027-000	8761-157	109305-001	101305-000	109312-000	107882-001	107881-001	-
990071-000	17c/1.06 CID	-	8761-042	-	8761-159	95912-175	108027-000	8761-157	109303-001	101305-000	109312-000	107882-002	107881-002	108362-000
990072-000	17c/1.06 CID	103090-125	8761-042	108076-000	8761-159	95912-175	108027-000	8761-157	109303-001	101305-000	109312-000	-	-	-
990687-000	21c/1.28 CID	103090-125	8761-045	108706-000	8761-159	95912-175	108027-000	8761-157	109305-002	101311-000	109312-000	-	-	-
990675-000	21c/1.28 CID	-	8761-045	-	8761-159	95912-175	108027-000	8761-157	109305-002	101311-000	109312-000	-	-	-
990676-000	28c/1.70 CID	103090-125	8761-045	108076-000	8761-159	95912-200	108027-000	8761-157	109305-002	101311-000	109312-000	107882-003	107881-003	108362-000
990688-000	28c/1.70 CID	103090-125	8761-045	108076-000	8761-159	95912-200	108027-000	8761-157	109305-002	101311-000	109312-000	-	-	-
-	35c/2.12 CID	-	8761-045	108076-000	8761-159	95912-225	108027-000	8761-159	109305-003	101312-000	109312-000	107882-005	107881-005	108362-000

Parts List

SAE C Auxiliary Mounting Adapter (14 Tooth 16/32 Pitch Spline)

KIT NO.	DISPLACEMENT	ADAPTER BOLT	FLANGE O-RING CUST.	CHARGE PAD ADAPTER	ADAPTER O-RING	CHARGE COVER BOLTS	CHARGE COVER SUBASSY	COVER O-RING	SHAFT	KEY	RETAINING RING	ECCENTRIC RING	GEROTOR SUBASSY	VALVE PLATE
		97	105	95	96	20	18	24	21	22	23	15	16	17
990742-000	14c/85 CID	104511-150	8761-159	108081-000	8761-159	*	108027-000	8761-157	109306-001	101311-000	109312-000	*	*	*
990743-000	21c/1.25 CID	104511-150	8761-159	108081-000	8761-159	*	108027-000	8761-157	109306-002	101311-000	109312-000	*	*	*
990791-000**	21c/1.25 CID	104511-150	-	111084-000	8761-159	-	108027-000	8761-157	109306-002	101311-000	109312-000	-	-	-
990743-000	28c/1.70 CID	104511-150	8761-159	108081-000	8761-159	*	108027-000	8761-157	109306-002	101311-000	109312-000	*	*	*
	35c/2.12CID	104511-150	8761-159	108081-000	8761-159	*	108027-000	-	109306-003	101312-000	109312-000	*	*	*

*When replacing use existing Bolts, Eccentric Ring , Gerotor Subassembly and Valve Plate.

**Metric Thread

NOTE: All Parts can be purchased separately.

SAE C Auxiliary Drive Integral Design (27 Tooth 24/48 Pitch Spline, No Charge Pump)

ITEM NO.	PART NO.	DESCRIPTION
21	112119-000	27 Tooth 24/48 Pitch Spline Coupling

Parts List

Servo Piston

(Item 26)

There are three types of Servo Pistons. They are NOT interchangeable.

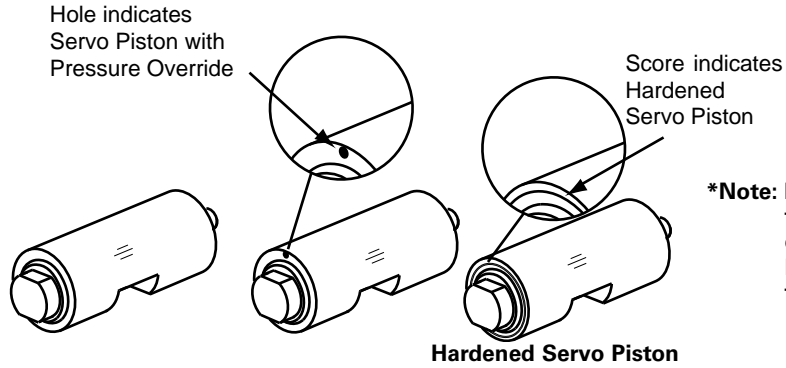

***Note:** Never disassemble the Servo Piston, critical calibrations have been made at the factory.

Table 11.0 Servo Piston

MODEL 3322 PART NO.	MODEL 3922 PART NO.	MODEL 4622 PART NO.	MODEL 5422 PART NO.	MODEL 6422 PART NO.	DESCRIPTION
109558-002	109558-001	109558-001	110018-000	110018-000	Servo Piston with Pressure Override
109559-002	109559-001	109559-001	110017-000	110017-000	Servo Piston
113241-001	113241-001	113241-001	113241-001	113241-001	Servo Piston,
4997993-002	4997993-001	4997993-001	4997664-000	4997664-000	Servo Piston, Hardened*
4997992-002	4997992-001	4997992-001	4997922-001	4997922-001	Servo Piston, Hardened* with Pressure Override

***Note:** Hardened servo Piston should be used in pumps with external displacement stops.

Servo Piston Cover

(Item 29)

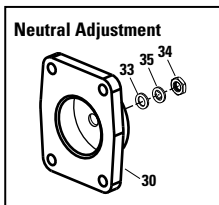

**Table 11.1
Standard Servo Piston Cover
Model 3322/3922/4622**

ITEM	PART NO.	DESCRIPTION
29	108145-000	Cover No Tap
30	109331-000	Cover .50-20

Model 5422/6422

ITEM	PART NO.	DESCRIPTION
29	108372-000	Cover No Tap
30	109371-000	Cover .50-20

**Table 11.2
Optional External Servo Stop Assembly
Model 3322/3922/4622**

ITEM	PART NO.	QTY	DESCRIPTION
111	16254-6	1	Thread Seal, with externally adjustable stop in one direction
110	16254-26	2	Washer
109	16021-6	1	Nut, Hex .375-16
108	111583-000	2	Set Screw .375-16
30	111581-000	1	Cover .375-16 Tap for Adjustable Stop
162	111582-000	1	Nut (Servo Stop)
29	111580-000	1	Cover .375-16 Tap for Servo Piston

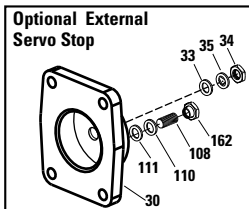

Model 5422/6422

ITEM	PART NO.	QTY	DESCRIPTION
111	16254-8	1	Thread Seal, with externally adjustable stop in one direction
110	16254-28	2	Washer
108	111830-000	1	Set Screw 1/2-20
162	96097-050	1	Nut 1/2-20
29	111864-000	1	Cover .50-20 Tap for Servo Piston
30	114220-000	1	Cover .50-20 Tap for Adjustable Stop

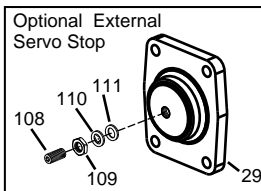

Parts List

Pressure Override Valve

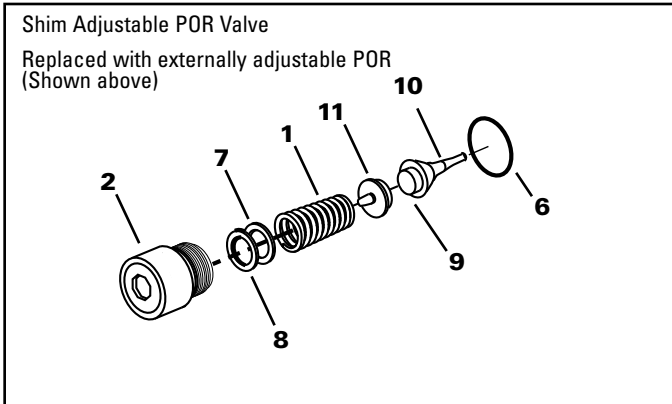
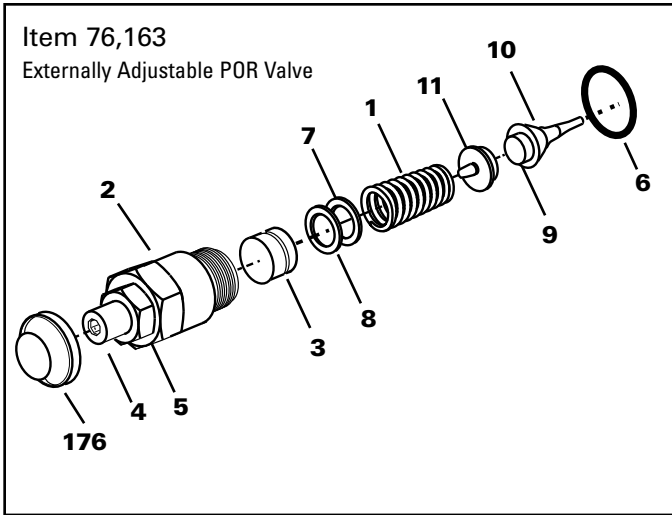

Table 12.0 Pressure Override Valve

4994730-XXX POR Relief Valve Assembly POR (Item 76, 163)

ITEM	PART NO.	QTY.	DESCRIPTION
11	4995049-001	1	Spring, Guide, POR
10	4996993-001	1	Seat, POR, S/A
9	4994960-001	1	Poppet, POR
8	8770-014	1	Back up Ring, Piston
7	8765-014	1	O-Ring, Piston
6	8765-020	1	O-Ring, Plug
5	16024-006	1	Jam Nut
4	16139-618	1	Set Screw, Half Dog
3	4994729-001	1	Piston, POR
2	4994545-001	1	Plug, POR
1	See Table 12.1		Valve Spring,

Table 12.1

POR Valve Pressure Setting Ranges

PART NO.	PRESSURE SETTING bar[lbf/in ²]	ITEM 1 PART No.	ADJUSTMENT RANGE (psi)
4994730-150	103,4[1500]		
4994730-200	137,9[2000]		
4994730-250	172,4[2500]	110732-350	1500-4000
4994730-300	206,8[3000]		
4994730-350	241,3[3500]		
4994730-400	275,8[4000]	110732-450	3500-5000
4994730-450	310,3[4500]		
4994730-500	344,7[5000]		
4994730-550	379,2[5500]	110732-550	4500-6000*
4994730-575	396,4[5750]		
4994730-600	413,7[6000]*		
4994730-650	448,1[6500]*	110732-650	5500-6000*

*Do not set to this pressure level without Eaton Engineering approval.

High Pressure Relief Valve

(Item 78,79)

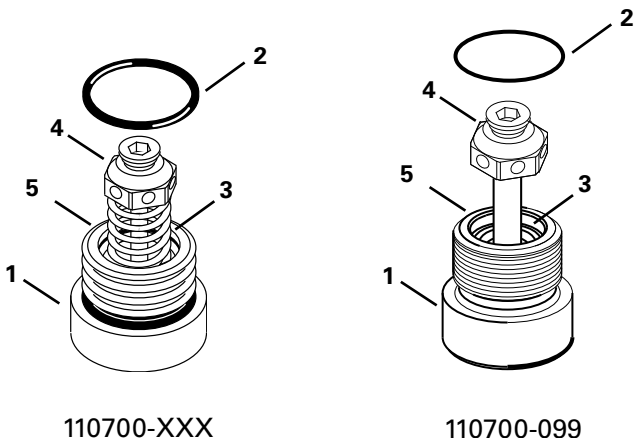

Table 13.0 High Pressure Relief Valve

110700-XXX Relief Valve Assembly

ITEM	PART NO.	QTY.	DESCRIPTION
1	113105-000	1	Plug, Relief Valve
2	16133-12	1	O-Ring
3	4992535-001	1	Spring Conical
4	See Table 13.1		Relief Valve S/A
5	4992534-001	1	Retaining Ring, Round Ext.

High Pressure Relief Valve Settings

Identify Pressure settings by the part number of the high pressure valve. The part number is followed by a dash and the related pressure rating, i.e., 110700-150. This setting represents a psi(lbf/in²) of 1500 lbf/in². Ranges for the high pressure relief valves are available from 1500 to 6000 lbf/in² in increments of 500 lbf/in².

Parts List

Series 2 Variable Piston Pump

Low Pressure Relief Valve Plug Subassembly

(Item 48)

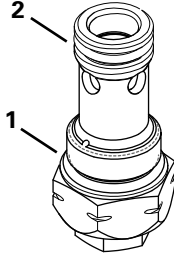

103072-XXX
111809-XXX

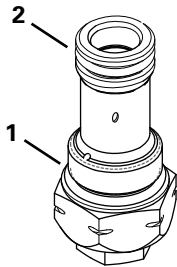

4993670-001

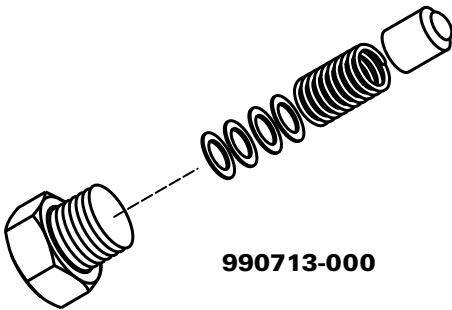

990713-000

Table 14.0

103072-XXX Sub-assembly

ITEM	PART NO.	QTY.	DESCRIPTION
1	8785-014	1	Tube Fitting
2	8765-117	1	O-ring

111809-XXX Damped Low Pressure Relief Valve Sub-assembly

ITEM	PART NO.	QTY.	DESCRIPTION
1	8785-014	1	Tube Fitting, O-Ring
2	8785-117	1	O-Ring

4993670-001 (Orificed) Low Pressure Relief Valve Sub-assembly

ITEM	PART NO.	DESCRIPTION
1	8785-014	Tube Fitting, O-Ring
2	8765-117	O-Ring

Table 14.1

Low Pressure Relief Valve (Item 1)

PART NO.	PRESSURE SETTING bar[lbf/in ²]
103072-030	20,7[300]
103072-032	22,1[320]
103072-033	22,5[326.3]
103072-034	23,4[340]
103072-035	24,1[350]
103072-037	25,5[369.8]
103072-038	26,2[380]
103072-040	27,0[391.6]
103072-041	28,3[410]
103072-043	30,0[435.1]

KIT NO. 990713-000 (Obsolete Design)

PART NO.	QTY.	DESCRIPTION
109077-00	1	LPRV Plug
8785-0121	1	O-Ring
108870-002	1	LPRV Spring
108869-000	1	LPRV Poppet
16048-253	10	*Shim (.020)

* Number of shims required to achieve PSI setting:

300-320 psi = 5 shims; 320-340 psi = 6 shims;
340-348 psi = 7 shims; 435 psi = 12 shims

Parts List

Kits

Table 15.0 End Cover Bearing Shim Kit (Item 41)

Models 3322/3922/4622

Kit No. 990715-000

PART NO.	QTY.	DESCRIPTION
107744-003	1	Bearing Shim
107744-005	1	Bearing Shim
107744-010	1	Bearing Shim
107744-015	1	Bearing Shim
107744-020	1	Bearing Shim
107744-030	1	Bearing Shim

Models 5422/6422

Kit No. 990388-000

PART NO.	QTY.	DESCRIPTION
103798-003	1	Bearing Shim
103798-005	1	Bearing Shim
103798-010	1	Bearing Shim
103798-015	1	Bearing Shim
103798-020	1	Bearing Shim
103798-030	1	Bearing Shim

Table 16.0 Shaft Seal Kits (Item 116)

Models 3322/3922/4622

Seal Kit No. 990709-000

PART NO.	QTY.	DESCRIPTION
108395-000	1	Drive Shaft Seal
101680-250	1	Retaining Ring
107836-000	1	Spacer

Models 5422/6422

Seal Kit No. 990753-000

PART NO.	QTY.	DESCRIPTION
110192-000	1	Drive Shaft Seal
101680-250	1	Retaining Ring
107836-000	1	Spacer

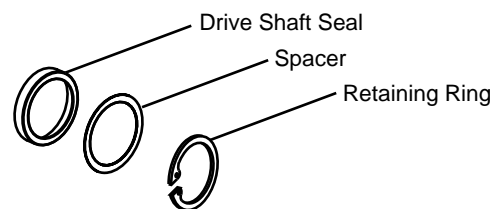

Table 17.0 Magnetic Speed Sensor Kit (Item 85)

Magnetic Speed Sensor

Kit No. 990745-000

PART NO.	QTY.	DESCRIPTION
4997282-001	1	Magnetic Speed Sensor
16160-125	1	Retaining Ring
8761-016	1	O-Ring
108307-000	1	Plug

Speed Sensor Mating Connector Kit

Kit No. 990766-000

PART	QTY.	DELPHI PACKARD P/N
Connector	1	1216-2193
Terminal	2	1212-4075

Recommended wire size: 16 - 18 AWG
 Recommended cable diameter: 2.0 - 2.4 mm
 Alternate reference source:
 Power and Signal Group North American Headquarters
 1-800-722-5273
www.powerandsignal.com/netstore/start

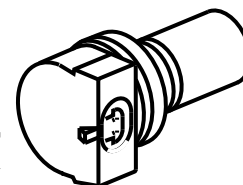

Table 18.0 Repair Gasket Kit

Kit No. 990710-000

ITEM	PART NO.	QTY.	DESCRIPTION
5	108480-000	1	End Cover Gasket (Models 33/39/46)
5	108974-000	1	End Cover Gasket (Models 54/64)
7	110003-000	1	EP Control Gasket
7	108992-000	1	Manual Control Gasket
7	108879-000	1	Solenoid Control Gasket
15 B	8761-042	2	O-Ring A Pad(cust)
15 B	8761-045	2	O-Ring B-Pad(cust)
15 B	8761-158	1	O-Ring C-Pad(cust)
15 C	8761-157	1	O-Ring Pad (charge cover)
15 C	8761-158	1	O-Ring Pad (charge cover)
15-2	103223-000	4	Sealing Washer
15-4	8761-156	1	Charge Cover O-Ring

ITEM	PART NO.	QTY.	DESCRIPTION
15-4	8761-157	1	Charge Cover O-Ring
26	16254-8	1	Thread Seal
27	8761-144	2	O-Ring (Models 33/39/46)
27	8761-157	2	O-Ring (Models 54/64)
28	108300-000	2	Ring Seal (Models 33/39/46)
	108915-000	2	Ring Seal (Models 54/64)
32	8761-139	2	O-Ring (Models 33/39/46)
	8761-145	2	O-Ring (Models 54/64)
49	8785-012	2	O-Ring
57	110457-000	4	Static Face Seal
59	8761-017	2	O-Ring
60	108562-000	2	Back-up Ring
87	8761-016	1	Speed Sensor O-Ring
91	107762-000	1	Swashplate Gasket
93	8761-010	1	Swashplate O-Ring

Disassembly

The following repair information may be used in the inspection, conversion and repair of the Eaton Series 2 Heavy-Duty Variable Displacement Pump. The manual displacement control, electronic proportional (EP) control, high pressure relief valves, pressure override valves and the auxiliary pump options are covered.

These procedures cover the basic series 2 pump. The Eaton Series 2 is available in two frame sizes with various displacements and options. The procedures for the pumps with options that are not shown are basically the same.

Work in a clean area, as the level of cleanliness maintained when repairing the pump may affect pump

performance. After washing the parts with clean solvent, blow the parts dry with air. Inspect all mating surfaces. Replace all damaged parts. Do not use grit paper, files or grinders on finished parts.

Whenever a pump is disassembled, it is preferable to replace all seals. Lubricate new seals with petroleum jelly before installation. Use only clean, recommended hydraulic fluid on finished surfaces before reassembly.

Thoroughly clean the exterior of the pump before disassembly. Make sure all open ports are sealed.

CAUTION: Disconnect or disable all electrical or mechanical power to the pump before beginning work.

Control Subassembly Removal

1. Remove the control valve. If your pump has a manual control, solenoid activated control, or hydraulic remote control, proceed to step 3. If your pump has an optional Electronic Proportional (EP) control, follow steps 4 through 8.

2. Remove the five retaining cap screws using a 1/4 in. bit socket or hex key. Remove the control sub-assembly by lifting it straight up. Go to step 9.

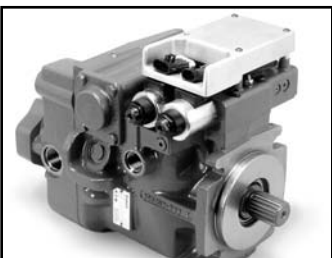
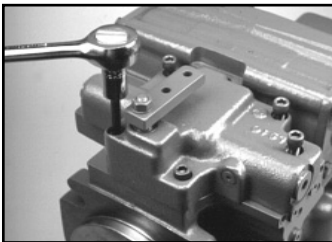

CAUTION: Handle electronic equipment with care.

3. For pumps with an optional EP control, disconnect all power to the input device. Release the latches and disconnect the connectors between the electronics module and the command input device.



4. Using a 1/8" bit socket or hex key, remove the three button head cap screws and lock-washers. Carefully lift the electronic module off the control.

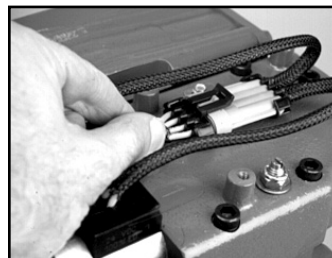

5. Unlatch and disconnect the connector between the electronic module and the solenoid coils.

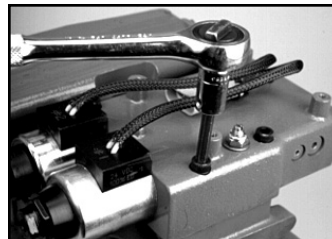

6. Using a 1/4" hex key or 1/2" socket/end wrench, remove the five hex head cap screws.

Disassembly



- Lift the valve assembly straight up and away from the pump. Take care not to damage the feedback link or swashplate link. The swashplate link must remain seated on the swashplate pin.

Continue with step 9.



- Remove the control valve gasket and discard.



- Remove the control valve feedback sub-assembly by lifting it straight up.

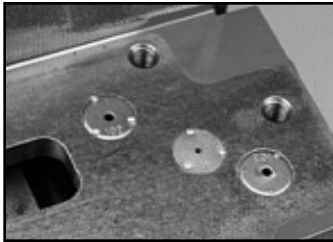

- ONLY** remove orifices if orifice size needs to be changed. The type of control and application determine orifice size and location. Orifice sizes are stamped on the face of each orifice. Orifices are staked to retain them in their pockets.



- Using a 9/16" hex key or allen wrench, remove the two high pressure relief valves or check valve sub-assemblies.



- Using a 9/16" hex key or allen wrench, remove the socket head plug. This plug retains the clocking link, that is removed later (Step 44).



- a. Remove the lower clocking link retaining plug. Use a 5/8 allen wrench.



Note: Depending on the configuration, the pump will have either high pressure relief valves or check valve subassemblies. High pressure relief valve settings are marked on the end of each relief valve subassembly. When high pressure relief valves are used, the valve located in the low pressure side of the closed circuit acts as the inlet check valve.



- If the pump has optional internal pressure override valve plugs, use a 12 mm hex key or allen wrench to remove the two plugs, springs and spring end.

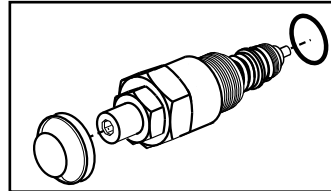

Externally Adjustable POR Valve

Note: The pressure override valve come in two configurations, Shim adjustable and externally adjustable. To preserve factory settings, do not mix "Pressure Override" parts from one valve to another.



Shim Adjusted POR Valve

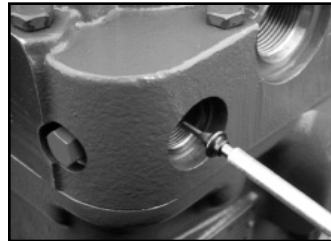

- Using a pair of needle nose pliers remove the valve poppet.

Disassembly

Charge Relief Valve Removal

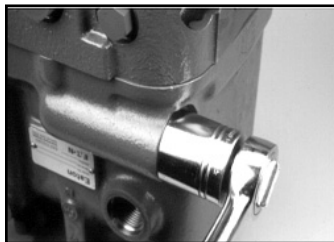

14. Using a 1-1/4 in. socket or end wrench, remove the charge pressure relief valve from the pump housing.

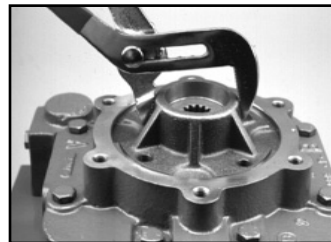

18. Using a large pair of adjustable pliers remove the charge pump cover. Gently rock the cover back and forth as you pull upward.

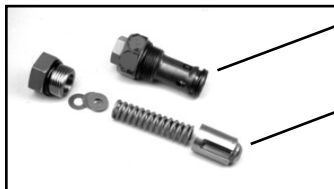

Current production version

Obsolete Relief Valve Design

Note: The current version charge relief is a factory set cartridge design pressure setting. This is stamped on the valve. This version consists of a cap, spring and poppet.

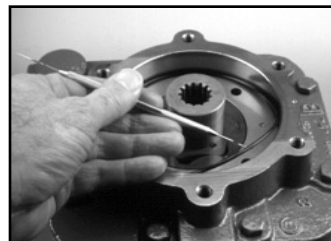

19. Remove the sealing O-ring for the charge pump cover from the end cover.

Charge Pump & Auxiliary Pad Removal



15. Using a 5/16 in. hex key or allen wrench, remove the cap screws from the auxiliary pump adapter flange. Remove the mounting flange from the pump end cover.



20. Remove the charge pump coupling and gerotor star.

Note: The gerotor star is a slip fit on the coupling and is driven by a small key. Use caution not to lose the key. Slide the star from the coupling. It is not necessary to remove the retaining ring from the coupling.



16. Turn the auxiliary pump adapter over and using an O-Ring pick or similar tool, remove the sealing ring.



21. Remove the gerotor outer ring from the eccentric ring located in the end cover.

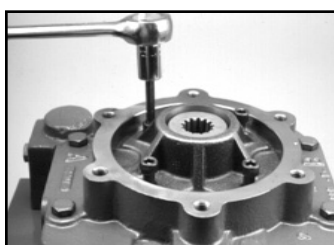

17. Using a 1/4 bit socket or hex key, remove the cap screws for the charge pump cover.

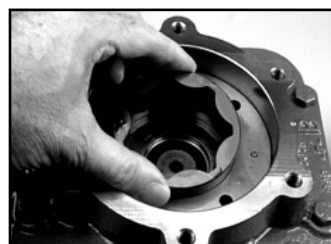

22. Remove the eccentric ring. Note position of the eccentric ring for reassembly. Eccentric ring position in the end cover is used to determine charge pump input rotation.

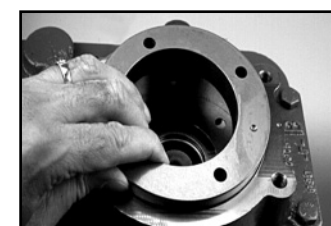

Disassembly

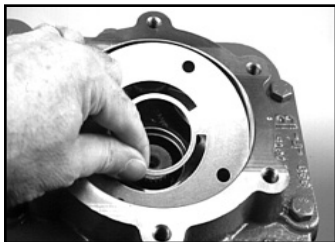

23. Remove the charge pump valve plate. Note the valve plate position as it is also used to determine charge pump input rotation.

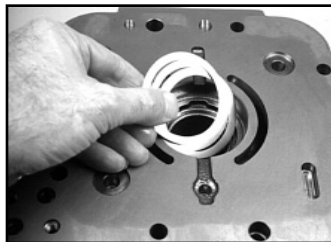

27. Remove the rear bearing shims from the end cover. Do not discard shims as they will be re-used.

End Cover Removal

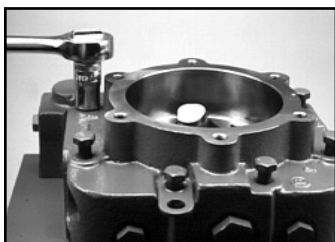

24. Remove the end cover retaining cap screws. Use caution as the end cover has an internal preload. If the end cover doesn't rise when the cap screws are loosened, you may have to tap the end cover to break the gasket seal.

Carefully remove the end cover. Do not drop any internal parts such as the valve plate, bearing cup, etc. which may stick to the end cover. Use caution when handling all close tolerance parts.

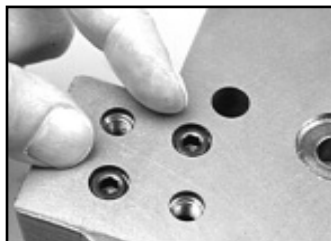

Note: ONLY remove the pressure override passage plugs if you intend to change the pump rotation.

Proper orientation in end cover is shown for each direction of rotation below.

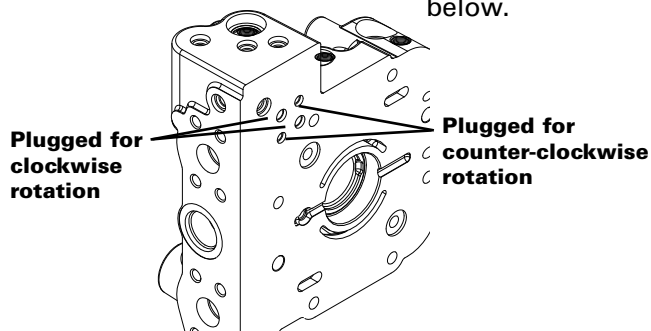

Passage plugs in housing must also be swapped whenever direction of rotation is changed.

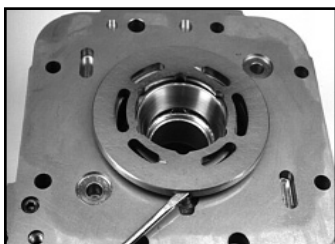

25. Carefully turn the end cover over and remove the valve plate and dowel pin.

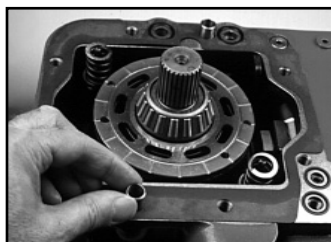

29. Remove the two hollow dowels from the pump housing.

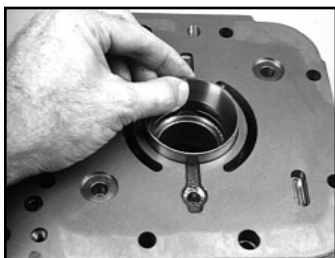

26. Remove the rear bearing cup from the end cover. The bearing cup is a slip fit into the end cover.



30. Using an O-ring pick or similar tool, remove the sealing O-rings and backup rings from the pump housing.

Note: Only pumps with the internal pressure override option have the additional O-rings and backup rings shown.

Disassembly

Rotating Group Removal

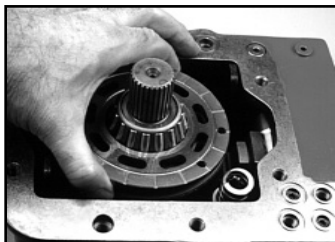

31. Remove the bearing plate and two dowel pins from the cylinder barrel.

Note: If using a small screwdriver or similar tool to pry the bearing plate from the cylinder barrel, be careful not to scratch or damage the lapped surfaces of the cylinder barrel or bearing plate.



Shown are the valve plate (left) and bi-metal bearing plate (right). Bearing plates are bi-directional and valve plates are uni-directional.

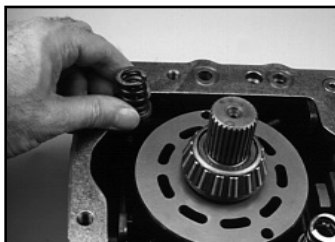

32. Remove the hold-down springs and washers.

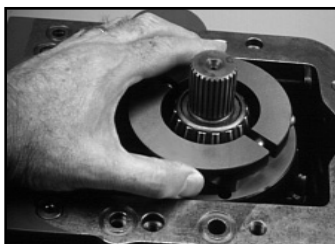

33. Install a low clearance, split-type bearing puller under the rear bearing.

Note: See the special tool section for dimensions required to make a low clearance bearing puller.

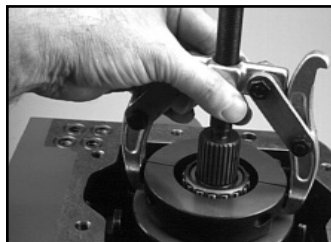

34. Install the puller on the bearing puller. **DO NOT REMOVE THE BEARING AT THIS TIME.** Use the puller handle to remove the pump drive shaft, swashplate and rotating group from the pump housing.

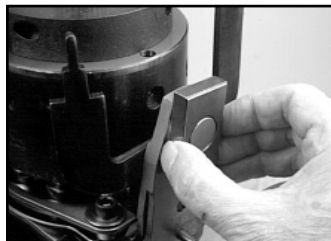

35. Properly support the rotating group using a ridge mounted shaft coupling or soft jaw device to secure the input end of drive shaft inverted position. Remove the slide block from the swashplate.

! CAUTION: Do not damage bearing or sealing surfaces

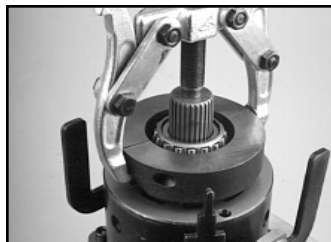

36. Remove the rear bearing by using the bearing puller that was previously installed.



37. Carefully slide the swashplate and rotating group up and over the pump shaft subassembly.

Disassembly

Rotating Group Disassembly



38. Remove the pump drive shaft subassembly from cylinder barrel.

Note: When it is necessary to replace the front bearing, use a hydraulic press to remove the bearing from the shaft. Replacement bearings are pressed to a specific dimension and are listed on page 56 (Main Shaft Bearing Stop Limit Tool).



39. Position the swashplate and rotating group back on the support base. Using a 1/4 in. allen wrench or bit socket, remove the screws, spacers and strap from one side of the swashplate. Loosen, but do not remove, the other side.



41. Place the swashplate and rotating group on a clean, flat surface. Using a 1/4 in. allen wrench or bit socket, remove the loosened screws, and carefully remove the swashplate from the rotating group.



42. Remove the piston subassemblies and piston retainer. Place them on a clean, protective surface for inspection and cleaning.

Swashplate Bearing Removal

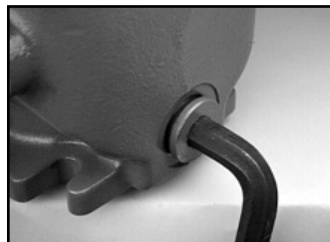

43. Using a 5/8 in. allen wrench or bit socket, remove the locking link retaining plug.



44. Remove the two swashplate bearings and locking links.



45. Remove the two bearing races from the pump housing.



47. Remove the shaft seal by using a large screwdriver or similar tool to drive the seal from the housing.



48. Remove the front bearing race. It may be a slip- or press-fit in the housing.

Disassembly

Servo Piston Removal

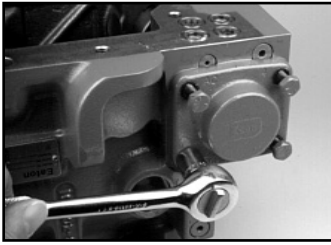

49. Using a 1/2 in. end wrench or socket, remove the retaining cap screws from the servo piston cover.

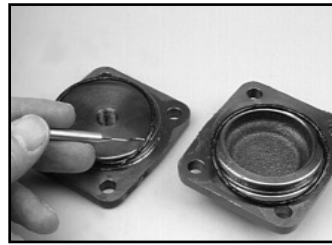

53. Using an O-ring pick or similar tool, remove the seals from the underside of both servo covers.

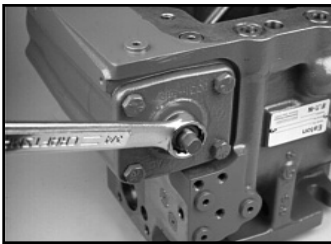

50. Using a 3/4 in. end wrench, remove the servo adjustment screw lock nut and special beveled washer from the adjustable side servo piston cover.

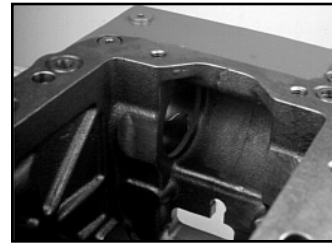

54. Using an O-ring pick or similar tool, remove the two servo piston seals from the pump housing.

Note: Use caution not to scratch or damage the servo piston bore.

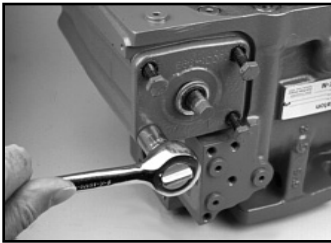

51. Using a 1/2 in. end wrench or socket, remove the retaining cap screws and remove the servo piston cover from the pump housing.

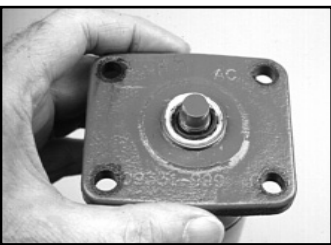

52. Unscrew the cover from the servo piston adjustment screw.

Assembly

***Note:** Before re-assembly, clean all parts and sub-assemblies. Inspect and replace damaged parts and subassemblies. When reworking parts, do not use coarse grit paper, files or grinders on finished surfaces. Replace all gaskets and seals. Lubricate all seals with petroleum jelly for retention during reassembly. Freely lubricate all bearings and finished surfaces with clean hydraulic fluid.



1. When replacement of the front bearing cup is necessary, simply place it in the pump housing.



5. Screw the lock nut on the servo piston adjustment screw. **DO NOT TIGHTEN** the lock nut at this time.

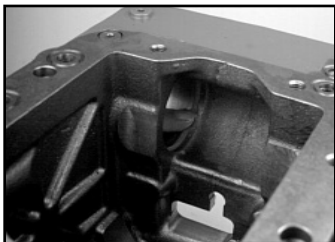

2. Lubricate and carefully install two new O-ring seals and back-up rings into the servo piston bore of the pump housing. Install the black sealing ring first, then the blue back-up ring. Be careful not to twist or kink the seals.



6. Lubricate and install the servo piston into the pump housing. Place into the side opposite the speed sensor port. The flat side of the servo piston must be perpendicular to, and facing, the center of the pump housing. Install the four servo cover retaining cap screws. Torque cap screws to 16 ft. lbs. [21,7 Nm] to 17 ft. lbs. [23 Nm].

Servo Piston Installation



3. Lubricate and install new seals on both servo piston covers.

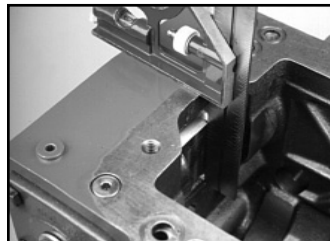

7. Using a square, check to make sure the flat side of the servo piston is perpendicular to the pump housing face.



4. Place the servo piston cover on the servo piston adjustment screw. Screw about half way down the screw. Install a new threaded seal and beveled washer. Place the threaded seal first, then the washer. The beveled side of the washer must face the seal.



8. Install the remaining servo piston cover and remaining four servo cover retaining cap screws. Torque cap screws to 16 ft. lbs. [21,7 Nm] to 17 ft. lbs. [23 Nm].

Assembly

Swashplate Bearing Installation



9. Lubricate and install the two bearing races into the pump housing on the locating pins with the grooved side of the races toward the center of the pump housing.



11b. Lubricate and reassemble the rotating group.



10. Apply a small amount of petroleum jelly on the pin pivots to help to hold them upright. Install the two locking links into the pump housing.

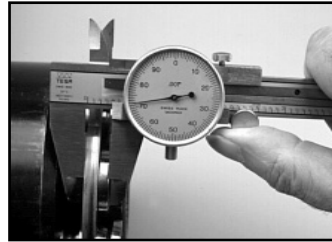

11c. Measure the combined thickness of the piston shoes and retainer (dimension B). The difference between dimension A and dimension B is the fixed clearance (dimension C).

Lubricate and install the two swashplate bearings into the pump housing by aligning the hole in the side of the bearings with clocking links.

The fixed clearance must not exceed .008 inches. Whenever the fixed clearance exceeds .008 inches, the piston/shoe assemblies should be reevaluated.

Rotating Group and Swashplate Installation

11. Before proceeding further, the fixed clearance must be checked. The preset fixed clearance is the clearance between the piston shoe face and thrust plate. The formula for this clearance is: Dimension A minus Dimension B equals Dimension C. Dimension C must not exceed .008 inches.



12. Position the swashplate on the support base. Lubricate the thrust plate and install it on the swashplate. Install the two spacers, strap, washers and retaining screws.

DO NOT tighten the two retaining screws.

IMPORTANT: The bronze side of the strap must face the swashplate.

Max. Clearance (C) .008

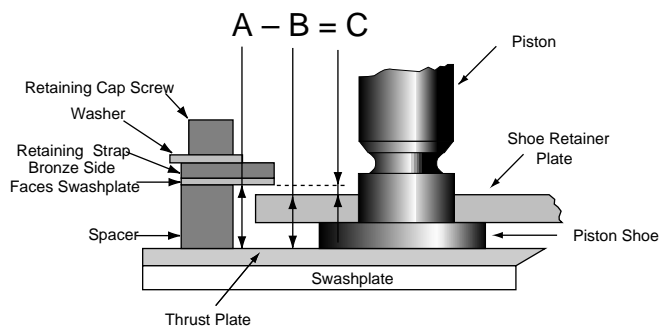

13. Carefully install the swashplate on the rotating group.



11a. Measure the height of the retaining strap spacer (dimension A) using a micrometer or dial vernier calipers.

Assembly



14. Holding the swashplate and the rotating group together, carefully install it back on the support base. Install the remaining two spacers, strap, washers and retaining screws. Torque all four retaining cap screws to 17–18 ft. lbs. [23–24,4 Nm].



19. Reinstall the bearing puller on the rear bearing so it can be used as a handle.

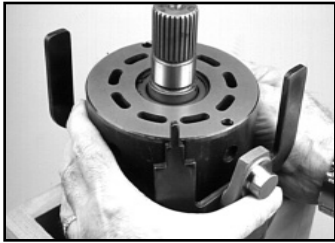

15. Lubricate and install the input drive shaft into the rotating group/swashplate subassembly.



20. Carefully lift the entire subassembly and install it into the pump housing. Align the two notches in the swashplate with the two clocking links, and the swashplate side with the notch in the servo piston.

Important: The swashplate assembly must be fully seated on the swashplate bearings.

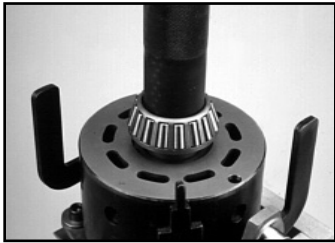

16. Lubricate and install the rear bearing on the shaft and bearing subassembly. Support the subassembly in a slightly raised position.

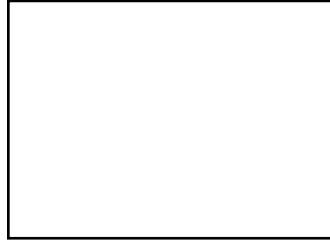

21. Install the lower clocking link retaining plug. Torque plugs to 125 ft. lbs. [169,5 Nm].

17. Using a hydraulic press, press the rear bearing cone on the shaft. The bearing cone must be firmly seated against the machined shoulder of the pump shaft. **Note:** The bearing cone may be heated for installation.

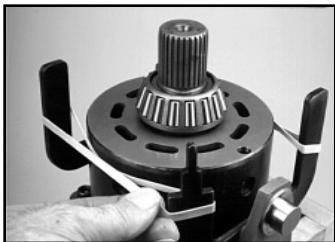

Tip: Place two heavy rubber bands across both arms to help to retain the two hold down arms.

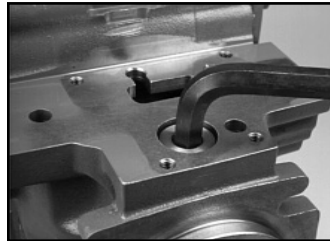

- 21a. Install the clocking link plug and torque to 125 ft. lbs. [169,5 Nm].



18. Apply a small amount of petroleum jelly to the back side of the slide to hold it in position. Lubricate and install the slide block on the swashplate.



22. Remove the bearing puller and two rubber bands from the swashplate subassembly.

Assembly

Swashplate Neutral Adjust

23. The swashplate must be set to neutral. Place a parallel bar across the face of the pump housing, making sure the bar is resting firmly on the housing face.



23a. Using a depth micrometer, measure the distance from the parallel bar to the face of the swashplate and note the dimension.



23b. Move the depth micrometer to the opposite side of the swashplate and measure the distance from the parallel bar to the face of the swashplate and note the dimension.

23c. With the two dimensions noted, turn the face of the depth micrometer so that the zero position is right in between the two noted dimensions.



23d. Use a 3/8 in. end wrench to turn the servo piston adjustment screw clockwise or counterclockwise to bring the swashplate to the zero position.

Note: Earlier units used a screwdriver slot to adjust the zero position.

Adjusting Shaft Bearing End Play and End Cover Assembly

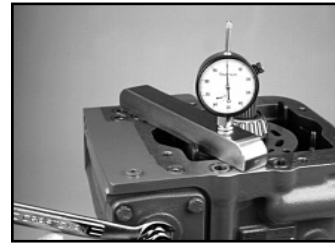

23e. Using 3/4 in. end wrench, tighten the servo adjustment screw lock nut, using caution not to disturb the neutral or zero swashplate position.

23f. Torque the lock nut to 45 ft. lbs. [61 Nm]. Remove the depth micrometer and parallel bar.

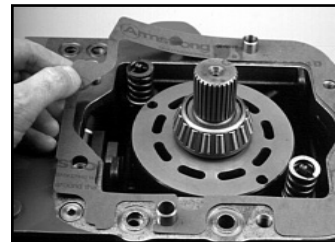

24. Install the two hollow dowel pins in the pump housing and the two hold-down springs and washers on the swashplate hold-down arms.

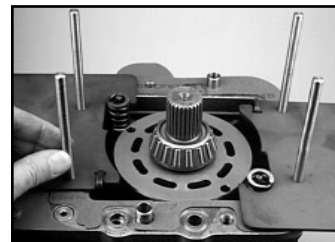

25. Install two hold-down arm assembly alignment tools and dowels.

Note: The alignment tool is a special tool. Dimensions required to make this tool are located in the Special Tool section.

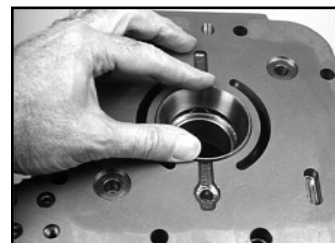

26. Lubricate and install the rear bearing shims and cup into the pump end cover.

27. Check the drive shaft end play.

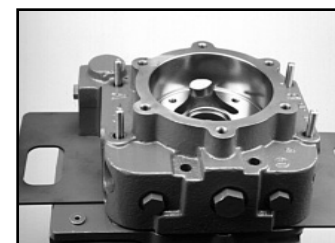

27a. Install the end cover without either the valve or bearing plates, aligning it with the alignment tool dowels.

Assembly

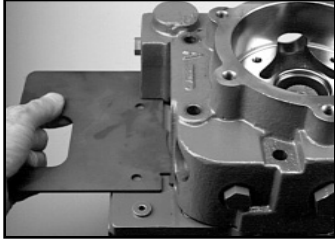

27b. Remove the four dowel pins and carefully remove the two alignment tools using caution not to disturb the housing gasket.



27f. Install a magnetic base indicator on the mounting flange with the indicator's gauge probe on the input shaft.



27c. If you are not using the special alignment tools, you must align the swashplate hold-down ears and springs with the recesses machined into the end cover face. Elevate the end cover slightly and, using a machinist ruler or similar tool, align the ears and springs with the recesses on both sides of the end cover.

27g. Using slip joint pliers, grip the drive shaft as low as possible and pry upward to determine shaft end play. The reading must be between .002 to .007 inch. To adjust shaft end play, either add or delete the shims located under the bearing cup in the end cover. When end play is correct, remove the magnetic base indicator.

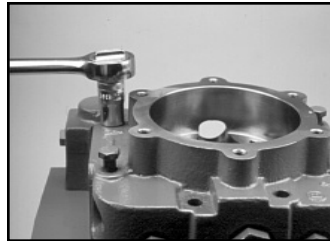

28. Reposition the pump and remove the end cover. Add or remove bearing shims as necessary



27d. Install four of the end cover retaining cap screws and tighten.

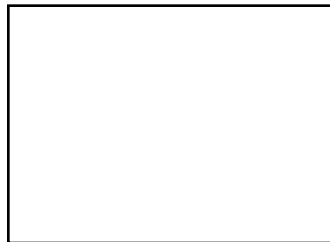

29. Lubricate and install the pump housing sealing and back-up rings.

Note: On units with the pressure override option, special tapered sealing and back-up rings are used. Correct installation is with the taper on the sealing ring facing upward and with the taper on the back-up ring facing downward.

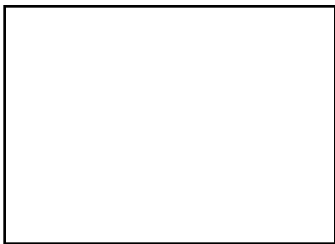

27e. Reposition and support the pump on the end cover. Use a hammer to gently tap the input shaft inward.

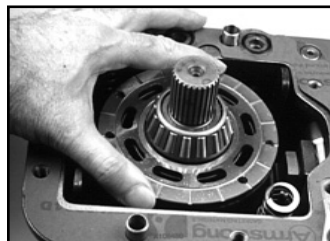

30. Install the two dowel pins in the cylinder barrel subassembly block face. Freely lubricate the bearing plate and install it on the cylinder barrel subassembly, aligning it with the dowel pins.

Assembly

Charge Pump Installation

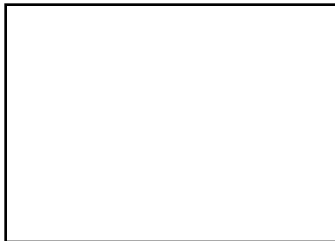

31. Note one side of the kidney slots in the charge pump valve plate is wider than the other. Note the (A) and (B) stamped on the end cover, next to the high pressure ports. The position of the charge pump valve plate determines charge pump input rotation.

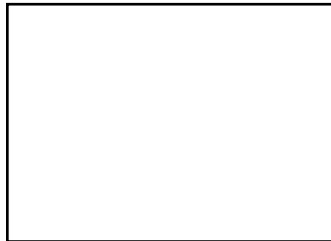

34. For pumps with clockwise input rotation, install the eccentric ring so the identification "dots" are aligned. The wide side of the eccentric ring is on the (B) side of the end cover.

For pumps with counterclockwise input rotation, install the eccentric ring so the identification "dots" are not aligned. The wide side of the eccentric ring is on the (A) side of the end cover.



32. For pumps with clockwise input rotation, install the charge pump valve plate so the wide side of the kidney slot is on the (A) side of the pump end cover.

For pumps with counterclockwise input rotation, install the plate so that the wide side of the kidney slot is on the (B) side of the pump end cover.



35. Lightly coat the charge pump drive key with petroleum jelly to help hold it in position during assembly. Install the drive key in its recess located in the charge pump coupling.

Install the gerotor star on the charge pump coupling by aligning with the drive key. Next, install the charge pump coupling subassembly and gerotor's outer ring into the pump end cover.

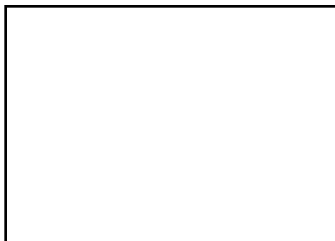

33. Note one side of the eccentric ring is wider than the other and that the wide side has an identification "dot." The eccentric ring also determines charge pump input rotation.

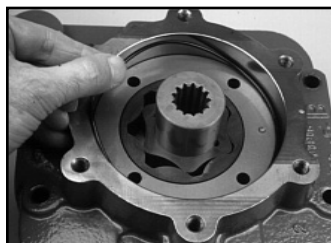

36. Lightly coat the charge pump sealing ring with petroleum jelly and install it into the end cover.

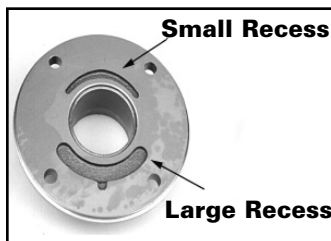

37. Note the small and large recess cast into the charge pump cover subassembly. The large recess side of the charge pump cover must face toward the charge pump inlet.

Assembly

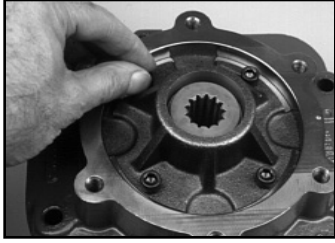

38. Install the charge pump cover over the coupling and into the pump end cover, aligning the large recess in the cover subassembly with the charge pump inlet. Install the four retaining cap screws.



42. Install the pump end cover, using the two alignment tool dowels to align the end cover.

It may be necessary to rotate the charge pump coupling slightly to align the splines before the end cover will set squarely.



39. Using a "T" handle to rotate the charge pump subassembly, torque the retaining cap screws to 20–24 ft. lbs. [27–32,5 Nm].

Note: If the charge pump assembly does not have a thru-drive, the charge pump assembly must be rotated from the other side.



If the charge pump coupling does not have a thru-shaft, the pump drive shaft may have to be rotated slightly to align the splines.

End Cover Installation

*Note: Special tools Required (see Page 5)

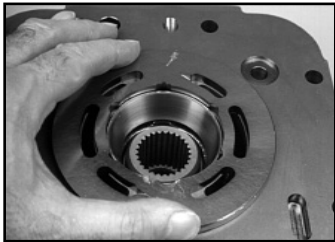

40. Install the dowel pin in the end cover. Lightly coat the end cover side of the valve plate with petroleum jelly to hold in place. Install the valve plate over the bearing cup, aligning it with the dowel pin.

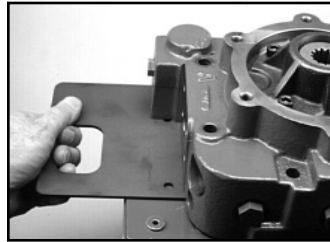

43. Check alignment of the charge pump coupling and pump shaft splines. Make sure the the swash-plate hold down arms and springs are aligned with the recesses machined into the face of the end cover.

Remove the four dowel pins. Carefully remove the two alignment tools using caution not to disturb the housing gasket and sealing rings.

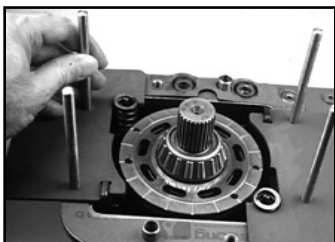

41. If you are using the special hold-down arm assembly alignment tool, install them and the dowels on the pump housing.

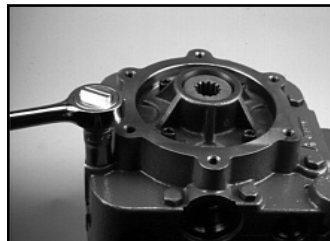

44. Install the end cover retaining cap screws.

For **models 3322, 3922 and 4622** torque cap screws to 35–40 ft. lbs. [54–47,4 Nm].

On **models 5422 and 6422** torque the cap screws to 60–65 ft. lbs. [81,3–88,1 Nm].

Assembly

Auxiliary Pad Installation

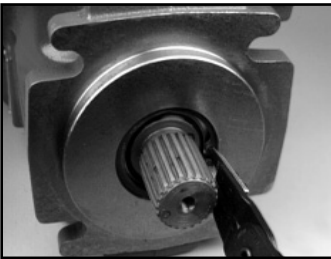
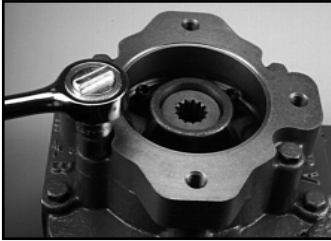
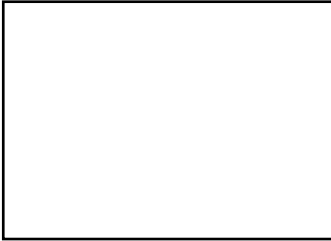

45. Lubricate and install the seal ring on the auxiliary pump mounting flange.
46. Install the auxiliary pump mounting flange on the end cover, aligning the retaining cap screw holes. Install the retaining cap screws and torque to 20–24 ft. lbs. [27,1–32,5 Nm].
46. Remove the input shaft retaining ring. Use a pair of internal retaining ring pliers with .090 straight tips and carefully remove the retaining ring and spacer ring(s). It will be easier to remove the actual shaft seal later on during disassembly.

Pressure Override and High Pressure Relief Valve Installation

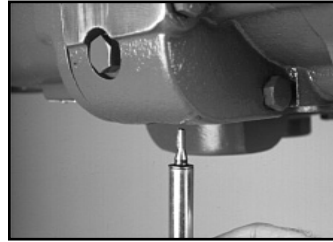

47. Lubricate and install the internal pressure override valve poppet into the pump housing using a small deep-wall socket or similar tool.
Note: It works best to install the poppet vertically into the housing.
48. Install the valve plug, shims, and valve spring end.
Note: It works best to install the parts vertically into the pump housing as there will be less chance of the parts falling out of position.
49. Torque plug to 100–105 ft. lbs. [135,6–142,3 Nm].
50. Install the high pressure valves or check valve assemblies. Torque to 120–130 ft. lbs. [162,7–176,2 Nm].

Assembly



51. Install charge relief valve.
Torque plug to 120 ft. lbs. [162,7 Nm] to 130 ft. lbs. [176,2 Nm].

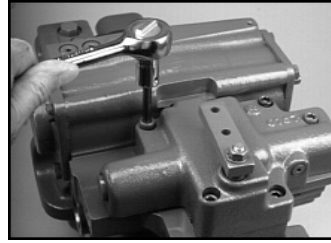

58. Install the control valve assembly on the pump housing, aligning the control valve subassembly with the feedback link.

Install the retaining cap screws and torque to 20 ft. lbs. [27,1 Nm] to 24 ft. lbs. [32,5 Nm].

Proceed to step 66.



Control Installation



52. Lubricate and install the control feedback subassembly on the swashplate sub-assembly.



59. For units with an optional EP control valve, carefully align the valve assembly to the pump housing. Align the hole in the control feedback link with the swashplate link.

Carefully lower the valve assembly straight down onto the pump, guiding the control feedback link onto the swashplate link. The feedback link must engage the swashplate link.



53. Install the control valve gasket on the pump housing, aligning with the screw holes.



60. Using a 1/4" hex key or 1/2" socket/end wrench, tighten the five hex head cap screws. Torque to 22±2 lbf-ft [29.83±2.7Nm]

57. Install the control valve. If your unit has a manual control, solenoid activated control, or hydraulic remote control, continue to step 58. If your unit has an optional Electronic Proportional (EP) control valve, follow steps 59 through 65.

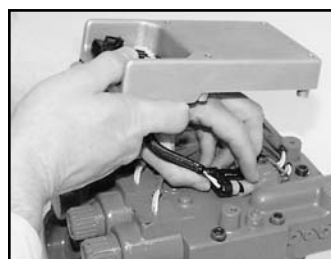

61. Connect the electronic module and the solenoid coils. The connectors must be latched securely.

Assembly

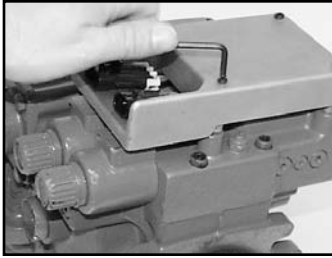

62. Carefully position the electronic module. Tuck all cables under the module. Avoid pinching cables at mounting points.

Install the three lockwashers and three button head cap screws. Torque the to 40-48 lbf-in[4,5-5.4 Nm].



68. Install the spacer washer on top of the seal.

When severe wear in the seal area of the shaft is noted, you may want to add an additional spacer washer(s) to relocate the seal. A maximum of two spacers may be used.

63. Connect the command input device to the electronic module.

64. Connect the electrical power source to the connector on the control electronic module.

Continue with step 66.

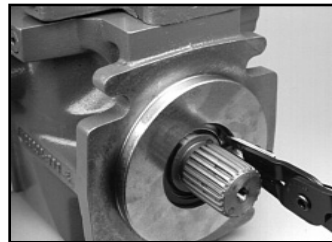

69. Install the retaining ring into the pump housing using internal retaining ring pliers.

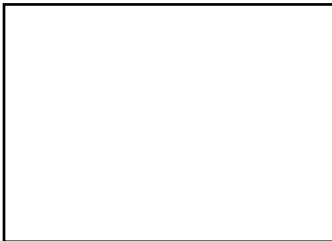

66. Install the seal into the pump housing, protecting the shaft seal with a seal bullet or similar tool. Install the seal with the lip of the seal facing inward. (See Tools on page 56.)



70. Tap the retaining ring inward until it snaps firmly in its groove using a seal driver or similar tool.



67. Drive the seal into the pump housing using a seal driver or similar tool. Drive the seal in just far enough to install the spacer washer and retaining ring.



The Series 2 Variable Displacement Pump is now ready for test and installation.

Troubleshooting

This section provides the information necessary to troubleshoot a typical hydrostatic system using an Eaton Series 2 hydrostatic pump. Using this section will help you to diagnose any minor problems that may occur. Maintaining cleanliness while you work will prevent contamination of the hydrostatic system and insure continuous and satisfactory transmission life.

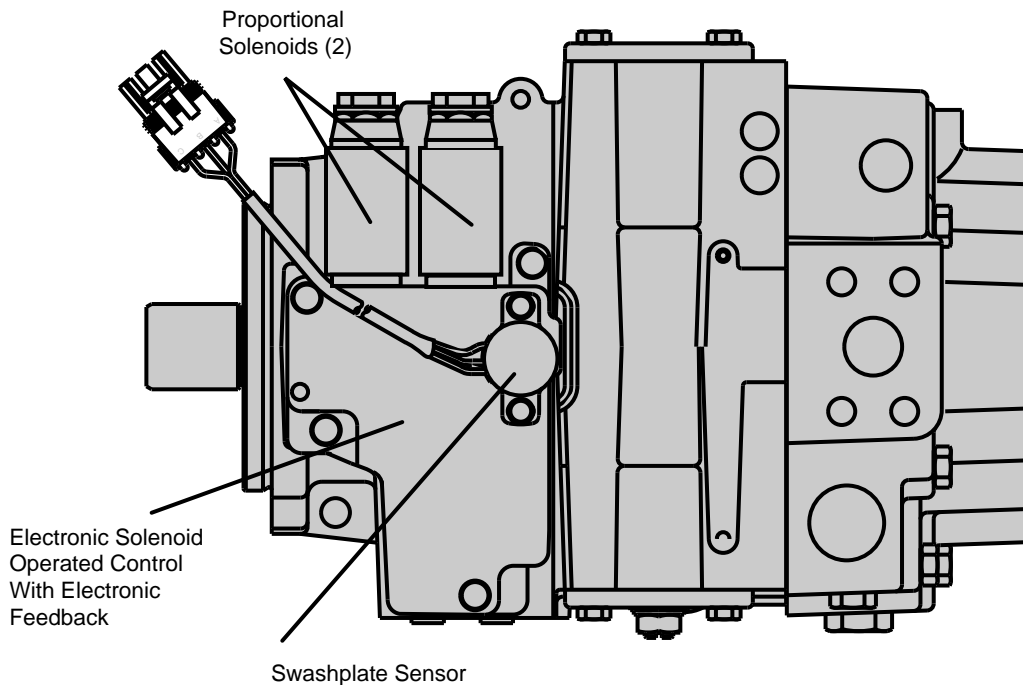
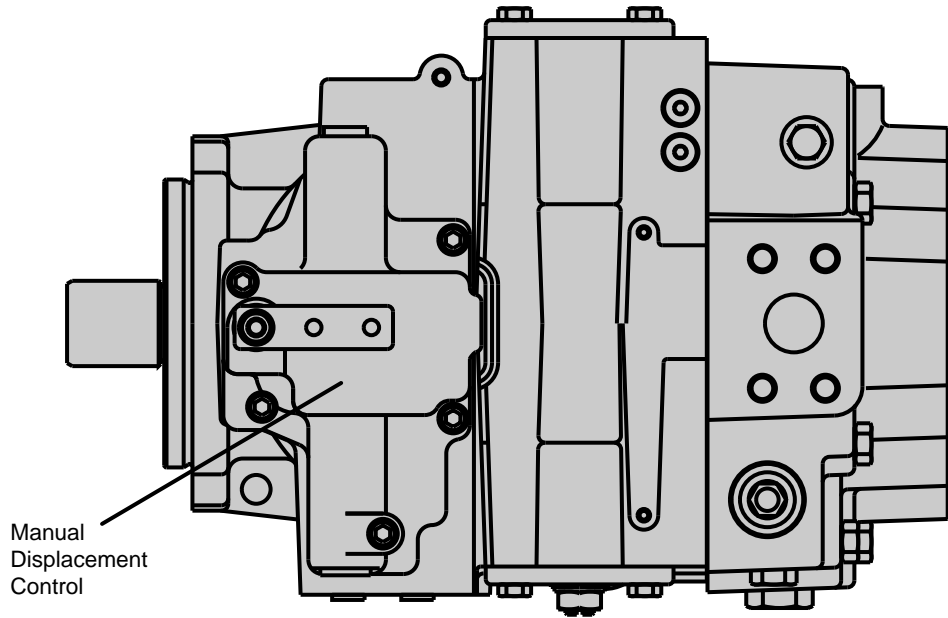

Troubleshooting

Valve/Test Port Locations

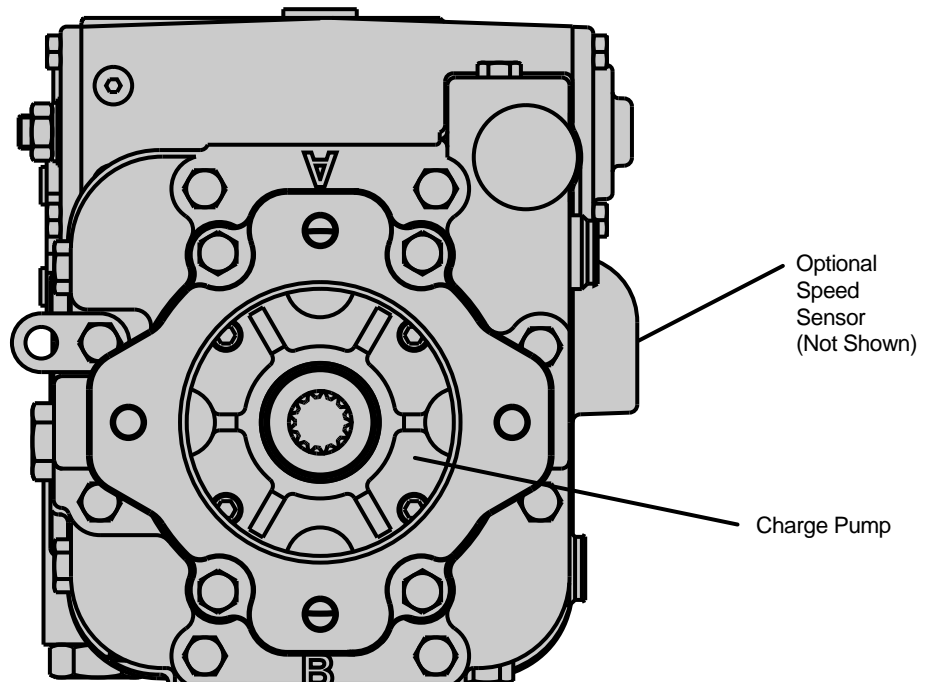
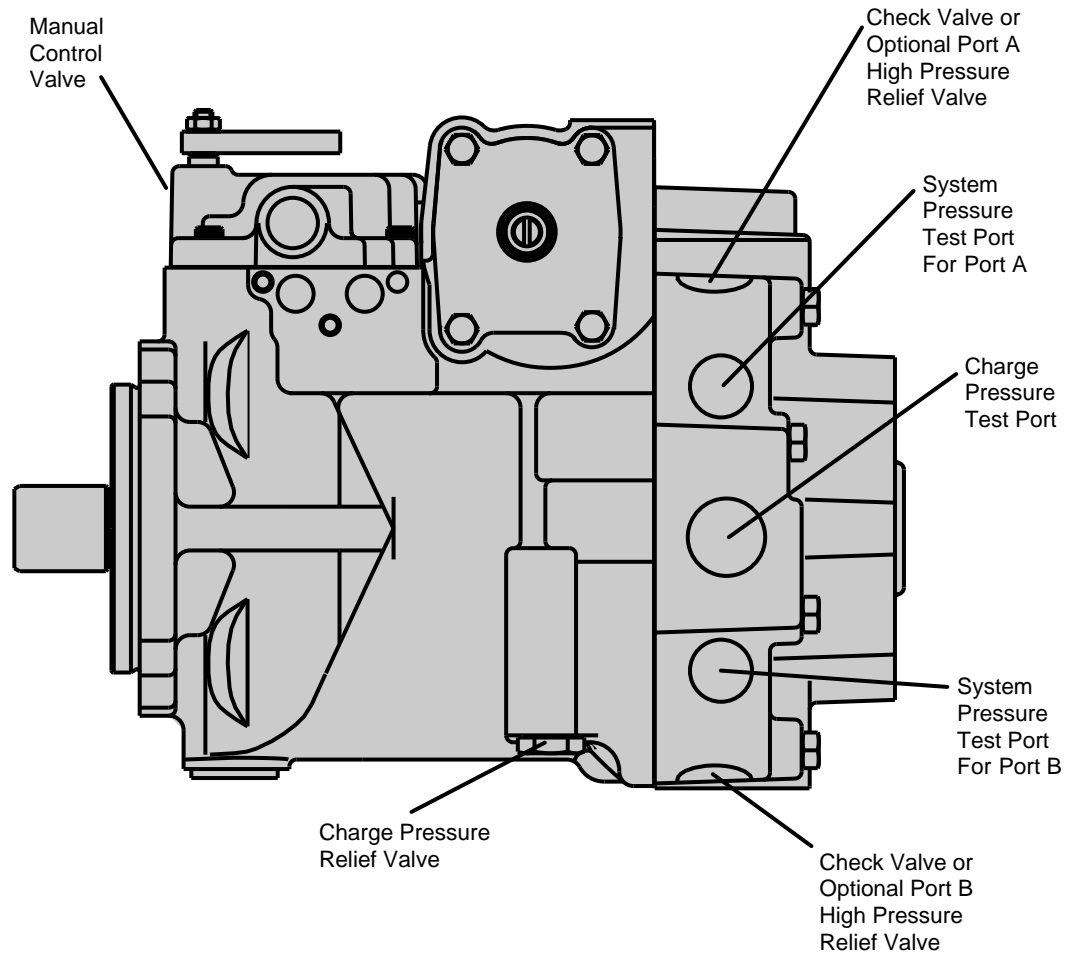

Troubleshooting

Gauge Requirements, Gauge Port Size and Locations

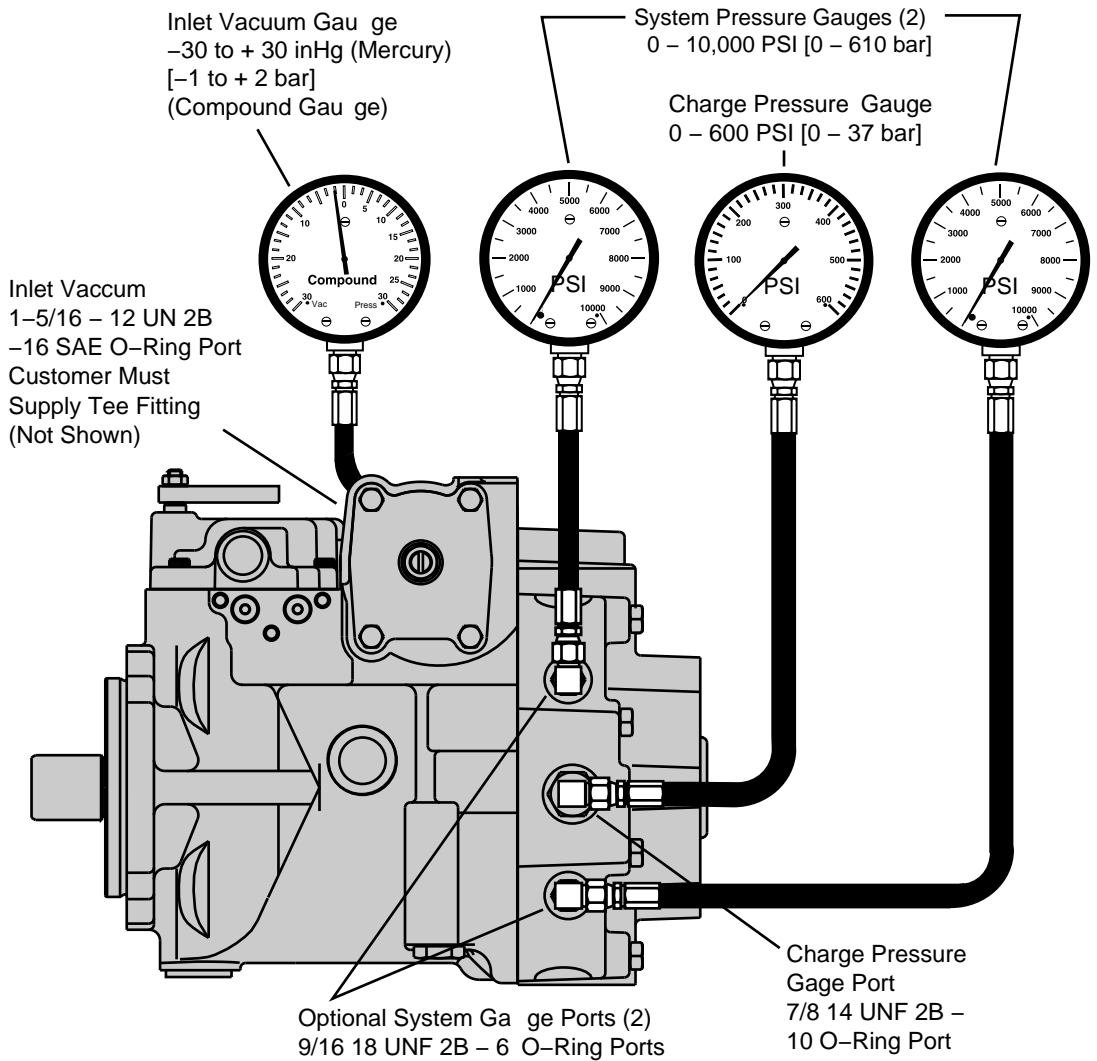

Pressure Readings

The pressures given in this manual are gauge pressures or delta pressures. A pressure gauge reads zero when connected to atmospheric pressure. Any reading above or below this zero point is referred to as gauge pressure (PSI). Delta pressure is the difference of two gauge pressures in a hydraulic circuit.

For example:

	Charge pressure reading of 340	PSI [23,4 bar]
Minus	Case pressure reading of 20	PSI [1,5 bar]
Equals	Differential Pressure of 360 D PSI [23,4 bar]	

Typical hydrostatic circuits usually include inlet pressure, case pressure, low or charge pressure and system or high pressure. These pressures will vary per each individual application and operating conditions.

Nominal Operating Pressures (at Normal Operating Temperature)

Inlet Vacuum:	Should not exceed 10 in. Hg. [254 mm Hg] (inches of mercury) for an extended period of time				
Case pressure:	Should not exceed 40 PSI [2,8 bar] for an extended period of time				
Charge Pressure:*	<table style="width: 100%;"> <tr> <td style="width: 50%;">Neutral</td> <td>340 PSI [23,4 bar]</td> </tr> <tr> <td>Forward or Reverse</td> <td>280 PSI [19,3 bar]</td> </tr> </table>	Neutral	340 PSI [23,4 bar]	Forward or Reverse	280 PSI [19,3 bar]
Neutral	340 PSI [23,4 bar]				
Forward or Reverse	280 PSI [19,3 bar]				

*Charge pressure relief valves are factory preset to their nominal setting with a 2 GPM [7,6 l/min] flow rate. The original valve pressure will increase approximately 3 PSI [0,21 bar] per 1 GPM [3,8 l/min] additional flow over the valve. The charge pressures given above are typical. Higher charge pressures may be set at the factory for your particular application.

Troubleshooting

Fault-Logic Tables

This Fault-Logic Trouble Shooting Guide is designed as a diagnostic aid in locating possible transmission problems by the user. Match the transmission symptoms with the problem statements and follow the action steps shown in the box diagrams. This will give expedient aid in correcting minor problems, eliminating unnecessary machine down time.

Following the fault-logic diagrams are diagram action comments to further help explain the action steps shown in the diagrams.

Where applicable, the action comment number of the statement appears in the action block of the diagram.

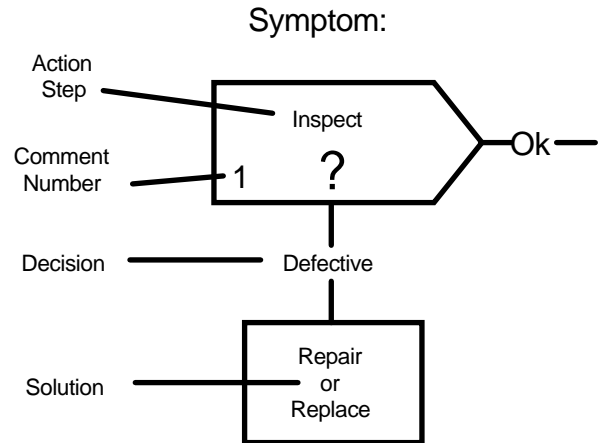

Neutral Difficult or Impossible

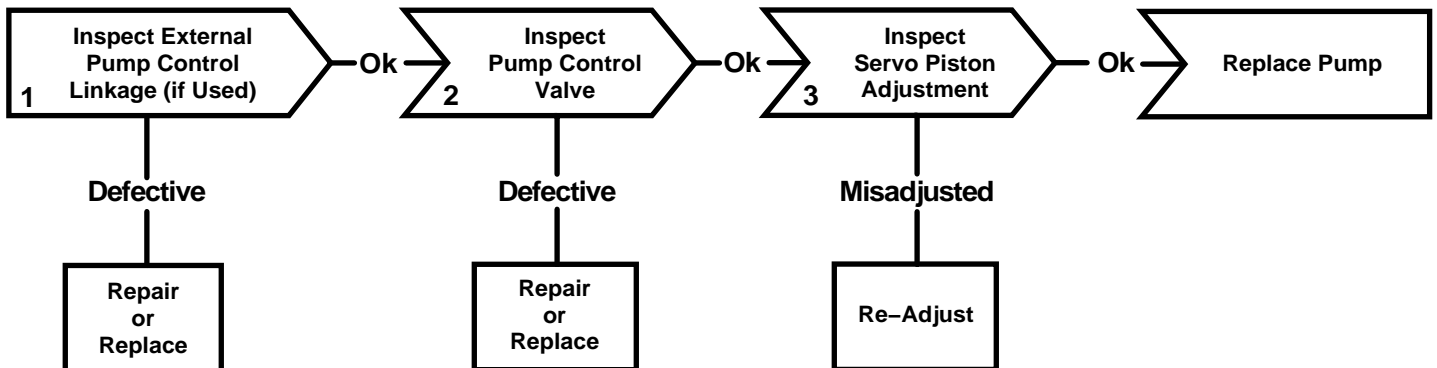

Troubleshooting

Fault-Logic Tables

Transmission Operates in One Direction Only

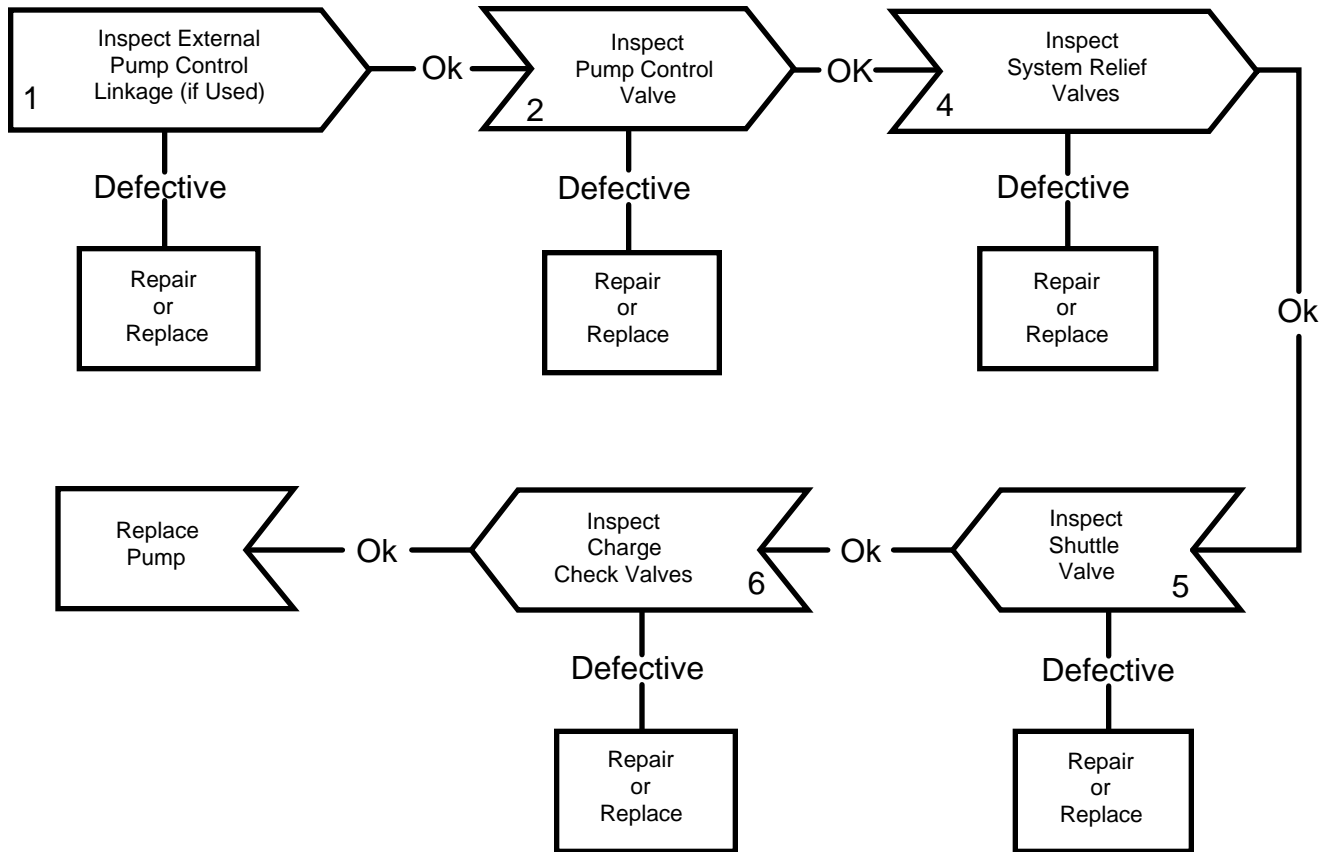

Troubleshooting

Fault-Logic Tables

System Response Sluggish

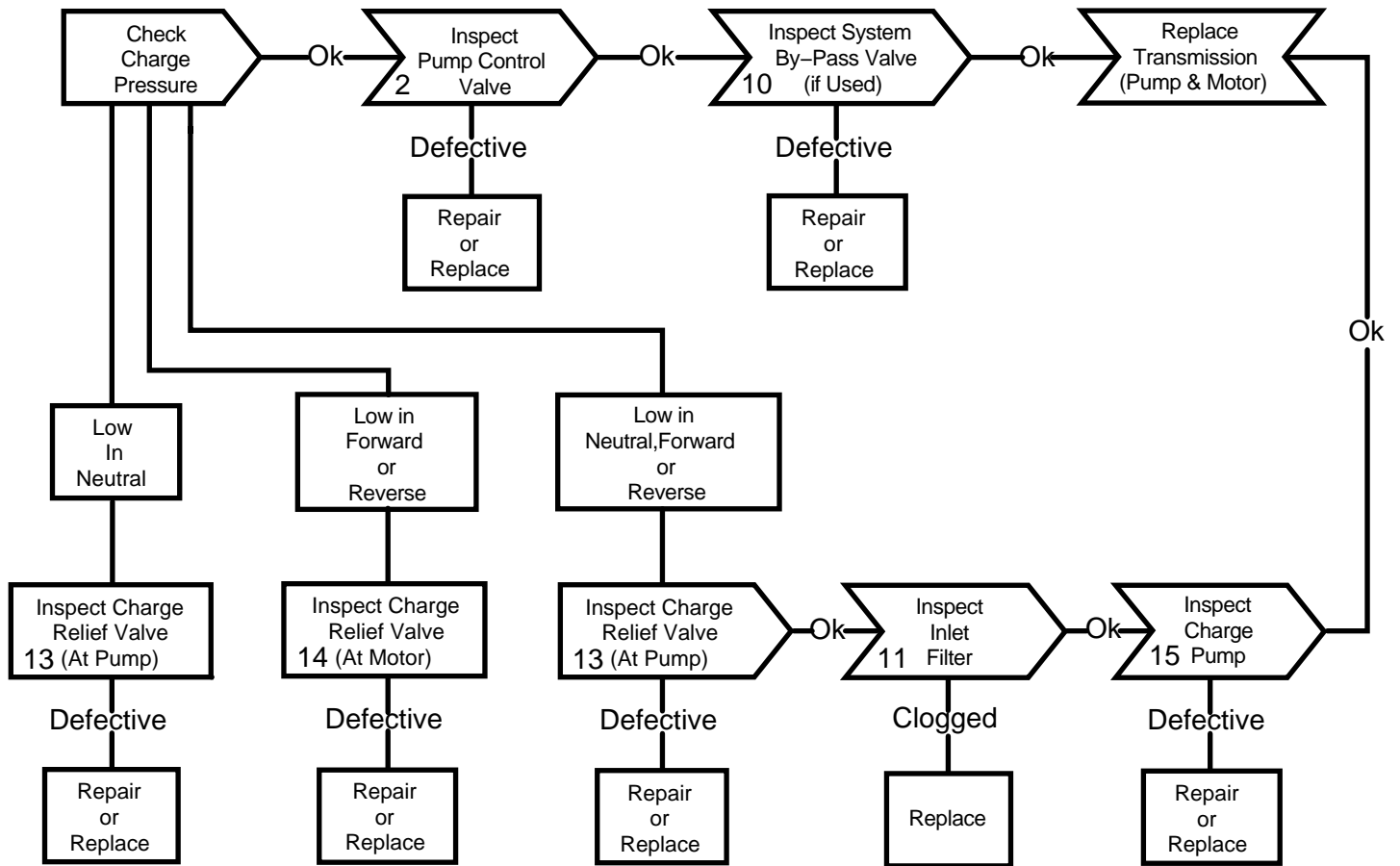

Troubleshooting

Fault-Logic Tables

System Will Not Operate in Either Direction

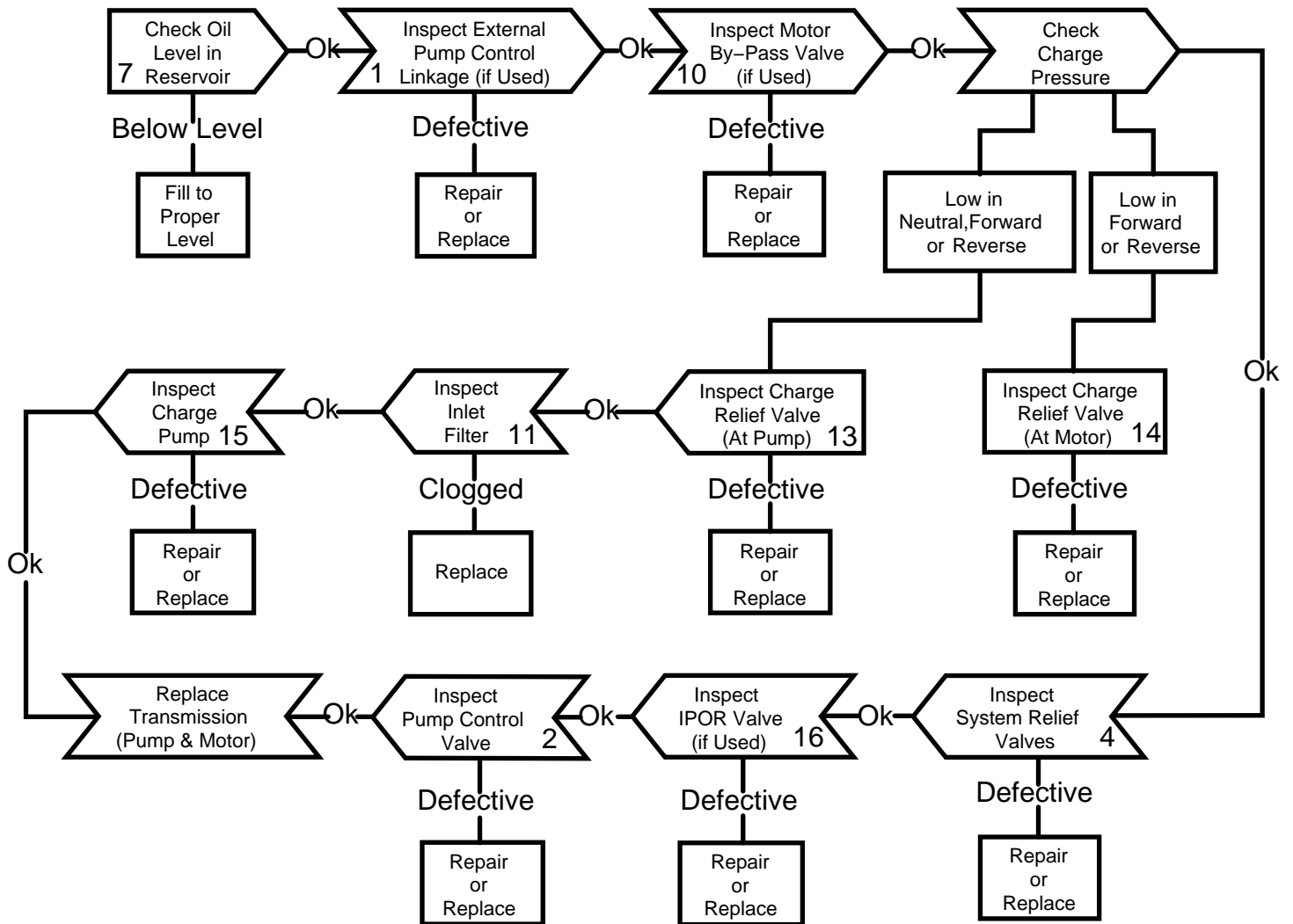

Troubleshooting

Tips

1. Inspect External Pump Control Linkage for:
 - Manual Operated Controls**
 - A. Mis-adjusted or disconnected
 - B. Binding, bend or broken
 - Hydraulic Remote Controls**
 - A. Improper pilot pressure
 - B. Defective proportional valve (see proportional valve manual)
 - Electrical Operated Controls**
 - A. Disconnected electric signal connection
2. Inspect Pump Control Valve for:
 - Manual Operated Controls**
 - A. Plugged control orifice
 - B. Damaged mounting gasket
 - C. Mis-adjusted, damaged or broken neutral return spring
 - D. Broken control connector pin
 - E. Broken or missing control linkage pin(s)
 - F. Worn, struck or bent control spool
 - Hydraulic Remote Controls**
 - A. Plugged control orifice
 - B. Damaged mounting gasket
 - C. Mis-adjusted, damaged or broken neutral return spring
 - D. Broken control connector pin
 - E. Broken or missing control linkage pin(s)
 - F. Worn, struck or bent control spool
 - G. Worn, or stuck hydraulic control pistons
 - Electrical Operated Controls**
 - A. Plugged control orifice
 - B. Damaged mounting gasket
 - C. Worn, stuck or bent control spool
 - D. Stuck solenoid valve(s)
 - E. Defective solenoid coil(s)
 - F. Mis-adjusted Potentiometer
 - G. Defective Potentiometer
 - H. Mis-adjusted speed sensor (on motor when used)
 - I. Defective speed sensor
 - J. Defective electronics module
3. Inspect Servo Piston for:
 - A. Improper servo piston adjustment
4. Inspect System Relief Valves for:
 - A. Improper pressure relief setting (consult owners/operator manual for system relief valve settings)
 - B. Valve poppet held off seat
 - C. Broken valve springs (2)
 - D. Broken valve stem
5. Inspect Shuttle Valve for:
 - A. Bent or broken return centering spring
 - B. Worn or stuck shuttle spool
 - C. Bent or broken shuttle spool
6. Inspect Charge Check Valves for:
 - A. Valve held off seat
 - B. Broken valve spring
7. Check Oil Level in Reservoir:
 - A. Consult owner/operators manual for the proper type fluid and level
8. Inspect Heat Exchanger for:
 - A. Obstructed air flow (air cooled)
 - B. Obstructed water flow (water cooled)
 - C. Improper plumbing (inlet to outlet)
 - D. Obstructed or insufficient fluid flow
 - E. Cooling fan failure (if used)
9. Inspect Heat Exchanger By-Pass Valve for:
 - A. Improper pressure setting
 - B. Stuck or broken valve

Hydraulic Fluid Recommendations

Introduction

The ability of Eaton hydrostatic components to provide the desired performance and life expectancy depends largely on the fluid used. One of the most important characteristics to consider when choosing a fluid to be used in a hydraulic system is viscosity. Viscosity choice is always a compromise; the fluid must be thin enough to flow easily but thick enough to seal and maintain a lubricating film between bearing and sealing surfaces. Viscosity requirements are specified later in this document.

Viscosity and Temperature

Fluid temperature affects viscosity. In general, as the fluid warms it gets thinner and viscosity decreases. The opposite is true when fluid cools.

When choosing a fluid, consider the start-up and operating temperatures of the hydrostatic system. Generally, the fluid is thick when the hydraulic system is started. With movement, the fluid warms to a point where the cooling system begins to operate. From then on, the fluid is maintained at the temperature for which the hydrostatic system was designed.

In actual applications this sequence varies; hydrostatic systems are used in many environments from very cold to very hot. Cooling systems also vary from very elaborate to very simple, so ambient temperature may affect operating temperature

Cleanliness

Cleanliness of the fluid is extremely important. Eaton recommends that the fluid used in its hydrostatic components be maintained at ISO Cleanliness Code 18/13 per SAE J1165. The code allows a maximum of 2500 particles per milliliter greater than 5 μm and a maximum of 80 particles per milliliter greater than 15 μm . When components with different cleanliness requirements are used in the same system, the cleanest standard should be applied. A reputable filter supplier can supply filter information.

Fluid Maintenance

Maintaining correct fluid viscosity and cleanliness level is essential for all hydrostatic systems. Field testing and monitoring are the only ways to get accurate measurements of system cleanliness. Test and establish fluid maintenance schedules designed to meet the viscosity and cleanliness requirements.

Fluid Selection

Premium grade petroleum based hydraulic fluids will provide the best performance. These fluids typically contain additives that are beneficial. Eaton recommends fluids that contain anti-wear agents, rust inhibitors, anti-foaming agents, and oxidation inhibitors. Premium grade petroleum-based hydraulic fluids carry an ISO VGA rating.

SAE grade crankcase oils may be used, but it should be noted that these oils may not contain all of the recommended additives. Using crankcase oils may increase fluid maintenance requirements.

Hydraulic fluids that contain V.I. (viscosity index) improvers, sometimes called multi-viscosity oils, may be used. These V.I.-improved fluids are known to "shear-down" with use. Their actual viscosity drops below the rated value. Fluid maintenance must be increased if V.I.-improved fluids are used. Automotive automatic transmission fluids contain V.I. improvers.

Synthetic fluids may be used. A reputable fluid supplier can provide information on synthetic fluids. Review applications that require the use of synthetic fluids with your Eaton representative.

Hydraulic Fluid Recommendations

Viscosity/Cleanliness Guidelines

MINIMUM	OPTIMUM RANGE	ISO CLEANLINESS MAXIMUM	REQUIREMENTS
10cSt [60 SUS]	16 - 39 cSt [80 - 180 SUS]	2158 cSt [10,000 SUS]	18/13

Additional Notes:

- Fluids too thick to flow in cold weather start-ups will cause pump cavitation and possible damage. Motor cavitation is not a problem during cold start-ups. Thick oil can cause high case pressures which in turn cause shaft seal problems.
- If the color of the fluid has become black, it is possible an overheating problem exists.
- If the fluid becomes milky, water contamination may be a problem.
- Take fluid level reading when the system is cold.
- Contact your Eaton representative if you have specific questions about the fluid requirements.

Biodegradable Oil (Vegetable) Guidelines

RATING WITH BIODEGRADABLE OIL	COMMENTS
80% of normal pressure rating listed for mineral oils.	82° C (180° F) max fluid temp (unit) 71° C (160° F) max fluid temp (reservoir)

Additional Notes:

- Viscosity and ISO cleanliness requirements must be maintained as outlined.
- Based on limited product testing to date, no reduction in unit life is expected when operating at the pressure ratings indicated above.
- Vegetable oil is miscible with mineral oil. However, only the vegetable oil content is biodegradable. Systems being converted from mineral oil to vegetable oil should be repeatedly flushed with vegetable oil to ensure 100% biodegradability.
- Specific vegetable oil products may provide normal unit life when operating at pressure ratings higher than those indicated above.

Special Tools

End Cover Tools

End Cover Tool #1

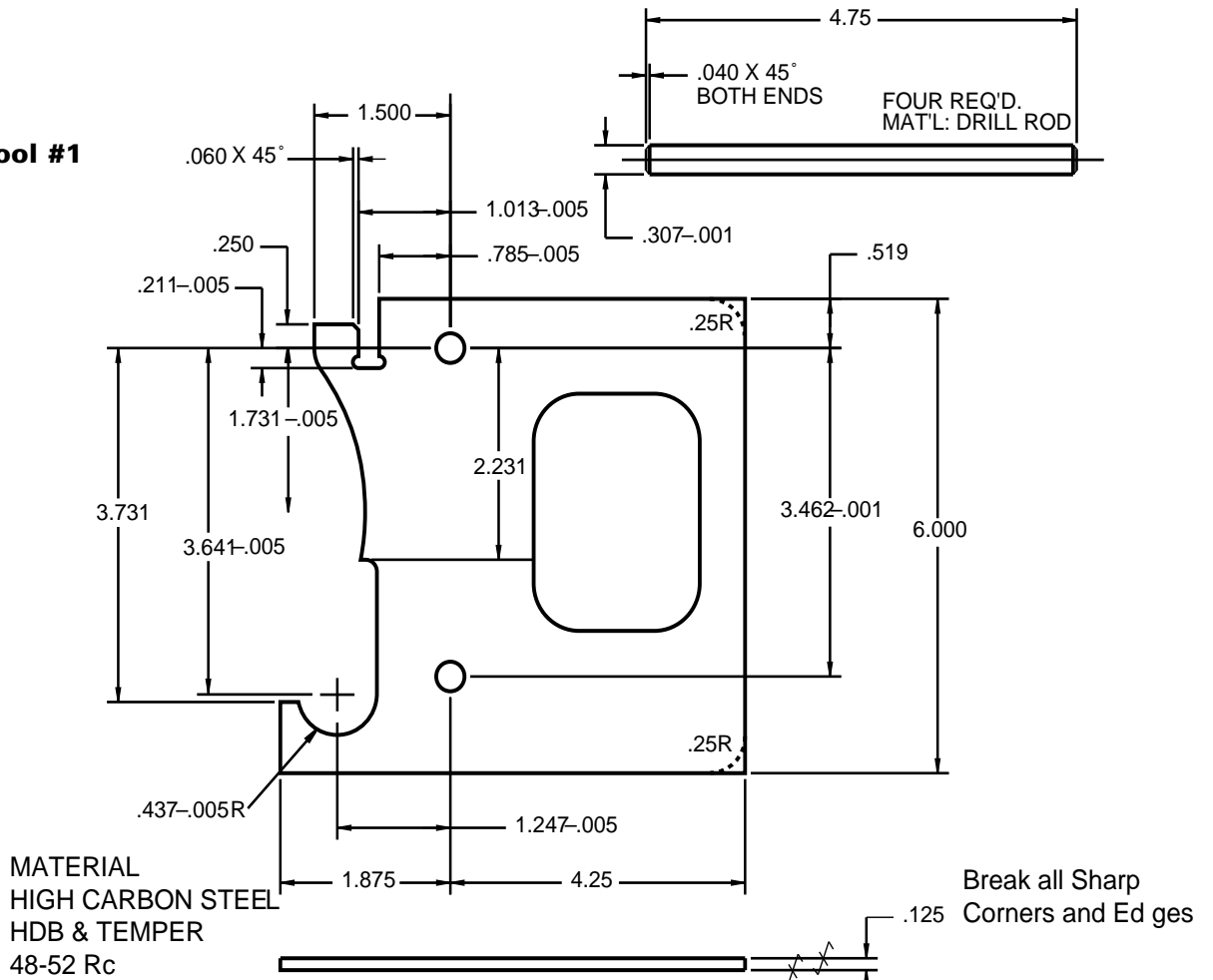

End Cover Tool #2

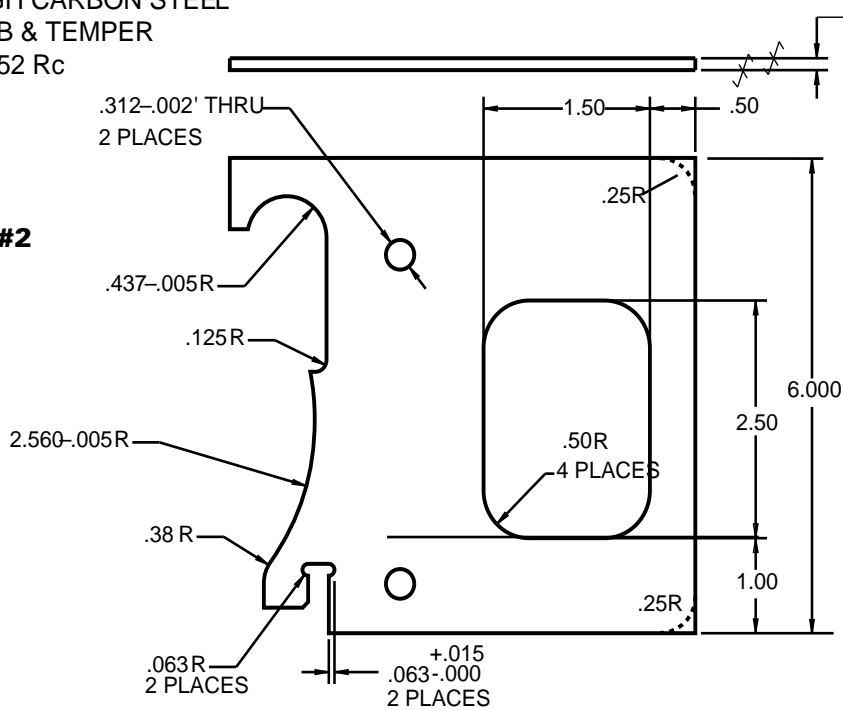

Special Tools

Main Shaft Bearing Stop Limit Tool

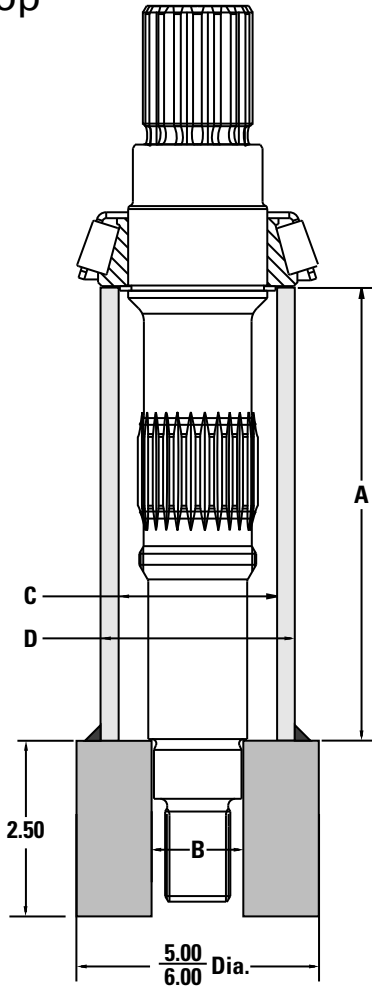

It is recommended that replacement shafts be purchased as an assembly with the bearing already pressed into place. In the event a bearing is replaced in the field, it must be pressed into place to the following dimensions in order to prevent damage to the pump.

(±.030)D	A (±.001)		B (±.030)	C
Models 33/39/46	6.113	1.31	2.18	3.00 min.
Models 54/64	6.692	1.37	2.32	3.00 min.

(All dimensions are given in inches.)

Material – Steel

(All dimensions are given in inches.)

Low Clearance Bearing Puller

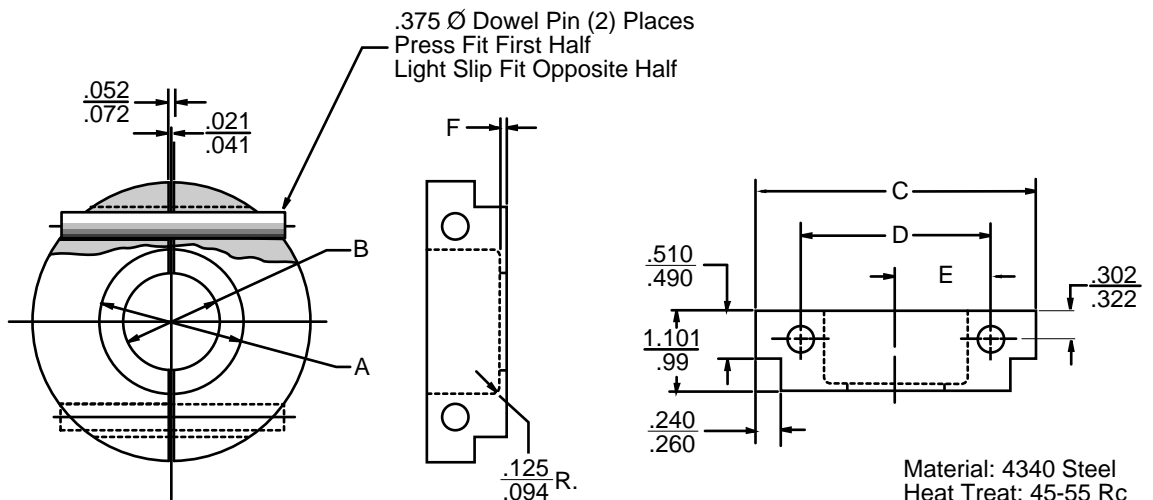

Material: 4340 Steel
Heat Treat: 45-55 Rc

Material – Stentor

Heat Treatment – 45-55 Rc

(All dimensions are given in inches.)

	A	B	C	D	E	F
Models 3322/3922/4622	2.36/2.38	1.55/1.57	4.26/4.24	2.99/3.01	1.49/1.51	.130/.140
Models 5422/6422	2.55/2/57	1.64/1.66	4.46/4.43	3.18/2.21	1.59/1.61	.180/.190

(All dimensions are given in inches.)

Special Tools

Shaft Seal Installation Tools & Instructions

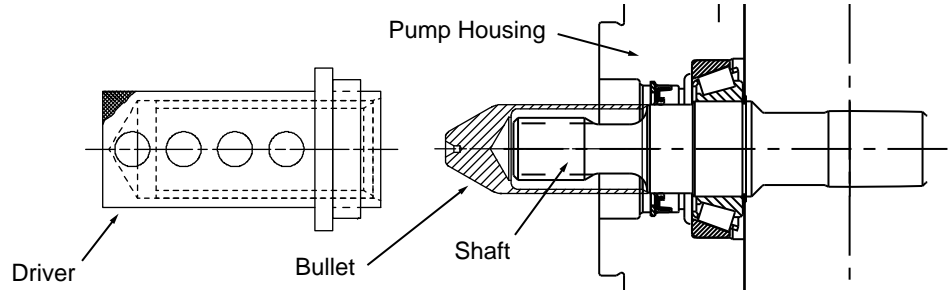

Ensure the shaft sealing surface and housing seal bore are clean and free of all dirt and debris to avoid introducing any contaminants into unit.

1. Grease the inside surface of seal that contacts shaft.
2. Select correct bullet and driver. Bullet and drive shaft chamfer must align with each other leaving no gap between the bullet and shaft. Bullet should pilot on shaft diameter so bullet cannot shift side to side, allowing step between bullet and shaft seal diameter.
3. Press the new, greased shaft seal over a shaft bullet. Closed face of the shaft seal faces the closed end of the bullet.

4. With the shaft seal on the bullet, insert bullet over drive shaft and into the seal pocket. Take care to ensure seal is properly aligned with housing bore as seal is pressed in to minimize chance of damaging seal.
5. Using the driver and a mallet, push the seal until the tool bottoms on the pilot of flange.
6. Remove the tool and insert the retaining ring into the seal pocket. A spacer is required, whenever there is a significant groove in the shaft from the seal. (A maximum of two spacers may be used before the shaft must be replaced), place it between the shaft seal and the retaining ring.
7. Using the tool and mallet, drive the seal, spacer (as required if using), and retaining ring in until the retaining ring snaps into place in the groove.

Bullet/Driver Selection

Each seal requires use of a specific bullet and driver. Check measurements and/or part numbers of bullet and driver to determine the correct bullet and driver to use for your unit.

Measurements are expressed in standard mm[Inch].

* (units using seal 108395-000)

** (units using seal 110192-000)

Units using seal 108395-000

SEAL ID	BULLET	DRIVER
1.750	4994026-001	4994028-001

Units using seal 110192-000

SEAL ID	BULLET	DRIVER
1.875	4994027-001	4994028-002

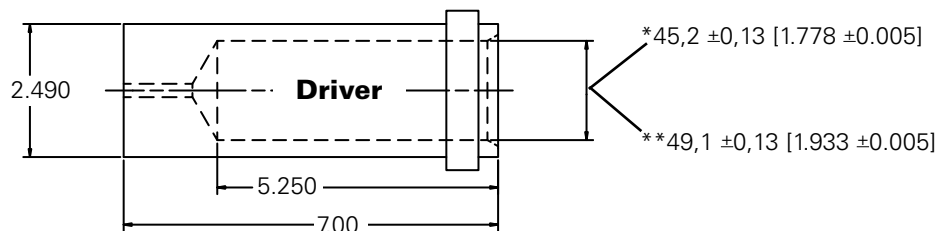
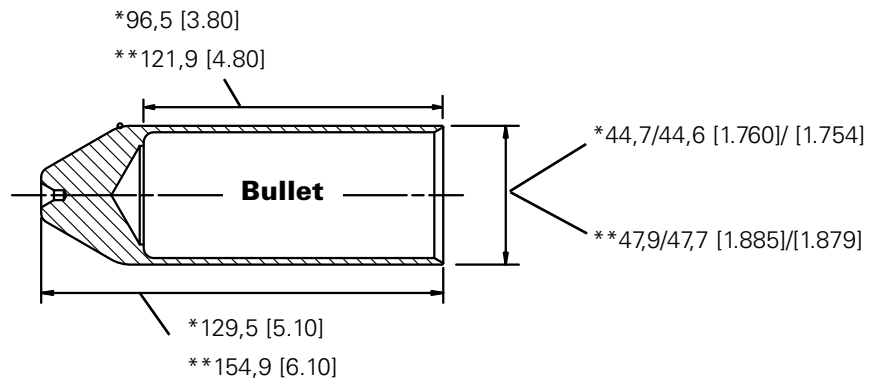

Model Codes

The following 31-digit coding system has been developed to identify all of the configuration options for the Series 2 hydrostatic pump. Use this model code to specify a pump with the desired features. All 31-digits of the code must be present when ordering. You may want to photocopy the matrix below to ensure that each number is entered in the correct space.

1	2	3	4	5	6	7	8	9	10	11	12	13	14	15	16	17	18	19	20	21	22	23	24	25	26	27	28	29	30	31
A	C	L																				0								A

1 2 3 Product Series

ACL Hydrostatic-Heavy Duty Variable Pump (Series 2)

4 5 6 Displacement

054 54 cm³/r [3.316 in³/r] at 15.5 DEG
 064 64 cm³/r [3.885 in³/r] at 18 DEG
 075 75 cm³/r [4.594 in³/r] at 18 DEG
 089 89 cm³/r [5.439 in³/r] at 18 DEG
 105 105 cm³/r [6.431 in³/r] at 18 DEG

7 8 Input Shaft

01 21 Tooth 16/32 Pitch Spline with [3.22] Extension
 02 23 Tooth 16/32 Pitch Spline with 3/8-24 UNF x 19.05 [1.750] minimum full thread in end of shaft
 03 38 [1.50] diameter tapered with 9.525 [.375] x 25.4 [1.00] square key
 13 13 Tooth 8/16 Pitch Spline [089-105]
 14 14 Tooth 12/24 Pitch Spline
 15 14 Tooth 12/24 Pitch Spline [1.56] Extension, for Rear Pump of Tandem, Mates to Front Pump with Integral C-Pad and Charge Pump
 16 14 Tooth 12/24 Pitch Spline with 3/8-24 UNF X 19,05 [1.750] minimum full thread in end of shaft
 21 21 Tooth 16/32 Pitch Spline
 23 23 Tooth 16/32 Pitch Spline
 27 27 Tooth 16/32 Pitch Spline
 28 27 Tooth 24/48 Pitch Spline
 29 27 Tooth 24/48 Pitch Spline for Rear Pump of Tandem, Mates to Front Pump with Integral C-Pad [054-075]

9 Input Rotation

L Counterclockwise (Lefthand)
 R Clockwise (Righthand)

10 Valve Plate

0 V-Groove
 1 Propel
 3 Quiet Valve Plate

11 Main Ports (Includes Gauge Ports)

A 25,4 [1.00] - Code 61 Per SAE J518
 B 25,4 [1.00] - Code 62 Per SAE J518
 C 25,4 [1.00] - Code 61 with M10 X 1 Threaded Holes
 D 25,4 [1.00] - Code 62 with M12 X 1.75 Threaded Holes
 E 25,4 [1.00] - code 62 per SAE J518 same side location
 F 25,4 [1.00] - code 61 per SAE J518 same side location
 G 25,4 [1.00] - Code 62 with M12 X 1.75 Threaded Holes same side location

12 13 High Pressure relief Valve Setting Ports A & B

NOTE: You must choose relief valve settings for both ports A & B

0 None
 2 138 bar [2000 lbf/in²] with 2 bar [29 lbf/in²]
 3 172 bar [2500 lbf/in²] with 2 bar [29 lbf/in²]
 M 207 bar [3000 lbf/in²] with 2 bar [29 lbf/in²]
 N 241 bar [3500 lbf/in²] with 2 bar [29 lbf/in²]
 P 276 bar [4000 lbf/in²] with 2 bar [29 lbf/in²]
 R 310 bar [4500 lbf/in²] with 2 bar [29 lbf/in²]
 S 345 bar [5000 lbf/in²] with 2 bar [29 lbf/in²]
 T 379 bar [5500 lbf/in²] with 2 bar [29 lbf/in²]
 U 414 bar [6000 lbf/in²] with 2 bar [29 lbf/in²]
 V 430 bar [6250 lbf/in²] with 2 bar [29 lbf/in²]
 W 448 bar [6500 lbf/in²] with 2 bar [29 lbf/in²]
 Y 483 bar [7000 lbf/in²] with 2 bar [29 lbf/in²]

14 15 Pressure Override (POR) Setting Ports A & B

NOTE: You must choose pressure override settings for both ports A and B. The pressure override setting should be 35 bar less than the high pressure relief valve.

0 None
 1 448 bar [6500 lbf/in²] Adjustable Range 379-448 bar [5500-6500 lbf/in²]
 2 395 bar [5750 lbf/in²] Adjustable Range 310-414 bar [4500-6000 lbf/in²]
 A Pressure Transducer (No pressure override valve)
 N 103 bar [1500 lbf/in²] Adjustable Range 103-275 bar [1500-4000 lbf/in²]
 P 138 bar [2000 lbf/in²] Adjustable Range 103-275 bar [1500-4000 lbf/in²]
 R 172 bar [2500 lbf/in²] Adjustable Range 103-275 bar [1500-4000 lbf/in²]
 S 207 bar [3000 lbf/in²] Adjustable Range 103-275 bar [1500-4000 lbf/in²]
 T 241 bar [3500 lbf/in²] Adjustable Range 103-275 bar [1500-4000 lbf/in²]
 U 276 bar [4000 lbf/in²] Adjustable Range 241-345 bar [3500-5000 lbf/in²]
 V 310 bar [4500 lbf/in²] Adjustable Range 241-345 bar [3500-5000 lbf/in²]
 W 345 bar [5000 lbf/in²] Adjustable Range 310-414 bar [4500-6000 lbf/in²]
 Y 379 bar [5500 lbf/in²] Adjustable Range 310-414 bar [4500-6000 lbf/in²]
 Z 414 bar [6000 lbf/in²] Adjustable Range 379-448 bar [5500-6500 lbf/in²]

Model Codes (con't)

16 17 Special Pump Features

- 00 No Special Features
- 01 Plugged Magnetic Speed Sensor Port
- 02 Magnetic Speed Sensor
- 03 Adjustable Servo Stop (one direction, servo bolt side)
- 12 Rear Pump Unit for Tandem Assembly (no shaft seal)
- 13 Servo Piston with Externally Adjustable Stops in Both Directions
- 14 Rear Pump Unit for Tandem Assembly (no shaft seal), Servo Piston, with Externally Adjustable Stops in Both Directions
- 19 Adjustable Servo Stop (one direction, opposite of servo bolt)
- 20 Rear Pump Unit for Tandem Assembly (no shaft seal, adjustable servo stop in one direction, opposite of servo bolt)

18 19 Control

- EC Electronic Proportional Control 12 Vdc without Electronic Driver
- ED Electronic Proportional Control 24 Vdc without Electronic Driver
- EE Electronic Proportional Control 12 and 24 Vdc and Electronic Driver with 1 to 6 Vdc Potentiometric Command Input
- EG Electronic Proportional Control 12 and 24 Vdc and Electronic Driver with ± 20 mA Command Input
- EL Electronic Proportional Control 12 and 24 Vdc and Electronic Driver with ± 100 mA Command Input
- FR Forward-Neutral-Reverse Control 12V with two 2-Pin Weatherpack Connectors
- FR Forward-Neutral-Reverse Control 24V with two 2-Pin Weatherpack Connectors
- HA Hydraulic Remote Control with 5-15 bar [73-218 lbf/in²]
- MA Manual Displacement Control
- MB Manual Displacement Control with Normally Closed Neutral Lockout Switch (Wide Band Neutral)
- MC Manual Displacement Control with Normally Open Neutral Lockout Switch (Wide Band Neutral)
- ML Manual Displacement Control with Wide Band Neutral
- PA Port Plate
- SE Solenoid Control 12 V with Non-contact Feedback Sensor with Electrical Connectors Per DIN 43650

20 Control Orifice Supply (P)

21 Control Orifice Servo (S₁)

22 Control Orifice Servo (S₂)

- 0 None
- A 0,53 [.021] Diameter
- B 0,71 [.028] Diameter
- C 0,91 [.036] Diameter
- D 1,12 [.044] Diameter
- E 1,22 [.048] Diameter
- F 1,32 [.052] Diameter
- G 1,45 [.057] Diameter
- H 1,65 [.065] Diameter
- J 1,85 [.073] Diameter
- K 2,06 [.081] Diameter
- L 2,39 [.094] Diameter
- M 2,59 [.102] Diameter

23 Control Special Features

- 0 No Control Special Features
- 3 Destroke Valve

24 Charge Pump Displacement

- 0 None

- 1 13,9 cm³/r [0.85 in³/r] (Models 054–089)
- 2 17,4 cm³/r [1.06 in³/r] (Models 054–105)
- 3 21,0 cm³/r [1.28 in³/r] (Models 054–105)
- 4 27,9 cm³/r [1.70 in³/r] (Models 054–105)
- 5 34,7 cm³/r [2.12 in³/r] (Models 089, 105)

25 Auxiliary Mounting

- 1 None (Models 054–105)
- C A-Pad, Dual 2 Bolt Mount, No Shaft Seal, 9 Tooth 16/32 Pitch Spline
- D B-Pad, Dual 2 Bolt Mount, No Shaft Seal, 13 Tooth 16/32 Pitch Spline
- E B-B-Pad, Dual 2 Bolt Mount, No Shaft Seal, 15 Tooth 16/32 Pitch Spline
- F C-Pad, 4 Bolt Mount, No Shaft Seal, 14 Tooth 12/24 Pitch Spline
- H C-Pad, Integral to End Cover (typically front pump of tandem), 4 Bolt Mount, No Shaft Seal, 27 Tooth 24/48 Pitch Spline
- J C-Pad, Integral to End Cover (typically front pump of tandem), 4 Bolt Mount, No Shaft Seal, 14 Tooth 12/24 Pitch Spline for units with Charge Pump
- K A-Pad, Dual 2 Bolt Mount, No Shaft Seal, 9 Tooth 16/32 Pitch Spline
- L B-B-Pad, Dual 2 Bolt Mount with metric thread, No Shaft Seal, 15 Tooth 16/32 Pitch Spline

26 Charge Pump Options

- 0 None
- A Remote Filter Ports

27 Charge Pressure Relief Valve Setting

- A 21 bar [304.5 lbf/in²] - Standard
- B 22,5 bar [326.3 lbf/in²]
- C 24 bar [348 lbf/in²]
- D 25,5 bar [369.8 lbf/in²]
- E 27 bar [391.5 lbf/in²]
- F 28,5 bar [413.4 lbf/in²]
- G 30 bar [435.1 lbf/in²]
- H 23 bar [340 lbf/in²]
- J 18 bar [260 lbf/in²]
- K 22 bar [320 lbf/in²]
- L Orificed Low Pressure Valve

28 Charge Pump Special Features

- 0 No Charge Pump Special Features

29 Paint and Packaging

- 0 Painted Primer Blue (Standard)

30 Identification On Unit

- 0 Standard

31 Design Code

- A A

Eaton
14615 Lone Oak Road
Eden Prairie, MN 55344
USA
Telephone: 952 937-9800
Fax: 952 974-7722
www.hydraulics.eaton.com

Eaton
20 Rosamond Road
Footscray
Victoria 3011
Australia
Tel: (61) 3 9319 8222
Fax: (61) 3 9318 5714

Eaton
Dr. Reckeweg-Str. 1
D-76532 Baden-Baden
Germany
Tel: (49) 7221 682-0
Fax: (49) 7221 682-788



Hydraulics

© 2004 Eaton Corporation
All Rights Reserved
Printed in USA
Document No. E-PUPI-TS004-E
October 2004