

COOPER POWER
SERIES

ASN series AC metal-enclosed switchgear and controlgear

Safe, Green and Efficient

MV/LV Assemblies

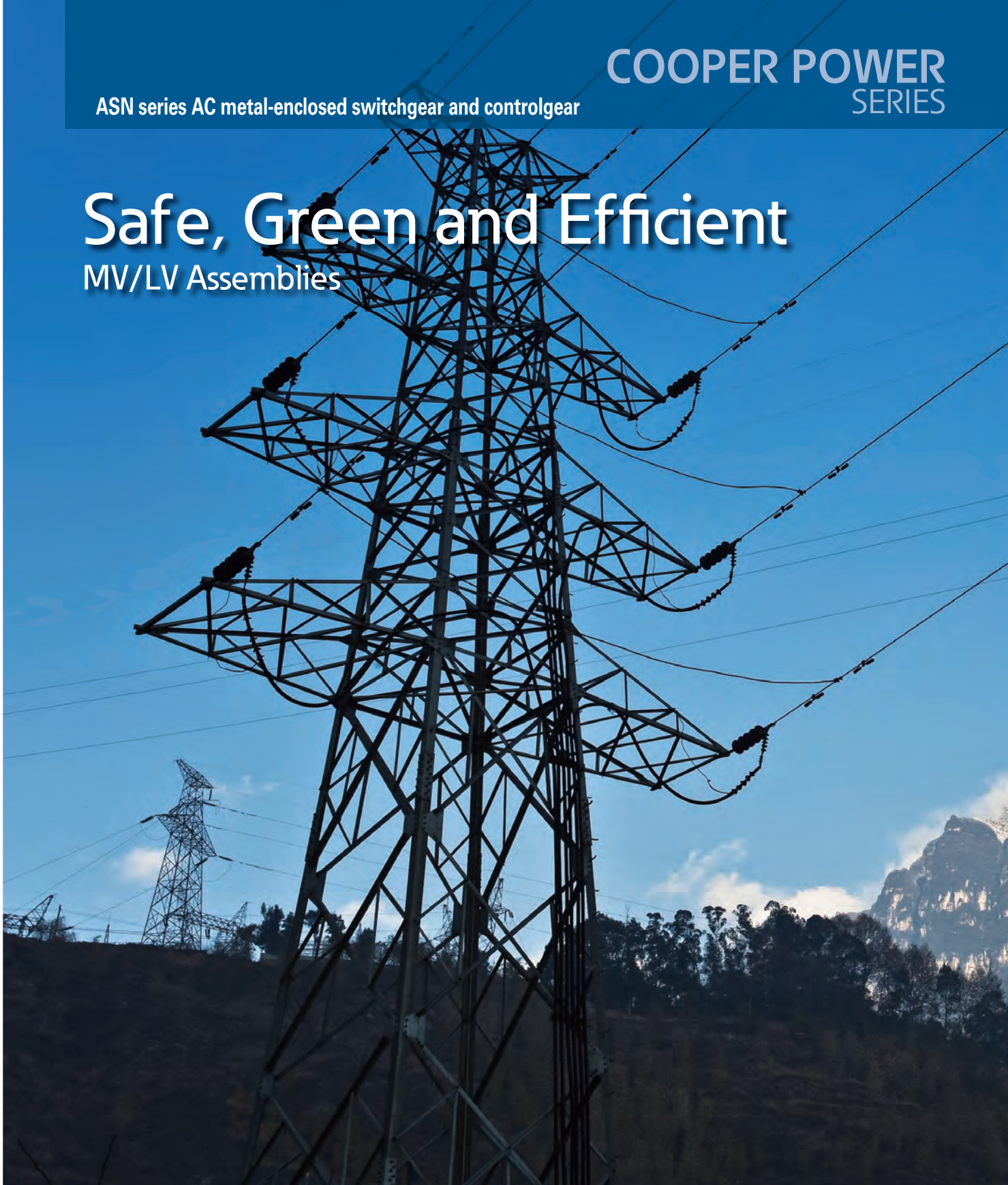

EATON

Powering Business Worldwide

COOPER



Automotive



Aerospace



Truck



Hydraulics



Electrical

Powering business worldwide

Eaton delivers the power inside hundreds of products that are answering the demands of today's fast changing world.

We help our customers worldwide manage the power they need for buildings, aircraft, trucks, cars, machinery and entire businesses. And we do it in a way that consumes fewer resources.

Next generation transportation

Eaton is driving the development of new technologies – from hybrid drivetrains and emission control systems to advanced engine components – that reduce fuel consumption and emissions in trucks and cars.

Higher expectations

We continue to expand our aerospace solutions and services to meet the needs of new aviation platforms, including the high-flying light jet and very light jet markets.

Building on our strengths

Our hydraulics business combines localised service and support with an innovative portfolio of fluid power solutions to answer the needs of global infrastructure projects, including locks, canals and dams.

Powering Greener Buildings and Businesses

Eaton's Electrical Group is a leading provider of power quality, distribution and control solutions that increase energy efficiency and improve power quality, safety and reliability. Our solutions offer a growing portfolio of "green" products and services, such as energy audits and real-time energy consumption monitoring. Eaton's Uninterruptible Power Supplies (UPS), variable-speed drives and lighting controls help conserve energy and increase efficiency.



Cooper Industries Group & Cooper (Ningbo)

The former Cooper Industries Group is a global cross-industry equipment manufacturer. With nearly 200 years of history and upwards of 30,000 employees worldwide, it owns 100-plus manufacturing bases in 23 countries. Cooper (Ningbo), a joint venture under Cooper Industries Group, is invested and established by Cooper China Investment Limited in 2007. It boasts several world-class production lines, covering nearly 30 kinds of products in 6 categories. The products are widely used in such sectors as data center, power grid, power generation, petrochemical, metallurgy, rail transportation, and infrastructure, and is a complete distribution solution and service provider.

Eaton Electrical

Eaton, as a leading global power management company, boasts a slew of industry-leading technologies and is dedicated to helping customers make more efficient and safer use of power, fluid power and mechanical power. It employs 97,000 employees worldwide, with its products exported to 175-plus countries and regions. As early as 1993, Eaton set up the first joint venture in the Chinese market. Then, it has realized rapid sustainable development via mergers and acquisitions, joint ventures and whollyowned enterprises. It has achieved a sales revenue of \$1 billion in the Chinese market in 2010.

Integration And Development

In 2012, Eaton Electrical Group had fully acquired Cooper Industries Group. The two leaders in the electrical sector form to become a new global leader in power management. Cooper (Ningbo) is the strategic arm of Cooper Electric System for Asia Pacific region, global IEC product manufacturing base of Eaton, and UX36 and W-VACi manufacturer. We undertake the production of many advanced technologies and products in the electrical field. It boasts outstanding achievements in industry innovation in terms of manufacturing process and product design. Cooper (Ningbo), by virtue of its many advantages, joins hands with Eaton in bringing more focused, effective solutions for its customers, in a bid to create unmatched customer value.



Cooper (Ningbo) is committed to providing customers with top-drawer products. Departing from traditional switchgear manufacturing model, it designs and installs the industry's most revolutionary intelligent production lines for switchgear. This innovation converts the former production mode into hightech intelligent management, marking a quantum leap for science and technology.

LSN and EPM series low-voltage switchgear assembly line uses power roller and transfer trolley for transport. The entire line adopts computers for centralized control, integrating assembly of electrical components, secondary wiring and the whole machine detection function. The standard process control safeguards product quality.



Cooper (Ningbo) pursues high quality and first-class, safest, most reliable products. It boasts leading one-stop testing equipment in the industry, including conventional testing lab, electrical performance testing lab, mechanical performance testing lab, physical and chemical lab, precision measurement lab and X-Ray detection room and so on. Cooper (Ningbo) ensures to provide customers with the most efficient safe and reliable products.

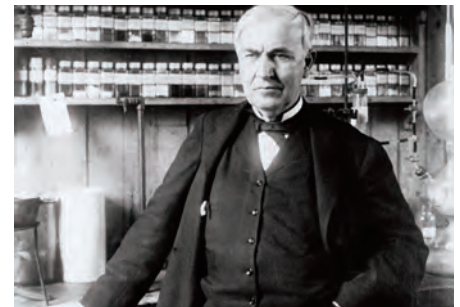

In 2005, Edison R & D Center – the only R & D Center named after the great inventor Thomas Edison – was located in China, and in 2009 set up Edison (Ningbo) R & D sub-center at Cooper (Ningbo). In recent years, Cooper (Ningbo), relying on this R & D center, has formed industry-university-research cooperation with new characteristics in accordance with medium and long-term strategic planning, providing a strong impetus to the exceptional development of the company's innovative capability.

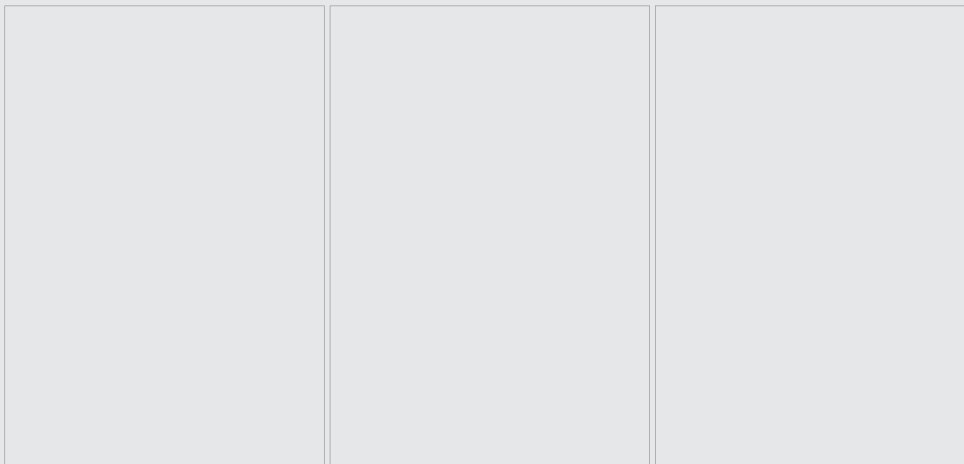
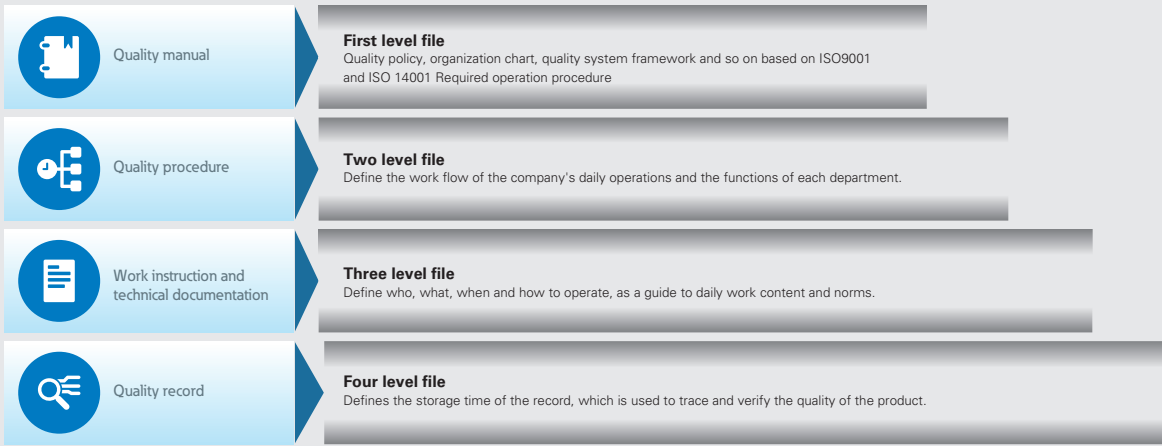

In accordance with the requirements of ISO9001 quality system, we have established a complete file system covering ISO9001- 2000 and ISO14001 files, which guarantees the consistency and stability of the management process. At the same time, each Cooper employee is required to undergo pre-job training, and standard operating instructions are provided at the production site, in order to ensure that production operations are conducted as per the standard process. Thus, it ensures that each product produced by Cooper (Ningbo) is safe and reliable.



National and industry standards

Standards compliant

The design and manufacture of ASN3-12 switchgear meet the following standards:

- GB3906: AC metal-enclosed switchgear and controlgear for rated voltages of 3.6-40.5kV
- GB/T11022: Common specifications for high-voltage switchgear and controlgear standards
- GB1984: Alternating current high-voltage circuit-breakers
- DL/T404: Alternating-Current metal-enclosed switchgear and controlgear for rated voltages above 3.6kV and up to and including 40.5kV
- IEC60694: Common specifications for high-voltage switchgear and controlgear standards
- IEC62271-100: high-voltage switchgear and controlgear standards – Part 100: high-voltage AC circuit breakers
- IEC62271-200: Alternating-Current metal-enclosed switchgear and controlgear for rated voltages above 1kV and up to and including 52kV
- GB13540: Anti-seismic requirements of high-voltage switchgear and controlgear

Type test

- Protection class inspection
- Measurement of loop resistance
- Temperature rise test
- Mechanical characteristic and mechanical operation test
- Mechanical life test
- Insulation test of operation mechanism and auxiliary loop
- Short-term power frequency withstand voltage test
- Lightning impact withstand voltage test
- Single-phase fault breaking capacity test
- Power and thermal stability test
- Vibration test



Type test report

Conditions of use environment

Ambient temperature ①	-15 °C to +40 °C
Average daily temperature	<35 °C
Altitude ②	<1000m
Relative humidity ③	Average daily value <95%
	Average monthly value <90%
Water vapor pressure value	Average daily value <2.2kPa
	Average monthly value <1.8kPa
Anti-seismic capacity	seismic intensity does not exceed 8 degree
Location for installation	The surroundings are free from obvious pollution of dust, smoke, corrosive and or flammable gases, steam or salt mist

① The rated current value of circuit breaker shall be lowered or fan is installed for compulsory heat dissipation if the ambient temperature exceeds +40°C;
 ② The external insulation strength of circuit breakers will reduce if the location for installation exceeds 1000m above sea level. Please consult the manufacturers for detailed requirements;
 ③ The switchgear is equipped with heater. If installed at a location with high humidity or large temperature fluctuations, the heater shall be turned on even under normal operation, in order to prevent condensation. The heat generated by the switchgear can be dissipated through additional ventilation facilities.

ASN series AC metal-enclosed switchgear and controlgear

Contents

ASN series AC metal-enclosed switchgear and controlgear

Product description	6
Structural features	7
Technical Parameters	10
ASN1-40.5 (G) AC metal-enclosed switchgear and control equipment	10
ASN2-24 AC metal-enclosed switchgear and control equipment	11
ASN3-12 AC metal-enclosed switchgear and control equipment	12
Primary wiring scheme	13
ASN1-40.5 (G) AC metal-enclosed switchgear and control equipment	13
ASN2-24 AC metal-enclosed switchgear and control equipment	18
ASN3-12 AC metal-enclosed switchgear and control equipment	22
External dimensions and mounting base drawing	27
ASN1-40.5 (G) AC metal-enclosed switchgear and control equipment	27
ASN2-24 AC metal-enclosed switchgear and control equipment	29
ASN3-12 AC metal-enclosed switchgear and control equipment	31

ASN series AC metal-enclosed switchgear and controlgear



ASN1-40.5



ASN2-24



ASN3-12

Product description

ASN series (ASN1-40.5, ASN2-24, ASN3-12) switchgear cabinet, as a new-generation medium-voltage AC metal-enclosed switchgear and controlgear developed by our company, is suited to three-phase AC 50/60Hz single bus and single bus segmented system. The products are mainly used for the acceptance and distribution of electrical energy, and for the circuit control, protection and monitoring in energy, industry, infrastructure, maritime and other fields.

Full range of specifications of ASN series switchgear:

- ASN1 switchgear has rated voltage of 40.5kV, rated current of up to 3150A, and rated short-circuit breaking current of up to 40kA;
- ASN2 switchgear has rated voltage of 24kV, rated current of up to 4000A, rated short-circuit breaking current of up to 40kA;
- ASN3 switchgear has rated voltage of 12kV, rated current of up to 5000A, and rated short-circuit breaking current of up to 50kA.

Loss category of operation continuity of switchgear: LSC2B.

Partition level inside cabinet: PM level.

Meet the 1.1Ir temperature rise requirements.

Arcing class: IAC AFLR Class.

ASN series switchgear is equipped with high-performance VN series indoor medium-voltage vacuum circuit breakers or CEC/F contactor-fuse combination appliance.

The housing of ASN series switchgear adopts high-quality aluminum-zinc coated steel through NC machine tool processing and bending; the key parts adopt double-bending structure, with high mechanical strength and high corrosion resistance.

Of a modular design, ASN series switchgear mainly consists of the handcart chamber, cable chamber, bus chamber, and instrument chamber, and the housing protection class is IP4X.

For the ASN series switchgear, the main busbar uses rounded busbar, and the busbar end uses the fillet treatment; the electric field distribution is further optimized. Bus surface is covered with heat-shrinkable casing, so that switchgear has such features as compact structure, advanced technology, stable performance, safety and reliability.

ASN series switchgear has perfect and reliable mechanical interlocking device, and uses double error-prevention method with primarily mechanical interlock and supporting electrical interlock, thus effectively preventing accidental operation and safeguarding the equipment and personal safety.

ASN series switchgear allows the switching operation and handcart access only after its doors are closed, thus protecting the operator.

ASN series switchgear completes all the conventional test items as per China's national standards and international standards, and has passed the internal arc fault test, thus greatly improving the safety of switchgear.

ASN series AC metal-enclosed switchgear and controlgear

Structural features

Modular design

ASN series switchgear adopts modular design. The cabinet is composed of such basic modules as instrument chamber (A), handcart chamber (B), bus chamber (C), cable chamber (D) as well as transformer, grounding switch and contact box. It allows flexible and convenient assembly and has high structural strength.

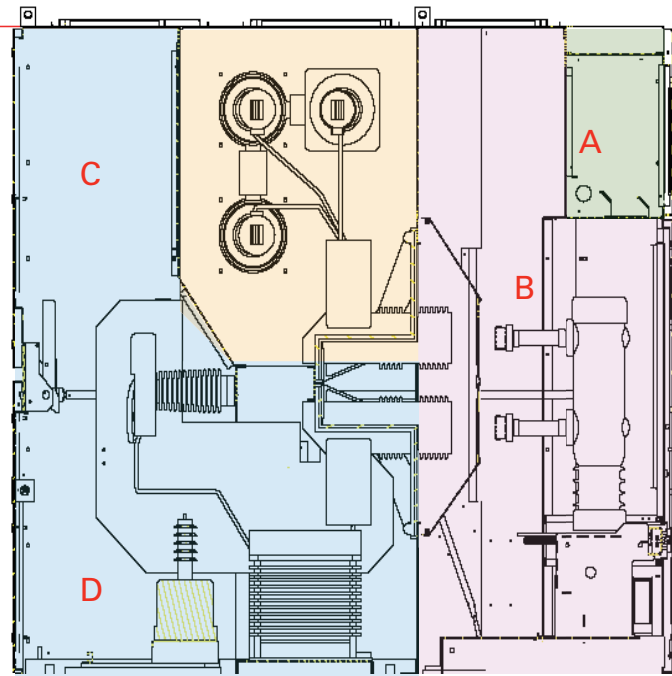

- A: Instrument chamber
- B: handcart chamber
- C: busbar chamber
- D: Cable chamber

ASN1-40.5

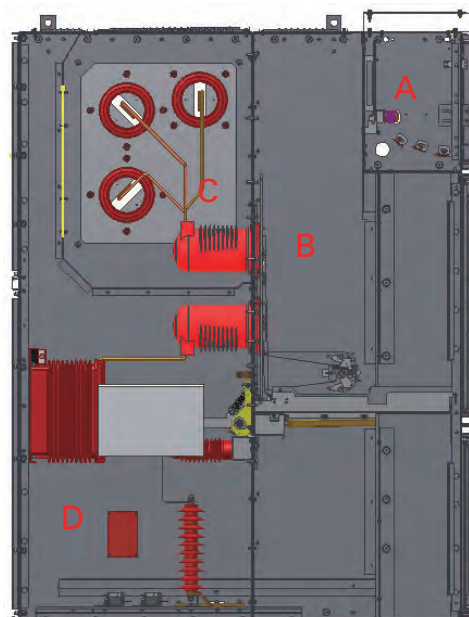

ASN2-24

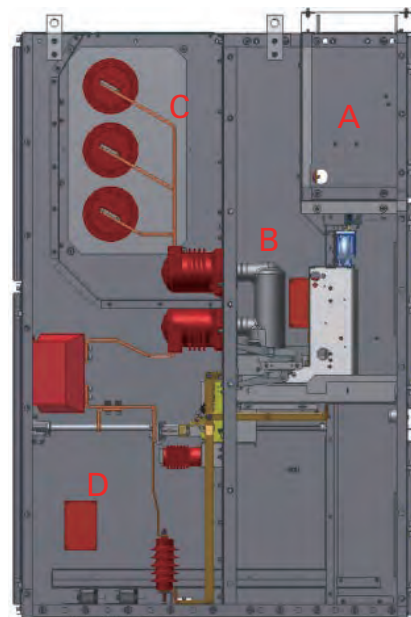

ASN3-12

ASN series AC metal-enclosed switchgear and controlgear

High-strength riveting process

Switchgear cabinet frame, made of aluminum riveted aluminum and zinc-coated steel plate, has high strength and high assembling efficiency, with a simple and beautiful appearance. The riveting has reasonable distribution of stress, thus reducing the possibility of structural damage and deformation.

The riveting process makes it possible to replace the middle switchgear on site. When it needs to replace the middle switchgear due to failure, field personnel can easily pull out the middle switchgear thanks to the riveting process.



Safe pressure relief channel

Automatic pressure relief device is equipped above the switchgear's circuit breaker chamber, bus chamber, and cable chamber. When there is arc inside the chamber due to a fault, the internal pressure of switchgear rises. Special sealing ring installed on the door will enclose the door, and the top pressure relief metal plate is automatically opened to release the pressure and high temperature, ensuring the safety of adjacent chambers and operation and maintenance personnel and meeting the requirements of IAC-class switchgear.

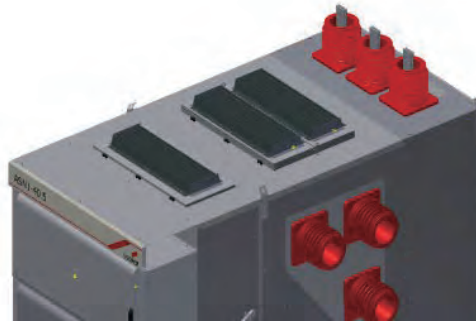

ASN1-40.5

Unique metal shutter design

The static contact box for incoming and outgoing line of circuit breaker uses the fluidized metal shutter. Thus, the outer surface insulation capacity is greatly improved; also, when the breaker's handcart exits the work position, the metal shutter automatically closes and blocks the static contact box, thus meeting the requirements of IP2X protection class. Therefore, it ensures that operation and maintenance personnel will not accidentally touch the live static contact of switchgear, thereby ensuring personal safety.

When the circuit breaker is at the removed position, the shutter drive mechanism can be equipped with padlock to prevent accidents which may occur when non-professional switchgear operation and maintenance personnel forcibly open the shutter.

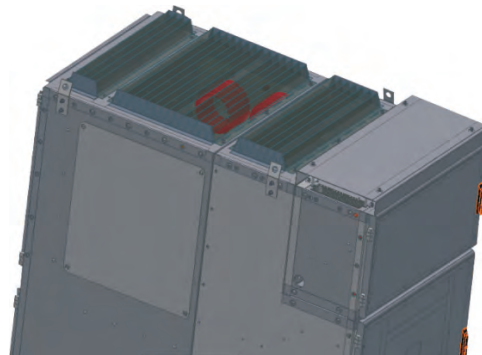

ASN2-24

Detachable instrument chamber

The instrument chamber is designed with a detachable module. The assembly and wiring of low-voltage components are completed on the assembly platform, and the devices are then installed on the cabinet to improve the appearance and safety of the low voltage wiring, and facilitate the maintenance and overhaul by operators.

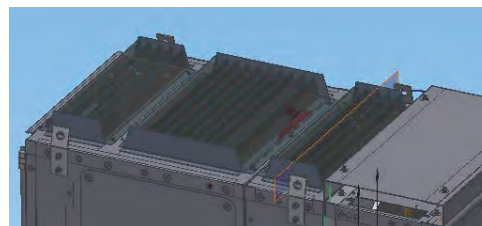

ASN3-12

Design of convection ventilation

There is air duct at the bottom of circuit breaker chamber. When the circuit breaker has rising operating temperature, the hot air rises, and the cold air enters through the bottom to achieve natural ventilation, thus conducive to heat dissipation during the normal operation of circuit breaker.

ASN series AC metal-enclosed switchgear and controlgear

Flexible and reliable handcart propulsion mechanism

The circuit breaker chamber is equipped with handcart rails, and the handcart equipped with screw rod and nut propulsion mechanism makes it easier for operation inside the chamber, and also improves the reliability of the switchgear structure, thus avoiding the vibration of handcart inside the chamber due to external mechanical force.

Spacious cable chamber

Spacious cable chamber makes it easier for construction and maintenance personnel to enter the switchgear cabinet for installation and maintenance.

Each phase is connected with at most six single-core cables or three 3-core cables.

Voltage transformers, current transformers, grounding switches, surge arresters, sensors and other components can be installed inside the cable chamber.

Safe and reliable mechanical interlock

The switchgear put in place comprehensive measures to prevent misuse, and is equipped with reliable mechanical electrical locking device, thus fully meeting the following requirements: prevent mistaken opening and closing of circuit breaker; prevent pushing or pulling circuit breaker handcart with load; prevent the live grounding switch; prevent closing earthing switch with hot-line job; preventing pushing circuit breaker handcart when the earthing switch is off; prevent mistaken entry into the live chamber; thus, it can protect the safety of the operator and the device itself to the utmost extent.

Circuit breakers have accurate positioning device at the working position and test position inside switchgear; mechanical locking ensures that it is allowed to close the circuit breaker only when the handcart of circuit breaker is at the exact working position or test position; meanwhile, only when the circuit breaker is at the opening status is it allowed to perform push-pull operation of the circuit breaker between the test position and the working position.

Circuit breaker has a mechanical lock between the receiving chamber and the secondary control plug, so as to prevent unplugging the second plug when circuit breaker handcart is at the working position, and avoid the continuous operation of switchgear without control and protection.

Anti-vortex mounting plate

Wall bushing installation plate, mounting plate of contact box, and bottom plate of cable outlet hole are made of stainless steel plate to effectively prevent the generation of vortex.

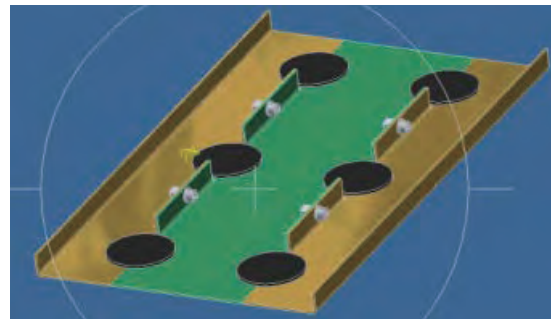

Some components are customized by professional manufacturers

Grounding switch, current/voltage transformer and other key components use the custom structure by specified suppliers, ensuring the product quality and delivery time, and also conducive to modular and standardized design. It has more convenient installation, more reliable switchgear quality, and shorter product lead time.

ASN series AC metal-enclosed switchgear and controlgear

Technical Parameters



ASN1-40.5

Item		Unit	Parameters
Switchgear type			ASN1-40.5
Rated voltage		kV	33/36/40.5
Rated frequency		Hz	50/60
Rated insulation level	1min power frequency withstand voltage (effective value)	kV	95/118
	Lightning impulse withstand voltage (peak)	kV	185/215
	Control circuit power frequency withstand voltage (1min)	V	2000
Rated current		A	1250, 1600, 2000, 2500, 3150
Rated short-circuit breaking current		kA	25, 31.5, 40
Rated short-circuit closing current		kA	63, 80, 100
Rated short-time withstand current (4s)		kA	25, 31.5, 40
Rated peak withstand current		kA	63, 80, 100
Auxiliary control circuit rated voltage ^①		V	AC110/220, DC110/220
Protection class			IP4X (or IP2X when the circuit breaker chamber door is opened or the compartment)
Arcing rating (IAC ALFR)		kA/1s	31.5/1

^① Please consult the manufacturers for special voltage rating requirements.

ASN series AC metal-enclosed switchgear and controlgear

Technical Parameters



ASN2-24

Item		Unit	Parameters
Switchgear type			ASN2-24
Rated voltage		kV	17.5/24
Rated frequency		Hz	50/60
Rated insulation level	1min power frequency withstand voltage (effective value)	kV	65/79
	Lightning impulse withstand voltage (peak)	kV	125/145
	Control circuit power frequency withstand voltage (1min)	V	2000
Rated current		A	630, 1250, 1600, 2000, 2500, 3150, 4000
Rated short-circuit breaking current		kA	25, 31.5, 40
Rated short-circuit closing current		kA	63, 80, 100
Rated short-time withstand current (4s)		kA	25, 31.5, 40
Rated peak withstand current		kA	63, 80, 100
Auxiliary control circuit rated voltage ^①		V	AC110/220, DC110/220
Protection class			IP4X (or IP2X when the circuit breaker chamber door is opened or the compartment)
Arcing rating (IAC ALFR)		kA/1s	31.5/0.5

^① Please consult the manufacturers for special voltage rating requirements.

ASN series AC metal-enclosed switchgear and controlgear

Technical Parameters



ASN3-12

Item		Unit	Parameters
Switchgear type			ASN3-12
Rated voltage		kV	3.6/7.2/12
Rated frequency		Hz	50/60
Rated insulation level	1min power frequency withstand voltage (effective value)	kV	42/48
	Lightning impulse withstand voltage (peak)	kV	75/85
	Control circuit power frequency withstand voltage (1min)	V	2000
Rated current		A	630, 1250, 1600, 2000, 2500, 3150, 4000, 5000
Rated short-circuit breaking current		kA	25, 31.5, 40, 50
Rated short-circuit closing current		kA	63, 80, 125, 137 (150)
Rated short-time withstand current (4s)		kA	25, 31.5, 40, 50
Rated peak withstand current		kA	63, 80, 125, 137 (150)
Auxiliary control circuit rated voltage ^①		V	AC110/220, DC110/220
Protection class			IP4X (or IP2X when the circuit breaker chamber door is opened or the compartment)
Arcing rating (IAC ALFR)		kA/1s	50/1

^① Please consult the manufacturers for special voltage rating requirements.

ASN series AC metal-enclosed switchgear and controlgear

Primary wiring scheme of ASN1-40.5 switchgear

Scheme No.

Drawing of primary wiring scheme

		1	2	3	4
Primary element	Rated current of main busbar (A)	630 ~ 3150	630 ~ 3150	630 ~ 3150	630 ~ 3150
	Vacuum circuit breaker/isolation handcart	1	1	1	1
	Current transformer	3	3	3	3
	Voltage transformer				
	High-voltage fuse				
	Earthing switch			1	1
	Lightning arrester		3		3
	Live display device	As required by user	As required by user	As required by user	As required by user
	Purpose	Cable inlet and outlet line	Cable inlet and outlet line	Cable inlet and outlet line	Cable inlet and outlet line + PT
	Remarks				

Scheme No.

Drawing of primary wiring scheme

		5	6	7	8
Primary element	Rated current of main busbar (A)	630 ~ 3150	630 ~ 3150	630 ~ 3150	630 ~ 3150
	Vacuum circuit breaker/isolation handcart	1	1	1	1
	Current transformer	3	3	3	3
	Voltage transformer	2	3		
	High-voltage fuse	3	3		
	Earthing switch	1	1		
	Lightning arrester				3
	Live display device	As required by user	As required by user	As required by user	As required by user
	Purpose	Cable inlet and outlet line + PT	Cable inlet and outlet line + PT	Overhead inlet-outlet line	Overhead inlet-outlet line
	Remarks				

ASN series AC metal-enclosed switchgear and controlgear

Primary wiring scheme of ASN1-40.5 switchgear

Scheme No.

Drawing of primary wiring scheme

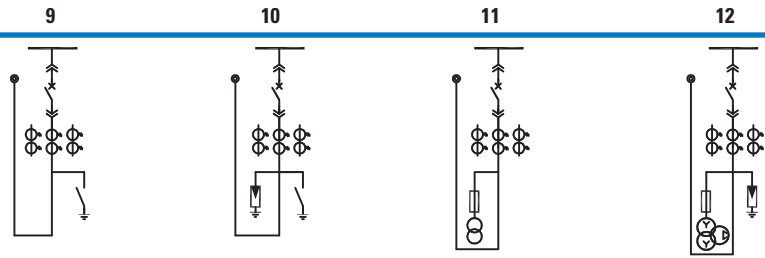

Primary element	Rated current of main busbar (A)	630 ~ 3150	630 ~ 3150	630 ~ 3150	630 ~ 3150
	Vacuum circuit breaker/isolation handcart	1	1	1	1
	Current transformer	3	3	3	3
	Voltage transformer			2	3
	High-voltage fuse			3	3
	Earthing switch	1	1		
	Lightning arrester		3		3
	Live display device	As required by user	As required by user	As required by user	As required by user
	Purpose	Overhead inlet-outlet line	Overhead inlet-outlet line	Overhead inlet-outlet line+PT	Overhead inlet-outlet line+PT
	Remarks				

Scheme No.

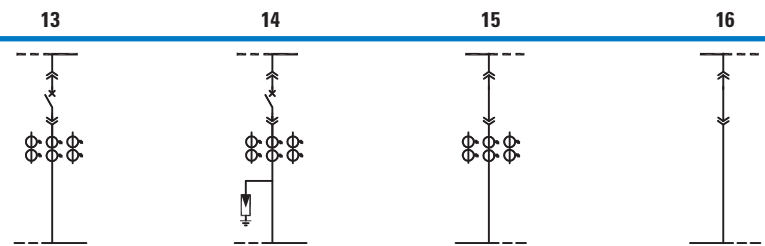

Drawing of primary wiring scheme



Primary element	Rated current of main busbar (A)	630 ~ 3150	630 ~ 3150	630 ~ 3150	630 ~ 3150
	Vacuum circuit breaker/isolation handcart	1	1	1	1
	Current transformer	3	3	3	
	Voltage transformer				
	High-voltage fuse				
	Earthing switch				
	Lightning arrester		3		
	Live display device	As required by user	As required by user	As required by user	As required by user
	Purpose	Bus coupler circuit breaker	Bus coupler circuit breaker	Bus coupler isolation	Bus coupler isolation
	Remarks				

ASN series AC metal-enclosed switchgear and controlgear

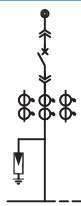
Primary wiring scheme of ASN1-40.5 switchgear

Scheme No.		17	18	19	20
Drawing of primary wiring scheme					
Primary element	Rated current of main busbar (A)	630 ~ 3150	630 ~ 3150	630 ~ 3150	630 ~ 3150
	Vacuum circuit breaker/isolation handcart	1	1	1	1
	Current transformer	3	3	3	
	Voltage transformer				
	High-voltage fuse				
	Earthing switch				
	Lightning arrester		3		
	Live display device	As required by user	As required by user	As required by user	As required by user
	Purpose	Overhead inlet line + contact	Overhead inlet line + contact	Overhead inlet line + isolation	Overhead inlet line + isolation
	Remarks				

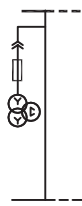
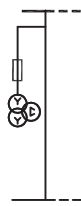
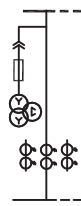
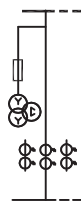
Scheme No.		21	22	23	24
Drawing of primary wiring scheme					
Primary element	Rated current of main busbar (A)	630 ~ 3150	630 ~ 3150	630 ~ 3150	630 ~ 3150
	Vacuum circuit breaker/isolation handcart	1		1	
	Current transformer			3	3
	Voltage transformer	3	3	3	3
	High-voltage fuse	3	3	3	3
	Earthing switch				
	Lightning arrester				
	Live display device	As required by user	As required by user	As required by user	As required by user
	Purpose	Bus coupler + PT	Bus coupler + PT	Measurement	Measurement
	Remarks				

ASN series AC metal-enclosed switchgear and controlgear

Primary wiring scheme of ASN1-40.5 switchgear

Scheme No.

Drawing of primary wiring scheme

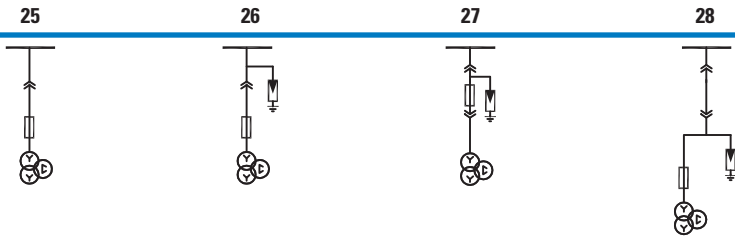

Primary element	Rated current of main busbar (A)	630 ~ 3150	630 ~ 3150	630 ~ 3150	630 ~ 3150
	Vacuum circuit breaker/isolation handcart	1	1	1	1
	Current transformer				
	Voltage transformer	3	3	3	3
	High-voltage fuse	3	3	3	3
	Earthing switch				
	Lightning arrester		3	3	3
	Live display device	As required by user	As required by user	As required by user	As required by user
	Purpose	PT	PT+lightning arrester	PT+lightning arrester	PT+lightning arrester
	Remarks				

Scheme No.

Drawing of primary wiring scheme

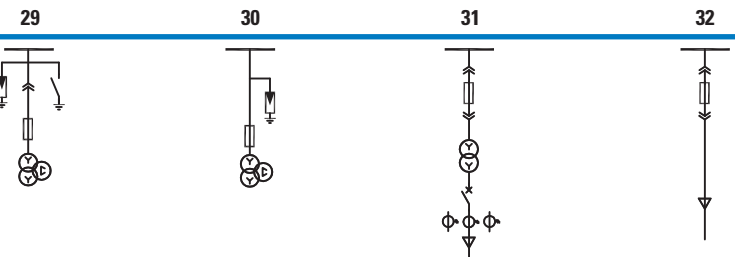

Primary element	Rated current of main busbar (A)	630 ~ 3150	630 ~ 3150	630 ~ 3150	630 ~ 3150
	Vacuum circuit breaker/isolation handcart	1		1	1
	Current transformer			3	
	Voltage transformer	3	3	1	
	High-voltage fuse	3	3	3	3
	Earthing switch	1			
	Lightning arrester	3	3		
	Live display device	As required by user	As required by user	As required by user	As required by user
	Purpose	PT + earthing	PT+lightning arrester	Electric transducer	Electric transducer
	Remarks				

ASN series AC metal-enclosed switchgear and controlgear

Primary wiring scheme of ASN1-40.5 switchgear

Scheme No.		33	34	35	36
Drawing of primary wiring scheme					
Primary element	Rated current of main busbar (A)	630 ~ 3150	630 ~ 3150	630 ~ 3150	630 ~ 3150
	Vacuum circuit breaker/isolation handcart	1	1	1	1
	Current transformer				
	Voltage transformer				
	High-voltage fuse				
	Earthing switch		1		1
	Lightning arrester		3		3
	Live display device	As required by user	As required by user	As required by user	As required by user
	Purpose	Isolation	Isolation	Isolation	Isolation
	Remarks				

Typical primary scheme (1)

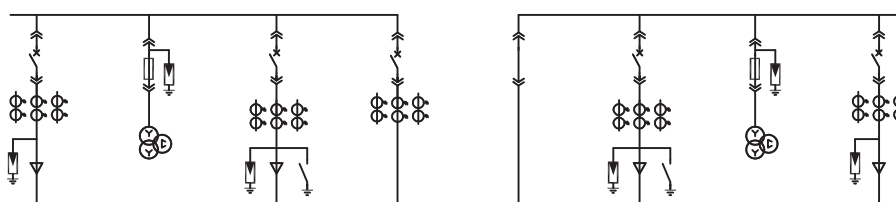

Typical primary scheme (2)

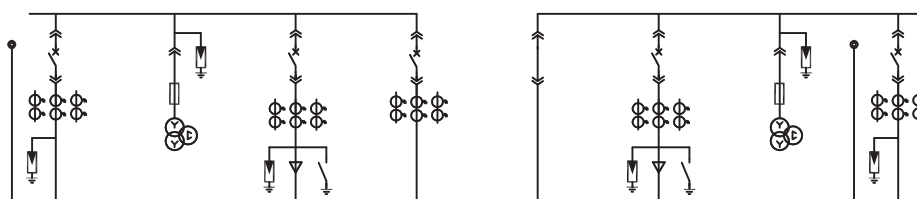

ASN series AC metal-enclosed switchgear and controlgear

Primary wiring scheme of ASN2-24 switchgear

Scheme No.

Drawing of primary wiring scheme

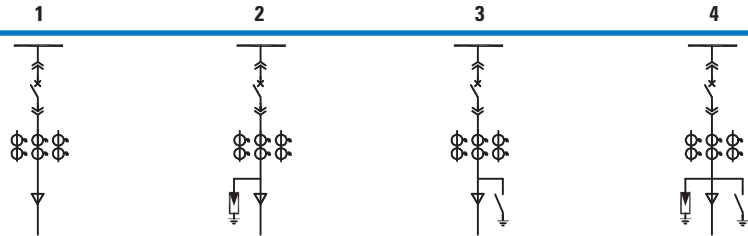

Primary element	Rated current of main busbar (A)	630 ~ 4000	630 ~ 4000	630 ~ 4000	630 ~ 4000
	Vacuum circuit breaker/isolation handcart	1	1	1	1
	Current transformer	3	3	3	3
	Voltage transformer				
	High-voltage fuse				
	Earthing switch			1	1
	Lightning arrester		3		3
	Live display device	As required by user	As required by user	As required by user	As required by user
	Purpose	Cable inlet and outlet line	Cable inlet and outlet line	Cable inlet and outlet line	Cable inlet and outlet line + PT
	Remarks				

Scheme No.

Drawing of primary wiring scheme

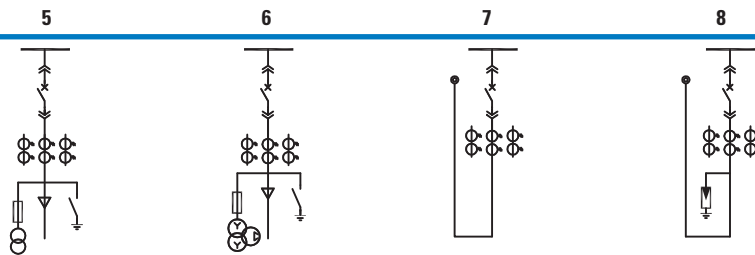

Primary element	Rated current of main busbar (A)	630 ~ 4000	630 ~ 4000	630 ~ 4000	630 ~ 4000
	Vacuum circuit breaker/isolation handcart	1	1	1	1
	Current transformer	3	3	3	3
	Voltage transformer	2	3		
	High-voltage fuse	3	3		
	Earthing switch	1	1		
	Lightning arrester				3
	Live display device	As required by user	As required by user	As required by user	As required by user
	Purpose	Cable inlet and outlet line + PT	Cable inlet and outlet line + PT	Overhead inlet-outlet line	Overhead inlet-outlet line
	Remarks				

ASN series AC metal-enclosed switchgear and controlgear

Primary wiring scheme of ASN2-24 switchgear

Scheme No.

Drawing of primary wiring scheme

		9	10	11	12
Primary element	Rated current of main busbar (A)	630 ~ 4000	630 ~ 4000	630 ~ 4000	630 ~ 4000
	Vacuum circuit breaker/isolation handcart	1	1	1	1
	Current transformer	3	3	3	3
	Voltage transformer			2	3
	High-voltage fuse			3	3
	Earthing switch	1	1		
	Lightning arrester		3		3
	Live display device	As required by user	As required by user	As required by user	As required by user
	Purpose	Overhead inlet-outlet line	Overhead inlet-outlet line	Overhead inlet-outlet line +PT	Overhead inlet-outlet line +PT
	Remarks				

Scheme No.

Drawing of primary wiring scheme

		13	14	15	16
Primary element	Rated current of main busbar (A)	630 ~ 4000	630 ~ 4000	630 ~ 4000	630 ~ 4000
	Vacuum circuit breaker/isolation handcart	1	1	1	1
	Current transformer	3	3	3	
	Voltage transformer				
	High-voltage fuse				
	Earthing switch				
	Lightning arrester		3		
	Live display device	As required by user	As required by user	As required by user	As required by user
	Purpose	Bus coupler circuit breaker	Bus coupler circuit breaker	Bus coupler isolation	Bus coupler isolation
	Remarks				

ASN series AC metal-enclosed switchgear and controlgear

Primary wiring scheme of ASN2-24 switchgear

Scheme No.

Drawing of primary wiring scheme

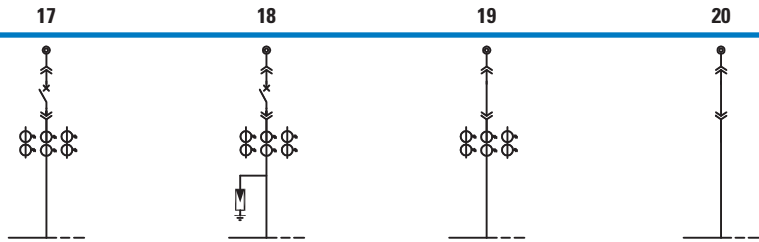

Primary element	Rated current of main busbar (A)	630 ~ 4000	630 ~ 4000	630 ~ 4000	630 ~ 4000
	Vacuum circuit breaker/isolation handcart	1	1	1	1
	Current transformer	3	3	3	
	Voltage transformer				
	High-voltage fuse				
	Earthing switch				
	Lightning arrester		3		
	Live display device	As required by user	As required by user	As required by user	As required by user
	Purpose	Overhead inlet line + contact	Overhead inlet line + contact	Overhead inlet line + isolation	Overhead inlet line + isolation
	Remarks				

Scheme No.

Drawing of primary wiring scheme

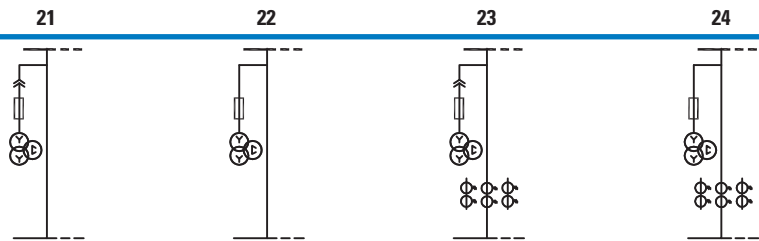

Primary element	Rated current of main busbar (A)	630 ~ 4000	630 ~ 4000	630 ~ 4000	630 ~ 4000
	Vacuum circuit breaker/isolation handcart	1		1	
	Current transformer			3	3
	Voltage transformer	3	3	3	3
	High-voltage fuse	3	3	3	3
	Earthing switch				
	Lightning arrester				
	Live display device	As required by user	As required by user	As required by user	As required by user
	Purpose	Bus coupler + PT	Bus coupler + PT	Measurement	Measurement
	Remarks				

ASN series AC metal-enclosed switchgear and controlgear

Primary wiring scheme of ASN2-24 switchgear

Scheme No.

Drawing of primary wiring scheme

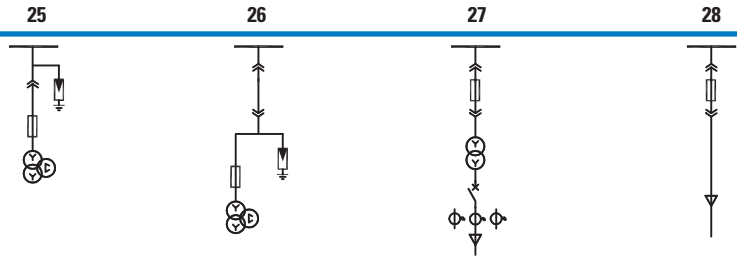

Primary element	Rated current of main busbar (A)	630 ~ 4000	630 ~ 4000	630 ~ 4000	630 ~ 4000
	Vacuum circuit breaker/isolation handcart	1	1	1	1
	Current transformer			3	
	Voltage transformer	3	3	1	
	High-voltage fuse	3	3	3	3
	Earthing switch				
	Lightning arrester	3	3		
	Live display device	As required by user	As required by user	As required by user	As required by user
	Purpose	PT + lightning arrester	PT + lightning arrester	Electric transducer	Electric transducer
	Remarks				

Typical primary scheme (1)

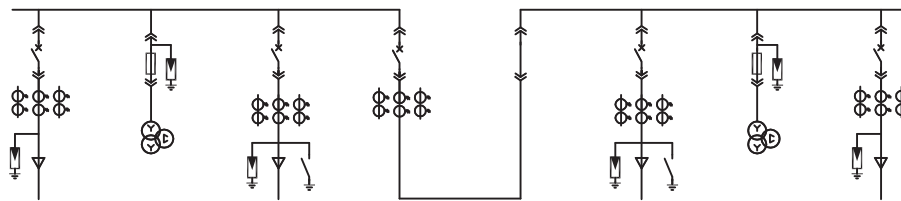

Typical primary scheme (2)

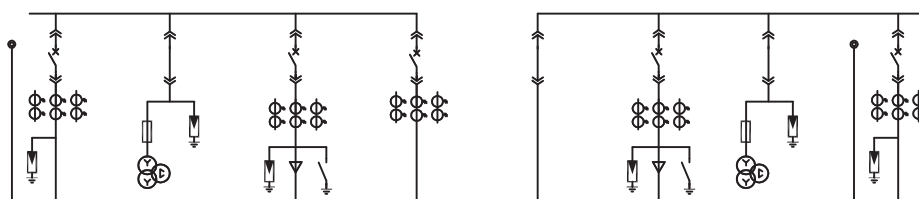

ASN series AC metal-enclosed switchgear and controlgear

Primary wiring scheme of ASN3-12 switchgear

Scheme No.

Drawing of primary wiring scheme

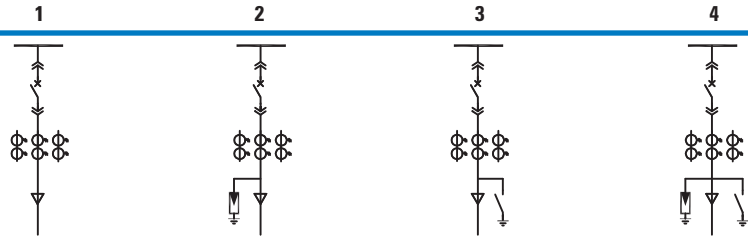

Primary element	Rated current of main busbar (A)	630 ~ 5000	630 ~ 5000	630 ~ 5000	630 ~ 5000
	Vacuum circuit breaker/isolation handcart	1	1	1	1
	Current transformer	3	3	3	3
	Voltage transformer				
	High-voltage fuse				
	Earthing switch			1	1
	Lightning arrester		3		3
	Live display device	As required by user	As required by user	As required by user	As required by user
	Purpose	Cable inlet and outlet line	Cable inlet and outlet line	Cable inlet and outlet line	Cable inlet and outlet line + PT
	Remarks				

Scheme No.

Drawing of primary wiring scheme

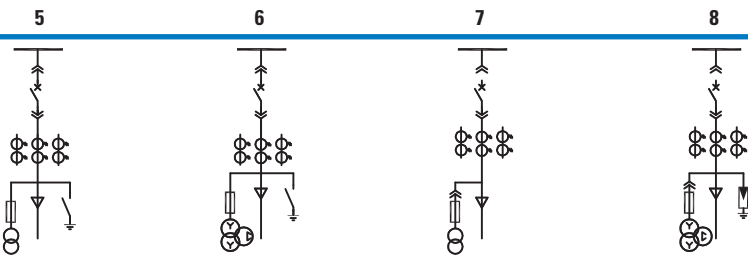

Primary element	Rated current of main busbar (A)	630 ~ 5000	630 ~ 5000	630 ~ 5000	630 ~ 5000
	Vacuum circuit breaker/isolation handcart	1	1	1	1
	Current transformer	3	3	3	3
	Voltage transformer	2	3	2	3
	High-voltage fuse	3	3	3	3
	Earthing switch	1	1		
	Lightning arrester				3
	Live display device	As required by user	As required by user	As required by user	As required by user
	Purpose	Cable inlet and outlet line + PT	Cable inlet and outlet line + PT	Cable inlet-outlet line +PT	Cable inlet-outlet line +PT
	Remarks				

ASN series AC metal-enclosed switchgear and controlgear

Primary wiring scheme of ASN3-12 switchgear

Scheme No.

Drawing of primary wiring scheme

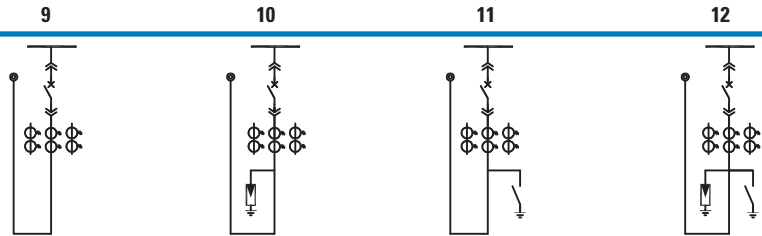

Primary element	Rated current of main busbar (A)	630 ~ 5000	630 ~ 5000	630 ~ 5000	630 ~ 5000
	Vacuum circuit breaker/isolation handcart	1	1	1	1
	Current transformer	3	3	3	3
	Voltage transformer				
	High-voltage fuse				
	Earthing switch			1	1
	Lightning arrester		3		3
	Live display device	As required by user	As required by user	As required by user	As required by user
	Purpose	Overhead inlet-outlet line	Overhead inlet-outlet line	Overhead inlet-outlet line	Overhead inlet-outlet line
	Remarks				

Scheme No.

Drawing of primary wiring scheme

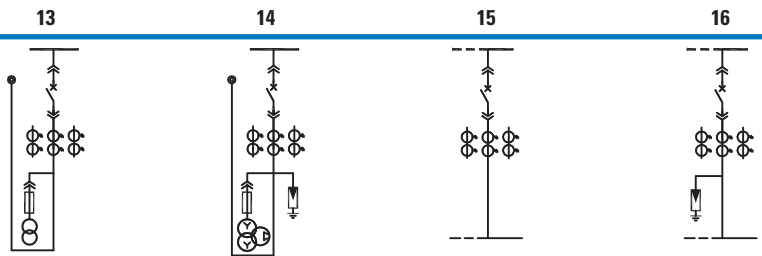

Primary element	Rated current of main busbar (A)	630 ~ 5000	630 ~ 5000	630 ~ 5000	630 ~ 5000
	Vacuum circuit breaker/isolation handcart	1	1	1	1
	Current transformer	3	3	3	3
	Voltage transformer	2	3		
	High-voltage fuse	3	3		
	Earthing switch				
	Lightning arrester		3		3
	Live display device	As required by user	As required by user	As required by user	As required by user
	Purpose	Overhead inlet-outlet line+PT	Overhead inlet-outlet line+PT	Bus coupler circuit breaker	Bus coupler circuit breaker
	Remarks				

ASN series AC metal-enclosed switchgear and controlgear

Primary wiring scheme of ASN3-12 switchgear

Scheme No.

Drawing of primary wiring scheme

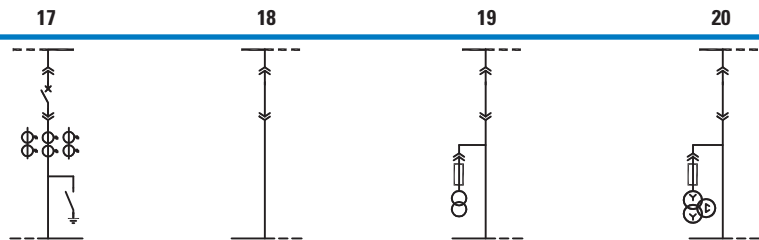

Primary element	Rated current of main busbar (A)	630 ~ 5000	630 ~ 5000	630 ~ 5000	630 ~ 5000
	Vacuum circuit breaker/isolation handcart		1	1	1
	Current transformer	3			
	Voltage transformer			2	3
	High-voltage fuse			3	3
	Earthing switch	1			
	Lightning arrester				
	Live display device	As required by user	As required by user	As required by user	As required by user
	Purpose	Bus coupler circuit breaker	Bus coupler isolation	Bus coupler isolation + PT	Bus coupler isolation + PT
	Remarks				

Scheme No.

Drawing of primary wiring scheme

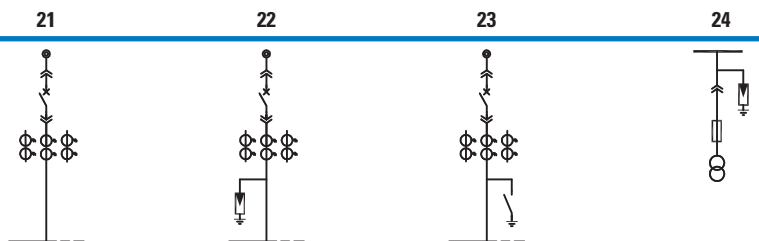

Primary element	Rated current of main busbar (A)	630 ~ 5000	630 ~ 5000	630 ~ 5000	630 ~ 5000
	Vacuum circuit breaker/isolation handcart	1	1	1	
	Current transformer	3	3	3	
	Voltage transformer				2
	High-voltage fuse				3
	Earthing switch			1	
	Lightning arrester		3		3
	Live display device	As required by user	As required by user	As required by user	As required by user
	Purpose	Overhead inlet line + contact	Overhead inlet line + contact	Overhead inlet line + contact	PT
	Remarks				

ASN series AC metal-enclosed switchgear and controlgear

Primary wiring scheme of ASN3-12 switchgear

Scheme No.

Drawing of primary wiring scheme

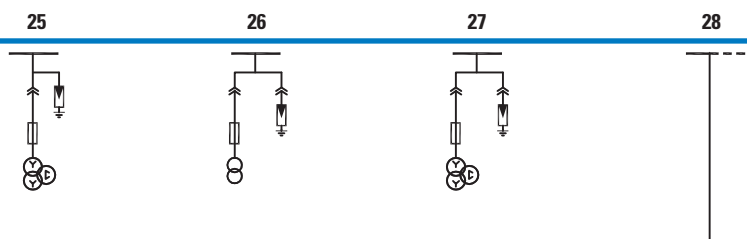

Primary element	25	26	27	28
Rated current of main busbar (A)	630 ~ 5000	630 ~ 5000	630 ~ 5000	630 ~ 5000
Vacuum circuit breaker/isolation handcart				
Current transformer				
Voltage transformer	3	2	3	
High-voltage fuse	3	3	3	
Earthing switch				
Lightning arrester	3	3	3	
Live display device	As required by user	As required by user	As required by user	As required by user
Purpose	PT	PT+lightning arrester	PT+lightning arrester	Bus coupler
Remarks				

Scheme No.

Drawing of primary wiring scheme

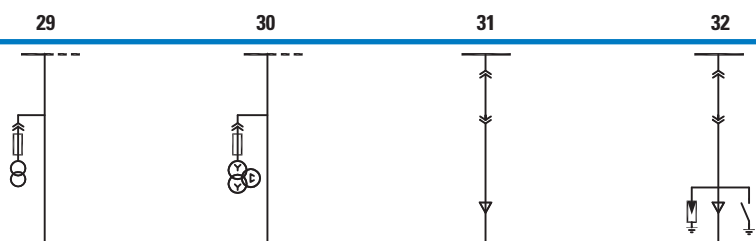

Primary element	29	30	31	32
Rated current of main busbar (A)	630 ~ 5000	630 ~ 5000	630 ~ 5000	630 ~ 5000
Vacuum circuit breaker/isolation handcart	1	1	1	1
Current transformer				
Voltage transformer	2	3		
High-voltage fuse	3	3		
Earthing switch				1
Lightning arrester				3
Live display device	As required by user	As required by user	As required by user	As required by user
Purpose	Bus coupler+PT	Bus coupler+PT	Isolation	Isolation
Remarks				

ASN series AC metal-enclosed switchgear and controlgear

Primary wiring scheme of ASN3-12 switchgear

Scheme No.

Drawing of primary wiring scheme

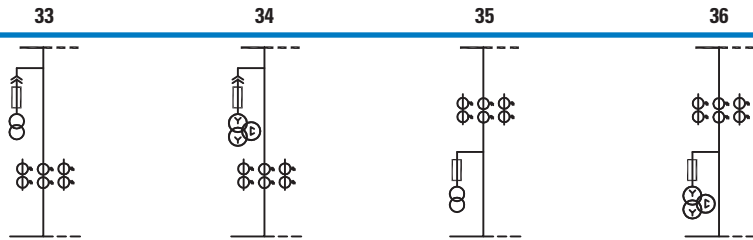

Primary element	33	34	35	36
Rated current of main busbar (A)	630 ~ 5000	630 ~ 5000	630 ~ 5000	630 ~ 5000
Vacuum circuit breaker/isolation handcart				
Current transformer	3	3	3	3
Voltage transformer	2	3	2	3
High-voltage fuse	3	3	3	3
Earthing switch				
Lightning arrester				
Live display device	As required by user	As required by user	As required by user	As required by user
Purpose	Measurement + contact	Measurement + contact	Measurement + contact	Measurement + contact
Remarks				

Typical primary scheme (1)

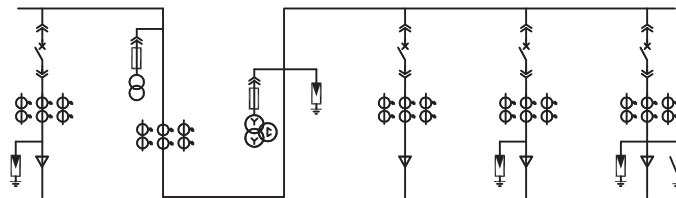

Typical primary scheme (2)

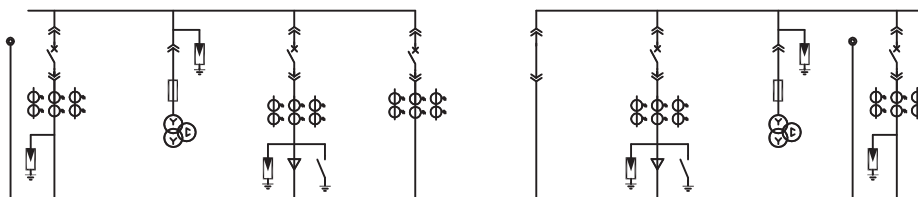

ASN series AC metal-enclosed switchgear and controlgear

External dimensions and mounting base drawing

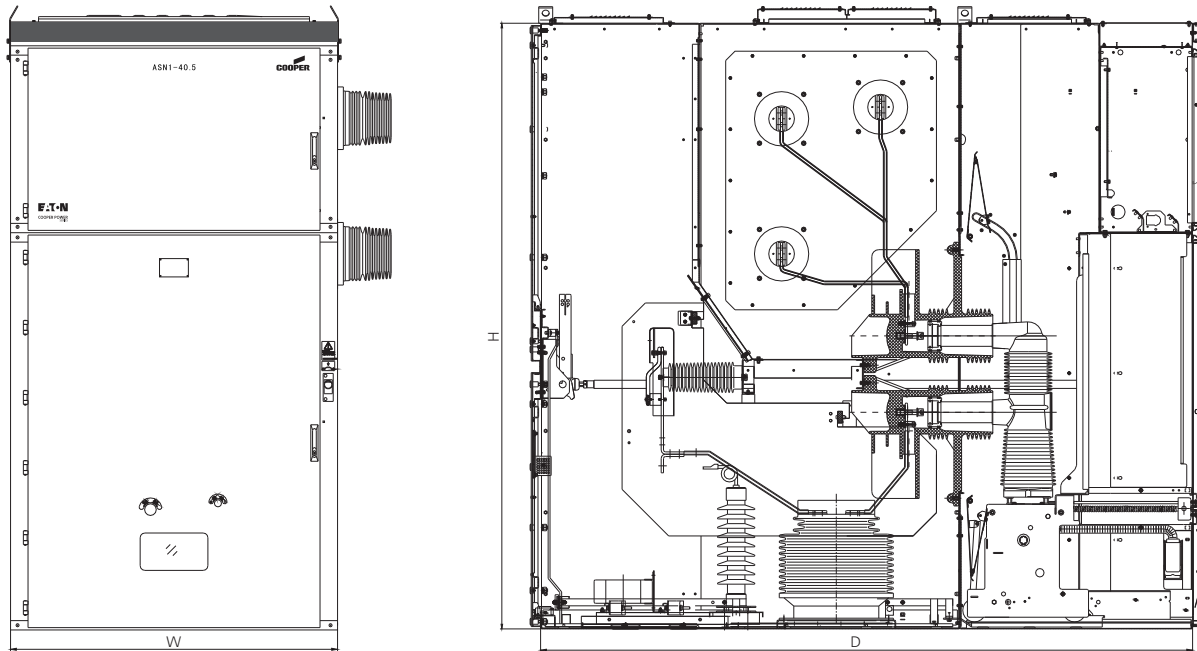

Drawing of ASN1 switchgear dimensions and structure

Item	Unit	Parameters	
Height (H)	mm	2400	2600
Width (W)	mm	1200	1400
Depth (D)	mm	2600	2800
Weight	kg	850-1850	850-1850

ASN series AC metal-enclosed switchgear and controlgear

External dimensions and mounting base drawing

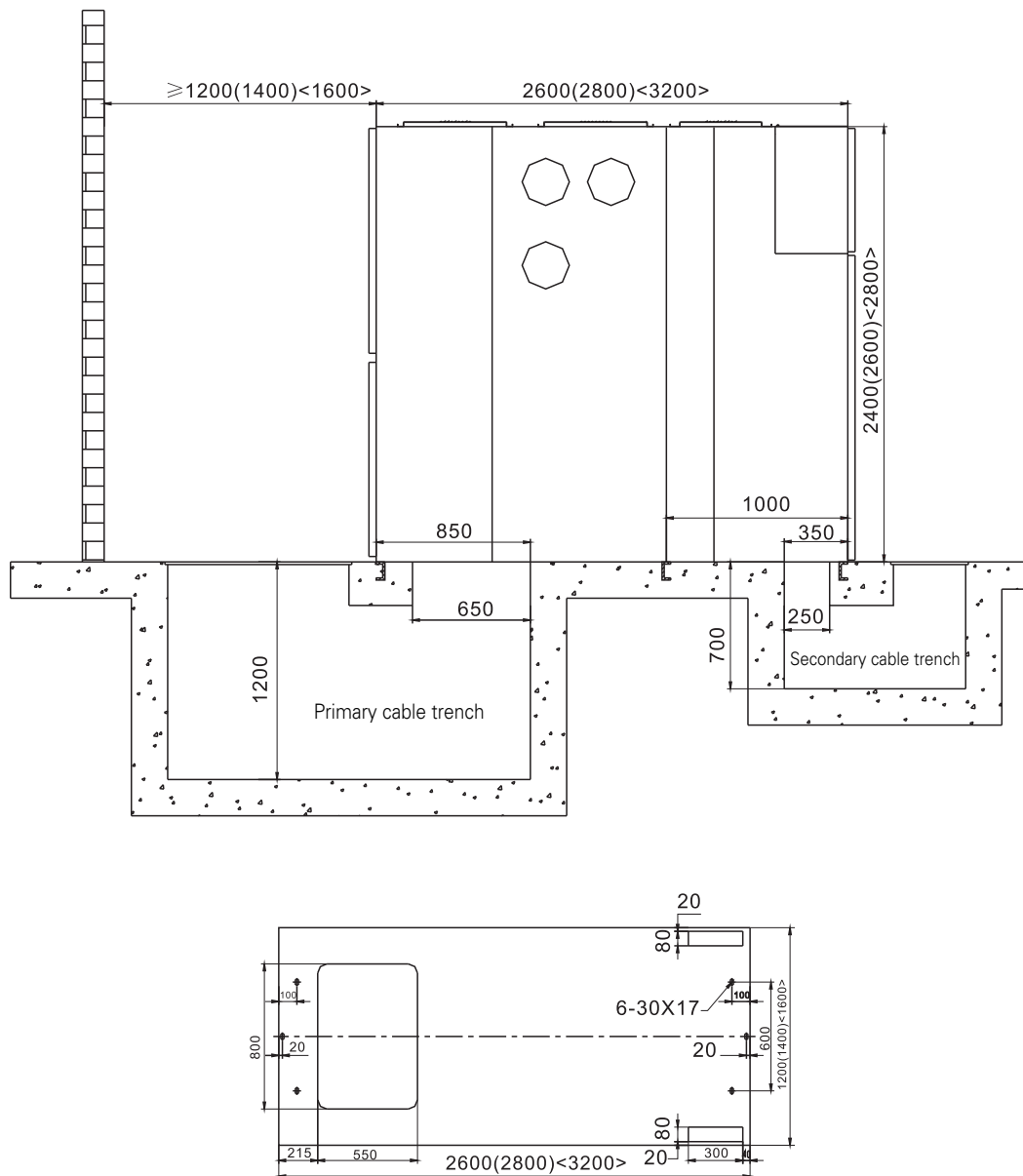

Drawing of installation foundation and sizes of holes of bottom plate for ASN1 switchgear

ASN series AC metal-enclosed switchgear and controlgear

External dimensions and mounting base drawing

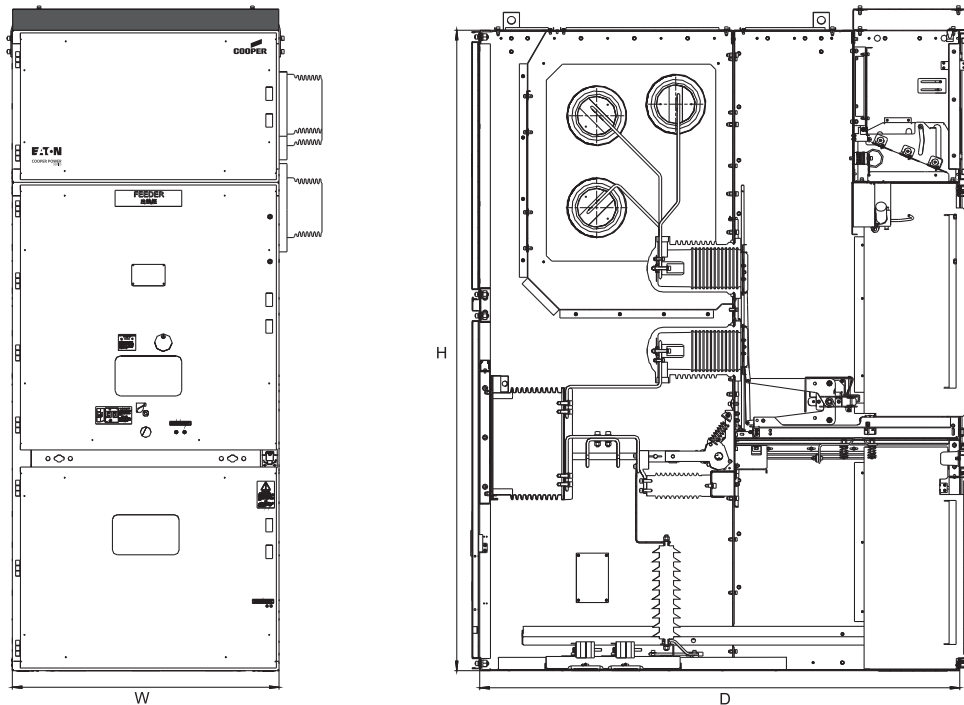

Drawing of ASN2 switchgear dimensions and structure

Item		Unit	Parameters
Height (H)		mm	2400
Width (W)	Rated current of branch bus is 1250A and below	mm	800 (1000 optional)
	Rated current of Branch bus is 1600A and above	mm	1000
Depth (D) ^①		mm	1800
Weight		kg	840~1440

^① Depth of overhead inlet and outlet cabinet is 2300mm.

ASN series AC metal-enclosed switchgear and controlgear

External dimensions and mounting base drawing

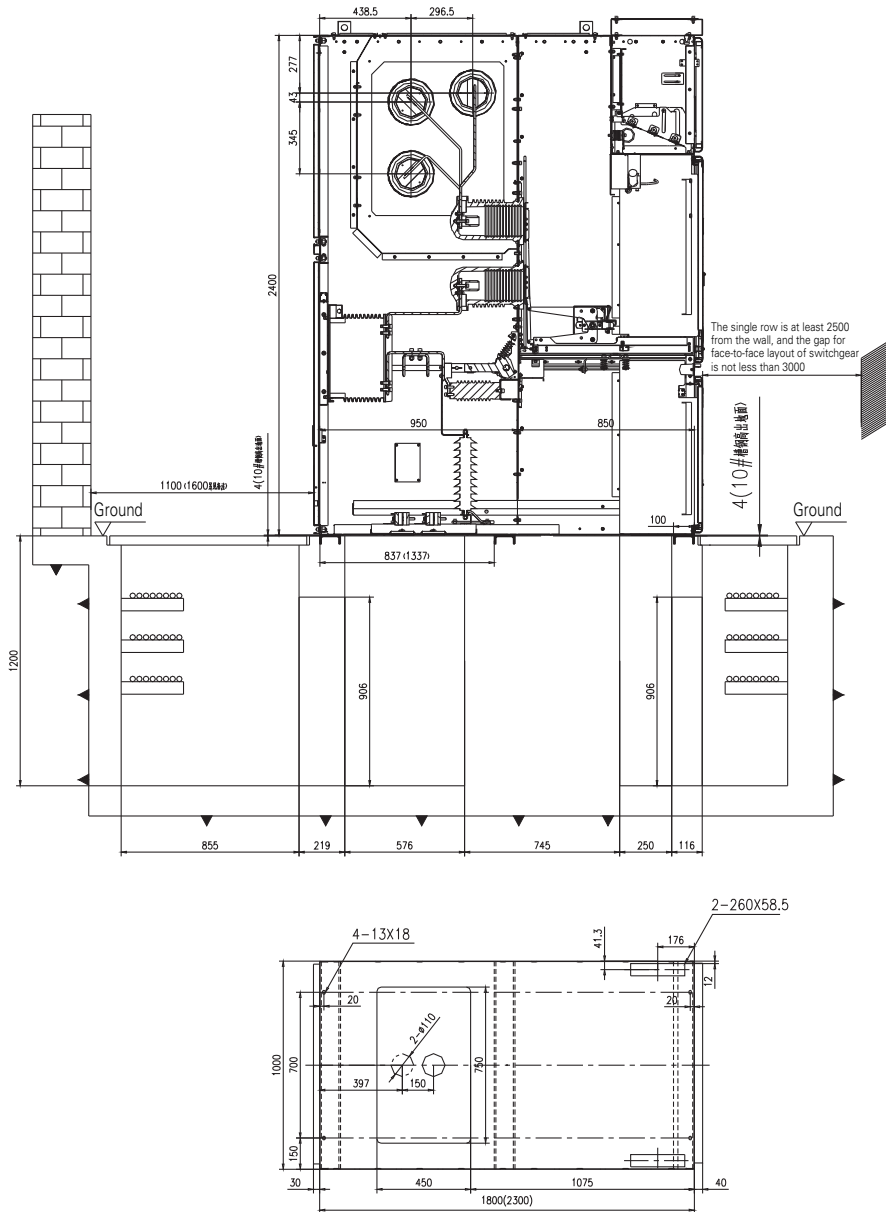

Drawing of installation foundation and sizes of holes of bottom plate for ASN2 switchgear
(remarks: these sizes can vary according to other schemes)

ASN series AC metal-enclosed switchgear and controlgear

External dimensions and mounting base drawing

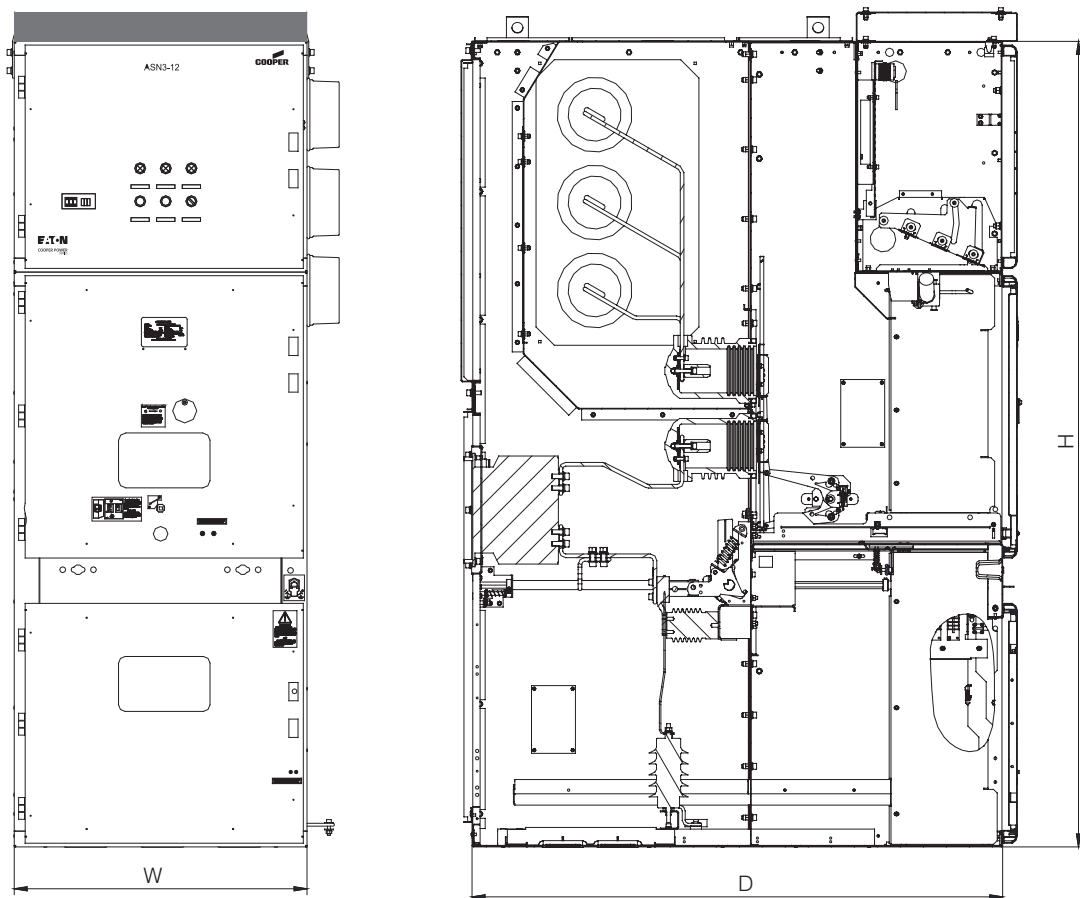

Drawing of ASN3 switchgear dimensions and structure

Item		Unit	Parameters
Height (H)		mm	2200
Width (W)	Rated current of branch bus is 1250A and below and the thermal stability current is 31.5kA and below	mm	800 (550, 650 optional)
	Rated current of branch bus is 1250A and below and the thermal stability current is 40kA and 50kA	mm	800
	Rated current of branch bus is 1600A or 2000A	mm	1000 (800 optional)
	Rated current of branch busbar is 2500A and above	mm	1000
Depth (D) ^①		mm	1450
Weight		kg	700~1200

^① Depth of overhead inlet and outlet cabinet is 1750mm.

ASN series AC metal-enclosed switchgear and controlgear

External dimensions and mounting base drawing

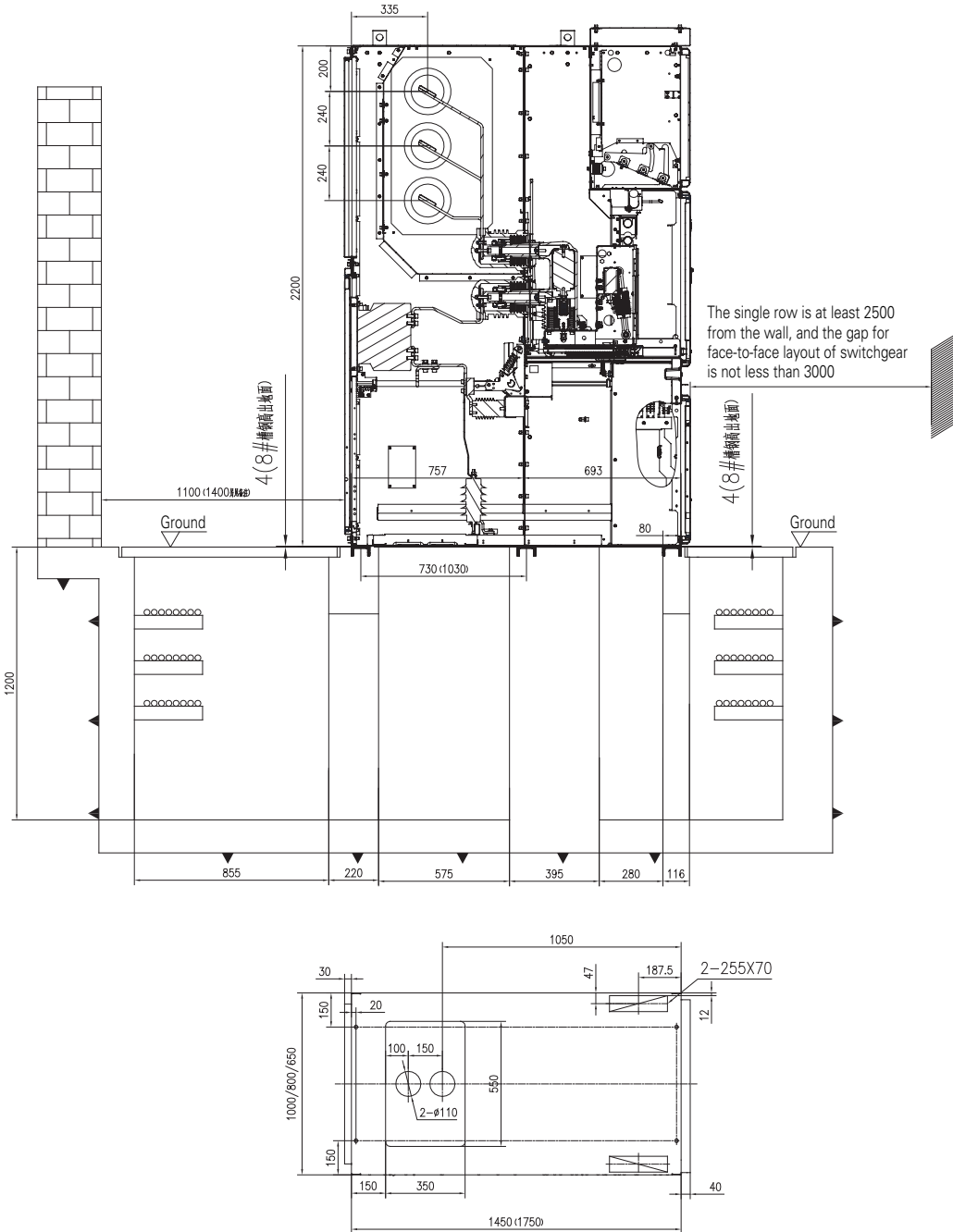

Drawing of installation foundation and sizes of holes of bottom plate for ASN3 switchgear

Eaton is a power management company with 2016 sales of \$19.7 billion. Eaton provides energy-efficient solutions that help our customers effectively manage electrical, hydraulic and mechanical power more efficiently, safely and sustainably. Eaton has approximately 95,000 employees and sells products to customers in more than 175 countries. For more information, visit www.eaton.com.

Electrical Sector Asia Pacific
No.3, Lane 280, Linhong Road,
Changning District, Shanghai

Cooper (Ningbo) Electric Co., Ltd.
No.439,2nd Binhai Road ,
New Hangzhou Bay Zone,
Ningbo Zhejiang

© 2017 Eaton Corporation
All Rights Reserved
Printed in China
February 2017



Mobile WeChat



WeChat public platform