

## UltraSIL™ Polymer-Housed VariSTAR™ Type US, UH, and UX Station-Class Surge Arresters Installation and Maintenance Instructions



*Powering Business Worldwide*

## **DISCLAIMER OF WARRANTIES AND LIMITATION OF LIABILITY**

The information, recommendations, descriptions and safety notations in this document are based on Eaton Corporation's ("Eaton") experience and judgment and may not cover all contingencies. If further information is required, an Eaton sales office should be consulted. Sale of the product shown in this literature is subject to the terms and conditions outlined in appropriate Eaton selling policies or other contractual agreement between Eaton and the purchaser.

THERE ARE NO UNDERSTANDINGS, AGREEMENTS, WARRANTIES, EXPRESSED OR IMPLIED, INCLUDING WARRANTIES OF FITNESS FOR A PARTICULAR PURPOSE OR MERCHANTABILITY, OTHER THAN THOSE SPECIFICALLY SET OUT IN ANY EXISTING CONTRACT BETWEEN THE PARTIES. ANY SUCH CONTRACT STATES THE ENTIRE OBLIGATION OF EATON. THE CONTENTS OF THIS DOCUMENT SHALL NOT BECOME PART OF OR MODIFY ANY CONTRACT BETWEEN THE PARTIES.

In no event will Eaton be responsible to the purchaser or user in contract, in tort (including negligence), strict liability or otherwise for any special, indirect, incidental or consequential damage or loss whatsoever, including but not limited to damage or loss of use of equipment, plant or power system, cost of capital, loss of power, additional expenses in the use of existing power facilities, or claims against the purchaser or user by its customers resulting from the use of the information, recommendations and descriptions contained herein. The information contained in this manual is subject to change without notice.

# Contents

<b>DISCLAIMER OF WARRANTIES AND LIMITATION OF LIABILITY</b> .....	<b>ii</b>
<b>SAFETY FOR LIFE</b> .....	<b>iv</b>
<b>SAFETY INFORMATION</b> .....	<b>iv</b>
Safety instructions .....	iv
<b>PRODUCT INFORMATION</b> .....	<b>1</b>
Introduction .....	1
Acceptance and initial inspection .....	1
Handling and storage .....	1
Quality standards .....	1
<b>GENERAL APPLICATION RECOMMENDATIONS</b> .....	<b>1</b>
Identification .....	1
Lifting instructions .....	2
Grading ring .....	2
<b>INSTALLATION INSTRUCTIONS</b> .....	<b>3</b>
Arresters 3 kV through 120 kV .....	3
Arresters 132 kV through 240 kV or housing codes greater than 60 .....	3
Bracket or Structure Mounting .....	6
Suspension Mounting .....	6
Horizontal Mounting .....	6
<b>ELECTRICAL CONNECTIONS</b> .....	<b>8</b>
Line Terminal Connector .....	8
Ground Terminal Connector .....	8
<b>MAINTENANCE</b> .....	<b>8</b>
<b>ADDITIONAL INFORMATION</b> .....	<b>8</b>



## Safety for life



Eaton meets or exceeds all applicable industry standards relating to product safety in its Cooper Power™ series products. We actively promote safe practices in the use and maintenance of our products through our service literature, instructional training programs, and the continuous efforts of all Eaton employees involved in product design, manufacture, marketing, and service.

We strongly urge that you always follow all locally approved safety procedures and safety instructions when working around high voltage lines and equipment, and support our “Safety For Life” mission.

## Safety information

The instructions in this manual are not intended as a substitute for proper training or adequate experience in the safe operation of the equipment described. Only competent technicians who are familiar with this equipment should install, operate, and service it.

A competent technician has these qualifications:

- Is thoroughly familiar with these instructions.
- Is trained in industry-accepted high and low-voltage safe operating practices and procedures.
- Is trained and authorized to energize, de-energize, clear, and ground power distribution equipment.
- Is trained in the care and use of protective equipment such as arc flash clothing, safety glasses, face shield, hard hat, rubber gloves, clampstick, hotstick, etc.

Following is important safety information. For safe installation and operation of this equipment, be sure to read and understand all cautions and warnings.

### Hazard Statement Definitions

This manual may contain four types of hazard statements:

---

**DANGER**

---

**Indicates an imminently hazardous situation which, if not avoided, will result in death or serious injury.**

---

**WARNING**

---

**Indicates a potentially hazardous situation which, if not avoided, could result in death or serious injury.**

---

**CAUTION**

---

**Indicates a potentially hazardous situation which, if not avoided, may result in minor or moderate injury.**

---

**CAUTION**

---

**Indicates a potentially hazardous situation which, if not avoided, may result in equipment damage only.**

---

### Safety instructions

Following are general caution and warning statements that apply to this equipment. Additional statements, related to specific tasks and procedures, are located throughout the manual.

---

**DANGER**

---

**Hazardous voltage. Contact with hazardous voltage will cause death or severe personal injury. Follow all locally approved safety procedures when working around high- and low-voltage lines and equipment.**

G103.3

---

**WARNING**

---

**Before installing, operating, maintaining, or testing this equipment, carefully read and understand the contents of this manual. Improper operation, handling or maintenance can result in death, severe personal injury, and equipment damage.**

G101.0

---

**WARNING**

---

**This equipment is not intended to protect human life. Follow all locally approved procedures and safety practices when installing or operating this equipment. Failure to comply can result in death, severe personal injury and equipment damage.**

G102.1

---

**WARNING**

---

**Power distribution and transmission equipment must be properly selected for the intended application. It must be installed and serviced by competent personnel who have been trained and understand proper safety procedures. These instructions are written for such personnel and are not a substitute for adequate training and experience in safety procedures. Failure to properly select, install or maintain power distribution and transmission equipment can result in death, severe personal injury, and equipment damage.**

G122.2

---

**CAUTION**

---

Eaton's Cooper Power series UltraSIL Polymer-Housed VariSTAR Type US, UH, and UX Station-Class Surge Arresters are designed to be operated in accordance with safe operating procedures. These instructions are not intended to supersede or replace proper safety and operating procedures. Read all instructions before installing the arrester.

Surge arresters should be installed and serviced only by personnel familiar with good safety practice and the handling of high-voltage electrical equipment.

---

## Product information

### Introduction

The UltraSIL™ Polymer-Housed Type US, UH, UX VariSTAR™ Station-Class Surge Arresters incorporate the latest in metal oxide varistor (MOV) technology. These arresters are constructed of a single series column of MOV disks. They are used for overvoltage protection of high voltage equipment, either indoors or outdoors. These arresters are designed and tested to meet or exceed the requirements set forth in IEEE Std C62.11™ -2005 standard. The Short Circuit Test is performed in accordance with IEEE Std C62.11a™-2008 standard.

### Read this manual first

Read and understand the contents of this manual and follow all locally approved procedures and safety practices before installing or operating this equipment.

### Additional information

These instructions cannot cover all details or variations in the equipment, procedures, or process described nor provide directions for meeting every possible contingency during installation, operation, or maintenance. When additional information is desired to satisfy a problem not covered sufficiently for the user's purpose, please contact your Eaton's Cooper Power series product sales representative.

### Acceptance and initial inspection

The factory takes special precautions to ship the arresters in well-designed containers that reduce the possibility of damage, which may occur during transit. Carefully inspect each arrester for physical damage. In case of improper handling or shipping damage, immediately file a claim with the carrier and promptly notify Eaton or your local representative.

---

**CAUTION**

---

Do not attempt to install arresters that have evidence of damage.

---

### Handling and storage

If the arrester is to be stored for an appreciable time before installation, provide a clean, dry storage area. Locate the arrester so as to minimize the possibility of physical damage.

### Quality standards

ISO 9001 Certified Quality Management System

## General application recommendations

Eaton's Cooper Power series product application engineers are available to make specific application recommendations.

### Identification

A nameplate attached to the base of each arrester indicates its catalog number, voltage rating, maximum continuous operating voltage (MCOV), rated frequency, pressure-relief current rating, class, reference to the type test standard, altitude range, serial number, and year of manufacture. Refer to Figure 1 for an example of a blank nameplate.

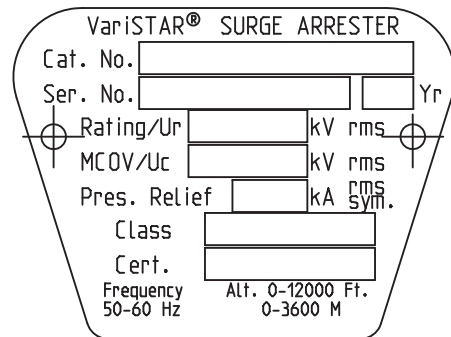
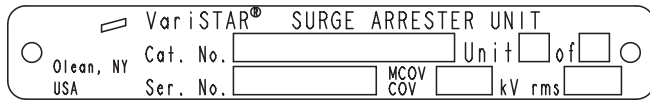

Figure 1. Detail of blank unit nameplate on arrester base

# UltraSIL™ Polymer-Housed VariSTAR™ Type US, UH, and UX Station-Class Surge Arresters



**Figure 2. Detail of blank arrester nameplate**

For multi-unit arresters rated above 120 kV or housing codes above 60 an additional nameplate is provided on the base that includes information regarding the catalog number, serial number, unit identification, and unit MCOV. Refer to Figure 2. Information regarding unit identification is etched on a unit nameplate located on the arrester flange assembly for each arrester section.

---

**⚠ CAUTION**

---

**Always handle surge arresters carefully. A damaged arrester may cause catastrophic failure upon energization.**

---

### Lifting instructions

All UltraSIL Type US, UH, or UX Arresters must be lifted vertically by the line terminal. Use of a lifting strap (user supplied) is recommended. Refer to Figure 3 for detailed lifting instructions.

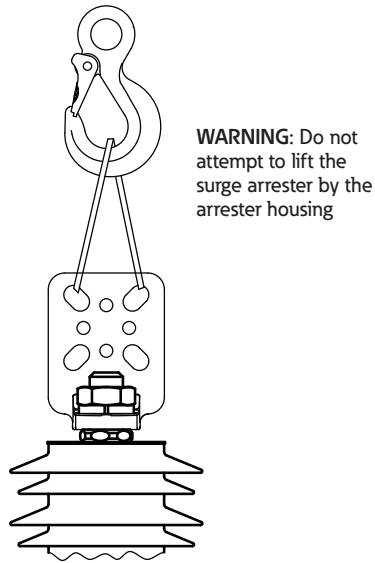

**Figure 3. Detail of recommended lifting instructions**

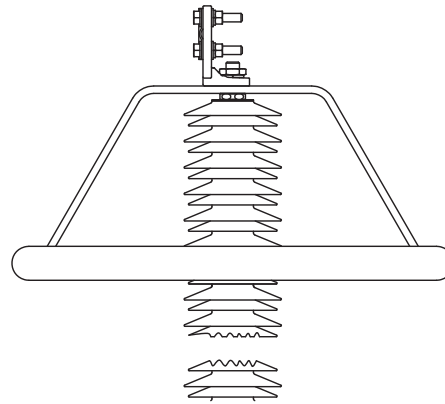

**Figure 4. Detail of grading ring placement**

---

**⚠ WARNING**

---

**Use only the grading ring supplied with the arrester. No other manufacturer's grading ring can be substituted.**

---

### Grading ring

Arrester ratings from 132 kV through 240 kV (housing codes greater than 60) will be supplied with a grading ring. When a grading ring is supplied, it must be placed on the arrester to guarantee correct operating performance. Refer to Figure 4 for correct placement of the grading ring.

## Installation instructions

### Arresters 3 kV through 120 kV

UltraSIL Type US, UH, and UX Arresters are shipped assembled for ratings 3 kV through 120 kV (or housing codes 60 or less). For these arresters choose a permanent installation location so that the arresters will be installed as close as possible (electrically) to the equipment being protected. Minimum clearance distances between any line potential surface to an arrester, and to any ground plane are listed in Table 1. Figure 6 shows the minimum phase-to-ground and minimum phase-to-phase clearances. Refer to Table 1 and Figure 8 for standard arrester dimension and weight information.

### Packaged components (3-120 kV rated)

- Assembled arrester ready for installation.
- The line and ground terminal connectors are shipped unattached in the box, and should be assembled after the arrester is installed.

### Detailed assembly instructions

1. After the arrester is in place and ready to be secured, the ground terminal connector should be placed so that the mounting hole, found on the connector, is directly over one of the three mounting slots on the base of the arrester.
2. The bolt (user-supplied) used to secure the arrester is then run through the hole of the connector, the mounting slot, and the structure the arrester is attached to.
3. Secure the arrester to the structure with the hex nuts (user-supplied).
4. Position the line terminal connector on the top of the arrester. Secure the supplied lock washer and nut until tight.

**Note:** The recommended minimum torque level for the 20 mm or 1.0" terminal nut is 100 ft-lbs.

The recommended minimum torque level for the terminal clamp hardware is 30 ft-lbs.

The recommended maximum torque level for the eyebolt connector clamping nut is 20 ft-lbs.

### Arresters 132 kV through 240 kV or housing codes greater than 60

UltraSIL Type US, UH Arresters are shipped unassembled for ratings 132 kV through 240 kV (housing codes greater than 60). These arresters are also supplied with a grading ring, that is packaged with the arrester and is illustrated in Figure 5. For these arresters choose a permanent installation location so that arresters will be installed as close as possible (electrically) to the equipment being protected. Minimum clearance distances between any line

potential surface to an arrester and to any ground plane are listed in Table 1. Figure 6 shows the minimum phase-to-ground and minimum phase-to-phase clearances. Refer to Table 1 and Figure 8 for standard arrester dimension and weight information.

Multi-unit arresters must be erected with the units in the correct order as shown in Figure 5. All units in a multi-unit arrester have the same serial number and are marked with the appropriate unit number. Refer to the unit nameplate on the base of the arrester for the correct placement order.

### Packaged components (132-240 kV rated)

**Unit A** Arrester identified as unit 1 of 2 on the unit nameplate located on the flange connector and with mounting base attached.

**Unit B** Arrester identified as unit 2 of 2 on the unit nameplate located on the flange connector.

A single grading ring is provided for arrester ratings 132 kV through 240 kV. Line and ground terminal connectors and mounting hardware are supplied separately in a bag.

## ⚠ CAUTION

**Do not attempt to remove the large bolt on either end of the arrester. They are an integral to the moisture seal of the arrester. If required, loosen the top bolt to allow orientation of the line terminal connector to the desired position, secure until tight.**

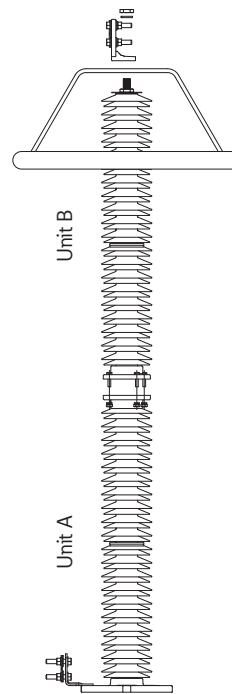
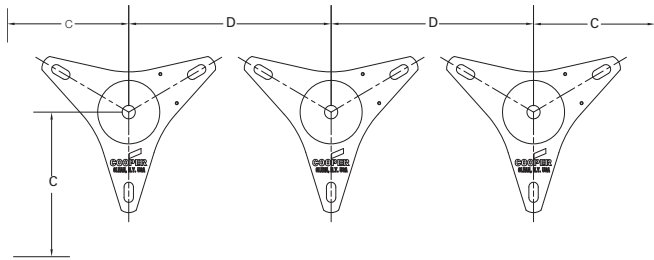

Figure 5. Detail of arrester assembly



**Figure 6. Three-phase in-line mounting arrangement**

**Note:** Refer to Table 1 for Dimensions “C” and “D.”

**Detailed assembly instructions**

Multi-unit arresters can be assembled prior to installation into a permanent location if desired, however, the recommended installation is shown below.

1. After Unit A is in place and ready to be secured, the ground terminal connector should be placed so that the mounting hole, found on the connector, is directly over one of the three mounting slots on the base of the arrester.
2. The bolt (user supplied) used to secure the arrester is then run through the holes of the connector, the mounting slot, and the structure the arrester is attached to.
3. Secure the arrester to the structure with mounting hardware (user supplied).
4. Attach Unit B onto Unit A using four (4) sets of 8 mm hardware, which includes bolts, lock washer and nuts with a **MAXIMUM ALLOWABLE** torque of 15 ft-lbs. Applying too much torque will strip the threads.

**⚠ WARNING**

**Do not attempt to lift an arrester assembly of more than 4 units at one time.**

5. Position the supplied grading ring onto the top unit as shown in Figure 4. Next, situate the line terminal connector followed by the supplied lock washer and nut as shown in Figure 5. Secure until tight.

**Note:** Recommended minimum torque level for the 20 mm or 1.0” terminal nut is 100 ft-lbs.

**⚠ CAUTION**

**While torquing the nut, do not use the grading ring as a support.**

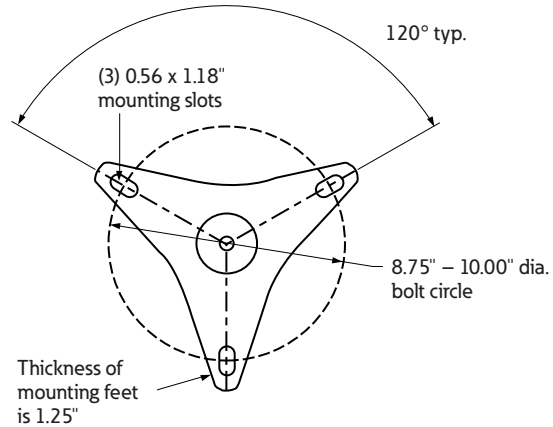

**Figure 7. Mounting base details**

**⚠ CAUTION**

**The values shown in Table 1 are the minimum clearances recommended by Eaton. These minimum clearances may be increased to meet local or system requirements for spacing of energized equipment. Safe operating practices must always be followed.**

**Mechanical Strength**

Type US (3-108 kV) Station-Class Arresters have an ultimate cantilever strength rating of 15,000 in-lbs and a maximum recommended working load rating of 6,000 in-lbs. Type UH (3-108 kV) and Type US (120-240 kV) Station-Class Arresters have an ultimate cantilever strength rating of 20,000 in-lbs and a maximum recommended working load rating of 8,000 in-lbs. Type UX (3-108 kV) and Type UH (120-240 kV) Station-Class Arresters have an ultimate cantilever strength rating of 35,000 in-lbs and a maximum recommended working load rating of 14,000 in-lbs.

In order to achieve rated cantilever strength use a 10” bolt circle mounting diameter and 0.5” hardened bolts with flat washers.

**⚠ CAUTION**

**Make electrical connections so that no mechanical stress is applied to the arrester.**

**Base or Foundation Mounting**

Pier footings should extend below the frost line. Elevate the foundation sufficiently above the ground line for personnel safety and to prevent contamination from ground splash, drifting snow, flood water, or other contaminating conditions. If the top of the foundation is not level, shims will be required for leveling. Layout mounting dimensions for the arrester mounting base are shown in Figure 7.



# UltraSIL™ Polymer-Housed VariSTAR™ Type US, UH, and UX Station-Class Surge Arresters

**Table 1. Dimensions, clearance requirements, and weights of UltraSIL polymer-housed station-class arresters (standard configuration)**

Arrester Rating (kV, rms)	Arrester MCOV (kV, rms)	Figure 8 Dim. "A" (inches)			Figure 8 Dim. "B" (inches)			Figure 6 Dim. "C" Minimum Phase-to-Ground Clearances (inches)*			Figure 6 Dim. "D" Minimum Phase-to-Phase Clearances (inches)*			Weight (lbs.)		
		US	UH	UX	US	UH	UX	US	UH	UX	US	UH	UX	US	UH	UX
3	2.55	8.2	8.2	8.2	5.13	5.49	5.93	5.5	5.5	5.5	10	10	10	8.8	11.0	11.0
6	5.1	9.7	9.7	9.7	5.13	5.49	5.93	5.5	5.5	5.5	10	10	10	8.8	11.0	13.2
9	7.65	9.7	9.7	9.7	5.13	5.49	5.93	5.9	5.6	5.6	10.4	10.1	10.1	8.8	11.0	13.2
10	8.4	9.7	9.7	9.7	5.13	5.49	5.93	6.1	5.8	5.7	10.6	10.3	10.2	8.8	11.0	13.2
12	10.2	11.3	11.3	11.3	5.13	5.49	5.93	6.6	6.2	6	11.1	10.7	10.5	11.0	13.2	15.4
15	12.7	11.3	11.3	11.3	5.13	5.49	5.93	7.5	6.9	6.6	12	11.4	11.1	11.0	13.2	15.4
18	15.3	12.8	12.8	12.8	5.13	5.49	5.93	8.6	7.8	7.4	13.1	12.3	11.9	11.0	13.2	17.6
21	17.0	12.8	12.8	12.8	5.13	5.49	5.93	8.6	7.8	7.4	13.1	12.3	11.9	11.0	13.2	17.6
24	19.5	14.4	14.4	14.4	5.13	5.49	5.93	9.5	8.5	8	14	13	12.5	13.2	15.4	19.8
27	22.0	14.4	14.4	14.4	5.13	5.49	5.93	10.5	9.4	8.8	15	13.9	13.3	13.2	15.4	19.8
30	24.4	16	16	16	5.13	5.49	5.93	11.5	10.2	9.6	16	14.7	14.1	13.2	17.6	22.0
33	27.5	16	16	16	5.13	5.49	5.93	12.7	11.3	10.6	17.2	15.8	15.1	13.2	17.6	22.0
36	29.0	16	16	16	5.13	5.49	5.93	13.3	11.8	11.1	17.8	16.3	15.6	13.2	17.6	22.0
39	31.5	19.1	19.1	19.1	5.13	5.49	5.93	14.3	12.7	11.9	18.8	17.2	16.4	15.4	19.8	26.5
42	34.0	19.1	19.1	19.1	5.13	5.49	5.93	15.2	13.5	12.7	19.7	18	17.2	15.4	19.8	26.5
45	36.5	20.6	20.6	20.6	5.13	5.49	5.93	16.2	14.4	13.5	20.7	18.9	18	17.6	22.0	26.5
48	39.0	22.2	22.2	22.2	5.13	5.49	5.93	17.2	15.3	14.3	21.7	19.8	18.8	17.6	22.0	28.7
54	42.0	22.2	22.2	22.2	5.13	5.49	5.93	18.4	16.3	15.2	22.9	20.8	19.7	17.6	22.0	28.7
60	48.0	23.7	23.7	23.7	5.13	5.49	5.93	20.8	18.4	17.2	25.3	22.9	21.7	19.8	24.3	30.9
66	53.0	30	25.3	25.3	5.13	5.49	5.93	22.7	20.1	18.7	27.2	24.6	23.2	22.0	24.3	33.1
72	57.0	30	26.8	26.8	5.13	5.49	5.93	24.3	21.5	20	28.8	26	24.5	22.0	26.5	35.3
78	62.0	33.2	33.2	33.2	5.13	5.49	5.93	26.3	23.2	21.6	30.8	27.7	26.1	24.3	30.9	41.9
84	68.0	36.3	36.3	36.3	5.13	5.49	5.93	28.7	25.3	23.5	33.2	29.8	28	24.3	33.1	44.1
90	72.0	37.8	37.8	37.8	5.13	5.49	5.93	30.2	26.6	24.8	34.7	31.1	29.3	26.5	35.3	46.3
96	76.0	39.3	39.3	39.3	5.13	5.49	5.93	31.8	28	26.1	36.3	32.5	30.6	26.5	35.3	48.5
108	84.0	42.5	42.5	42.5	5.13	5.49	5.93	35	30.8	28.7	39.5	35.3	33.2	28.7	37.5	52.9
120	98.0	45.6	45.6	-	5.49	5.93	-	35.6	33.1	-	40.1	37.6	-	41.9	57.3	-
132	106	48.7	48.7	-	5.49	5.93	-	46.9	44.2	-	59.9	57.2	-	48.5	66.1	-
138	111	51.8	51.8	-	5.49	5.93	-	48.6	45.8	-	61.6	58.8	-	50.7	68.3	-
144	115	51.8	51.8	-	5.49	5.93	-	50	47.1	-	63	60.1	-	50.7	68.3	-
162	130	68.3	68.3	-	5.49	5.93	-	55.2	51.8	-	68.2	64.8	-	59.5	81.6	-
168	131	69.8	69.8	-	5.49	5.93	-	55.5	52.2	-	68.5	65.2	-	61.7	83.8	-
172	140	71.4	71.4	-	5.49	5.93	-	58.6	55	-	71.6	68	-	63.9	86.0	-
180	144	72.9	72.9	-	5.49	5.93	-	60	56.3	-	73	69.3	-	63.9	88.2	-
192	152	74.5	74.5	-	5.49	5.93	-	62.7	58.9	-	75.7	71.9	-	66.1	90.4	-
198	160	77.6	77.6	-	5.49	5.93	-	65.5	61.4	-	78.5	74.4	-	68.3	92.6	-
204	165	79.2	79.2	-	5.49	5.93	-	67.2	63	-	80.2	76	-	70.5	94.8	-
216	174	88.6	88.6	-	5.49	5.93	-	70.3	65.9	-	83.3	78.9	-	77.2	105.8	-
228	180	91.7	91.7	-	5.49	5.93	-	73.1	68.5	-	86.1	81.5	-	79.4	108.0	-
240	190	93.2	93.2	-	5.49	5.93	-	75.8	71	-	88.8	84	-	81.6	112.4	-

\*Phase-to-Ground clearances are expressed as minimum arrester centerline-to-ground distances. Phase-to-Phase clearances are expressed as minimum arrester centerline-to-centerline distances. Phase-to-Phase and Phase-to-Ground clearances are based upon arrester protective characteristics and should be adjusted accordingly to meet local clearance requirements for energized equipment.

# UltraSIL™ Polymer-Housed VariSTAR™ Type US, UH, and UX Station-Class Surge Arresters

## **Bracket or Structure Mounting**

When bolting arresters directly to structures, or mounting brackets, the assembly should be rigid enough to prevent mechanical failure.

## **Suspension Mounting**

Eaton offers more flexibility for customers to mount arresters in the field. Station-Class Arresters can be configured in the underhung position (suspension mount) at the plant or with a unique new option assembled in the field in the underhung position. For additional information regarding suspension mounting, contact your Eaton Cooper Power series product factory representatives.

**Note:** It is important to remember arrester sheds must be angled downwards to prevent collection of water when installed in the underhung (suspension mount) position.

## **Horizontal Mounting**

Type US, UH, and UX Station-Class Arrester can be horizontal mounted through an arrester rating of 120 kV (housing codes 60 or less).

# UltraSIL™ Polymer-Housed VariSTAR™ Type US, UH, and UX Station-Class Surge Arresters

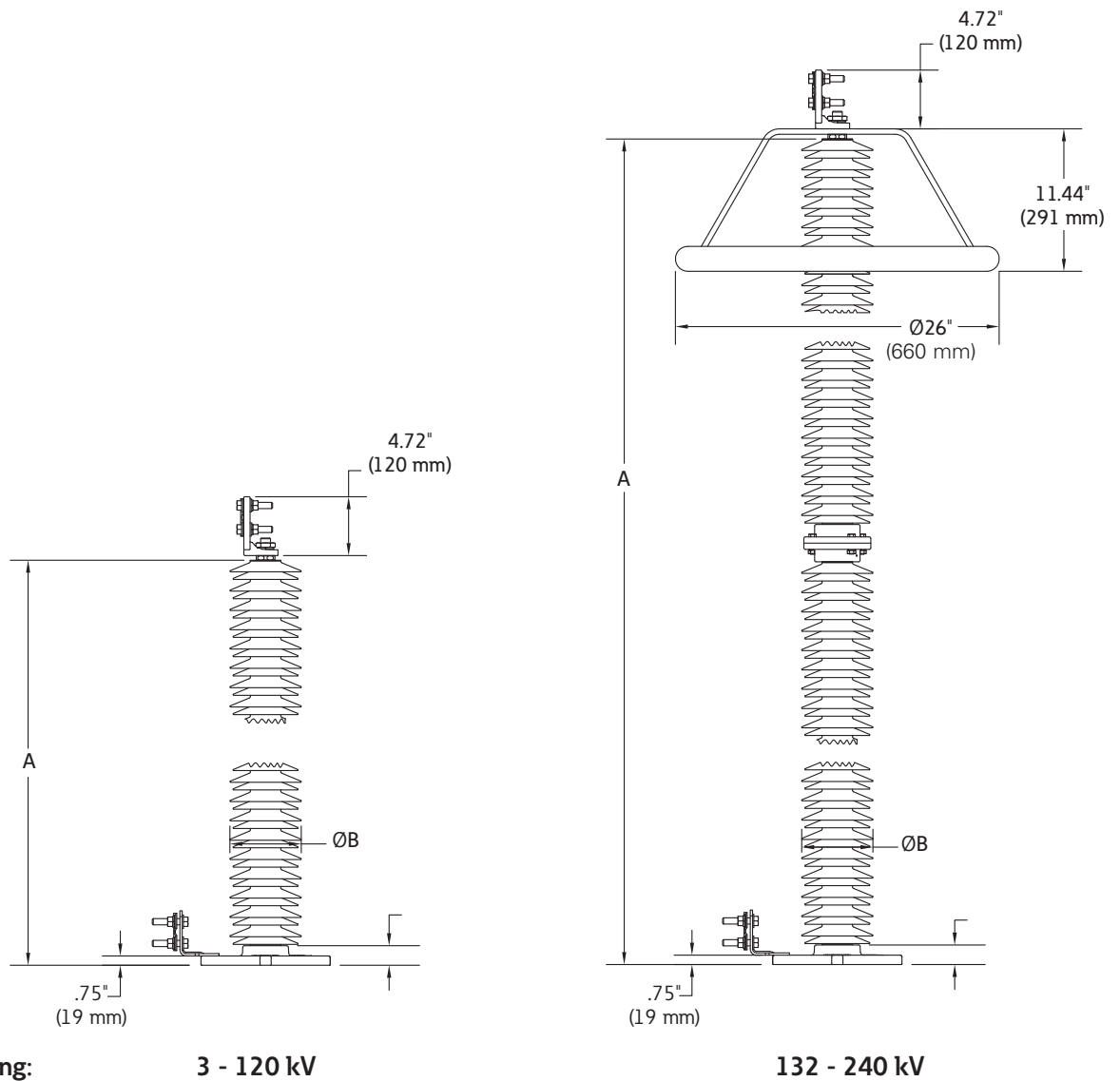

**Figure 8. Standard UltraSIL polymer-housed type US, UH, and UX arrester dimensions**

**Note:** Refer to Table 1 for dimensions "A" and "B." Arresters shown with standard line terminal, option 4 and with standard ground terminal option 5. Outlines in Figure 8 represent standard arrester catalog numbers from catalog CA235013EN. Outline dimensions will vary when optional housing codes are selected. Consult factory for more information.

## Electrical connections

Install the arrester as close as possible (electrically) to the apparatus being protected. Line and ground connections must be short and direct. Make the ground connection to a solid, effective, and permanent low-resistance ground.

**Note:** Equipment protection will be improved by interconnecting the arrester ground connections with the transformer tank and system neutral whenever possible.

---

### CAUTION

---

**To prevent strains on the arrester when suspension-mounting, suspend it freely. Always make flexible connections to line and earth terminals.**

---

### Line Terminal Connector

Refer to detailed assembly instructions on page 3 and page 4. After installation and adjustment of the line terminal to the desired position, secure until tight.

When the line conductor is to be connected, assemble the clamp with lock washers and nuts (supplied).

The standard line terminal (with appropriate side of clamp) are suitable for copper or aluminum conductors through 1.15" diameter (1000 MCM). Consult catalog for information on other line terminal options.

### Ground Terminal Connector

Connect the ground terminal connector to the common ground system with as short a conductor as possible. The ground terminal can be attached to any of the bottom base mounting bolts (not supplied). The standard ground terminal (with clamp) accommodates copper or aluminum conductor through 0.82" dia. (500 MCM). Consult catalog for information on other ground terminal options.

---

### WARNING

---

**Before working on arresters, disconnect all line leads. Consider any part of an arrester dangerous when connected to the line, including a base not solidly grounded.**

---

### Maintenance

All UltraSIL Type US, UH, or UX Arresters, when properly applied, require no special maintenance under normal operating conditions. If the arrester is installed in an area of severe contamination, keep the arrester housing clean by washing periodically. Arresters must be spray washed evenly in order to avoid overheating. Do not use high pressure water or abrasive cleaning materials. Keep all line and ground terminals secure.

---

### WARNING

---

**Arresters can be washed while energized provided standard live washing procedures are followed.**

---

### Additional information

- CA235013EN UltraSIL Polymer-Housed VariSTAR Station-Class Surge Arrester Catalog Section
- CP1122 UltraSIL Polymer-Housed VariSTAR Type US, UH, and UX Station-Class Surge Arresters Certified Test Report



**Eaton**  
1000 Eaton Boulevard  
Cleveland, OH 44122  
United States  
Eaton.com

**Eaton's Power Systems Division**  
2300 Badger Drive  
Waukesha, WI 53188  
United States  
Eaton.com/cooperpowerseries