

Terminals

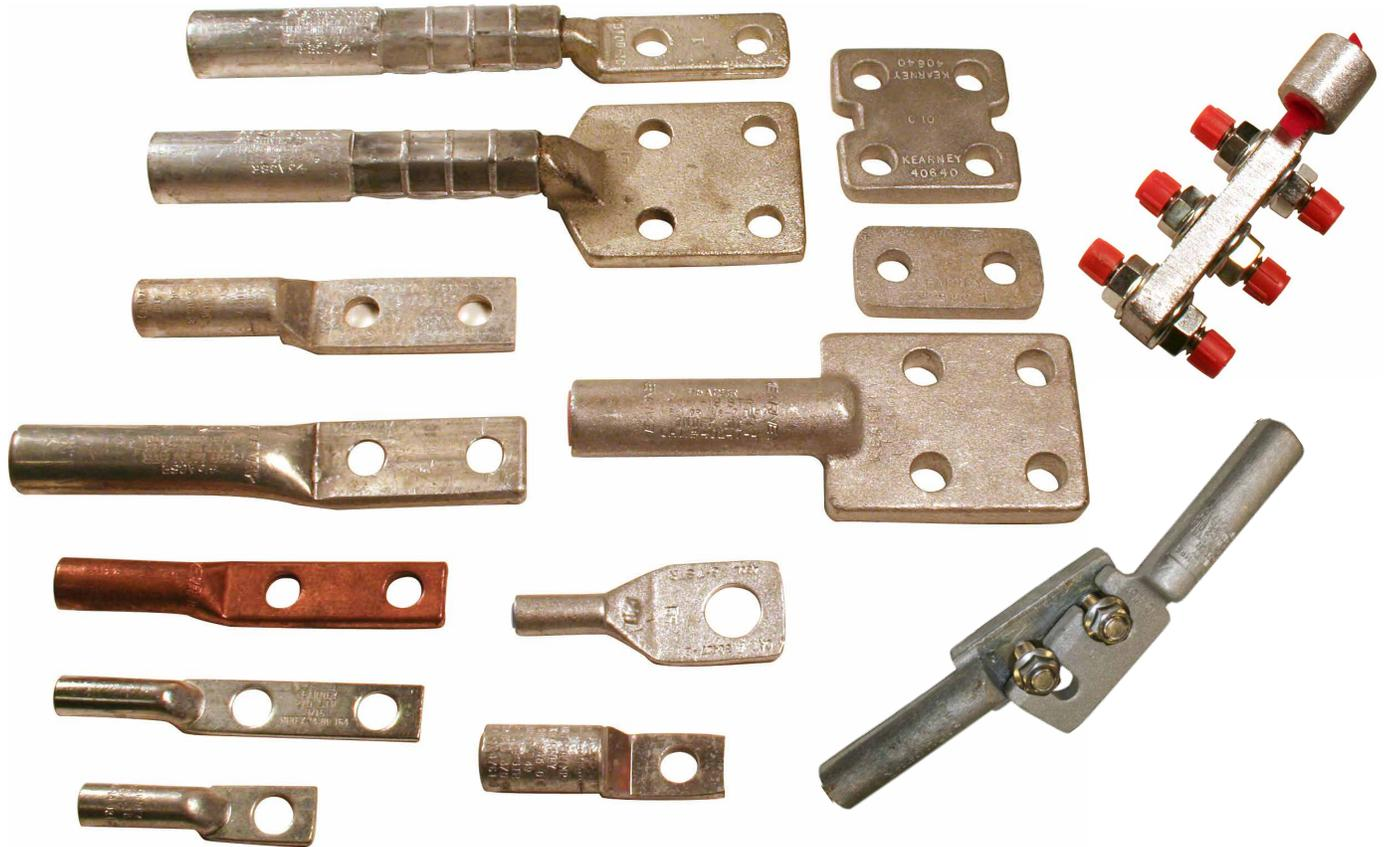

Contents

Two- and four-hole cast aluminum terminals	2	Aluminum spacers	7
Aluminum tubular terminals	4	Adapter terminals	8
Small cast aluminum terminals	4	Thinwall copper terminals	9
One-hole cast aluminum terminals	5	Copper tubular terminals	10
Grounding lugs	5	SERV-ENS adapters	10
Hot line terminals	6	Secondary terminal adapters	11
Bolt assembly	7		



Powering Business Worldwide

Effective February 2019

Two-hole and four-hole cast aluminum terminals

Eaton's Cooper Power™ series two-and four-hole cast aluminum terminals are dead soft cast aluminum fittings that are designed for terminating jumpers and taps or connecting to other types of fittings. Ends of fittings are pre-filled with Eaton's Cooper Power series Kearnalex™ inhibitor and closed with a plastic cap. The 104741 Series, with two-hole pads, can be installed with either mechanical or hydraulic tools.

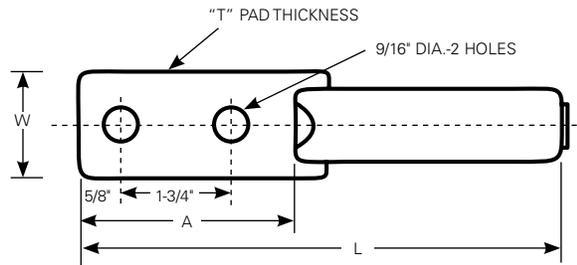

Table 1. Two-hole cast aluminum terminals

Conductor size			Dimensions (inches)				Tools & Dies	BURNDY®
Aluminum or Copper	ACSR	Catalog number	L	W	T	A	(No. of Indents)	Die Index
#1, #2	7-19 Str.	#2						
1/0	7-19 Str.	1/0						
2/0	7-19 Str.	2/0	5 3/4	1-1/4	1/4	3-1/8	O-Tool 840 (7) or 845 (5)	249
3/0	7-19 Str.	3/0					WH 840 (5)	
4/0	7-19 Str.	4/0					840-Wide (1)	
250-266	19 Str.	266.8						
300-350	19 Str.	266.8						
336	19 Str.	336.4	6	1-1/4	3/8	3-1/4	WH 1 1/8-2 (3)	317
397	19 Str.	336.4						
		397.5						655
450-477	19-37 Str.	397.5						
		477						
477-500	19-37 Str.	397.5						
		477						
500-556	19-37 Str.	556.5						
		556.5						
600-650	37 Str.	477						
		556.5						
700	37-61 Str.	636						
		605						
		556.5						
715-750	37-61 Str.	666	7	1-11/16	9/16	3-1/4	WH 1-1/2 (5)	724
		605						
		636						
		666						
750-800	37-61 Str.	636						
		715.5						
900	19-37 Str.	715.5						
		795						
954	37-61 Str.	795						
1000	37-61 Str.	795						
		874						
1033	37-61 Str.	900						
		954						

* For Aluminum or ACSR only.

Note: For tin plating add TP to the end of the part number. Example: 40133-1 without plating, 401331TP with tin plating. For 40133CPS remove "CPS" and add TP to the end of the number.



Two- and four-hole cast aluminum terminals

Two-hole and four-hole cast aluminum terminals

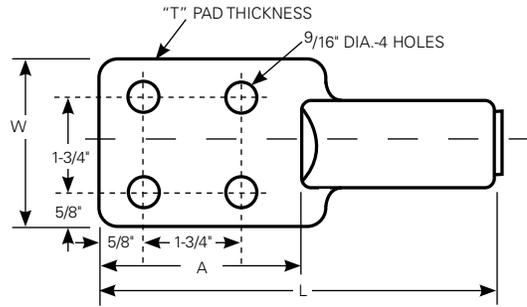

Table 2. Four-hole cast aluminum terminals

Conductor size				Catalog number	Dimensions (inches)				Tools & Dies	BURNDY®
Aluminum or Copper	ACSR				L	W	T	A	(No. of Indents)	Die Index
2/0	7-19 Str.	2/0		40247-2						
3/0	7-19 Str.	3/0		40247-3						
4/0	7-19 Str.	4/0		40247-4						
250-266	19 Str.	266.8	18/1	40247-8	7-11/16	3	9/16	3-1/4	WH 1-1/8-2 (5)	317 655
300-350	19 Str.	266.8	26/7	40247-5						
336	19 Str.	336.4	18/1	40247-7						
397	19 Str.	336.4	26/7-30/7	40247-6						
		397.5	18/1							
450-477	19-37 Str.	397.5	26/7	40603						
477-500	19-37 Str.	477	18/1	40603-1						
		397.5	30/7							
500-556	19-37 Str.	477	24/7-26/7	40603-2						
		556	18/1							
600-650	37 Str.	477	24.7	40603-3						
		556	26/7-24/7							
700	37-61 Str.	636	18-1	40603-4	7	3	9/16	3-1/4	WH 1-1/2 (5)	724
		605	26/7							
		556	30/7							
715-750	37-61 Str.	666	24/7	40603-5						
		605	30/19							
		636	26/7							
		666	54/7							
750-800	37-61 Str.	636	30/19	40603-6						
		715	54/7							
900	19-37 Str.	715.5	26/7	40603-7						
		795	45/7-36/1							
954	37-61 Str.	795	26/7	40603-9	8-11/16	3	9/16	3-1/4	WH 1-1/2 (8)	724
1000	37-61 Str.	795	30/19							
		874	54/7							
1033	37-61 Str.	900	54/7	40603-11*						

* For Aluminum or ACSR only.

Note: For tin plating, add TP to the end of the number. Example: 40603-5 without plating, 40603-5TP with tin plating, for 40603, add TP to the end of the number.

Aluminum tubular terminals

Aluminum tubular terminals offer an aluminum compression terminal of seamless aluminum tubing with a two-hole pad used for terminating aluminum and ACSR conductors. The end is factory filled with Kernalex inhibitor and capped.

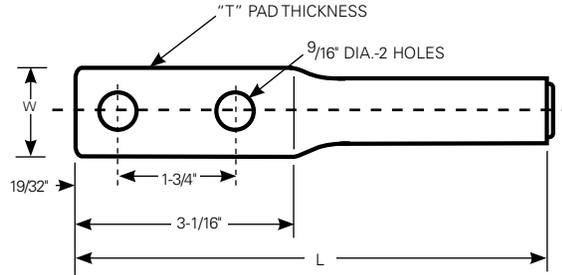

Table 3. Aluminum tubular terminals

Conductor size			Catalog number	Dimensions (inches)			Tools & Dies (No. of Indents)	BURNDY® Die Index
Aluminum or Copper	ACSR			L	W	T		
2/0	7-19 Str.	1/0	36233CPS	7-1/8	1	5/16	O-Tool 737 (10) WH 737 (7)	677
3/0	7-19 Str.	2/0	36234	7-1/8	1-1/8	3/8	O-Tool 840 (12) WH 840 (8)	249
4/0	7-19 Str.	3/0	48212	7-1/8	1-3/16	5/16		
-	-	4/0	48160	7-1/8	1-3/16	1/4		
4/0	7-19 Str.	3/0	36235	7-1/8	1-3/8	15/32	WH 1-2 (4)	UK1T
250	19-37 Str.	4/0	36236CPS	7-1/8	1-3/8	13/32		
300	19-37 Str.	266.8	36237CPS	8	18/1-26/7	1-9/16	WH 1-1/8-2 (5)	317
336-350	19-37 Str.	336.4			18/1	1-9/16		
400	19-37 Str.	336.4	36239CPS	9-1/8	26/7-30/7	1-5/8	WH 1-1/8-2 (6)	317
		397.5			18/1	1-5/8		
477	19-37 Str.	477	36950CPS		18/1	1-11/16	9/32	
500	37-61 Str.					1-11/16		



Aluminum tubular terminal

Small cast aluminum terminals

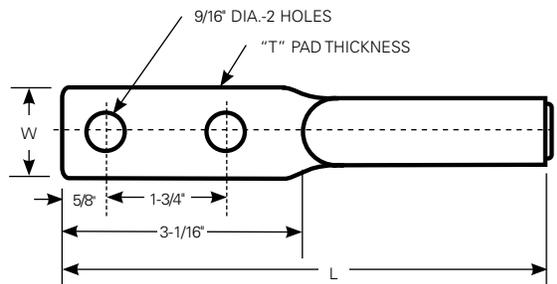

Table 4. Small cast aluminum terminals

Conductor size			Catalog number	Dimensions (inches)			Tools & Dies (No. of Indents)	BURNDY® Die Index
Aluminum or Copper	ACSR			L	W	T		
#6 Str. or #4 Sol.	-		48398	5-3/16	1	5/16	O-Tool 5/8" Nose (10)	BG
#4-7 Str.	#4		40155CPS	5-3/16	1	5/16		
#1 & #2 Str.	#2		36918	5-3/16	1	5/16		
1/0	7-19 Str.	1/0	104734	5-1/4	1-1/4	5/16	O-Tool 737 (6) or 747 (4) WH 737 (4) or 747 (3)	677 247



Small cast aluminum terminal

One-hole cast aluminum terminals

One-hole cast aluminum terminals offer compact terminal design for use on insulated cable; covers all popular stranded, solid, and compact sizes. Terminal size is suited for use on meter sockets, low cost termination on pad-mounted transformers, and in industrial buswork.

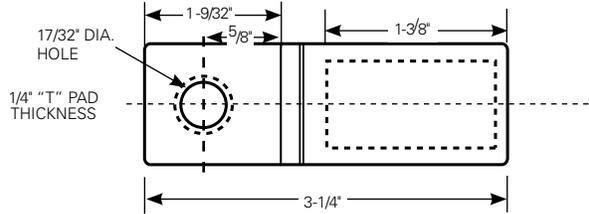

Table 5. One-hole cast terminals

Conductor size		Catalog number	Tools & Dies (No. of Indents)
Aluminum only			
#4 Str. / Comp. / Solid		104761-1	
#2 Str. / Comp. / Solid		104761-2	
1/0 Str. / Comp / Solid and 2/0 Solid		104761-3	O-Tool 840(6) or 845(4)
2/0 Str. / Comp. / Solid and 3/0 Solid		104761-4	WH Tool 840(4) or 29/32(2) or 840-WIDE(1)
3/0 Str./ Comp. 4/0 Solid		104761-5	
4/0 Str./ Comp. 250 Comp.		104761-6	
250 Str. / 300 Comp.		104761-7	BURNDY®: MD6 Tool 249(4) Y35 Tool 249(2)
300 Str. / 350 Comp.		104761-8	
336 Str. / 350 Comp.		104761-9	



One-hole cast terminal

Grounding lugs

Grounding lugs offer one-hole lugs for grounding line hardware or switchgear to transmission structure.

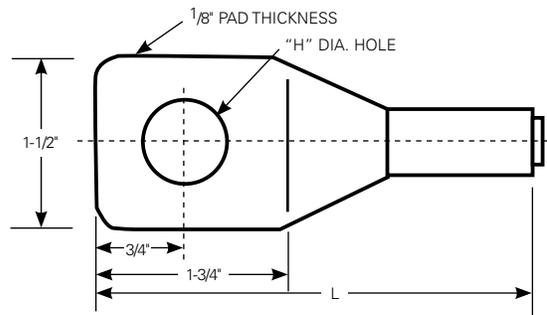

Table 6. Grounding Lugs

Conductor size			Dimensions (inches)		Tools & Dies (No. of Indents)
Aluminum or Copper	ACSR	Catalog number	H	L	
#6 Str. to #4 Sol.	#6	30426-2	11/16		
#4 Str. to #2 Sol.	#4	30427CPS	13/16		
#6 Str. to #4 Sol.	#6	30427-2	13/16	3-25/32	O-Tool 5/8 Nose (4) WH BKT (1)
#6 Str. to #4 Sol.	#6	30427-9	15/16		
#4 Str. to #2 Sol.	#4	30427-10			



Grounding lugs

Hot line terminals

Hot line terminals-slotted

Slotted hot line terminals offer compression end terminals with slotted pads that engage captive bolts.

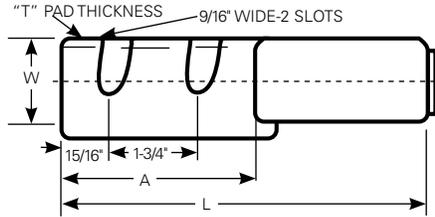

Table 7. Hot line terminals-slotted

Conductor size			Dimensions (inches)				Tools & Dies (No. of Indents)	BURNDY® Die Index
Aluminum or Copper	ACSR	Catalog number	L	W	T	A		
1/0 Str.	1/0	104719	8	2	1/2	3-5/8	1-1/8-2 (5)	317 426
2/0 Str.	2/0	104709						
3/0 Str.	3/0	104725						
4/0 Str.	4/0	104710						
250-266 Str.	266.1 18/1	104771						
336 Str.	336.4 18/1	104711						
397 Str.	336.4 26/7	104717						
450-477 Str.	397.5 26/7	104722-01						
500-556 Str.	397.5 30/7	104722-02	7-5/16	2	3/4	3-5/8	1-1/2 (5)	608
	477 18/1							
-	477 24/7							
	556.5 18/1	104722-03						
795 Str.	795 36/1	104722-07						



Hot line terminals-slotted

Hot line terminals-captive bolts

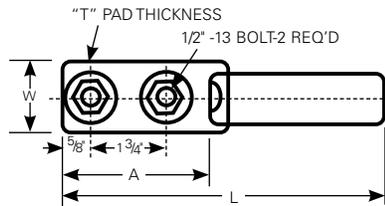

Hot line terminals-captive bolts

Table 8. Hot line terminals - captive bolts

Conductor size			Dimensions (inches)				Tools & Dies (No. of Indents)	BURNDY® Die Index
Aluminum or Copper	ACSR	Catalog number	L	W	T	A		
2/0 Str.	2/0	104703	7-11/16	1-11/16	9/16	3-11/16	WH 1-1/8-2 (5)	317 426
3/0 Str.	3/0	104726						
4/0 Str.	4/0	104704						
336 Str.	336.4 18/1	104705	7-11/16	1-11/16	9/16	3-1/4		
397-400 Str.	336.4 26/7-30/7	104781*	9-1/8	1-5/8	7/16	3-1/16	WH 1-1/8-2 (6)	317 426
	397.5 18/1							
-	397.5 30/7	104723-2	7	1-11/16	9/16	3-1/4	WH 1-1/2 (5)	608
	477 18/1							
500-556.5 Str.	477 24/7	104723-3	7	1-11/16	9/16	3-1/4	WH 1-1/2 (5)	608
	556.5 18/1							
795 Str.	795 36/1	104723-7						

* This item is a tubular terminal with loose hardware.

Bolt assembly

Bolt assembly parts are stainless steel. The length of bolts required is determined by adding the pad thicknesses of all terminals, plus spacers, if used. Each catalog number covers one hex head bolt, one hex nut, one lockwasher and two flat washers.

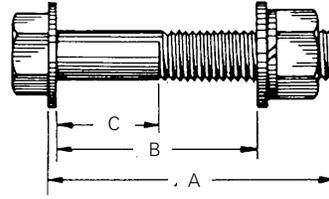

Table 9. Bolt assembly

Catalog number	Bolt size (inches) A	Pad stack Accommodated (inches)	
		Max. B	Min. C
40717-6S	1/2-13 x 1-1/4	9/16	—
40717-S	1/2-13 x 1-1/2	3/4	3/16
407171S	1/2-13 x 2	1-1/4	11/16
40717-7S	1/2-13 x 2-1/4	1-9/16	15/16
40717-2S	1/2-13 x 2-1/2	1-3/4	1-3/16
40717-3S	1/2-13 x 3	2-1/4	1-11/16
40717-5S	1/2-13 x 3-1/2	2-1/2	2-3/16
40717Z4S	1/2-13 x 4	3-1/4	2-11/16



Bolt assembly

Aluminum spacers

Aluminum spacers fill the need to provide separation between the barrels of adjacent terminals.

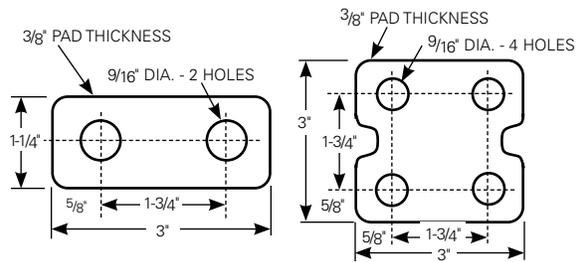

Table 10. Aluminum spacers

Type	Catalog number
Two-Hole	40640-1
Four-Hole	40640



Aluminum spacers

Effective February 2019

Adapter terminals

Adapter terminals offer a Kearnalex inhibitor-filled aluminum sleeve, factory compressed on a plated bronze terminal pad. Adapter terminals are used in connection of aluminum conductors to equipment with bronze or copper pads to avoid the potential for galvanic corrosion.

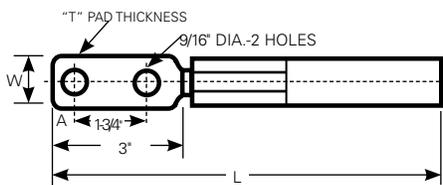

Table 11. Two-hole adapter terminals

Conductor size			Dimensions (inches)				Tools & Dies (No. of Indents)	BURNDY® Die index
Aluminum	ACSR	Catalog number	L	W	T	A		
1/0 7-19 Str.	1/0	48713	9-3/8	1-1/4	5/16	1/2	WH 1-1/8-2 (4)	317 655
2/0 7-19 Str.	2/0	48713-1						
3/0 7-19 Str.	3/0	48713-2						
4/0 7-19 Str.	4/0	48713-3						
250-266	—	48713-4	10-3/8	1-1/4	5/16	1/2	WH 1-1/8-2 (5)	
336.4	266.8 18/1-26/7	48713-5	11	1-1/2	3/8	5/8		
297-350	336.4 18/1-26/7	48713-6	11	1-1/2	3/8	5/8	WH 1-5/16 (7)	UK1516T
400	336.4 30/7 397.5 18/1	48713-7						
477-500	397.5 26/7-30/7 477 18/1	48713-8						
550-600	477 24/7-30/7 556.5 18/1	48713-9	12	1-1/2	3/8	5/8	WH 1-5/16 (9)	UK1516T
795 Str.	—	48713-12	11	1-1/2	3/8	5/8	PH25 1-1/2 (3)	608
636 Str/795 Comp	556.5 24/7-26/7	48713-16	12	1-1/2	3/8	5/8	PH25 1-1/2 (4)	



Adapter terminals

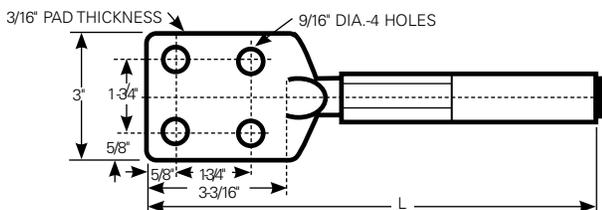

Table 12. Four-hole adapter terminals

Conductor size			Dimensions (inches)		Tools & Dies (No. of Indents)	BURNDY® Die Index
Aluminum or Copper	ACSR	Catalog number	L			
3/0 Str.	3/0	48714-2	9-3/8		WH 1-1/8-2 (4)	317, 655
4/0 Str.	4/0	48714-3				
250-266	—	48714-4	10-3/8		WH 1-1/8-2 (5)	
336.4	266.8 18/1-26/7	48714-5	11			
350-397	336.4 18/1-26/7	48714-6	11		WH 1-5/16 (7)	UK1516T
400	336.4 30/7 397.5 18/1	48714-7				
477-500	397.5 26/7-30/7 477 18/1	48714-8				
550-600	477 24/7-30/7 556.5 18/1	48714-9	12		WH 1-5/16 (9)	UK1516T
795 Compact	—	48714-11	11		WH 1-1/2 (4)	608
636 Str/795 Comp	556.5 26/7	48714-10	11		WH 1-1/2 (3)	

Thinwall copper terminals

Thinwall copper terminals are designed for general use on copper cables. Especially recommended for underground distribution system. They are made of seamless copper tubing, annealed for easy compression and tin-plated for resistance to corrosion.

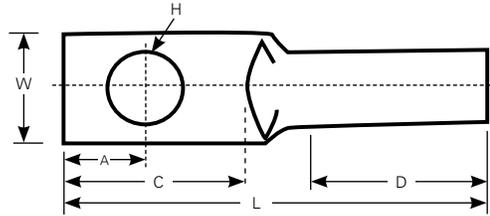

Table 13. One-hole thin-wall copper terminals

Conductor size Copper	Catalog number	Dimensions - (inches)							Tools & Dies (No. of Indents)			BURNDY® Die Index
		A	B	C	D	H	L	W	Die	O-Tool	WH	
#4 Str.	136711-004	3/8	—	3/4	1-1/8	25/64	2-5/32	19/32	5/16	(5)	(2)	W161
#2 Str.	136711-002	9/16	—	1-1/8	1-1/4	25/64	2-11/16	19/32	3/8	(5)	(2)	10 WK38
1/0 Str.	136711-010	9/16	—	1-1/8	1-1/2	25/64	3-1/16	3/4	1/2	(5)	(2)	12 WK12
2/0 Str.	136711-020	9/16	—	1-1/8	1-1/2	9/16	3-1/8	13/16	9/16	(5)	(3)	W164
3/0 Str.	136711-030	9/16	—	1-1/8	1-1/2	9/16	3-1/8	15/16	9/16	(5)	(3)	W164
4/0 Str.	136711-040	9/16	—	1-1/8	1-5/8	9/16	3-11/32	1-1/32	5/8-1	(5)	(3)	W165

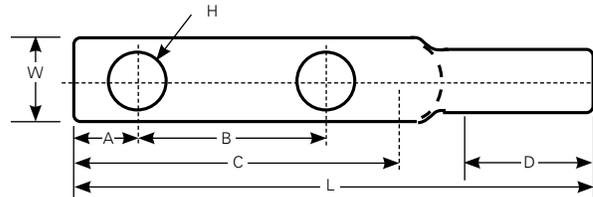

Table 14. Two-hole thin-wall copper terminals

Conductor size Copper	Catalog number	Dimensions - (inches)							Tools & Dies (No. of Indents)			BURNDY® Die Index
		A	B	C	D	H	L	W	Die	O-Tool	WH	
1/0 Str.	136712-010	11/32	7/8	1-5/8	1-1/4	25/64	3-7/16	3/4	1/2	(5)	(2)	12 WK12
2/0 Str.	136712-020	5/8	1-3/4	3-1/8	1-3/8	9/16	5-1/32	27/32	9/16	(5)	(3)	13 W164
3/0 Str.	136712-030	5/8	1-3/4	3-1/8	1-3/8	9/16	5-3/32	29/32	9/16	(5)	(3)	14
4/0 Str.	136712-040	5/8	1-3/4	3-1/8	1-1/2	9/16	5-9/32	1-1/32	5/8-1	(5)	(3)	U165
250kcmil	136712-250	5/8	1-3/4	3-1/8	1-1/2	9/16	5-5/16	1-1/8	11/16	(5)	(3)	U676
300kcmil	136712-300	5/8	1-3/4	3-1/8	1-15/16	9/16	5-3/4	1-9/32	781	(5)	(3)	17 WK781
350kcmil	136712-350	5/8	1-3/4	3-1/8	2-1/8	9/16	5-25/32	1-15/16	840	(5)	(3)	U168
500kcmil	136712-500	5/8	1-3/4	3-1/8	2-1/4	9/16	6-3/16	1-17/32	1-2	—	(4)	20 U654
750kcmil	136712-750	5/8	1-3/4	3-1/8	2-3/4	9/16	7	1-29/32	1-5/16 b	—	(3) ^b	Y44PR E39D

b Must be installed with a 15-ton or larger tool.



Thinwall copper terminals

Copper tubular terminals

Copper tubular terminals are used to connect copper conductors to bronze or copper switch pads. These terminals are offered with pure copper seamless tubing with one end flattened to form a pad with holes on NEMA® centers.

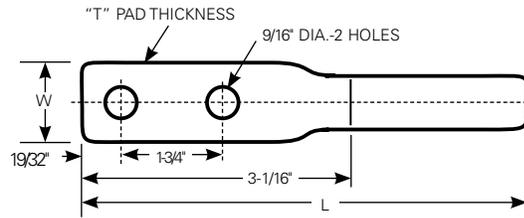

Table 15. Copper tubular terminals

Conductor size Copper	Catalog number	Dimensions (inches)			Tools and Dies	BURNDY®
		L	W	T	(No. of Indents)	Die Index
2/0 7-19 Str.	40869	5-1/2	1	0.288	WH 11/16 (4)	676
4/0 7-19 Str.	40871	5-5/8	1-1/8	0.285	WH 840 (5)	168



Copper tubular terminals

SERV-ENS adapters

Eaton's Cooper Power series SERV-ENS™ adapters or pin terminals provide a means of terminating aluminum or ACSR conductors into bronze or copper terminals of equipment such as transformers, cutouts, arresters, capacitors, and meter boxes. The compression barrel is factory filled with Kernalex inhibitor.



SERV-ENS adapter

Table 16. Pin terminals

Conductor size		Catalog number	Copper Stud		Cap	Tools & Dies (No. of Indents)	BURNDY® Die Index
Aluminum	ACSR		Size	Length (in.)	Color		
#6 Str. #4 Sol	#6	103908-1	4 Sol.	5-5/8	Blue	O-Tool 5/8 Nose (3) or 620 (3)	BG
#3, 4 Str. #2 Sol	#4	103909	4 Sol.	2	Orange		
#3, 4 Str. #2 Sol	#4	103909-1	4 Sol.	5-5/8	Orange		
#1, 2 Str.	#2	103910	4 Sol.	2	Red		
#1, 2 Str.	#2	103910-1	4 Sol.	5-5/8	Red		
1/0 Str.	1/0	103911	2 Sol.	2	Yellow		
1/0 Str.	1/0	103911-1	2 Sol.	5-5/8	Yellow	O-Tool 840 (7) WH 840 (4)	249
1/0 Str.	1/0	40668	2 Sol.	5-1/4	Yellow		
2/0 Str.	2/0	103945	3/8" dia.	4	Gray		
3/0 Str.	3/0	40628	1/0 Sol.	6-1/4	Black		
3/0 Str.	3/0	40019CPS	1/0 Sol.	2-3/4	Black		
4/0 Str.	4/0	40549	1/0 Sol.	4-5/8	Pink		
4/0 Str.	4/0	26485-12	1/0 Sol.	2-3/4	Pink		
4/0 Str.	4/0	103943	3/8" dia.	10	Pink		
4/0 Str.	4/0	103944	3/8" dia.	4	Pink		
336 kcmil	266.8	36691-1		3-3/4			
350-397 kcmil	336.4	49603-1	1/2" dia.	4			
350-397 kcmil	336.4	49603		6-1/4			
400-500 kcmil	—	40363-1		6-1/4			
750 kcmil	—	103929	3/4" dia.	6		WH 1-1/2 (8)	608

Secondary terminal adapters for pad-mounted transformers with threaded studs

Secondary terminal adapters are an economical and convenient means of connecting secondaries and services to threaded stud-type pad-mounted transformers.

Adapters are made of pure cast aluminum with permanently affixed 1/2" stainless steel studs for attaching the secondary terminals. Flange nuts lock the terminals tightly in place. The captive studs eliminate the necessity of handling loose bolts.

The threaded mounting hole for attaching the adapter to the transformer stud is factory filled with Kearnaalex inhibitor and capped. The jam nuts on the transformer stud securely lock the adapter into position.

The adapter has six studs (three on each side) for attaching one-hole aluminum terminals.

Plastisol insulating boots are available to provide economical "dead-front" insulation.

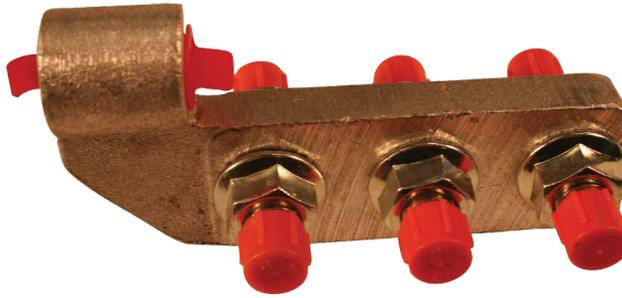

Terminal adapter

Table 17. Secondary terminal adapter

Catalog number	Description
104793	Terminal Adapter: 6 One-hole taps. Mates with 5/8"-11UNC-2B threaded stud
107663	Insulating Boot for Terminal Adapter
107702	Adapter/Boot Kit: Contains (3) adapters and (3) Boots

Adapter and insulating boot kit

Adapter and insulating boot kits consist of three adapters and three insulating boots and can be ordered by specifying the following catalog number: 107702.



Insulating boot

Eaton
1000 Eaton Boulevard
Cleveland, OH 44122
United States
Eaton.com

Eaton's Power Systems Division
2300 Badger Drive
Waukesha, WI 53188
United States
Eaton.com/cooperpowerseries

© 2019 Eaton
All Rights Reserved
Printed in USA
Publication No. CA325008EN
February 2019

Eaton is a registered trademark.
All other trademarks are property
of their respective owners.

For Eaton's Cooper Power series product
information call 1-877-277-4636 or visit:
www.eaton.com/cooperpowerseries.