

# NX<sup>®</sup> indoor current-limiting fuses



## General

Eaton provides overload protection for all indoor and underground cable distribution systems 2.4 through 34.5 kV with its Cooper Power™ series NX<sup>®</sup> current-limiting fuses. NX fuses are noiseless and expel no hot gases or burning particles while interrupting currents from minimum melt to maximum fuse rating (50,000 A through 23 kV, 35,000 A through 27 and 38 kV). Their current-limiting capability greatly reduces the momentary duty on protected equipment, extending the life and, in some cases, reducing the original cost of that equipment.

The ability of an NX fuse to interrupt low-current faults eliminates the need for auxiliary devices to handle these troublesome current levels. An NX fuse extends system coordination because it is fast clearing and current-limiting—conductor and equipment damage caused by high currents is virtually eliminated.

## Clip-style NX fuse

The basic NX fuse unit (top left) is designed to mount in a clip-style mounting. Basic clip-style NX fuses are available in 4.3, 5.5, 8.3, 15.5, 23, 27, and 38 kV ratings.

## NX Fuse with Arc-Strangler loadbreak device

An NX fuse with an Eaton's Cooper Power series Arc-Strangler<sup>®</sup> loadbreaking device, (top middle) that mounts in a hinge-style mounting is available on 4.3, 5.5, 8.3, and 15.5 kV fuses. All current magnitudes from excitation current through 200 A can be interrupted positively and safely by opening the fuse with a switch disconnect stick.

These units have the same operating characteristics as the basic clip-style fuse, along with loadbreaking capabilities.

## Arc-Strangler switchblade

Switchblades with the Arc-Strangler loadbreaking device are available in 8.3 and 15.5 kV, 200 A continuous current ratings (top right).

**EATON**

Powering Business Worldwide

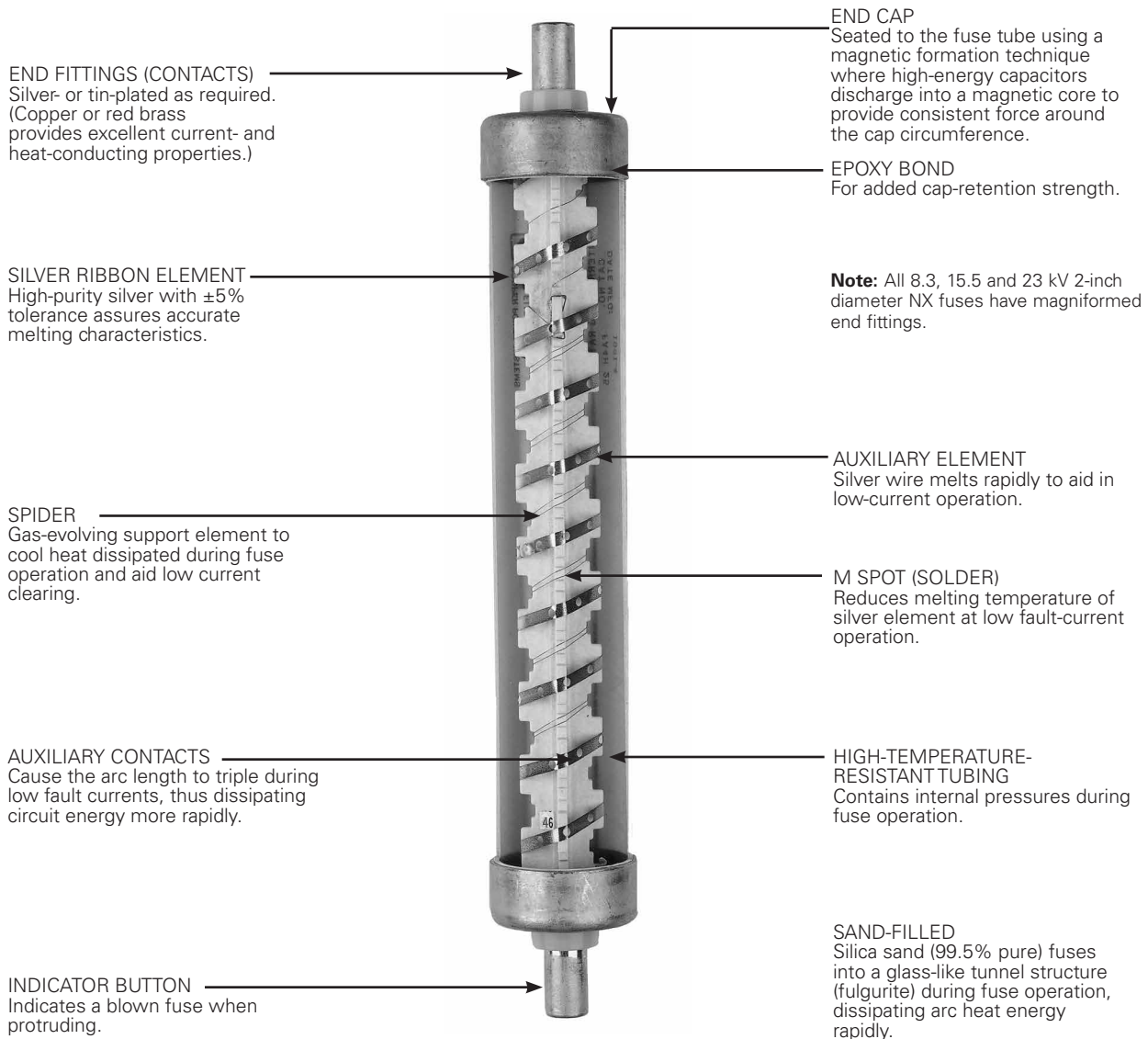

Figure 1. Basic components of the NX current-limiting fuse.

Table 1. Electrical Characteristics

Fuse Type	Full Range
Maximum Interrupting Current (symmetrical)	4.3 kV through 23 kV 50,000 A 27 kV and 38 kV 35,000 A

Table 2. NX Fuse Time Current Characteristic (TCC) Curves

Voltage Rating (kV)	TCC Curve
4.3	R240-91-30
5.5	R240-91-31
8.3	R240-91-32
15.5	R240-91-33
23	R240-91-34
27.38	R240-91-35

## Installation

The NX clip- and hinge-style fuses are designed to fit industry standard mountings. Each fuse is marked with its mounting code number. The mounting code number defines the mounting's insulation level, contact spacing and contact type. NX clip-style fuses fit 5/8" standard clip-style mountings in pad-mounted transformers, switchgear, sectionalizing enclosures, industrial vaults, and metal clad switchgear. The NX hinge-style fuses fit the standard hinge-style mountings. The mounting code number of the fuse and the mount must be the same. Refer to catalog section 240-59, for more detailed information on clip- and hinge-style mountings.

**Table 3. Electrical Ratings**

Contin- uous Current Rating (A)	Maximum Design Voltage													
	4.3 kV		5.5 kV		8.3 kV		15.5 kV		23 kV		27 kV		38 kV	
	Min. Melt I <sup>2</sup> t (A <sup>2</sup> S)x10 <sup>3</sup>	Max. Let through I <sup>2</sup> t (A <sup>2</sup> S)x10 <sup>3</sup>	Min. Melt I <sup>2</sup> t (A <sup>2</sup> S)x10 <sup>3</sup>	Max. Let through I <sup>2</sup> t (A <sup>2</sup> S)x10 <sup>3</sup>	Min. Melt I <sup>2</sup> t (A <sup>2</sup> S)x10 <sup>3</sup>	Max. Let through I <sup>2</sup> t (A <sup>2</sup> S)x10 <sup>3</sup>	Min. Melt I <sup>2</sup> t (A <sup>2</sup> S)x10 <sup>3</sup>	Max. Let through I <sup>2</sup> t (A <sup>2</sup> S)x10 <sup>3</sup>	Min. Melt I <sup>2</sup> t (A <sup>2</sup> S)x10 <sup>3</sup>	Max. Let through I <sup>2</sup> t (A <sup>2</sup> S)x10 <sup>3</sup>	Min. Melt I <sup>2</sup> t (A <sup>2</sup> S)x10 <sup>3</sup>	Max. Let through I <sup>2</sup> t (A <sup>2</sup> S)x10 <sup>3</sup>	Min. Melt I <sup>2</sup> t (A <sup>2</sup> S)x10 <sup>3</sup>	Max. Let through I <sup>2</sup> t (A <sup>2</sup> S)x10 <sup>3</sup>
1.5	–	–	–	–	0.01	0.15	0.01	0.15	–	–	–	–	–	–
2.9	–	–	–	–	–	–	–	–	–	–	–	–	–	–
3	–	–	–	–	0.05	0.30	0.05	0.59	–	–	–	–	–	–
4.5	–	–	–	–	0.05	0.30	0.05	0.59	–	–	–	–	–	–
6	–	–	0.13	0.60	0.13	0.76	0.13	1.44	0.13	1.8	0.08	1.6	0.08	3.5
8	–	–	0.35	1.05	0.34	1.5	0.21	2.90	0.21	3.5	0.21	2.5	0.21	4.7
10	–	–	0.52	2.0	0.52	3.6	0.52	6.65	0.52	7.8	0.53	3.8	0.53	5.6
12	–	–	1.15	4.0	1.15	6.3	1.15	10.4	1.15	13.5	0.72	6.0	0.73	9.0
15	–	–	–	–	–	–	–	–	–	–	0.74	6.0	0.74	10.5
18	1.5	7.9	1.25	10.0	1.25	11.0	1.25	10.5	1.25	16.2	1.30	7.0	1.15	10.5
20	–	–	1.65	14.0	1.65	13.0	1.65	16.5	1.65	18.0	1.65	9.4	1.65	13.8
25	2.9	12.5	3.0	38.0	2.0	24.0	2.0	27.0	2.0	28.0	2.95	16.0	3.00	19.5
30	–	–	3.0	46.0	4.0	31.0	4.0	34.0	4.0	36.0	4.60	26.0	4.60	29.0
35	2.9	25.0	–	–	–	–	–	–	–	–	–	–	–	–
40	–	–	5.3	67.0	8.0	50.0	8.0	57.0	8.0	62.0	5.25	29.5	5.13	35.00
45	6.6	69.0	–	–	–	–	–	–	–	–	–	–	–	–
50	9.0	75.0	9.0	98.0	11.6	72.0	11.6	90.0	–	–	11.30	65.0	11.60	80.00
60*	–	–	–	–	15.8	125.0	16.0	132.0	–	–	18.40	104.0	18.50	117.0
65	18.2	100.0	18.2	167.0	26.5	130.0	26.5	200.0	–	–	–	–	–	–
75	26.5	150.0	26.5	244.0	–	–	–	–	–	–	–	–	–	–
80	–	–	–	–	47.0	220.0	46.5	340.0	–	–	–	–	–	–
80*	–	–	–	–	32.5	200.0	32.5	225.0	–	–	20.10	118.0	21.20	140.0
100	45.5	240.0	–	–	100.0	450.0	100.0	580.0	–	–	–	–	–	–
100*	–	–	36.0	380.0	–	–	47.0	370.0	–	–	26.00	260.0	47.00	320.0
125	–	–	–	–	–	–	–	–	–	–	–	–	–	–
125*	–	–	–	–	–	–	–	–	–	–	–	–	–	–
130*	73.0	400.0	73.0	790.0	102.0	520.0	102.0	790.0	–	–	–	–	–	–
140	–	–	–	–	–	–	–	–	–	–	–	–	–	–
150*	106.0	620.0	105.0	980.0	–	–	–	–	–	–	–	–	–	–
160*	–	–	–	–	187.0	800.0	187.0	1380.0	–	–	–	–	–	–
200*	185.0	960.0	–	–	400.0	1800.0	400.0	2350.0	–	–	–	–	–	–

\* Indicates two smaller fuses in parallel.

**Table 4. NX Clip-Style Fuse Dimensional Information (See Figure 5 for Dimensional Drawing)**

Fuse Description	Mounting Code Number*	Dimensions – inches (mm)		
		A	B	C
1-1/8" diameter fuse for clip mounting	4	10.0 (254)	1.13 (28.6)	1.00 (25)
	4	10.0 (254)	2.00 (51)	1.00 (25)
2" diameter fuse for clip mounting	5	14.31 (363)	2.00 (51)	1.00 (25)
	6	17.13 (435)	2.00 (51)	1.00 (25)
3-7/16" diameter fuse for clip mounting	5	14.69 (373)	3.44 (87)	1.19 (30)
	6	17.5 (445)	3.44 (87)	1.19 (30)
	9	27.38 (695)	3.44 (87)	1.19 (30)
	10	35.38 (899)	3.44 (87)	1.19 (30)

\* Code number of mounting must match code number of fuse.

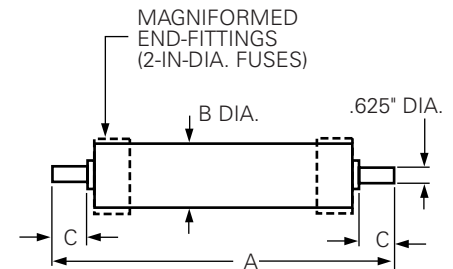

**Figure 2. NX clip style dimensional drawing. (See Table 4 for dimensions.)**

**Table 5. NX Hinge-Style Switchblade Electrical Ratings and Dimensional Information (See Figure 6 for Dimensional Drawing)**

**Electrical Ratings**

Voltage (kV)	Continuous and Loadbreak Current (A)	Description	Mounting Code Number*	Dimension A in. (mm)
8.3	200	Blade	1	14 (356)
15.5	200	Short 15 kV blade	1	14 (356)
15.5	200	Long 15 kV blade	2	18.5 (470)

\* Code number of mounting must match code number of switchblade.

**Table 6. NX Hinge-Style Fuse Dimensional Information (See Figures 4 and 5 for Dimensional Drawing)**

Fuse Description	Voltage Rating (kV)	Mounting Code Number*	Dimensions - inches (mm)				
			A	B	C	D	R
1 1/8" diameter hinged fuse**	4.3, 5.5, and 8.3	1	14.0 (356)	8.88 (226)	1.38 (35)	0.38 (10)	13.31 (338)
	15.5	2	18.5 (470)	8.88 (226)	1.38 (35)	0.38 (10)	17.81 (452)
2" diameter hinged fuse***	4.3, 5.5, and 8.3	1	13.75 (349)	8.94 (227)	2.44 (62)	1.44 (37)	13.31 (338)
	15.5	2	18.25 (463)	8.94 (227)	2.44 (62)	1.44 (37)	17.81 (452)

\* Code number of mounting must match code number of fuse.

\*\* See Figure 8 for dimensional drawing.

\*\*\* See Figure 9 for dimensional drawing.

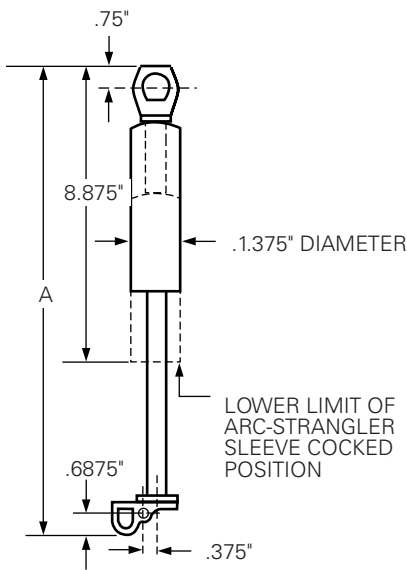

**Figure 3. NX hinge-style switchblade with Arc-Strangler loadbreaking device. (See Table 5 for dimensions.)**

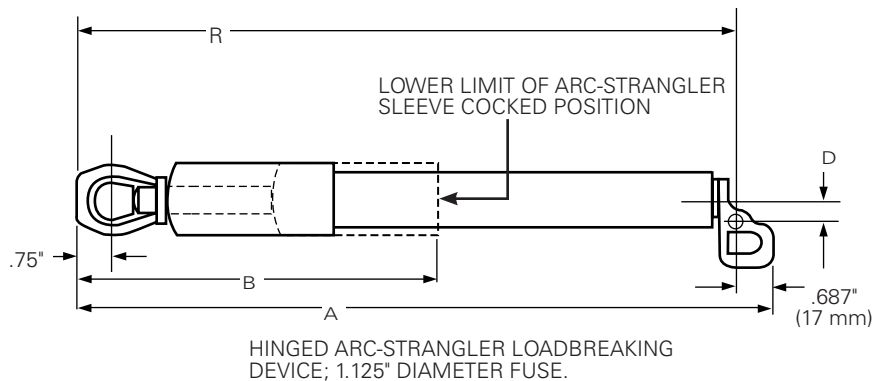

**Figure 4. NX hinge-style (1.125" dia.) fuse dimensional drawing.**

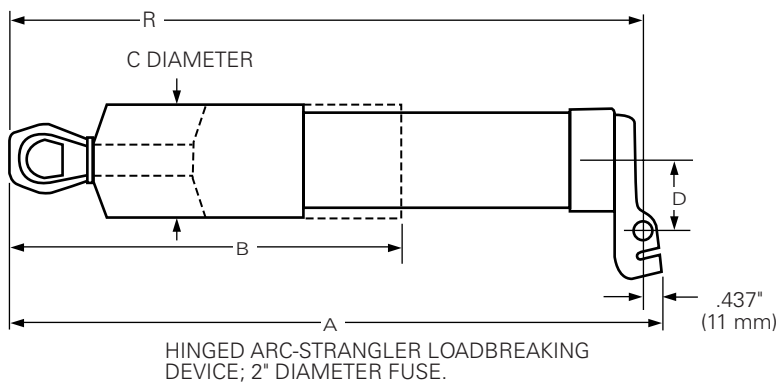

**Figure 5. NX hinge-style (2" dia.) fuse dimensional drawing.**

**Protective characteristics**

**Let-through currents**

NX fuses have the ability to limit system fault currents, frequently to a fraction of system fault capability. This greatly reduced value is referred to as let-through current.

The operating advantages, along with fast clearing, include greatly reduced burning at the point of fault and minimal line damage. In addition, there is less chance of damage, both electrical and mechanical (by magnetic forces), to other equipment in the faulted circuit. Figures 6, 7, and 8 show maximum let-through current values.

The maximum let-through curves provide an indication of the amount of current-limiting action provided by NX fuses: Assume an 8.3 kV circuit has a 20,000 A (rms sym.) fault current available. Extend a line upward on the curve in Figure 7 and note that there would be an unlimited maximum fault current of 48,000 peak amperes. Protecting this circuit with a 40 A NX fuse allows a maximum let-through current of 7800 peak amperes. This is equivalent to an unprotected circuit having a maximum fault available of 3200 A (rms sym.).

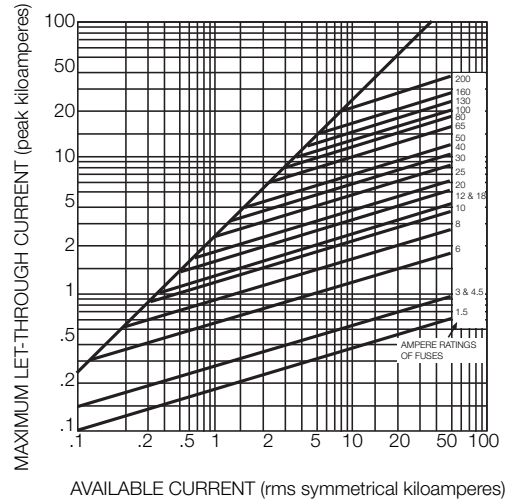

**Figure 7. Maximum let-through current for NX current-limiting fuses – 8.3, 15.5 and 23 kV.**

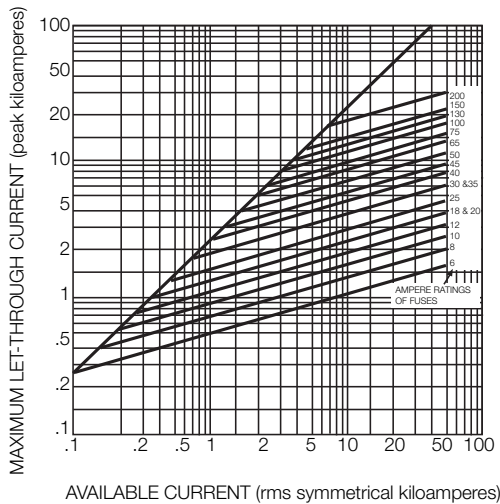

**Figure 6. Maximum let-through current for NX current-limiting fuses – 4.3 and 5.5 kV.**

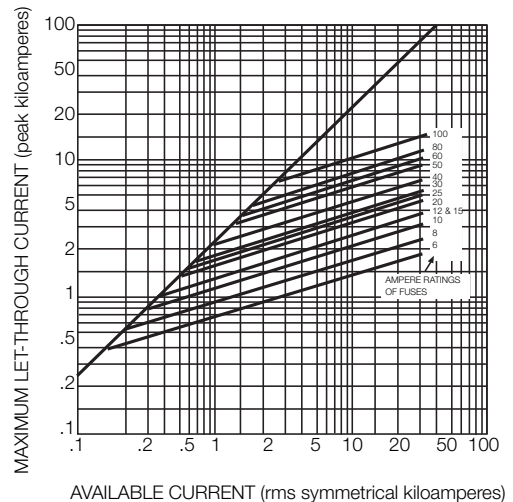

**Figure 8. Maximum let-through current for NX current-limiting fuses – 27 and 38 kV.**

## Application

### Voltage rating selection

To determine the correct voltage rating for a current-limiting fuse, proper consideration must be given to the type of distribution system, the system voltage, the transformer winding connection, and neutral grounding. In general, single-phase fusing permits the use of a fuse with phase-to-neutral voltage rating; whereas, three-phase fusing usually requires a fuse with phase-to phase voltage rating. However, where it is desirable (because of economics, standardization, oil space, etc.), NX fuses with phase-to-neutral voltage ratings may be used on three-phase applications provided certain parameters are met. See "Three-Phase Applications". Allowance is normally given for voltages slightly exceeding the normal system voltage. (Standards consider the maximum service voltage as 5 to 6% over normal.) Since each current-limiting fuse has a maximum design voltage, application must be such that the post-interruption voltage impressed across the fuse does not exceed that maximum design voltage.

Table 7 lists the recommended voltage ratings for current-limiting fuses applied on the most commonly encountered distribution systems.

### Ampere rating selection

Another consideration in the selection of a current-limiting fuse is the ampere rating. The rating must be such that the inrush currents that can occur in a transformer will not cause the fuse to operate.

Two rules of thumb should be used for this consideration:

A fuse should be able to withstand 12 times the transformer-rated current for 0.1-second without element damage.

The element must be able to withstand 25 times the transformer-rated current for one-half cycle.

This second rule was established because of the magnitude of the first loop of inrush current which can far exceed 12 times the transformer rated current and thus cause element damage and the steep slope in the melting characteristics of the current-limiting fuse. Because TCC curves only extend down to the 0.01-second melt time, it is satisfactory to compare the 25 times rated current to the 0.01-second minimum melt of a fuse. This will provide only a slightly more conservative comparison than using the 0.0083-second value. Although, theoretically, higher values of inrush current are possible, test data and field experience indicate that they are quite unlikely to exceed this value.

The second consideration for selecting the fuse amperage rating is the maximum load current that the fuse is expected to carry without fuse damage. This includes the allowable transformer overloading for certain periods of time. Transformer fusing tables normally list the ranges of overload provided. If the long-time minimum-melt current is known for the fuse size in question, it can be compared to the transformer-rated current to determine the exact percentage of overload permitted. Since fuse heating plus transformer heating would probably raise the ambient temperature for the fuse, the long-time minimum-melt current should be reduced accordingly. An ambient of 40°C is often assumed for this condition. Of course, the proposed current-limiting fuse must be capable of carrying such currents without damage, and it must interrupt minimum-melt currents and all higher values.

**Table 7. Recommended Current-Limiting Fuse Voltage Ratings**

System Voltage (kV)		Recommended NX Fuse Rating (kV)			
Nominal	Maximum	Four-Wire Multi-Grounded Neutral		Delta	
		Single-Phase	Three-Phase	Single-Phase	Three-Phase
2.4	2.54	—	—	4.3	4.3
2.4/4.16	2.54/4.4	4.3	5.5*	—	—
4.16	4.4	—	—	4.3	4.3
4.8	5.1	—	—	5.5	5.5
4.8/8.32	5.1/8.8	5.5	8.3*	—	—
6.9	7.26	—	—	8.3	8.3
6.93/12	7.3/12.7	8.3	15.5*	—	—
7.2	7.62	—	—	8.3	8.3
7.2/12.47	7.62/13.2	8.3	15.5*	—	—
7.97	8.4	—	—	8.3	8.3
7.97/13.8	8.4/14.5	8.3	15.5*	—	—
8.32	8.8	—	—	8.3	8.3
8.32/14.4	8.8/15.2	8.3	15.5*	—	—
12/20.8	12.7/22	15.5	23*	—	—
12.47	13.2	—	—	15.5	15.5
13.2/22.9	14/24.2	15.5	23*	—	—
13.2	14.5	—	—	15.5	15.5
14.4/24.9	15.2/26.4	15.5	27*	—	—
14.4	15.2	—	—	15.5	15.5
19.9/34.5	21.1/36.5	23	38*	—	—
34.5	36.5	—	—	38	38

\* A line-to-neutral rating may be used if certain parameters are met.

Transformer primary fuses are not usually applied to coordinate with the ANSI transformer safe-loading requirement; namely, melting at 300% kVA rating in 5 minutes and sensing 200% kVA in about 30 minutes. This duty would require a fuse size that would be subject to inrush-current damage. In addition, it would respond too rapidly to short-time, high overloads. Common practice is to fuse to interrupt overload currents in the 200 to 300% range after several hours' duration. Specification recommendations are shown in Tables 8 and 9.

**Table 8. Overload Protection of Oil-Insulated – Self-Cooled, and Dry-Type Transformers<sup>1</sup> (Single-Phase Application)**

		Nominal Single-Phase Voltage Across Transformer Terminals (kV)																		
		2.4		4.16		4.8		7.2-7.96		12-12.47		13.2-14.4		19.9		24.9		34.5		
Transformer (kVA)	Recommended Fuse Voltage (kV)																			
	4.3		4.3		5.5		5.5		8.3		15.5		15.5		23		27		38	
	Recommended Fuse-Current Ratings (amperes) <sup>2, 5</sup>																			
Column A – 140-200% Transformer Rating																				
Column B – 200-300% Transformer Rating																				
	A	B	A	B	A	B	A	B	A	B	A	B	A	B	A	B	A	B	A	B
1.5		18 <sup>3</sup>		18 <sup>3</sup>		6 <sup>3</sup>		6 <sup>3</sup>		1.5 <sup>3</sup>		1.5 <sup>3</sup>		1.5 <sup>3</sup>		6 <sup>3</sup>		6 <sup>3</sup>		6 <sup>3</sup>
3		18 <sup>3</sup>		18 <sup>3</sup>		6 <sup>3</sup>		6 <sup>3</sup>		1.5 <sup>3</sup>		1.5 <sup>3</sup>		1.5 <sup>3</sup>		6 <sup>3</sup>		6 <sup>3</sup>		6 <sup>3</sup>
5		18 <sup>3</sup>		18 <sup>3</sup>		6 <sup>3</sup>		6 <sup>3</sup>		1.5 <sup>3</sup>		1.5 <sup>3</sup>		1.5 <sup>3</sup>		6 <sup>3</sup>		6 <sup>3</sup>		6 <sup>3</sup>
7.5		18 <sup>3</sup>		18 <sup>3</sup>		6 <sup>3</sup>		6 <sup>3</sup>		1.5 <sup>3</sup>		1.5 <sup>3</sup>		1.5 <sup>3</sup>		6 <sup>3</sup>		6 <sup>3</sup>		6 <sup>3</sup>
10		18 <sup>3</sup>		18 <sup>3</sup>		6 <sup>3</sup>		6 <sup>3</sup>		3 <sup>3</sup>		1.5		1.5 <sup>3</sup>		6 <sup>3</sup>		6 <sup>3</sup>		6 <sup>3</sup>
15		18 <sup>3</sup>		18 <sup>3</sup>		6		6		3		3		1.5		6 <sup>3</sup>		6 <sup>3</sup>		6 <sup>3</sup>
25		18		18 <sup>3</sup>		10		8		6		3		3		6 <sup>3</sup>		6 <sup>3</sup>		6 <sup>3</sup>
37.5		25		18 <sup>3</sup>		18		12		10		6		6		6 <sup>3</sup>		6 <sup>3</sup>		6 <sup>3</sup>
50	25	45	18	25		20		18		12		8		6		6 <sup>3</sup>		6 <sup>3</sup>		6 <sup>3</sup>
75	45	75	25	35	25	30		25		18		10		10		8		6		6 <sup>3</sup>
100	50	100	35	50	30	50	25	40		25		12		12		10		8		6
150	100	150	45	100	50	75	40	65	25	40	18	25	18	20		12		10		8
167	100	150	50	100	50	75	50	75	30	50	20	30	18	25	12	18		12		10
200	130	200	65	130	75	100	50	75	30	65	25	40	20	30	12	20	12	15		12
250	150	200	75	150	75	130	65	100	40	80	30	50	25	40	18	25	15	20		12
333	200		130	200	100	150	100	150	65	100	30	65	30	50	25	40	20	30		15
500			150		150		130		100	160	50	100	50	80	30		30	50	20	30
750			200 <sup>4</sup>						130	200	80	130	80	130	40 <sup>4</sup>		40	60	30	50
1000									200		100	200	100	160			60	100	40	60
1250									200 <sup>4</sup>		130	200	130	160			80	100	50	80
1500										200		160					80		60	100
1667										200		160					100		60	100
2000										200		160 <sup>4</sup>					100 <sup>4</sup>		80	100
2500																			100	
3000																			100 <sup>4</sup>	

**Notes:**

1. Recommendations are based on fuse-melting characteristics at an ambient temperature of 40°C (See R240-60-2).
2. To prevent fuse blowing on transformer inrush, DO NOT USE FUSES SMALLER THAN RECOMMENDED without specific approval of the manufacturer.
3. Fuses allow in excess of 300% of load.
4. Fuses allow less than 140% of load.
5. Ratings in shaded area are for parallel-fuse combinations.

**Table 9. Overload Protection of Oil-Insulated – Self-Cooled, and Dry-Type Transformers<sup>1</sup> (Three-Phase Application)**

Nominal Three-Phase Voltage Across Transformer Terminals																						
2.4      4.16      4.8      7.2-7.96      8.32      12.47      13.2-14.4      20.8      22.9-24.9      34.5																						
Recommended Fuse Voltage (kV)																						
4.3      4.3      5.5      5.5      8.3      15.5      15.5      15.5      23      27      38																						
Recommended Fuse-Current Ratings (amperes) <sup>2, 5</sup>																						
Column A–140-200% Transformer Rating																						
Column B–200-300% Transformer Rating																						
Transformer (kVA)	A		B		A		B		A		B		A		B		A		B			
	A	B	A	B	A	B	A	B	A	B	A	B	A	B	A	B	A	B	A	B		
15		18 <sup>3</sup>		18 <sup>3</sup>		6 <sup>3</sup>		6 <sup>3</sup>		1.5		1.5		1.5		1.5		6 <sup>3</sup>		6 <sup>3</sup>		6 <sup>3</sup>
22.5		18 <sup>3</sup>		18 <sup>3</sup>		6 <sup>3</sup>		6 <sup>3</sup>		3		3		1.5		1.5		6 <sup>3</sup>		6 <sup>3</sup>		6 <sup>3</sup>
30		18 <sup>3</sup>		18 <sup>3</sup>		8		6		4.5		4.5		3		3		6 <sup>3</sup>		6 <sup>3</sup>		6 <sup>3</sup>
45		18		18 <sup>3</sup>		10		10		6		6		3		3		6 <sup>3</sup>		6 <sup>3</sup>		6 <sup>3</sup>
75	25	35		18	12	20	12	18		10		10		6		6		6 <sup>3</sup>		6 <sup>3</sup>		6 <sup>3</sup>
100	35	50		25	20	25	18	25	12	18		12		10		8		6		6 <sup>3</sup>		6 <sup>3</sup>
112.5	45	65		25	25	30	18	30	12	18		12		10		10		6		6		6 <sup>3</sup>
150	50	100	25	45	25	40	25	40	18	25		18		12		12		8		8		6 <sup>3</sup>
200	65	100	45	65	40	65	30	50	20	30	18	25		18	12	18		10		10		6 <sup>3</sup>
225	75	130	45	75	40	75	40	65	25	40	20	30		18	12	20		10		10		8
300	100	200	50	100	50	75	50	75	30	50	25	50	20	25	18	25		12		12		10
500	200		100	150	100	150	75	130	50	100	50	80	30	50	30	50	20	25	18	25		15
750	200 <sup>4</sup>		130	200	130		130		80	130	65	130	40	80	40	80	25	40	25	40	18	25
1000			200		150 <sup>4</sup>		150		100	160	100	160	65	100	65	100	30		30	50	25	30
1500									160	200	130	200	100	160	80	160	40 <sup>4</sup>		50	80	30	50
2000									200		200		130	200	130	160			60	100	40	60
2500										200 <sup>4</sup>		160	200	160					80		50	100
3000												200		160					100		60	100
3500												200		160 <sup>4</sup>					100 <sup>4</sup>		80	100
3750												200 <sup>4</sup>							100 <sup>4</sup>		80	
4000												200 <sup>4</sup>									80	
5000																					100	

- Notes:**
1. Recommendations are based on fuse-melting characteristics at an ambient temperature of 40°C (See R240-60-2).
  2. To prevent fuse blowing on transformer inrush, DO NOT USE FUSES SMALLER THAN RECOMMENDED without specific approval of the manufacturer.
  3. Fuses allow in excess of 300% of load.
  4. Fuses allow less than 140% of load.
  5. Ratings in shaded area are for parallel-fuse combinations.



**Derating NX fuses—raised ambient temperatures**

To determine the proper NX fuse size for carrying desired current and percent overload available at raised ambient temperatures, the minimum-melt current must be derated. The curves in Figure 9 show the derating factors for NX fuse applications at raised ambient temperatures in air, in canisters suspended in oil, and in transformer bushings. (These curves are based on a six-hour melting time, not the maximum pre-melt current.)

By using these curves in conjunction with minimum-melt current values from the minimum-melting characteristic table for NX fuses, Table 10, which is based on a 25°C ambient temperature and a six-hour melting time, the proper fuse size can be determined.

**Example**

To derate the minimum-melt current of a 5.5 kV, 20 A NX fuse mounted in free air at a raised ambient temperature of 75°C:

1. On Figure 9, draw a vertical line at 75°C to intersect the free-air curve.
2. From the intersection point, draw a horizontal line to the vertical axis to determine the derating factor which, in this case, is 79%.
3. From Table 10, find the minimum-melt current for the 5.5 kV, 20 A fuse which, in this case, is 28 A.
4. Multiply this value by the derating factor to determine the derated minimum-melt current: 28 A x .79 = 22 A.

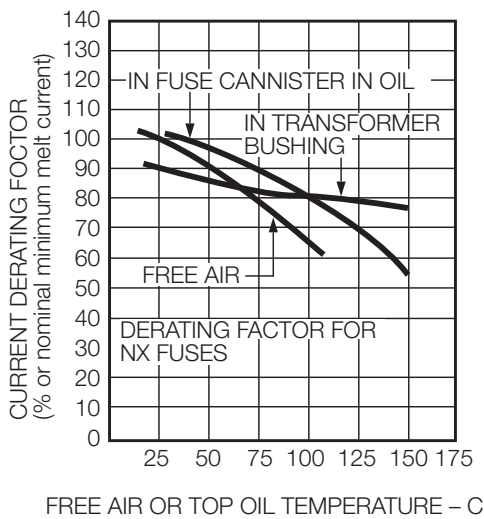

**Figure 9. Derating curves for NX fuse application at raised ambient temperatures.**

**Ordering information**

To order a clip-style mounting NX fuse and the hinge-style fuse, first determine the voltage rating (Table 7) and amperage ratings of the fuse(s) (Table 8 & Table 9) device, and then select the appropriate catalog number from Table 11 or 12. For parallel fusing, order two fuses.

To order an NX hinge-style switchblade, choose the appropriate catalog number from Table 13.

**Table 10. Minimum-Melting Characteristic for NX Current-Limiting Fuses Based on a 25°C Ambient Temperature and a Six-Hour Melting Time**

Voltage Rating (kV)	Continuous Current Rating (amp)	Minimum Melt Current (Amp)	Voltage Rating (kV)	Continuous Current Rating (amp)	Minimum Melt Current (Amp)	
4.3	18	27	15.5	1.5	2.3	
	25	37		3	4.5	
	35	50		4.5	6.7	
	45	64		6	9	
	50	68		8	12	
	65	78		10	15	
	75	90		12	18	
	100	110		18	26	
	130*	156		20	28	
	150*	180		25	35	
	200*	220		30	41	
	6	9		40	52	
8	12	50	63			
10	14	50*	70			
12	17	60*	82			
18	27	65	80			
20	28	80	96			
25	37	80*	104			
30	42	100	120			
40	55	100*	126			
50	68	130*	160			
65	78	160*	192			
75	90	200*	240			
100*	136	6	9			
130*	156	8	12			
150*	180	10	15			
5.5	1.5	2.3	23	12	18	
	3	4.5		18	26	
	4.5	6.7		20	28	
	6	9		25	35	
	8	12		30	41	
	10	14		40	52	
	12	17		6	9	
	18	26		8	12	
	20	28		10	15	
	25	35		12	18	
	30	41		15	22	
	40	52		18	26	
50	63	20	28			
50*	70	25	35			
60*	82	30	41			
65	80	40	52			
80	96	50	63			
80*	104	60*	82			
100	120	80*	104			
100*	126	100*	126			
130*	160	27 and 38				
160*	192					
200*	240					
8.3	1.5		2.3	27 and 38		
	3		4.5			
	4.5		6.7			
	6		9			
	8		12			
	10	14				
	12	17				
	18	26				
	20	28				
	25	35				
	30	41				
	40	52				
50	63					
50*	70					
60*	82					
65	80					
80	96					
80*	104					
100	120					
100*	126					
130*	160					
160*	192					
200*	240					

\* Indicates parallel fuses.

**Table 11. NX Clip-Style Current-Limiting Fuse (Refer to Figure 2) Rating\***

Voltage (kV)	Continuous Current (A)	Mounting Code Number	Fuse Diameter (in.)	Catalog Number
4.3	18	4	1.125	FA1H18
	25	4	1.125	FA1H25
	35	4	1.125	FA1H35
	45	4	2	FA1H45
	50	4	2	FA1H50
	65	4	2	FA1H65
	75	4	2	FA1H75
5.5	105	4	2	FA1H100
	6	4	1.125	FA2H6
	8	4	1.125	FA2H8
	10	4	1.125	FA2H10
	12	4	1.125	FA2H12
	18	4	1.125	FA2H18
	20	4	2	FA2H20
	25	4	2	FA2H25
	30	4	2	FA2H30
	40	4	2	FA2H40
	50	4	2	FA2H50
	65	4	2	FA2H65
	75	4	2	FA2H75
8.3	1.5	4	1.125	FA3H1
	3	4	1.125	FA3H3
	4.5	4	1.125	FA3H4
	6	4	1.125	FA3H6
	8	4	1.125	FA3H8
	10	4	1.125	FA3H10
	12	4	1.125	FA3H12
	18	4	2	FA3H18
	20	4	2	FA3H20
	25	4	2	FA3H25
	30	4	2	FA3H30
	40	4	2	FA3H40
	50	5	3.438	FA3H50
65	5	3.438	FA3H65	
80	5	3.438	FA3H80	
100	5	3.438	FA3H100	
15.5	1.5	5	1.125	FA4H1
	3	5	1.125	FA4H3
	4.5	5	1.125	FA4H4
	6	5	2	FA4H6
	8	5	2	FA4H8
	10	5	2	FA4H10
	12	5	2	FA4H12
	18	5	2	FA4H18
	20	5	2	FA4H20
	25	5	2	FA4H25
	30	5	2	FA4H30
	40	5	2	FA4H40
	50	6	3.438	FA4H50
65	6	3.438	FA4H65	
80	6	3.438	FA4H80	
100	6	3.438	FA4H100†	

**Table 11. NX Clip-Style Current-Limiting Fuse (Refer to Figure 2) continued Rating\***

Voltage (kV)	Continuous Current (A)	Mounting Code Number	Fuse Diameter (in.)	Catalog Number
23	6	6	2	FA5H6
	8	6	2	FA5H8
	10	6	2	FA5H10
	12	6	2	FA5H12
	18	6	2	FA5H18
	20	6	2	FA5H20
	25	6	2	FA5H25
	30	6	2	FA5H30
	40	6	2	FA5H40
	27	6	9	3.438
8		9	3.438	FA9H8
10		9	3.438	FA9H10
12		9	3.438	FA9H12
15		9	3.188	FA9H15
18		9	3.438	FA9H18
20		9	3.438	FA9H20
25		9	3.438	FA9H25
30		9	3.438	FA9H30
40		9	3.438	FA9H40
38	50	9	3.438	FA9H50
	6	10	3.438	FA10H6
	8	10	3.438	FA10H8
	10	10	3.438	FA10H10
	12	10	3.438	FA10H12
	15	10	3.438	FA10H15
	18	10	3.438	FA10H18
	20	10	3.438	FA10H20
	25	10	3.438	FA10H25
	30	10	3.438	FA10H30
40	10	3.438	FA10H40	
50	10	3.438	FA10H50	

\* 4.3, 5.5, 8.3, 15.5, 23 kV have 50,000 A symmetrical rating, 27 and 38 kV have 35,000 A symmetrical rating.

\*\* Code number of mounting must match code number of fuse or switchblade.

**Note:** Fuse extenders available as follows:

Catalog Number FEXT45 adapts Code 4 fuses to Code 5 mountings

Catalog Number FEXT56 adapts Code 5 fuses to code 6 mountings

**Table 12. NX Hinge-Style Current-Limiting Fuses (with Arc-Strangler Loadbreaking Device) (Refer to Figures 4 and 5)**

Rating				
Voltage (kV)	Continuous Current (A)	Mounting Code Number*	Fuse Diameter (in.)**	Catalog Number
<b>For Single- and Parallel-Unit Hinge-Style Mountings</b>				
4.3***	18	1	1.125	FA1A18
	25	1	1.125	FA1A25
	35	1	1.125	FA1A35
	45	1	2	FA1A45
	50	1	2	FA1A50
	65	1	2	FA1A65
	75	1	2	FA1A75
	100	1	2	FA1A100
5.5	6	1	1.125	FA2A6
	8	1	1.125	FA2A8
	10	1	1.125	FA2A10
	12	1	1.125	FA2A12
	18	1	1.125	FA2A18
	20	1	2	FA2A20
	25	1	2	FA2A25
	30	1	2	FA2A30
	40	1	2	FA2A40
	50	1	2	FA2A50
65	1	2	FA2A65	
75	1	2	FA2A75	
8.3***	1.5	1	1.125	FA3A1
	3	1	1.125	FA3A3
	4.5	1	1.125	FA3A4
	6	1	1.125	FA3A6
	8	1	1.125	FA3A8
	10	1	1.125	FA3A10
	12	1	1.125	FA3A12
	18	1	2	FA3A18
	20	1	2	FA3A20
	25	1	2	FA3A25
30	1	2	FA3A30	
40	1	2	FA3A40	
15.5***	1.5	2	1.125	FA4A1
	3	2	1.125	FA4A3
	4.5	2	1.125	FA4A4
	6	2	2	FA4A6
	8	2	2	FA4A8
	10	2	2	FA4A10
	12	2	2	FA4A12
	18	2	2	FA4A18
	20	2	2	FA4A20
	25	2	2	FA4A25
30	2	2	FA4A30	
40	2	2	FA4A40	

\* Code number of mounting must match code number of fuse or switchblade.

\*\* All 2" diameter fuses have magniformed end fittings with stamped hinge.

\*\*\* Consult factory for 90° and 180° stop configurations.

**Table 13. NX Hinge-Style Switchblades (with Arc-Strangler Loadbreaking Devices) (Refer to Figure 3)**

Rating				
Voltage (kV)	Continuous and Loadbreak Current (A)	Description	Mounting Code Number*	Catalog Number
8.3	200	Blade	1	FA1B1
15.5	200	Short 15 kV blade	1	FA4B1
15.5	200	Long 15 kV blade	2	FA8B1

\* Code number of mounting must match code number of fuse or switchblade.

## Additional literature

Eaton has additional reference information available on NX fuses.

R240-60-2	NX Current-Limiting Fuses, Minimum Melting Characteristics
R240-60-3	Coordination of NX Fuses With EEI-NEMA® Fuse Links
R240-60-5	Maximum Total and Minimum Melt Comparison of NX Fuses
R240-60-6	Mounting Clearances—Type NX Fuses
R240-60-7	Parallel Operation of NX Fuses
R240-60-8	A Guide to Secondary Cable Fault Clearing With NX Fuses
R240-60-9	Properties of Molded Box for NX Fuses With Arc-Strangler Switch
R240-60-11	Specifications—NX Fuses With Arc-Strangler Switch
R240-60-13	NX Fuse Recommended Transformer Applications

**Eaton**  
1000 Eaton Boulevard  
Cleveland, OH 44122  
United States  
Eaton.com

**Eaton's Power Systems Division**  
2300 Badger Drive  
Waukesha, WI 53188  
United States  
Eaton.com/cooperpowerseries

© 2019 Eaton  
All Rights Reserved  
Printed in USA  
Publication No. CA132049EN  
September 2019

Eaton is a registered trademark.

All other trademarks are property of their respective owners.

For Eaton's Cooper Power series product information call 1-877-277-4636 or visit: [www.eaton.com/cooperpowerseries](http://www.eaton.com/cooperpowerseries).