

Low-voltage power distribution and control systems > Switchgear >

Arc-resistant Magnum DS low-voltage switchgear (ArcGard)

Contents

General Description	20.2-2
Product Description	20.2-2
Devices	20.2-8
Circuit Breakers	20.2-8
Meters	20.2-13
Communications	20.2-14
Automatic Transfer	20.2-14
High Resistance Grounding	20.2-15
Layouts and Dimensions	20.2-16
Breaker Layouts	20.2-16
Structure Dimensions	20.2-23
Application Data	20.2-30



Powering Business Worldwide

Product Description

Arc-Resistant Switchgear



Arc-Resistant Switchgear

Arc-resistant low-voltage switchgear protects operating and maintenance personnel from dangerous arcing faults by channeling the arc energy out the top of the switchgear. Arc faults, caused by human error or insulation failure, can generate thermal energy as high as 35,000 °F and a blast equivalent to 20.7 lb of TNT. While arc-resistant gear does not prevent these arcs from occurring, it does safely redirect and contain arcs that do occur, regardless of the originating location of the arc. ArcGard Magnum DS switchgear has been tested in all three compartments for a full 0.5 seconds, passing ANSI Type 2 and Type 2B standards at 100 kA at 508 V and 85 kA at 635 V. Indoor rear access construction and indoor front access construction are available as arc-resistant Type 2B.

Accessibility Types

Eaton arc-resistant switchgear is Type 2B.

Arc-resistant switchgear performance is defined by its accessibility type in accordance with IEEE test guide C37.20.7 as follows:

Type 1: Switchgear with arc-resistant designs or features at the freely accessible front of the equipment only.

Type 2: Switchgear with arc-resistant designs or features at the freely accessible exterior (front, back and sides) of the equipment only. (Type 2 incorporates Type 1.)

Type 2B: Switchgear with Type 2 accessibility plus arc-resistant in front of the instrument/control compartment with the instrument/control compartment door opened. (Type 2B incorporates Type 2.)

Normal Operating Conditions

Eaton arc-resistant switchgear is Type 2B. Instrument/control compartment door and breaker secondary door can be open and maintain Type 2B protection.

Arc-resistant features are intended to provide an additional degree of protection to the personnel performing normal operating duties in close proximity to the equipment while the equipment is operating under normal conditions.

The normal operating conditions for proper application of arc-resistant switchgear designs are as follows:

- All breaker doors and rear covers are properly closed and latched
- Pressure relief devices are free to operate
- The fault energy available to the equipment does not exceed the rating of the equipment (short-circuit current and duration)
- There are no obstructions around the equipment that could direct the arc fault products into an area intended to be protected
- The equipment is properly grounded

The user should also refer to documents such as NFPA 70E, for safety training and safe work practices and methods of evaluating safe work distances from energized equipment based on the potential flash hazard, and use proper PPE when working on or near energized equipment with the door/cover opened or not properly secured.

Product Offering

Arc-resistant switchgear comes standard with:

- Type 2B construction, including breaker secondary compartment
- Up to 100 kA short circuit at 508 Vac maximum and 85 kA short circuit at 635 Vac maximum
- Up to 10 kA horizontal main bus continuous current
- Up to 5 kA vertical bus continuous current
- Magnum DS power circuit breaker frame ratings between 800 A and 6000 A
- Up to four high breaker configuration
- Requires 10-foot equipment base to ceiling clearance
- Additional safety without increasing the footprint of regular Magnum DS switchgear
- Indoor rear access construction available
- Indoor front access construction available

Standard Features

- **ANSI Type 2B arc-resistance:** Type 2B arc-resistant switchgear regardless of whether the arc originates in the breaker, bus or cable compartment
- **Stronger door and latch:** The robust doors are made of heavy 12 gauge metal and secured with two-point latches



Bellows and Two-Point Door Latch

- **Breaker bellows:** Bellows surround the breaker door, preventing arc gasses from escaping around the nose of the breaker while ensuring easy racking of the breaker into the disconnected position
- **Rear dynamic flap system:** The ventilation openings in the breaker are open during operation to allow proper equipment ventilation, and then sealed off during an arc event. The rear dynamic flap system uses gravity to keep the flaps open during normal operating conditions and the arc pressure wave to close the flaps during an arcing event. The design is such that there are no electrical parts that could break or fail



Rear Dynamic Flap System

- **Ventilation system:** Each breaker compartment is vented to allow ionized gas to flow into the bus compartment from any location in the switchgear and then exit the switchgear through the hinged flaps
- **Bottom or top cable or bus duct entry**
- **Cable compartment floor plates**

Optional Features

- **Plenum:** The plenum is mounted on top of arc-resistant gear to direct dangerous arc gasses as they leave the switchgear. The exit path can either be a side or rear exit, with a 4-foot blast zone around the exit
- **Zone selective interlocking protection:** Zone selective interlocking capability is also available in arc-resistant gear, allowing the breaker closest to the fault to trip without any preset time delay while the remainder of the distribution system remains online
- **Arcflash Reduction Maintenance System™**
- **Safety shutters**
- **One piece hinged and bolted rear panel**
- **Insulated bus**
- **Vented bus/cable compartment barriers:** Bus/cable compartment barriers are only available vented to allow flow of arc gasses in the case of an arc event
- **Cable compartment segregation barrier**

Standards and Certifications

- UL 1558/UL 1066
- ANSI C37.20.1, C37.13, C37.51
- ANSI C37.20.7
- CSA C22.2 No 31-04
- Third-party UL witnessed and certified

Ratings

Table 20.2-1. Voltage Ratings (AC)

System Voltage	Maximum Voltage
208/240	254
480	508
600	635

Table 20.2-2. Available Bus Ratings

Cross Bus Ampacity	Bus Bracing kA
2000 3200 4000	100, 150
5000 6000 8000 10,000	100, 150

Overview

Eaton's Magnum DS® power circuit breaker switchgear is backed by 40 years of power circuit breaker and switchgear development that have set the industry standards for quality, reliability, maintainability and extended operating life, when it comes to protecting and monitoring low-voltage electrical distribution systems. Magnum DS switchgear is designed to meet the changing needs of our customers by providing:

- Lower installation and maintenance costs
- Higher interrupting ratings and withstand ratings
- Better coordination capability
- Increased tripping sensitivity
- Enhanced safety measures
- Higher quality, reliability and maintainability
- Communications and power quality monitoring and measuring capabilities
- Flexible layouts that maximize use of capital by minimizing equipment footprint

Magnum DS switchgear can meet the needs of general applications, service entrances, harsh environments, multiple source transfers, special grounding systems and many others.

With a modern design, Magnum DS metal-enclosed low-voltage switchgear and power circuit breakers provide:

- 100% rated, fully selective protection
- Integral microprocessor-based breaker tripping systems
- Two-step stored-energy breaker closing
- Standard 100 kA short-circuit bus bracing
- Optional 150 kA short-circuit bus bracing
- Optional metal barriers to isolate the cable compartment from the bus compartment
- Full range of safety solutions dealing with arc flash hazard and operator error

Many other features for coordinated, safe, convenient, trouble-free, and economical control and protection of low-voltage distribution systems are also provided.

Magnum DS breakers are designed to:

- ANSI Standards C37.13, C37.16, C37.17, C37.50
- UL 1066

Magnum DS switchgear conforms to the following standards:

- CSA® C22.2, No. 31-10
- ANSI C37.20.1
- ANSI C37.20.7
- ANSI C37.51
- UL® Standard 1558
- American Bureau of Shipping (ABS)
- Built in an ISO® certified facility

Maximum ratings for Magnum DS switchgear are 600 Vac, 10,000 A continuous cross bus.

Seismic Qualification



Refer to www.eaton.com/seismic for information on seismic qualification for this and other Eaton products.

Structure Features

Standard finish: Gray paint finish (ANSI 61) using a modern, completely automated and continuously monitored electrostatic powder coating. This continually monitored system includes spray de-grease and clean, spray rinse, iron phosphate spray coating spray rinse, non-chemical seal, oven drying, electrostatic powder spray paint coating and oven curing.

Integral base: The ruggedly formed base greatly increases the rigidity of the structure, reduces the possibility of damage during the installation of the equipment, and is suitable for rolling, jacking and handling. A lifting angle is permanently welded into the bus compartment structure for increased strength. The bottom frame structure members are indented to allow the insertion of a pry bar.

Heavy-duty door hinges: Allow easy access to the breaker internal compartment for inspection and maintenance.

Rear cover/doors: In Magnum DS switchgear, standard rear bolted covers are provided. They are split into two sections to facilitate handling during removal and installation. Optional rear doors are also available.

Through-the-door design: The following functions may be performed without the need to open the circuit breaker door—lever the breaker between positions, operate manual charging system and view the spring charge status flag, close and open breaker, view and adjust trip unit and read the breaker rating nameplate.



Through-the-Door Design

Cassette design: The breaker cassette supports the breaker in the cell, as well as on the movable extension rails when the breaker is placed into or removed from the cell. The extension rails allow the breaker to be drawn out without having to de-energize the entire switchgear lineup.

Accessibility: When the door is open or removed, each breaker compartment provides front access to isolated, vertical wireways, primary disconnects, cell current transformers and other breaker compartment accessories for ease of field wiring and troubleshooting field connections.

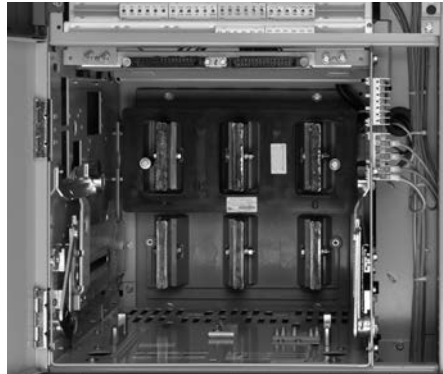

Breaker Cell

Four-position drawout: Breakers can be in connected, test, disconnected or removed position. The breaker can be moved between the connected, test and disconnected positions while the compartment door is closed.

Closing spring automatic discharge: Mechanical interlocking automatically discharges the closing springs when the breaker is removed from its compartment.

Optional safety shutters: Positive acting safety shutters that isolate the breaker connections to the main bus when the breaker is withdrawn from the cell is an option offered for additional safety beyond our standard design. They reduce the potential of accidental contact with live bus. Insulating covers ("boots") are furnished on live main stationary disconnecting contacts in compartments equipped for future breakers.

Breaker inspection: When withdrawn on the rails, breaker is completely accessible for visual inspection; tilting is not necessary. The rails are permanent parts of every breaker compartment.

interlocks: Supplied on breakers and in compartments where the compartments are of the same physical size. Interference interlocks ensure an incorrect breaker cannot be inserted.

Optional key interlock (switchgear mounted): This mechanism holds the breaker cell mechanically trip-free to prevent electrical or manual closing. Breaker can be stored in compartment, and completely removed for maintenance or for use as a spare without disturbing the interlock. Modification of the breaker is not required.

Optional mechanical interlock: Available between adjacent breakers to ensure the proper sequence of operation between two circuit breakers.

Bus Features

Buses and connections: Vertical and cross bus ratings in Magnum DS switchgear are based on a UL and ANSI standard temperature rise of 65 °C above a maximum ambient air temperature of 40 °C.

Bus ampacities: Vertical and main bus ratings in Magnum DS are 2000, 3200, 4000 and 5000 A. In addition, a 6000, 8000 and 10,000 A main bus rating is available. Vertical section bus is sized per main cross bus maximum rating or by ANSI C37.20.1 to a maximum of 5000 A.

Bus bracing: Standard bracing is 100,000 A. The "U" shaped bar is the heart of the Magnum DS vertical bus. This configuration provides a much higher mechanical strength. To further demonstrate the strength and rigidity of this bus system, it has been verified through testing to withstand 85,000 A short-circuit for a full 60 cycles.

Silver and tin plating: Bolted, silver-plated copper bus is standard. The plating is over the entire length of the bar, not just at the joints. Optional tin-plated copper bus is available.

Bus joints: All joints are bolted and secured with Belleville-type spring washers for maximum joint integrity. These washers reduce the potential of joint hardware loosening during the change of joint temperature associated with variations of the loads. Optional maintenance-free hardware is also available.

Full neutral: For four-wire applications, the neutral bus is rated 100% of main bus rating as standard. Neutral ratings up to a maximum of 10,000 A are available as an option. Additionally, four-pole breakers can be used in conjunction with four-wire systems.

Ground: A ground bus is furnished the full length of the switchgear assembly and is fitted with terminals for purchaser's connections.

Glass reinforced polyester and Ultramid® standoff insulation system: Glass reinforced polyester has been used on both low and medium voltage switchgear for decades. By combining this industry proven material with Ultramid insulation, a total system providing exceptional mechanical and dielectric withstand strength, as well as high resistance to heat, flame and moisture, is produced. Substantial testing to demonstrate accelerated effects of heating and cooling on the mechanical and dielectric properties of this system prove it to provide superior performance for decades of trouble-free operation.

Optional epoxy bus coating: For applications requiring additional bus protection in harsh environments, Magnum DS switchgear is designed for the addition of optional conductor insulation covering, in addition to providing full UL air clearance without insulation. This material is applied during the assembly of the bus, and covers all vertical and horizontal phase bus bars. Removable boots provide access to section-to-section bus joints for inspection and maintenance purposes.

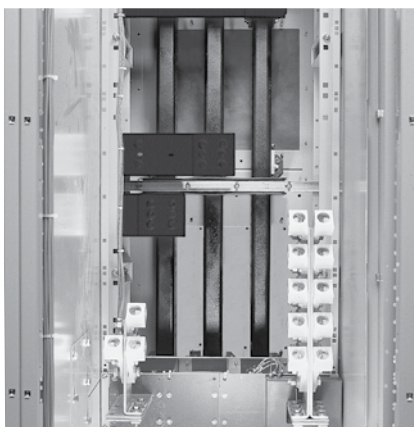

Optional Insulated Bus

Barriers: Optional grounded metal barriers isolate the main bus and connections from the cable compartment providing added safety to the workers while reducing the potential of objects falling into the bus compartment. In addition, vertical barriers between cable sections can be added to reduce potential hazards. Barriers are removable to give access to the bus compartment for inspection and maintenance. Barriers can be either solid metal or vented for ease of infrared scanning.



Optional Bus Compartment and Vertical Section Barriers

Wiring Features

Cable compartment: The cable compartment gives ample room for terminating the power cables. Removable top roof sheets allow for easy conduit hub installation. The floor of the cable compartment is open to allow cable entry from underground duct banks. Optional floor plates are available.

In addition to cable, Pow-R-Way® busway and nonsegregated bus duct can be terminated in the compartment.

Lug pad: The lugs are located on the breaker run-backs to accommodate lug orientations at a 45° angle to reduce the bending radius of the cable needed for making the connections, thus reducing installation and maintenance time. Mechanical setscrew type lugs are standard. Optional NEMA two-hole compression lugs are available as an option.

Control wireway: An isolated vertical wireway is provided for routing of factory and field wiring in each switchgear section. Breaker secondary terminal blocks are mounted as standard above each circuit breaker. The terminal blocks are rated 30 A, and will accept bare wire, ring or spade terminals for wire size ranges of #22–#10. Extruded loops are punched in side sheets of the vertical wireway to allow securing of customer control wiring without the use of adhesive wire anchors.

Control circuits may be wired in all cells without removing the circuit breaker. In addition, power circuits may be connected in the rear of the switchgear at the same time control circuits are being wired in the front of the switchgear.

Control wire: Standard wire is Type SIS insulated stranded copper, extra flexible No. 14 AWG minimum. Type VW-1 wire is available.

Control wire marking: Each wire is imprinted with ink cured under ultraviolet light for durability and for easy identification by the user. The enhanced solvent resistance and durability of the aerospace grade UV cure ink has been tested for severe environments. The imprinting is made every 3.00 inches (76.2 mm) along the length of the wire to make field troubleshooting easier. The point of origin, wire designation and point of destination are imprinted in the following format: <origin zone/wire name/destination zone>. Each device has a uniquely designated zone. "<" indicates the direction of the wire origination and ">" indicates the direction of the wire destination. As an option, wire name marking can be made using sleeve type or heat shrink sleeve type.



Control Wire Marking

Secondary terminal compartment: There are 72 finger-safe secondary connections for a standard frame Magnum breaker, 60 for a narrow frame Magnum breaker and 54 for a Series NRX breaker. The customer's secondary terminal connections are located at the front of the structure behind a separate door providing access to these connections without the need to open the breaker compartment door.

Short-circuiting terminal blocks: One provided for each set of instrumentation or relaying application current transformers.

Shipping split connection: At each shipping split, the control connections are made with plug-in terminal blocks rated 600 V, 40 A. The terminal blocks mechanically interlock without removing the line or load connections. This method of making the shipping split control connections increases the speed of installation and reduces the potential of incorrect connections.

Instrumentation/Metering Features

Flexibility: Magnum DS switchgear allows for a variety of metering options.

See www.eaton.com/CAG for Metering and Power Management products.

- Analog switchboard type meters such as ammeters and voltmeters
- Electronic power metering such as the Power Xpert Meter 4000/6000/8000 series, Power Xpert Meter 2000 series and IQ 250/260 series
- Instrument compartments—white interior panels for ease of visibility

Voltage transformers: Voltage transformers are rated 10 kV BIL, and are protected by both primary and secondary fuses. The primary fuses are of the current limiting type.

Current transformers: Current transformers for metering and instrumentation are mounted in the breaker compartments and are front accessible. Secondary wiring between the current transformer and the standard shorting terminal block is color-coded for ease of identification. Bus mounted CTs are available for metering and relaying.

Control power transformers: Control transformers are provided when required for AC control of circuit breakers, space heaters and/or transformer fans. Like voltage transformers, they are protected by current limiting primary fuses. Non-current limiting fuses are used on the secondary side to protect branch circuits.

Instrumentation—secondary terminal compartment door: Devices, such as control pushbuttons, indicating lights, switches and analog meters can be mounted on these panels, within space limitations.



Devices Mounted on Secondary Terminal Compartment Door

Instrument compartment door: Devices, such as electronic power metering and analog switchboard type meters that do not fit on the secondary terminal compartment door, are mounted on the instrument compartment door or on a panel of a blank cell.

Accessories and Options

Switchgear accessories: Standard accessories furnished with each Magnum DS switchgear assembly include:

- One breaker racking tool
- Insulating covers or “boots” furnished on live main stationary disconnecting contacts in compartments equipped for future breakers
- Removable cover to block opening in the door when the breaker is temporarily removed from its compartment

Optional Accessories

- Traveling type circuit breaker lifter, rail-mounted on top of switchgear
- Floor-running portable circuit breaker lifter and transfer truck with manual lifting mechanism. This requires approximately 84.00 inches (2133.6 mm) deep front aisle space
- Test cabinet for electrically operated breakers, with pushbuttons, control cable and receptacle, for separate mounting
- Optional space heaters to be placed in the bottom of the breaker, cable and bus compartments. Space heaters are provided as standard in outdoor gear to reduce condensation
- Portable test kit (MTK2000) for secondary injection testing and verification of trip units. Uses standard 120 V, 15 A, single-phase, 60 Hz supply, available from any outlet. Allows for testing of Magnum breakers
- Remote racking device (MRR1000) for both breaker racking and operation (open/close) from a safe distance. Mounts to any existing Magnum DS breaker. Uses standard 120 V, 15 A, single-phase, 60 Hz supply, available from any outlet



Magnum Shutter Module

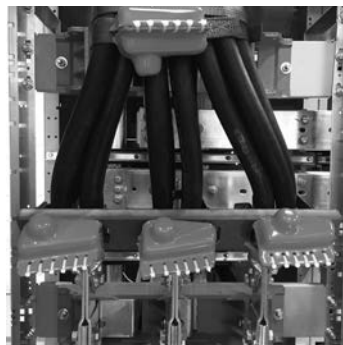

Cable Lashing Device



Optional Switchgear Mounted Lifter



MRR1000 Remote Racking Device

Enhanced Switchgear Options

- Infrared scanning windows for bus thermal scans
- Maintenance-free (Torque-&-Forget) bus hardware
- Lug booting that provides additional protection against accidental contact to live parts in the cable compartment
- Grounding balls and covers for protecting maintenance personnel downstream of switchgear feeder breakers
- Pendant for remote open and close of electrically operated breakers



Grounding Balls and Covers



Remote Control Pendant



MTK2000 Trip Unit Test Kit

Circuit Breakers

Eaton's Type MDS power circuit breakers constitute a complete, modern and rugged line of low-voltage power circuit breakers using Eaton's DE-ION® principle of arc extinction. The breaker family is distinguished by its similarity of appearance and operation frame to frame. All frame sizes are either manually or electrically operated. Refer to www.eaton.com/CAG for detailed information on Magnum DS low-voltage power circuit breakers.

Breaker Features

Four Physical Frame Sizes

Narrow, standard, double narrow and double to promote breaker application in compact modular enclosures and to improve enclosure density.

Contacts

Magnum DS has silver tungsten moving contacts and silver graphite stationary contacts. The contacts provide a long-wearing, low-resistance joint. The contacts are protected from arcing damage even after repeated interruptions by the "heel-toe" action, which causes the integral arcing contacts to mate before the main contacts part. The arcing contacts then part last, striking the arc away from the main contacts.

The main contacts are of the butt type and are composed of multiple fingers to give many points of contact without alignment being critical.



*Magnum DS Breaker Contacts
(Arc Chutes Removed)*

Stored-Energy Mechanism

A cam-type closing mechanism closes the breaker. It receives its energy from a spring that can be charged by a manual handle on the front of the breaker or by a universal electric motor.

Release of the stored energy is accomplished by manually depressing a button on the front of the breaker or electrically energizing a releasing solenoid.



Magnum DS Low-Voltage Power Circuit Breakers have high withstand ratings from 42 to 100 kA to provide for maximum system coordination and selectivity.

Arc Chute

There are three basic means of extinguishing an arc: lengthening the arc path; cooling by gas blast or contraction; deionizing or physically removing the conduction particles from the arc path.

The DE-ION principle is incorporated in all Magnum DS circuit breakers. This makes possible faster arc extinction for a given contact travel, ensures positive interruption and minimum contact burning.

Levering Mechanism

The worm gear levering mechanism is self-contained on the breaker drawout element and engages slots in the breaker compartment. A standard 3/8-inch (10 mm) drive set is used to lever the breaker between the connected, test and disconnected positions.

Mechanical interlocking is arranged so that levering cannot be accomplished unless the breaker is in the opened position.

Protection During Levering Operation

When levering the breaker between the connected, test and disconnected positions, the operator is protected from contact with live parts by the breaker door.

True two-step stored energy closing:

Refers to the sequence required to charge and close the breaker.

1. The breaker closing springs are charged either through the manual-charging handle or by the optional charging motor. The breaker is mechanically interlocked to prevent closing of the breaker until the closing springs are fully charged.
2. With the closing springs fully charged, the breaker can then be closed by pressing the manual close pushbutton on the breaker, or by the optional spring release coil through a remote electrical signal.

This means that the energy required to open the breaker is always restored following a closing operation.

"Stored energy" is energy held in waiting, ready to open or close the breaker within five cycles or less. The unique cam and spring design provides necessary energy for a single close-open sequence as well as the energy for multiple charge-close operations such as this possible sequence: charge-close-recharge-open-close-open.

The closing springs are interlocked with the breaker racking mechanism to ensure the closing springs are discharged before the breaker can be removed from the compartment.

Provisions for padlocking: All breakers include provision for padlocking open to prevent electrical or manual closing. This padlocking can secure the breaker in the connected, test or disconnected position by preventing levering of the breaker.

Ease of inspection and maintenance: Magnum DS breakers are designed for maximum accessibility and the utmost ease of inspection and maintenance.

Manually operated breakers: Manually operated breakers are equipped with a manual charging handle to charge the closing springs. Manual closing and tripping pushbuttons are used to operate the breaker. Remote closing and tripping can be accomplished by installing optional electric spring release and shunt trip coils. The breaker closing springs must be charged manually, then remote closing and tripping signals can be sent the breaker.

Electrically operated breakers: Electrically operated breakers are equipped with a spring charging motor and electrically operated spring release and shunt trip coils. The breaker manual charging handle can be used to charge the closing springs when power is not available to the charging motor.

Optional Breaker Accessories

- **Shunt trip device (ST):** Provides for remote electrically controlled breaker opening when energized by a rated voltage input
- **Spring charge motor (MOT):** Charges the breaker closing springs automatically, facilitating remote or local closing. The motor assembly includes its own cut-off switch that changes state at the end of the charging cycle. This contact can be wired out for external indication
- **Spring release device (SR):** Provides for remote electrically controlled breaker closing when its coils are energized by a rated voltage input
- **Undervoltage release (UVR):** Trips the breaker when an existing voltage signal is lost or falls below an established threshold
- **Auxiliary switch:** Up to 6a/6b auxiliary individual dedicated contacts are available for customer use to indicate if the breaker is in the OPEN or CLOSE position
- **Mechanical trip indicator flag:** The red trip indicator flag pops out to provide local visual indication when the Digitrip RMS trip unit acts to trip the breaker on an overcurrent condition. Available in two options: an interlocked version that mechanically locks out the breaker until the indicator is manually reset and a non-interlocked version for indication only
- **Bell alarm/overcurrent trip switch (OTS):** Provides two Form C contacts that change state when the Digitrip RMS trip unit acts to trip the breaker. The contacts are available for external indication or customer use and are manually reset by the mechanical trip indicator
- **Padlockable pushbutton cover:** Permits padlocking hinged cover plates to block access to the PUSH ON and PUSH OFF buttons on the breaker faceplate
- **Mechanical operations counter:** Records mechanical operations of the breaker over its installed life
- **Latch check switch:** Provides one Form C contact that changes state when the breaker is ready to close. Can be wired to the spring release device for fast transfer applications or wired for external ready-to-close indication

Magnum DS Switchgear—Trip Units

Digitrip™ RMS trip unit. Eaton's Digitrip RMS trip units feature a dependent curve that is depicted in the nameplate by a blue shaded area of the trip curve. The dependent curve affords better protection flexibility. Additionally, all of the trip units have, as standard, thermal memory, 50/60 Hz operation and thermal self-protection at 90 °C.

Digitrip RMS integral microprocessor-based breaker overcurrent trip systems:

Provide maximum reliability with true rms sensing as standard, gives excellent repeatability and requires minimum maintenance. No external control source is required for its protective functions.



Digitrip 1150+

Trip functions: Magnum DS trip units provide the maximum in flexibility and are available in the following configurations: LSI, LSIG, LSIA (ground fault alarm only). In each case, either the short delay or instantaneous (not both) functions may be defeated. This reduces the need for spare breaker inventories and provides maximum usage of interchangeable breakers.

Digitrip RMS 520: Enables the user as many as nine phase and ground current protection settings for maximum flexibility in trip-curve shaping and multi-unit coordination, and adds zone selective interlocking.

Digitrip RMS 520M: Adds phase, neutral and ground current metering with a four-character LCD display window with 2% current metering accuracy and type LSIA alarm when ground fault settings are exceeded.

Digitrip RMS 520MC: Adds INCOM communication of trip values and breaker status (open, close and tripped). Adds Arcflash Reduction Maintenance System (ARMS).

Digitrip RMS 1150+: Provides programmability for more sophisticated distribution systems. Adds Arcflash Reduction Maintenance System (ARMS).

- Increased protection and coordination capabilities
- Systems monitoring information including power factor, voltage current, harmonic distortion values, and waveform capture with a three-line, (eight characters per line) LED display
- Two programmable contacts for customer use
- Time stamping of trip events for improved troubleshooting and diagnostics
- Accuracy of 1% on metered values and 2% on energy and power
- Systems diagnostic information
- INCOM communications
- Breaker health menu
- Additional protection functions:
 - Undervoltage/overvoltage
 - Underfrequency/overfrequency
 - Voltage unbalance
 - Reverse power

Zone selective interlocking: The Digitrip RMS zone selective interlocking (ZSI) capability provides positive system coordination without time delays. ZSI allows the breaker closest to the fault to trip without any preset time delay. The breaker closest to the fault trips first, while the remainder of the distribution system remains online, thus avoiding unnecessary and costly downtime.

The use of ZSI in Spot Network Systems is not recommended by Eaton. See the discussion in section 18 for the technical reasons why Eaton does not recommend ZSI in Spot Network Systems.

Arcflash Reduction Maintenance System

The Arcflash Reduction Maintenance System Maintenance Mode function of the Digitrip 520MC and 1150+ can reduce arc flash incident energy that is generated on a fault condition. Eaton's Arcflash Reduction Maintenance System employs a separate, dedicated analog trip circuit that eliminates microprocessor latencies, resulting in clearing times that are faster than standard instantaneous tripping. This provides superior arc flash reduction to competing systems that simply lower the standard instantaneous pickup set point.

There are three ways to arm the Maintenance Mode Arc Flash Reduction setting. One method is locally at the trip unit front panel. For the 520MC, the 2-position switch in the Maintenance Mode section of the trip unit is used. Turning the switch to the ON position will arm the setting. For the 1150+, the local front keypad is used to enable the Maintenance Mode setting. The setting is located in the SYSTEM submenu of programmable settings (PGM SET).

For the second method of arming the Maintenance Mode function, a remote switch wired through the breaker secondary contacts can remotely arm the Maintenance Mode setting. A high-quality gold-plated or palladium contact is required in this application.

A third method to arm the maintenance setting is via a communication device. This can be accomplished through a Power Xpert® Gateway.

For Magnum DS breakers, the Arcflash Reduction Maintenance System setting has five unique settings (2.5, 4.0, 6.0, 8.0, $10.0 \times I_n$). To adjust this setting, a rotary switch on the trip unit face is provided for the 520MC while the 1150+ trip unit uses its local keypad. For the Series NRX breakers, the Arcflash Reduction Maintenance System setting has a constant setting of 5000 A.

For all three arming methods, the 520MC provides a blue LED to confirm the Maintenance Mode function is on. In addition, there is also a normally open breaker contact that allows the user to wire in an external stacklight or annunciator for remote indication. For the 1150+, the message "Maintenance Mode Enabled" will be shown on its LED display. The 1150+ also has an alarm relay that can be programmed to track the Maintenance Mode state.





The Maintenance Mode function will provide fast tripping even when the regular Instantaneous is set to OFF. The Instantaneous LED position is also used to indicate a trip initiated by the Maintenance Mode setting. The 520MC LCD display, if powered, will indicate with four dashes while the 1150+ will display the message "Maintenance Mode Trip."



Arcflash Reduction Maintenance System

The Arcflash Reduction Maintenance System can be wired out to a separate lockable switch/light combination mounted on the switchgear for ease of operation. Additionally, the switch can be wired out to a remote station for operation outside the arc flash boundary of the switchgear, and the alarm can be wired to an optional beacon or audible device.

Table 20.2-3. Digitrip Trip Units for Magnum DS and SB ANSI/UL Rated Power Circuit Breakers

Trip Unit Type				
	Digitrip 520	Digitrip 520M	Digitrip 520MC	Digitrip 1150+ ①
Ampere Range	200–6000 A	200–6000 A	200–6000 A	200–6000 A
Interrupting rating at 480 V rms sensing	42–200 kA Yes	42–200 kA Yes	42–200 kA Yes	42–200 kA Yes

Protection and Coordination

Protection	Ordering options fixed rating plug (I_n) overtemperature trip	LI, LSI, LSIG Yes Yes	LSI, LSIG, LSIA Yes Yes	LSI, LSIG, LSIA Yes Yes	LSI, LSIG, LSIA Yes Yes
Long delay protection (L)	Long delay pickup Long delay time I^2t at $6 \times I_r$ Long delay time I^4t IEEE curves	0.4–1.0 x (I_n) 2–24 seconds No No	0.4–1.0 x (I_n) 2–24 seconds No No	0.4–1.0 x (I_n) 2–24 seconds No No	0.4–1.0 x (I_n) 2–24 seconds 1–5 seconds Yes
	Long Delay Thermal Memory High Load Alarm	Yes No	Yes No	Yes No	Yes 0.5–1.0 x (I_r)
Short delay protection (S)	Short delay pickup Short delay time I^2t at $8 \times I_r$ Short delay time flat Short delay time ZSI	200–1000% x (I_r) & M1 100–500 ms 100–500 ms Yes	200–1000% x (I_r) & M1 100–500 ms 100–500 ms Yes	200–1000% x (I_r) & M1 100–500 ms 100–500 ms Yes	200–1000% x (I_r) & M1 100–500 ms 100–500 ms Yes
Instantaneous protection (I)	Instantaneous pickup making current release off position	200–1000% x (I_n) & M1 Yes LSI & LSIG	200–1000% x (I_n) & M1 Yes Yes	200–1000% x (I_n) & M1 Yes Yes	200–1000% x (I_n) & M1 Yes Yes
Ground fault protection (G) ②	Ground fault alarm Ground fault pickup Ground fault delay I^2t at $0.625 \times I_n$	No 25–100% x (I_n) 100–500 ms	Yes 25–100% x (I_n) 100–500 ms	Yes 25–100% x (I_n) 100–500 ms	Yes 24–100% x (I_n) 100–500 ms
	Ground fault delay flat Ground fault ZSI Ground fault thermal memory	100–500 ms Yes Yes	100–500 ms Yes Yes	100–500 ms Yes Yes	100–500 ms Yes Yes
Disable ground fault protection	No	No	No	No	No
Neutral protection (N)	Model LSI	Model LSI	Model LSI	Model LSI	Model LSI

System Diagnostics

Cause of trip LEDs	Yes	Yes	Yes	Yes
Magnitude of trip information	No	Yes	Yes	Yes
Remote signal contacts	No	Yes	Yes	Yes
Programmable contacts	No	No	No	Yes

System Monitoring

Digital display	No	4-character LCD	4-character LCD	24-character LED
Current (%) full scale sensor	No	Yes $\pm 2\%$	Yes $\pm 2\%$	Yes $\pm 1\%$
Voltage (%) L to L	No	No	No	Yes $\pm 1\%$
Power and energy (%)	No	No	No	Yes $\pm 2\%$
Apparent power kVA and demand	No	No	No	Yes
Reactive power kvar	No	No	No	Yes
Power factor	No	No	No	Yes
Crest factor	No	No	No	Yes
Power quality—harmonics	No	No	No	Yes
%THD, waveform capture	No	No	No	Yes

System Communications

Type	No	No	INCOM	INCOM/TripLink
Power supply in breaker	N/A	Optional	Standard	Standard

Additional Features

Trip log (three events)	No	No	No	Yes
Electronic operations counter	No	No	No	Yes
Testing method ③	Test set	Test set	Test set	Integral and test set
Waveform capture	No	No	No	Yes
Arcflash Reduction Maintenance System	No	No	Yes	Yes
Breaker health monitor	No	No	No	Yes
Programmable relay functions	No	No	No	Yes ①

① Over and undervoltage alarm or trip, over and underfrequency alarm or trip, voltage unbalance alarm or trip, reverse power trip and phase rotation alarm are included.

② 1200 A maximum ground fault setting per UL/NEC®.

③ Test set for secondary injection.

Legend: I_n = Rating Plug and Sensor Rating.
 I_r = Long Delay Pickup setting.

Table 20.2-4. Magnum DS Breakers Digitrip Adjustable Trip Settings

Time/Current Characteristic	Pickup Setting	Pickup Point ①	Time Bands, Seconds
Long delay	0.4, 0.5, 0.6, 0.7, 0.8, 0.9, 0.95, 1.0	I_n times long delay setting	2, 4, 7, 10, 12, 15, 20, 24
Instantaneous	Off, 2, 3, 4, 6, 8, 10, M1	I_n times instantaneous setting	—
Short delay	2, 2.5, 3, 4, 6, 8, 10, M1	I_r times short delay setting	0.1, 0.2, 0.3, 0.4, 0.5 flat response 0.1, 0.03, 0.05 ②
Ground fault	0.25, 0.3, 0.35, 0.4, 0.5, 0.6, 0.75, 1.0	I_n times ground fault setting	0.1, 0.2, 0.3, 0.4, 0.5 (flat response) 0.1, 0.3, 0.5 ②

- ① I_n = Rating plug value
 I_r = Long delay pickup setting x I_n
 ② I^2t response

Table 20.2-5. Magnum DS Switchgear Class UL 1066 Low-Voltage Power Circuit Breakers

Frame Amperes	Breaker Type	Frame Type	rms Symmetrical Current Ratings kA 50/60 Hz ①			Short-Time Withstand Rating	Fixed Internal Instantaneous Trip	Available Current Sensor and Rating Plugs for Digitrip RMS Trip Unit (Establishes Breaker I_n Rating)
			Interrupting at 254 Vac	Interrupting at 508 Vac	Interrupting at 635 Vac			
800	MDN-408	Narrow	42	42	42	42	—	200, 250, 300, 400, 600, 800
	MDN-608	Narrow	65	65	65	65	—	
	MDN-C08	Narrow	100	100	65	20	18 x I_n	
	MDS-408	Standard	42	42	42	42	—	
	MDS-608	Standard	65	65	65	65	—	
	MDS-808	Standard	85	85	85	85	—	
1600	MDN-416	Narrow	42	42	42	42	—	200, 250, 300, 400, 600, 800, 1000, 1200, 1600
	MDN-616	Narrow	65	65	65	65	—	
	MDN-C16	Narrow	100	100	65	30	18 x I_n	
	MDS-616	Standard	65	65	65	65	—	
	MDS-816	Standard	85	85	85	85	—	
	MDS-C16	Standard	100	100	100	85	85	
2000	MDN-620	Narrow	65	65	65	65	—	200, 250, 300, 400, 600, 800, 1000, 1200, 1600, 2000
	MDS-620	Standard	65	65	65	65	—	
	MDS-820	Standard	85	85	85	85	—	
	MDS-C20	Standard	100	100	100	85	85	
3200	MDS-632	Standard	65	65	65	65	—	200, 250, 300, 400, 600, 800, 1000, 1200, 1600, 2000, 2500, 3000, 3200
	MDS-832	Standard	85	85	85	85	—	
	MDS-C32	Standard	100	100	100	85	85	
4000	MDN-640	Double Narrow	65	65	65	65	—	2000, 2500, 3200, 4000
	MDN-840	Double Narrow	85	85	65	85	—	
	MDN-C40	Double Narrow	100	100	65	100	—	
	MDS-840	Double	85	85	85	85	—	
5000	MDS-850	Double	85	85	85	85	—	2500, 3200, 4000, 5000
	MDS-C50	Double	100	100	100	100	—	
6000	MDS-C60 ②	Double	100	100	100	100	—	3200, 4000, 5000, 6000

- ① Interrupting ratings shown based on breaker equipped with integral Digitrip RMS trip unit. Interruption ratings for non-automatic breakers are equal to the published short-time withstand rating. These interruption ratings are based on the standard duty cycle consisting of an open operation, a 15-second interval and a close-open operation, in succession, with delayed tripping in case of short-delay devices. The standard duty cycle for short-time ratings consists of maintaining the rated current for two periods of 1/2 second each, with a 15-second interval of zero current between the two periods.
 ② Breaker applied in a tested fan cooled enclosure.

Meters

Power Xpert Meter 4000/6000/8000 Series



Power Xpert Meter Display

General Description

The Power Xpert Meter 4000/6000/8000 Series monitors the critical aspects of an electrical distribution system. This premier power quality metering instrument is simple to use, and is powerful, scalable and highly flexible. The Power Xpert Meter 4000/6000/8000 offers a new level of intuitive user interface design, presenting critical electrical distribution system information in simple-to-navigate and easy-to-understand information architecture.

The Power Xpert Meter 4000/6000/8000 graphic display visualizes the information from up to 16 meter modules. The embedded Web server displays complex power quality data using standard Internet browsers and allows for device configuration from the browser.

Both the local graphic display and the embedded Web server present real time, historical and event information in a browser-style graphical format to help the user interpret key circuit information, such as:

- Current loading
- Voltage and power levels
- Power factor
- Energy usage
- I/O status
- Power quality measurements
- Harmonic plots
- Disturbance and transient waveforms
- ITIC disturbance summary screen

The Web server provides the energy and demand readings required to help manage the cost of energy. It also provides critical information regarding power quality, such as harmonic distortion, flicker, crest factor, K-Factor and more.

Power Xpert Meter 2000



Power Xpert Meter 2000

General Description

The Power Xpert 2000 Series Meter power quality instrument monitors the most critical aspects of an electrical distribution system. This premier power quality metering instrument uses the latest in advanced technology to make it simple to use, and is powerful, scalable and highly flexible. The Power Xpert 2000 displays critical electrical distribution system information in a simple-to-navigate and easy-to-understand information architecture.

The embedded Web server displays comprehensive power quality data using standard Internet browsers and allows for device configuration from the browser. The embedded Web server presents real-time, historical and event information in a browser-style graphical format to help the user interpret information such as current loading, voltage and power levels, power factor, energy usage, I/O status and power quality measurements, as well as harmonic plots. The embedded Web server also offers a waveform view to visualize steady-state harmonic content, which is critical for power quality analysis.

The Web server provides the energy and demand readings required to help manage the cost of energy.

Application Description

Identify Power Quality Problems to Help:

- Protect motors from damage
- Preserve the integrity of processes and batches
- Prevent blown capacitor bank fuses
- Protect transformers and conductors from overheating

Monitor Circuit Loading to Help:

- Avoid overloads and nuisance overload trips
- Maximize equipment use
- Manage emergency overloads

Manage Energy Use to Help:

- Reduce peak demand charges and power factor penalties
- Identify excessive energy consumption

IQ 250/260



IQ 250/260

General Description

This microprocessor device provides metering that meets ANSI C12.20 revenue metering accuracy, and has capabilities such as fast sampling rate and accurate metering for a full range of power attributes. In addition, the IQ 250 and IQ 260 Meters are "prepared for the future." Built-in slots allow for upgrades to capabilities yet to be developed.

- Comprehensive metering
- High-end accuracy
- Self-test capability to validate accuracy
- Large, easy-to-read display
- Local or remote configuration
- Industry-standard communication protocols
- Mix-and-match input/output options
- Integration with Eaton's Power Xpert Architecture
- Field-upgradeable

Communications

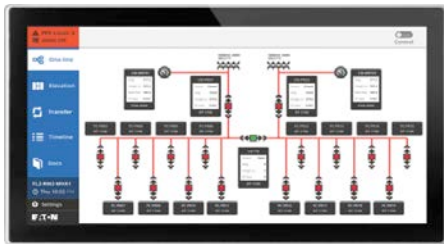

Dashboard



PXG900

Ethernet communications available via Power Xpert Gateway PXG900.

- Power Xpert Gateway 900
 - ModbusTCP connection to Digitrip 520MC and 1150 trip units.
 - Basic web browser view
 - Optional 12" display
- Power Xpert Dashboard
 - The Power Xpert Dashboard is an intelligent collection of views displayed on a single touchscreen from switchgear-mounted devices including meters, relays, trip units and transfer controls
 - The Dashboard can be integral to the switchgear assembly or remotely mounted
 - Detail information about each breaker is displayed
 - Remote enabling of the Arcflash Reduction Maintenance System via communication as a standard
 - Ability to configure/monitor alarms for various devices
 - Remotely open/close circuit breakers through control mode
 - Initiate a transfer scheme in a main-tie-main switchgear for uninterrupted power supply

Automatic Transfer



Programmable Logic Controller



ATC-900

Automatic transfer and intelligent control packages are as follows:

- Eaton ATC-900 controller
 - Automatic transfer for a two source lineup with no tie breaker
 - Additional option for a 7-inch screen available
- Eaton programmable logic controller (PLC) with Eaton touch screen
 - Automatic transfer for main-tie-main arrangement
 - Standard sequence provided with configurable options
 - Custom sequence of operations available
- Eaton Power Systems Control (offered through Eaton's Engineering Services & Systems)
 - Custom automatic transfers
 - On-site commissioning
 - Integration into existing networks

High Resistance Grounding

General Description

Where continuity of service is a high priority, high-resistance grounding can add the safety of a grounded system while minimizing the risk of service interruptions due to grounds. The concept is a simple one: provide a path for ground current via a resistance that limits the current magnitude, and monitor to determine when an abnormal condition exists. This provides for maximum continuity of service, because no tripping occurs for the resistance limited ground fault.

The ground current path is provided at the point where the service begins, by placing resistance in the connection from system neutral to ground. Control equipment continuously measures ground current; a relay detects when the current exceeds a predetermined level. An alarm alerts building personnel that a ground exists. The system has built-in fault tracing means to assist in finding the source of the ground. An integral transformer provides control power from the primary source.



Integrated HRG

Standard Features

- Current sensing ground fault detection (1–5 A pickup/0.5–20 second delay)
- Ground current transformer (10/10 ratio)
- Control circuit disconnect switch (fused)
- Lockable door handle
- Ground current ammeter (0–10 A, 1% accuracy)
- Indicating lights:
 - Red (ground fault)
 - Green (normal)
 - White (pulse)
- Adjustable pulsing timer (0–10 seconds)
- Tapped resistors (1–5 A)
- Three-position selector switch (normal, pulse, test)
- Control switch for manual or automatic reset
- Ground fault contacts (1NO/1NC)
- Shorting terminal block for ground current transformer
- UL label
- Rated for use up to 200 kA fault current system
- Front accessible
- Nylon flag type wiremarkers
- Three “zig-zag” or “wye-broken delta” grounding transformers for systems without a neutral point

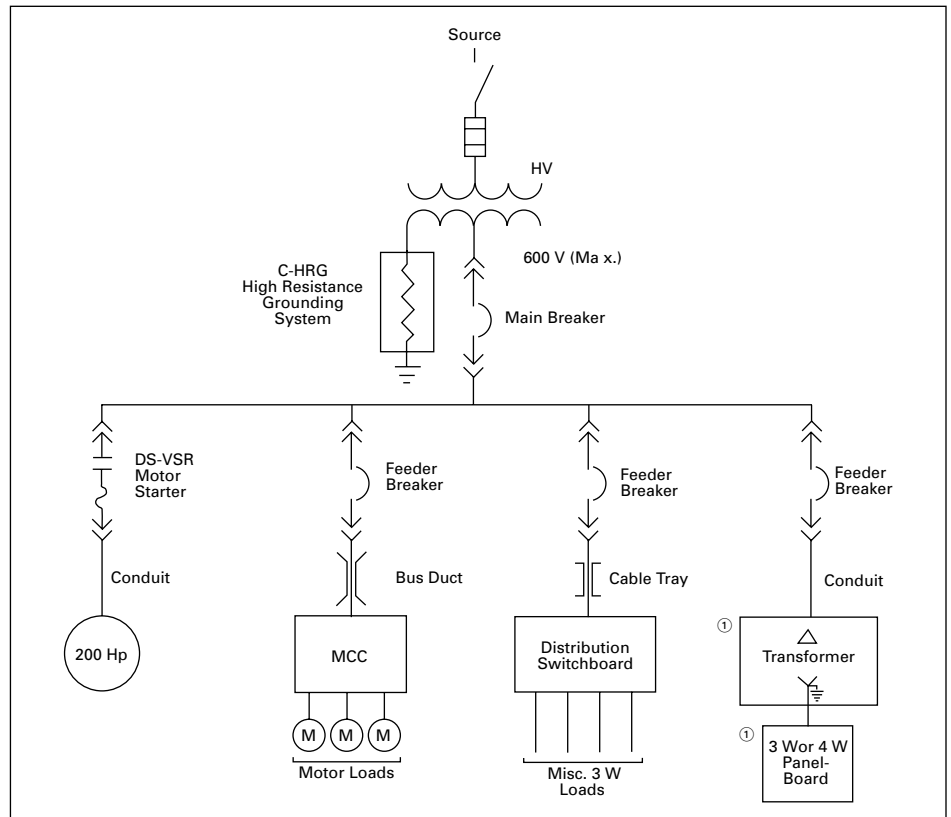

Figure 20.2-1. Typical Distribution System

① Phase-to-neutral loads require a delta-ye distribution transformer. The neutral on the secondary side of this transformer must be solidly grounded.

Breaker Layouts

Magnum DS Rear-Accessible Switchgear

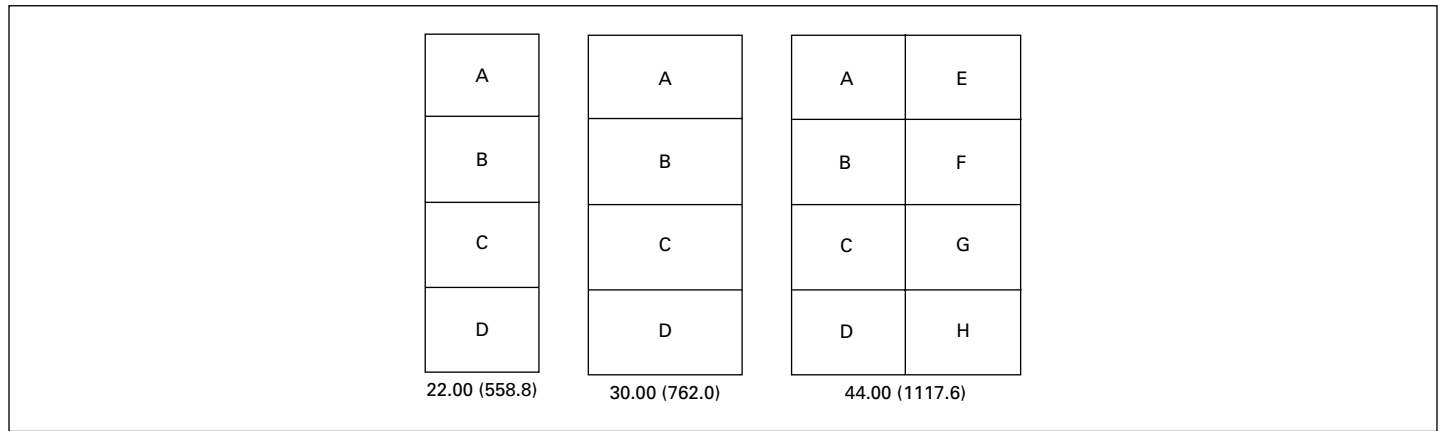

Figure 20.2-2. Breaker Structures—Dimensions in Inches (mm)

A	Metering	Feeder MDS-608 800 A		Feeder MDS-608 800 A	Metering	A/E	Metering	SPD	Feeder MDS-608 800 A	Feeder MDS-608 800 A	Metering	SPD	
	Main MDS-632 3200 A	Feeder MDS-608 800 A	Tie MDS-630 3200 A	Feeder MDS-608 800 A	Main MDS-632 3200 A		B/F	Main MDS-840 4000 A		Tie MDS-840 4000 A		Main MDS-840 4000 A	
	SPD	Feeder MDS-608 800 A	Feeder MDS-608 800 A	Feeder MDS-608 800 A	SPD		C/G	Feeder MDS-608 800 A	Feeder MDS-608 800 A	Feeder MDS-608 800 A	Feeder MDS-608 800 A	Feeder MDS-608 800 A	Feeder MDS-608 800 A
		Feeder MDS-608 800 A	Feeder MDS-608 800 A	Feeder MDS-608 800 A			D/H	Feeder MDS-616 1600 A	Feeder MDS-616 1600 A	Feeder MDS-616 1600 A	Feeder MDS-616 1600 A	Feeder MDS-616 1600 A	Feeder MDS-616 1600 A
	22.00 (558.8)	22.00 (558.8)	22.00 (558.8)	22.00 (558.8)	22.00 (558.8)		44.00 (1117.6)		44.00 (1117.6)		44.00 (1117.6)		
Using Standard Breakers						Using Standard and Double Breakers							

Figure 20.2-3. Main-Tie-Main Typical Layouts—Dimensions in Inches (mm)

Note: Breaker and cell utilization should keep load amperes below rating of MAIN due to vertical bus limitations. Cable used in the conduit areas are limited to 75 °C ampacity values per the NEC for ampacity calculations. Any cell not used as a feeder breaker may be a blank, or a feeder breaker provision for future breakers, or SPD surge. Section bus sized per main bus rating (maximum) or by ANSI C37.20.1.

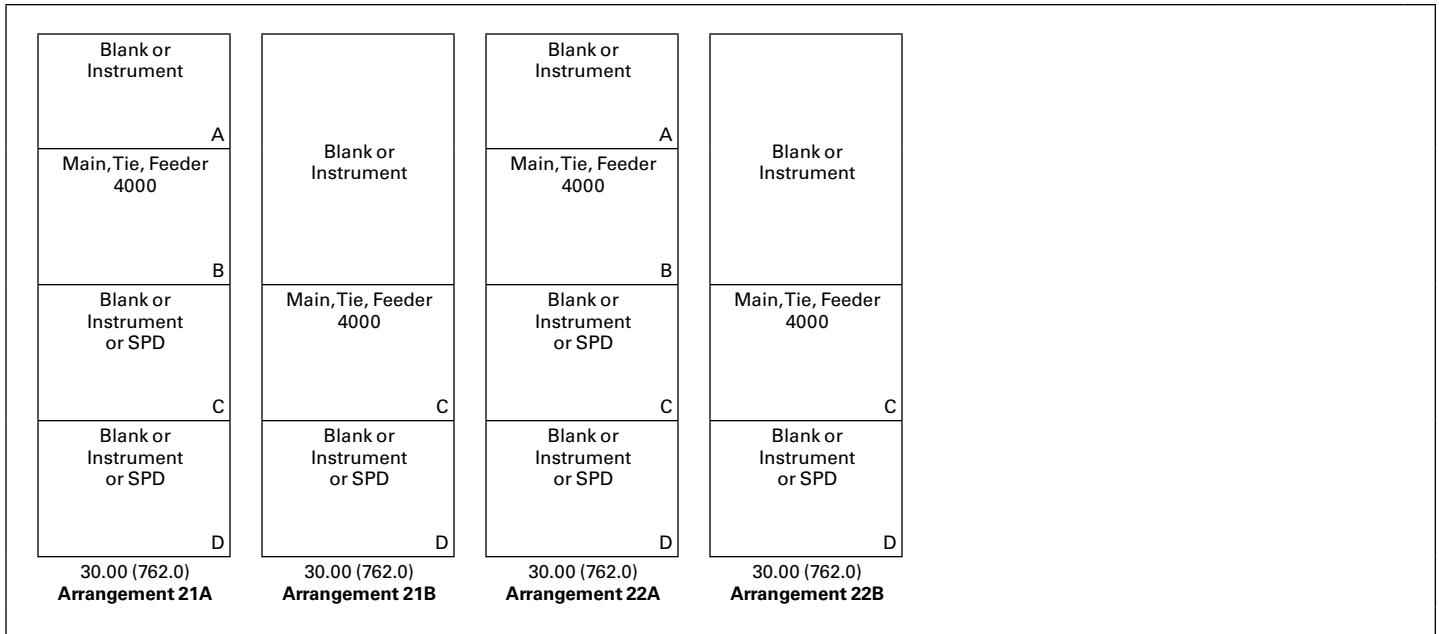

Figure 20.2-4. Typical Structure and Breaker Arrangements—4000 A, MDN Mains, Ties, Feeders and Miscellaneous—Dimensions in Inches (mm)
Note: Minimum structure depth is 72 inches.

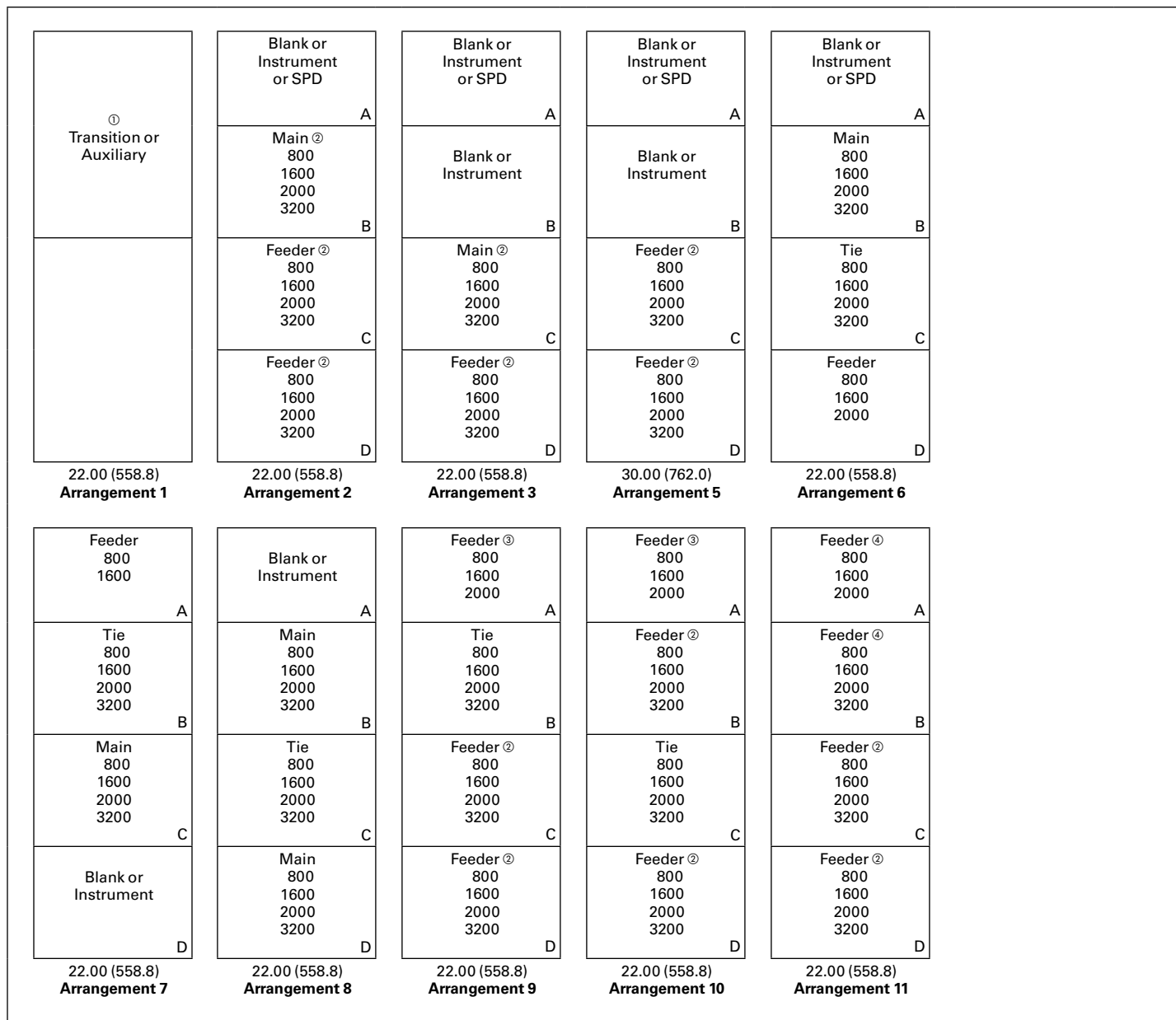

Figure 20.2-5. Typical Structure and Breaker Arrangements—Magnum DS Mains, Ties, Feeders and Miscellaneous, 3200 A and Below ⑤

- ① A transition section is required when close-coupling to an Eaton sourced liquid filled transformer. A transition section is required when close coupling to non-Eaton sourced transformers. A transition section is required when close coupling to other distribution equipment.
 - ② A maximum of two 3200 A breakers are permitted per 22.00-inch (558.8 mm) width of switchgear, one of which must be a main or tie. For a 3200 A frame breaker mounted in the same enclosure with a 4000 A or 5000 A main or tie, contact Eaton.
 - ③ Contact Eaton for placement of 2000 A frame breaker in this compartment.
 - ④ A maximum of three 2000 A breakers are 22.00-inch (558.8 mm) width of switchgear. If three are required, positions B, C and D must be used.
 - ⑤ Any 22.00-inch (558.8 mm) wide compartment can be a blank or instrument compartment.
- Note:** Breaker and cell utilization should keep load amperes below rating of MAIN due to vertical bus limitations. Cable used in the conduit areas are limited to 75 °C ampacity values per the NEC for ampacity calculations. Any cell not used as a feeder breaker may be a blank, or a feeder breaker provision for future breakers, or SPD surge. Section bus sized per main bus rating (maximum) or by ANSI C37.20.1.

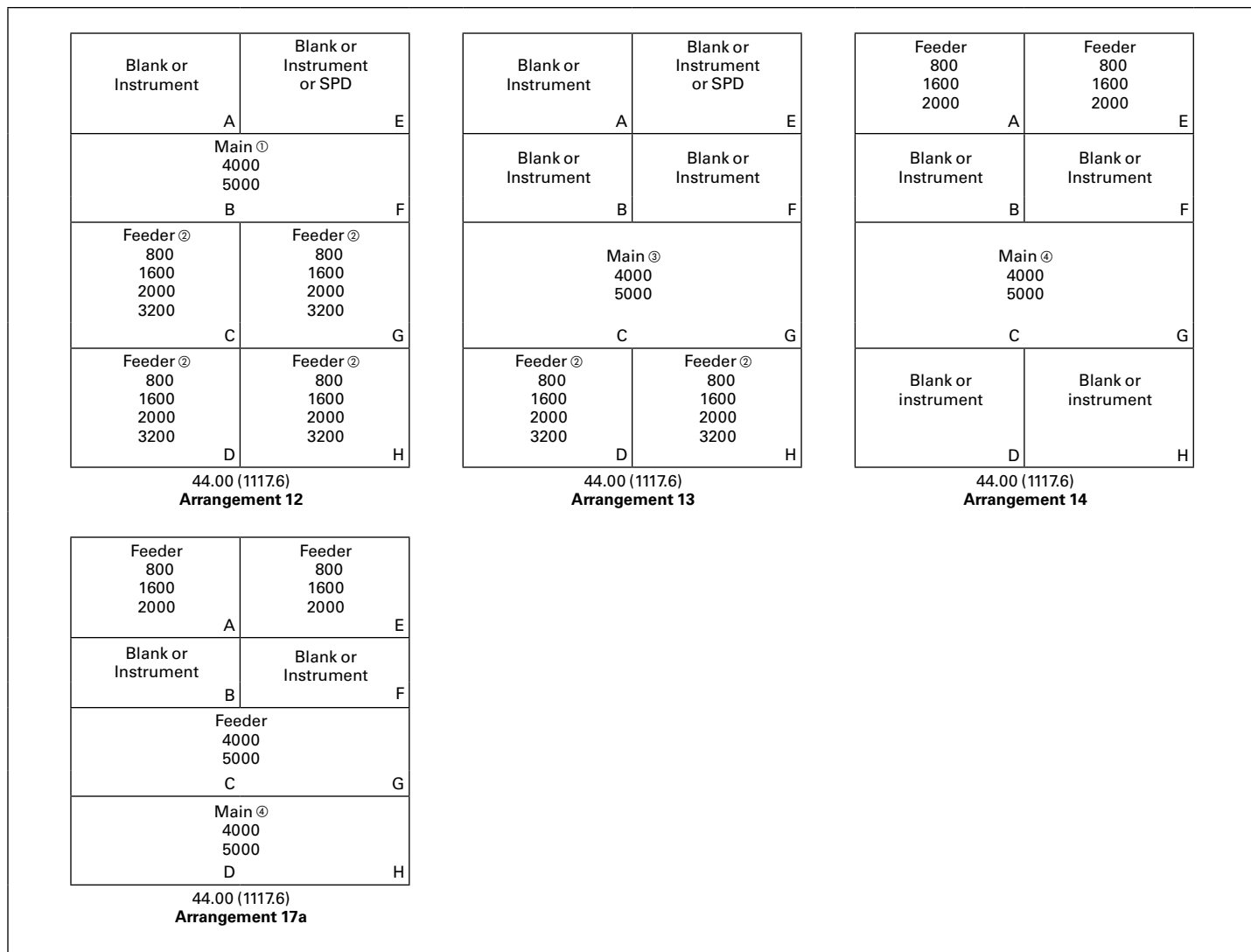

Figure 20.2-5. Typical Structure and Breaker Arrangements (Continued)—Magnum DS Mains, 4000 A and 5000 A

- ① If you have four-wire service and service entrance requirement, busway connection or cable connection, the bus or cables must enter from the top.
- ② A maximum of two 3200 A breakers are permitted per 22.00-inch (558.8 mm) width of switchgear, one of which must be a main or tie. For a 3200 A frame breaker mounted in the same enclosure with a 4000 A or 5000 A main or tie, contact Eaton.
- ③ Service entrance option is not available with feeder breakers mounted in this structure.
- ④ If you have four-wire service and service entrance requirement, busway connection or cable connection, the bus or cables must enter from the bottom.
- ⑤ Any 22.00-inch (558.8 mm) wide compartment can be a blank or instrument compartment with the following exception: A 44.00-inch (1117.6 mm) wide instrument compartment must be adjacent to another 44.00-inch (1117.6 mm) wide compartment in the structure.

Note: Breaker and cell utilization should keep load amperes below rating of MAIN due to vertical bus limitations. Cable used in the conduit areas are limited to 75 °C ampacity values per the NEC for ampacity calculations. Any cell not used as a feeder breaker may be a blank, or a feeder breaker provision for future breakers, or SPD surge. Section bus sized per main bus rating (maximum) or by ANSI C37.20.1.

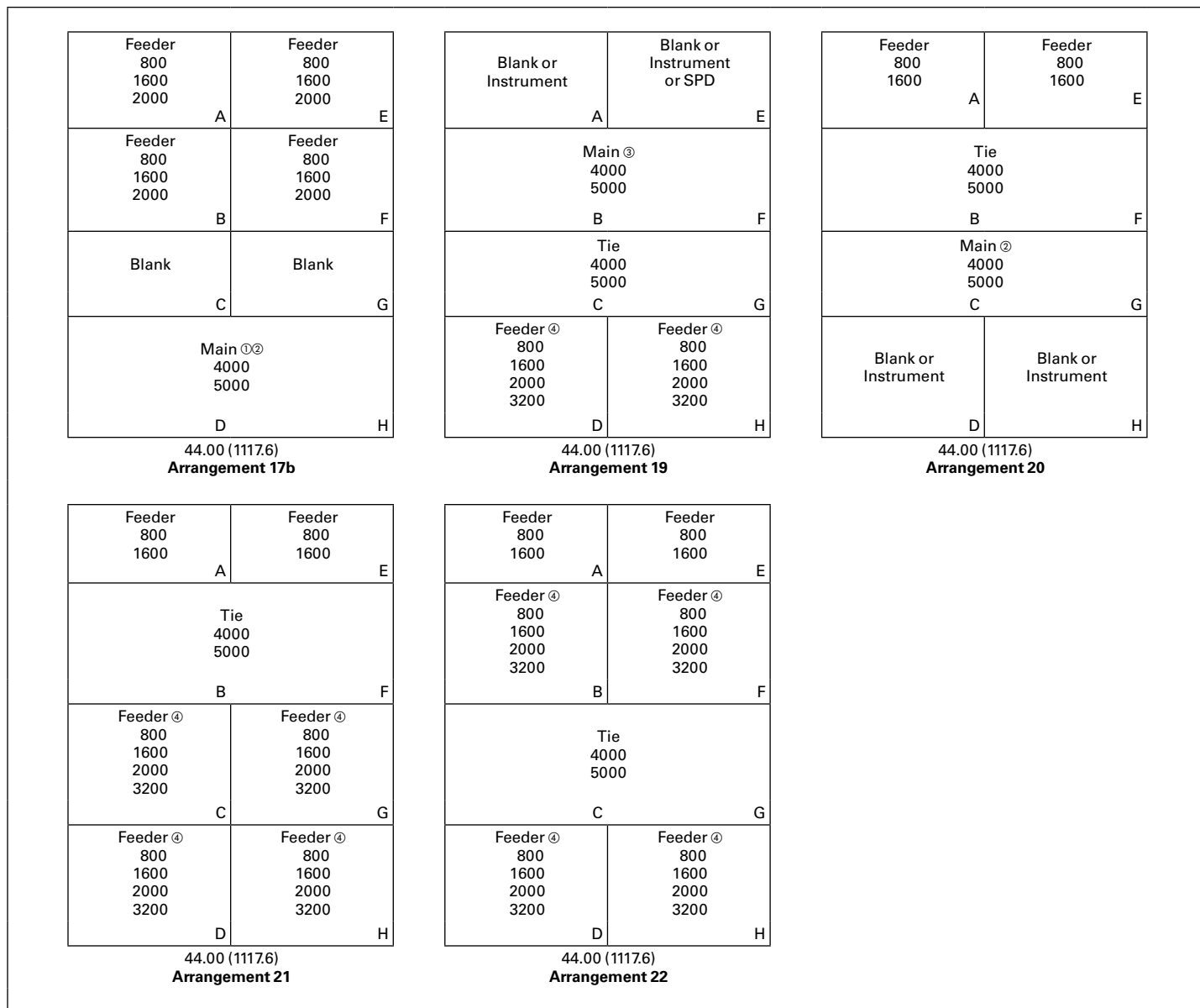

Figure 20.2-5. Typical Structure and Breaker Arrangements (Continued)—Magnum DS Mains and Ties, 4000 A and 5000 A ⑤

- ① Fixed-mounted main breakers are not permitted in the “D” position.
- ② If you have four-wire service and service entrance requirement, busway connection or cable connection, the bus or cables must enter from the bottom.
- ③ If you have four-wire service and service entrance requirement, busway connection or cable connection, the bus or cables must enter from the top.
- ④ A maximum of two 3200 A breakers are permitted per 22.00-inch (558.8 mm) width of switchgear, one of which must be a main or tie. For a 3200 A frame breaker mounted in the same enclosure with a 4000 A or 5000 A main or tie, contact Eaton.
- ⑤ Any 22.00-inch (558.8 mm) wide compartment can be a blank or instrument compartment with the following exception: A 44.00-inch (1117.6) wide instrument compartment must be adjacent to another 44.00-inch (1117.6 mm) wide compartment in the structure.

Note: Breaker and cell utilization should keep load amperes below rating of MAIN due to vertical bus limitations. Cable used in the conduit areas are limited to 75 °C ampacity values per the NEC for ampacity calculations. Any cell not used as a feeder breaker may be a blank, or a feeder breaker provision for future breakers, or SPD surge. Section bus sized per main bus rating (maximum) or by ANSI C37.20.1.

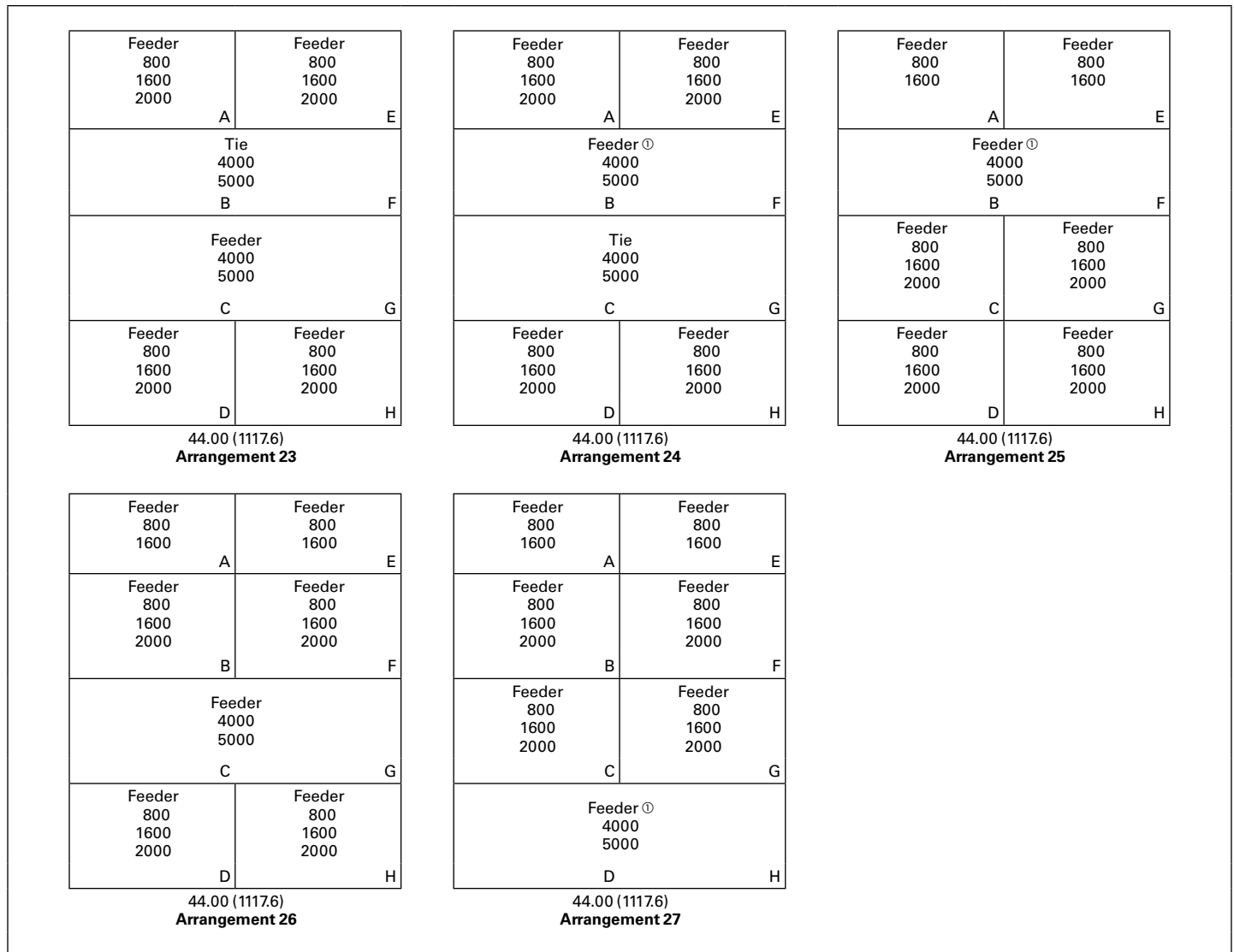
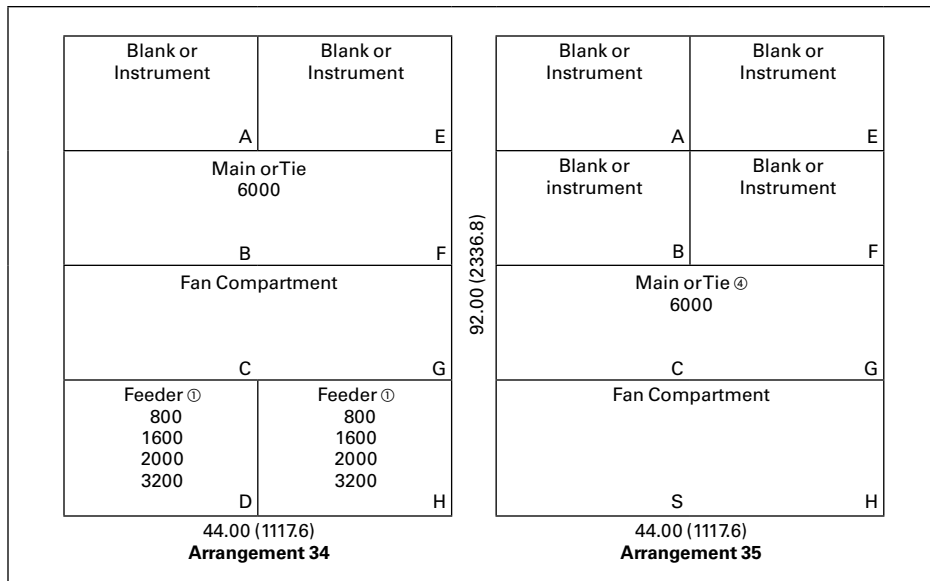

Figure 20.2-5. Typical Structure and Breaker Arrangements (Continued)—Magnum DS Ties and Feeders, 4000 A and 5000 A ②

① "B" and "D" position feeders must be reverse fed.

② Any 22.00-inch (558.8 mm) wide compartment can be a blank or instrument compartment with the following exception: A 44.00-inch (1117.6) wide instrument compartment must be adjacent to another 44.00-inch (1117.6) wide compartment in the structure.

Note: Breaker and cell utilization should keep load amperes below rating of MAIN due to vertical bus limitations. Cable used in the conduit areas are limited to 75 °C ampacity values per the NEC for ampacity calculations. Any cell not used as a feeder breaker may be a blank, or a feeder breaker provision for future breakers, or SPD surge. Section bus sized per main bus rating (maximum) or by ANSI C37.20.1.



**Figure 20.2-5. Typical Structure and Breaker Arrangements (Continued)—
 Magnum DS Mains and Ties, 6000 A ③**

- ① A maximum of two 3200 A breakers are permitted per 22.00-inch (559 mm) width of switchgear, one of which must be a main or tie. For a 3200 A frame breaker mounted in the same enclosure with a 4000 A, 5000 A or 6000 A main or tie, contact Eaton.
- ② When a top-of-gear breaker lifter is used, height is 99.00 inches (2514.6 mm) total.
- ③ Any 22.00-inch (558.8 mm) wide compartment can be a blank or instrument compartment with the following exception: 44.00-inch (1117.6) wide instrument compartment must be adjacent to another 44.00-inch (1117.6) wide compartment in the structure.
- ④ May need a 44.00-inch wide section on both sides of the tie for layout to be correct.

Note: Breaker and cell utilization should keep load amperes below rating of MAIN due to vertical bus limitations. Cable used in the conduit areas are limited to 75 °C ampacity values per the NEC for ampacity calculations. Any cell not used as a feeder breaker may be a blank, or a feeder breaker provision for future breakers, or SPD surge. Section bus sized per main bus rating (maximum) or by ANSI C37.20.1.

Structure Dimensions

Conduit Area Location

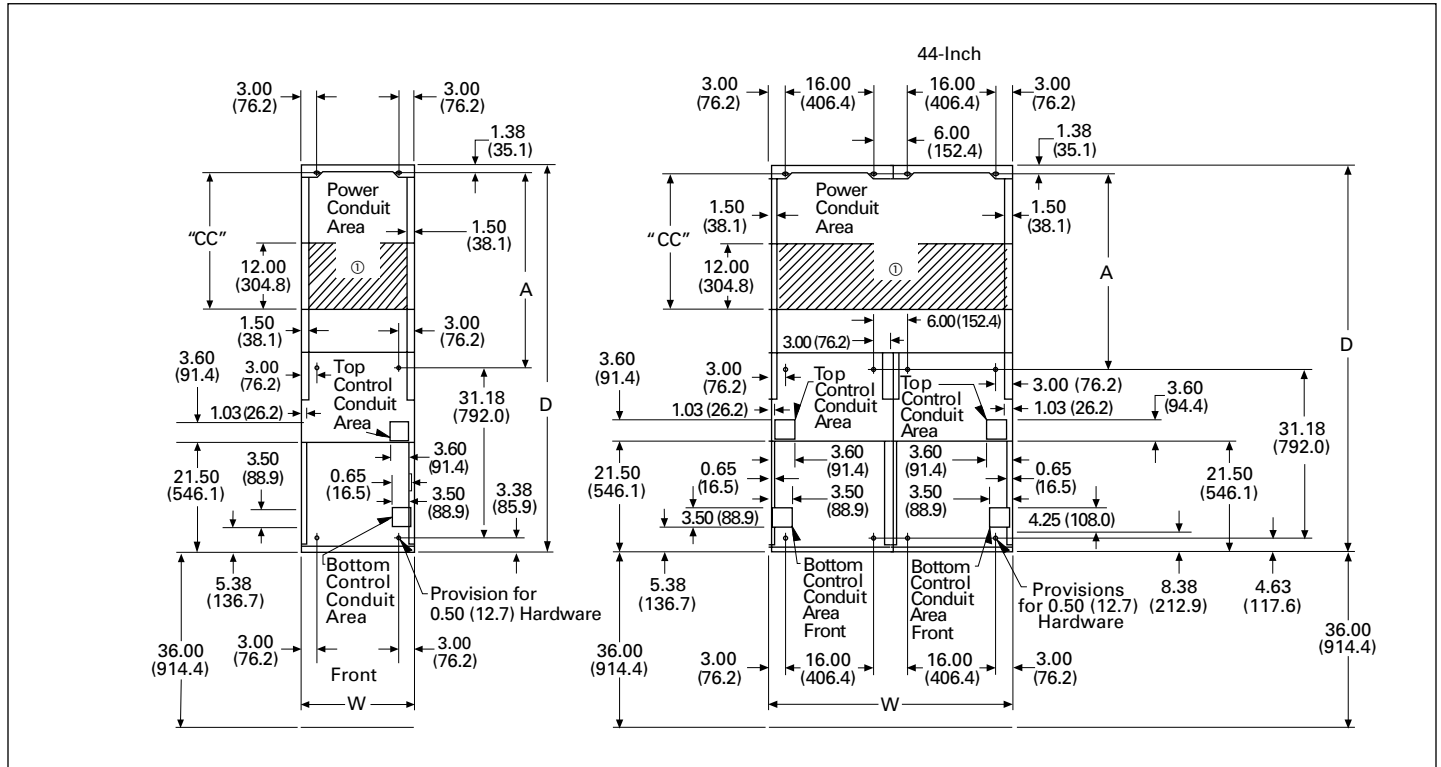

Figure 20.2-6. Floor Plans and Available Conduit Space—18.00, 22.00, 30.00, 44.00-Inch (457.2, 558.8, 762.0, 1117.6 mm) Wide Rear-Access Structures—Dimensions in Inches (mm)

① This dimension is reduced by 12.00 inches (304.8 mm) when vertical section is close coupled to a dry-type transformer due to secondary bus connections.

Note: See **Table 20.2-6** for further information on cable and conduit recommendations.

Table 20.2-6. Arc-Resistant Structure Dimensions in Inches (mm)

W	D	A	CC	Recommended Number of Conduits for Top Entry ①
				4.00 Inch (101.6 mm)
22.00 (558.8)	72.00 (1828.8)	36.00 (914.4)	14.80 (375.9)	6
	78.00 (1981.2)	42.00 (1066.8)	20.80 (528.3)	9
	84.00 (2133.6)	48.00 (1219.2)	26.80 (680.7)	13
	90.00 (2286.0)	54.00 (1371.6)	34.80 (883.9)	15
30.00 (762.0)	72.00 (1828.8)	36.00 (914.4)	14.80 (375.9)	8
	78.00 (1981.2)	42.00 (1066.8)	20.80 (528.3)	12
	84.00 (2133.6)	48.00 (1219.2)	26.80 (680.7)	20
	90.00 (2286.0)	54.00 (1371.6)	34.80 (883.9)	24
44.00 (1117.6)	72.00 (1828.8)	36.00 (914.4)	14.80 (375.9)	12
	78.00 (1981.2)	42.00 (1066.8)	20.80 (528.3)	18
	84.00 (2133.6)	48.00 (1219.2)	26.80 (680.7)	26
	90.00 (2286.0)	54.00 (1371.6)	34.80 (883.9)	30

① Arc-resistant switchgear's conduit space for bottom entry is the same as regular rear-accessible gear.

Section View

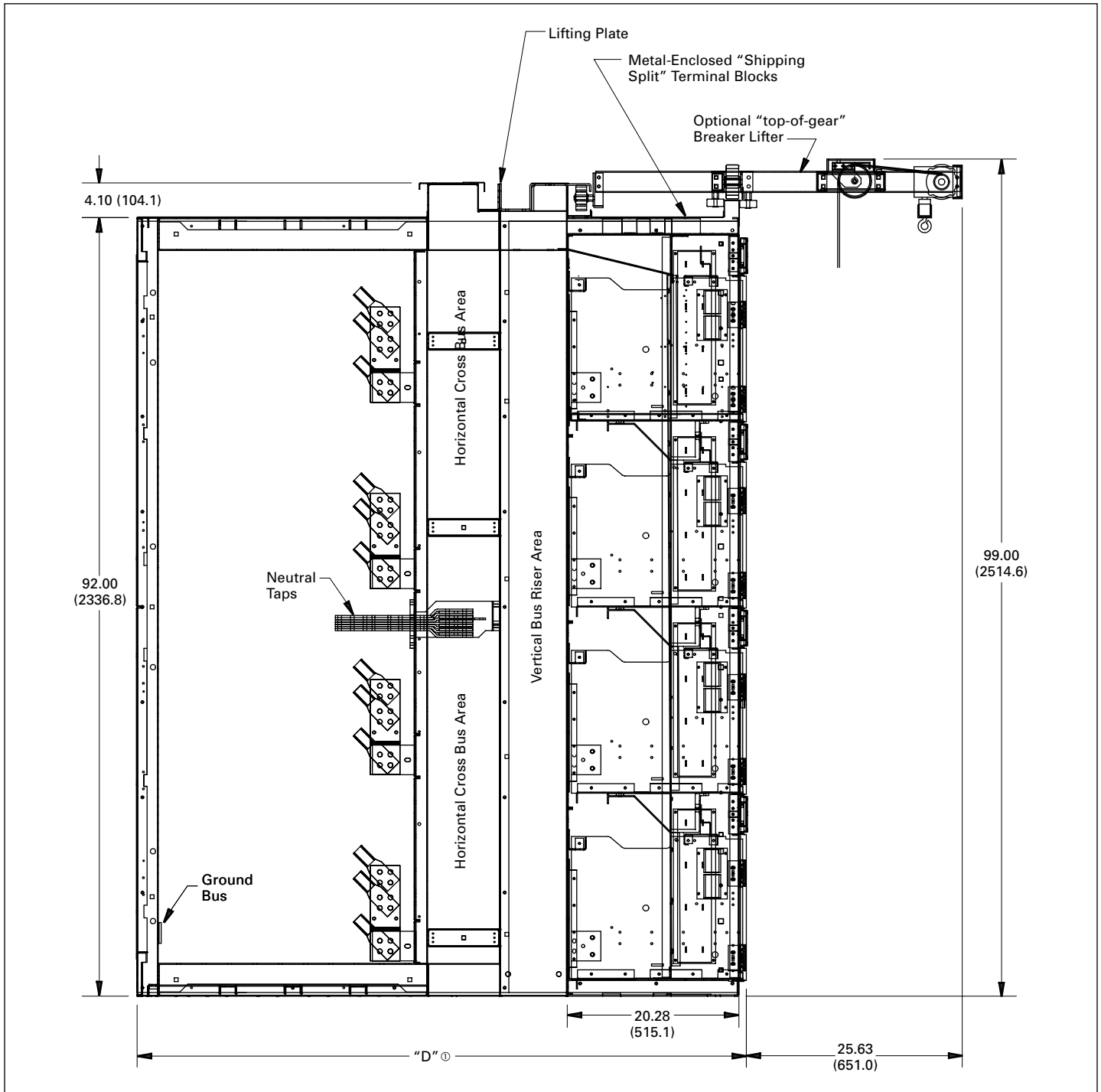

Figure 20.2-7. Section View of a Typical Structure with Magnum DS Breakers

① See Table 20.2-6 on Page 20.2-23 for depth information and recommended number of cables.

Arc-Resistant Switchgear

All layouts are available with the following considerations:

1. Utility compartments are not arc resistant.
2. Only allowed structure widths are 22.00-inch (558.8 mm), 30.00-inch (762.0) and 44.00-inch (1117.6).
3. Group-mounted molded case circuit breaker switchboard sections are not arc resistant.
4. Only MDS and MDN breakers are allowed.
5. For 100 kAIC rating, system voltage must be 480 V or less and utilize 30-inch and 44-inch wide structures only.

The following minimum dimensional requirements also apply:

Table 20.2-7. Minimum Dimensional Requirements

Dimension	Minimum in Inches (mm)
Overall width required	
100 kAIC	60.00 (1524.0)
85 kAIC	60.00 (1524.0)
65 kAIC	44.00 (1117.6)
Depth (rear access)	72.00 (1828.8)
Height (without plenum)	96.10 (2440.9) See Figure 20.2-9
Height (with plenum)	117.00 (2971.8) See Figure 20.2-10

Outdoor/sprinkler proof enclosures are not currently available in arc-resistant gear.

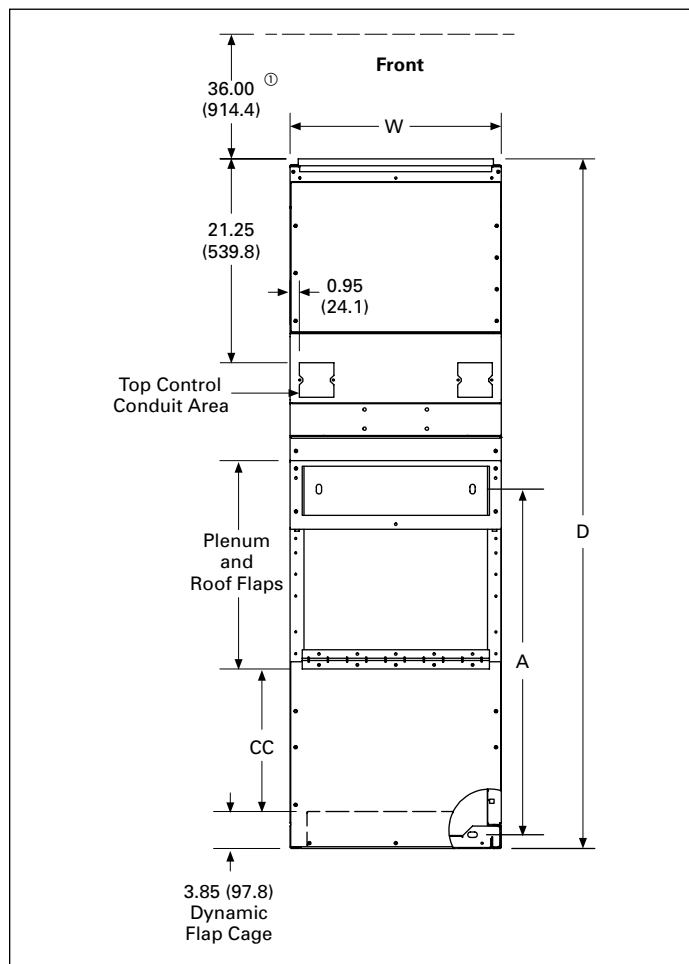

Figure 20.2-8. Arc-Resistant Structure Floor Plans and Available Conduit Space—Dimensions in Inches (mm)

① 36.00 inches (914.4 mm) is the recommended front clearance for breaker removal with top-of-switchgear-mounted breaker lifter. If a portable breaker lifter is to be used, allow at least 84.00 inches (2133.6 mm) of aisle space.

Note: See **Table 20.2-6** for further information on assembly depth and recommendations for cables and conduits.

Non-Plenum

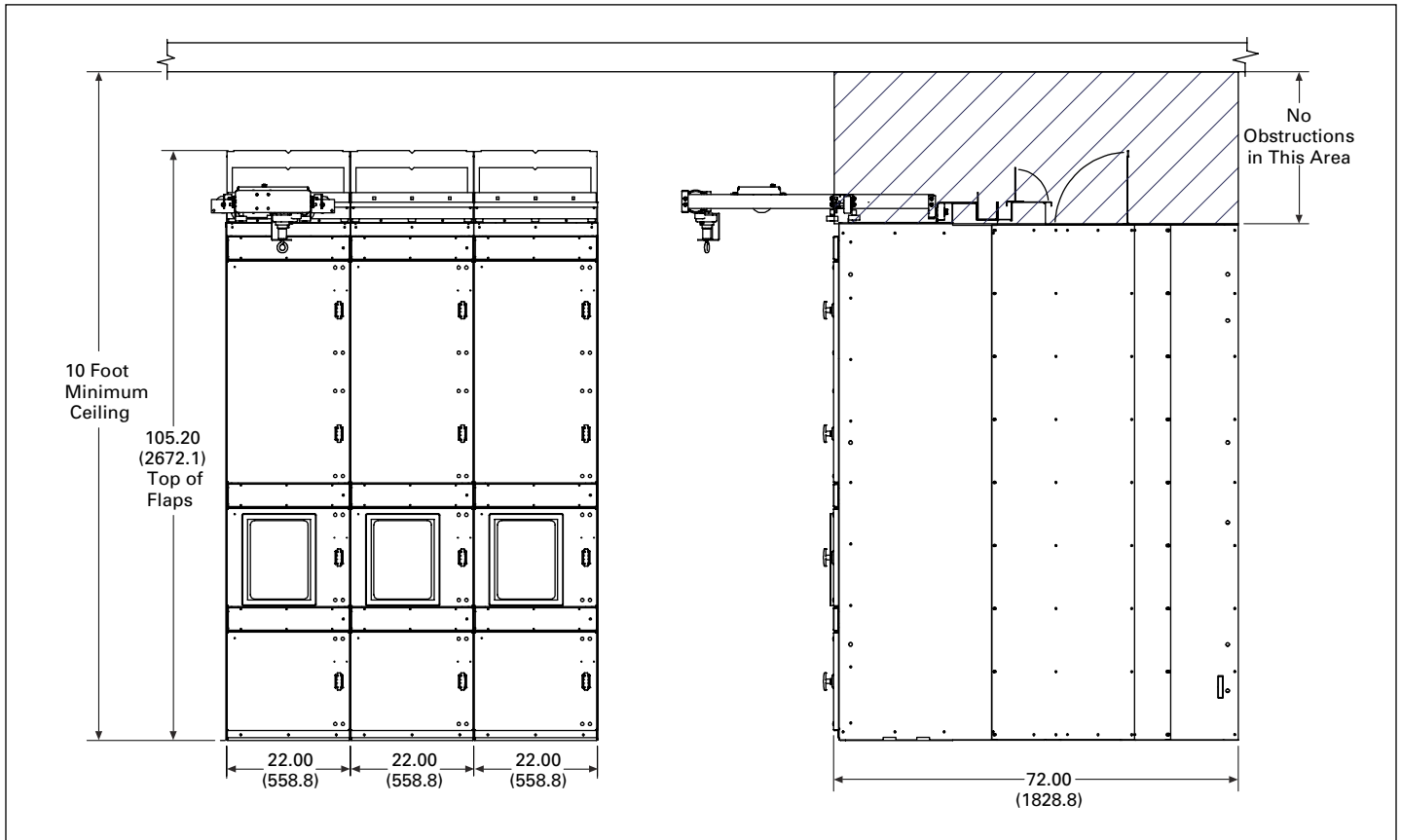

Figure 20.2-9. Non-Plenum Top Exit Configuration—Dimensions in Inches (mm)

Note: Contact Eaton for authorization of obstructions in this area.

Plenum

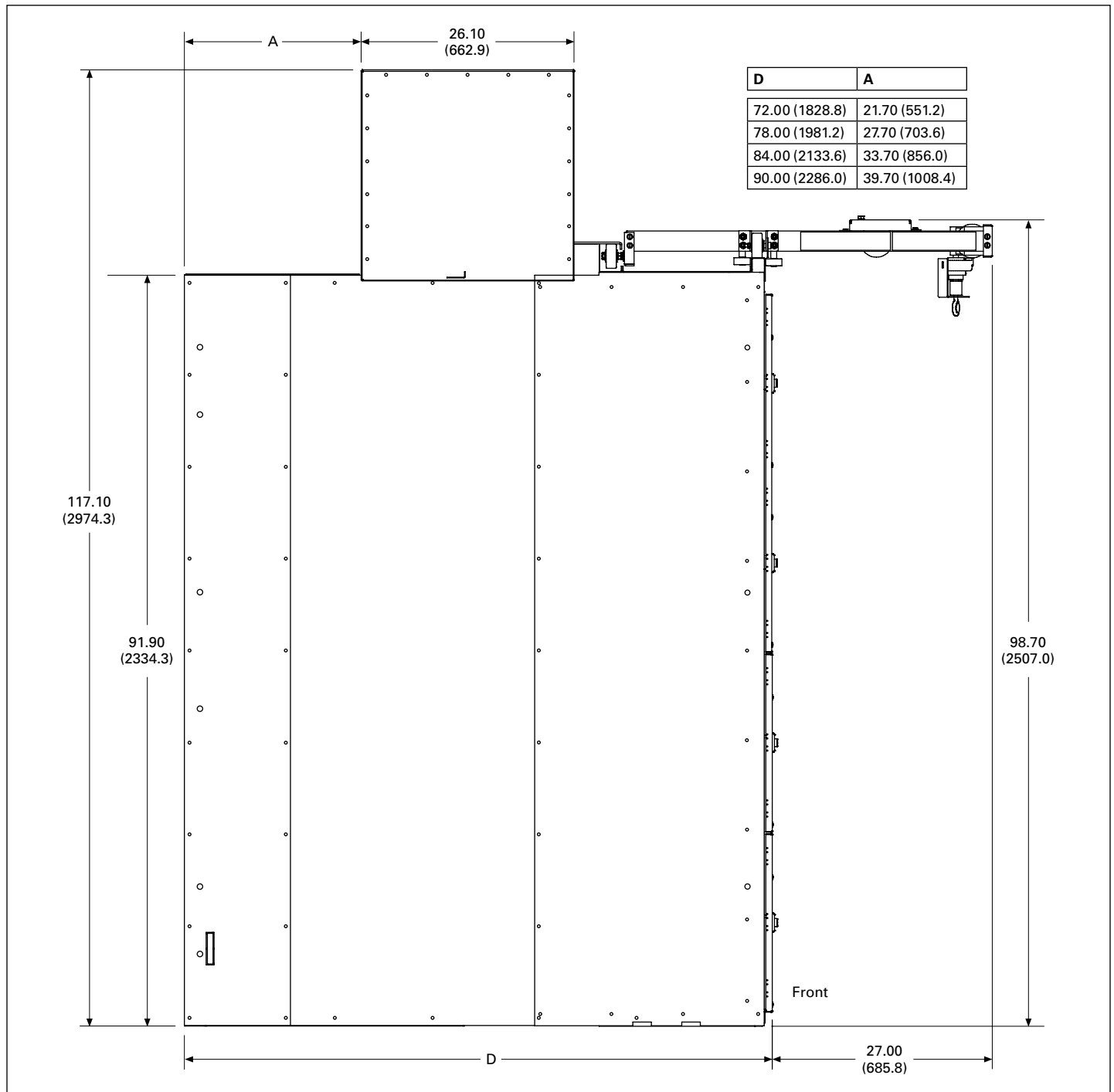

Figure 20.2-10. Arc-Resistant Switchgear Side View Showing the Arc Plenum—Dimensions in Inches (mm)

Note: Refer to Table 20.2-6 on Page 20.2-23 for complete dimensions.

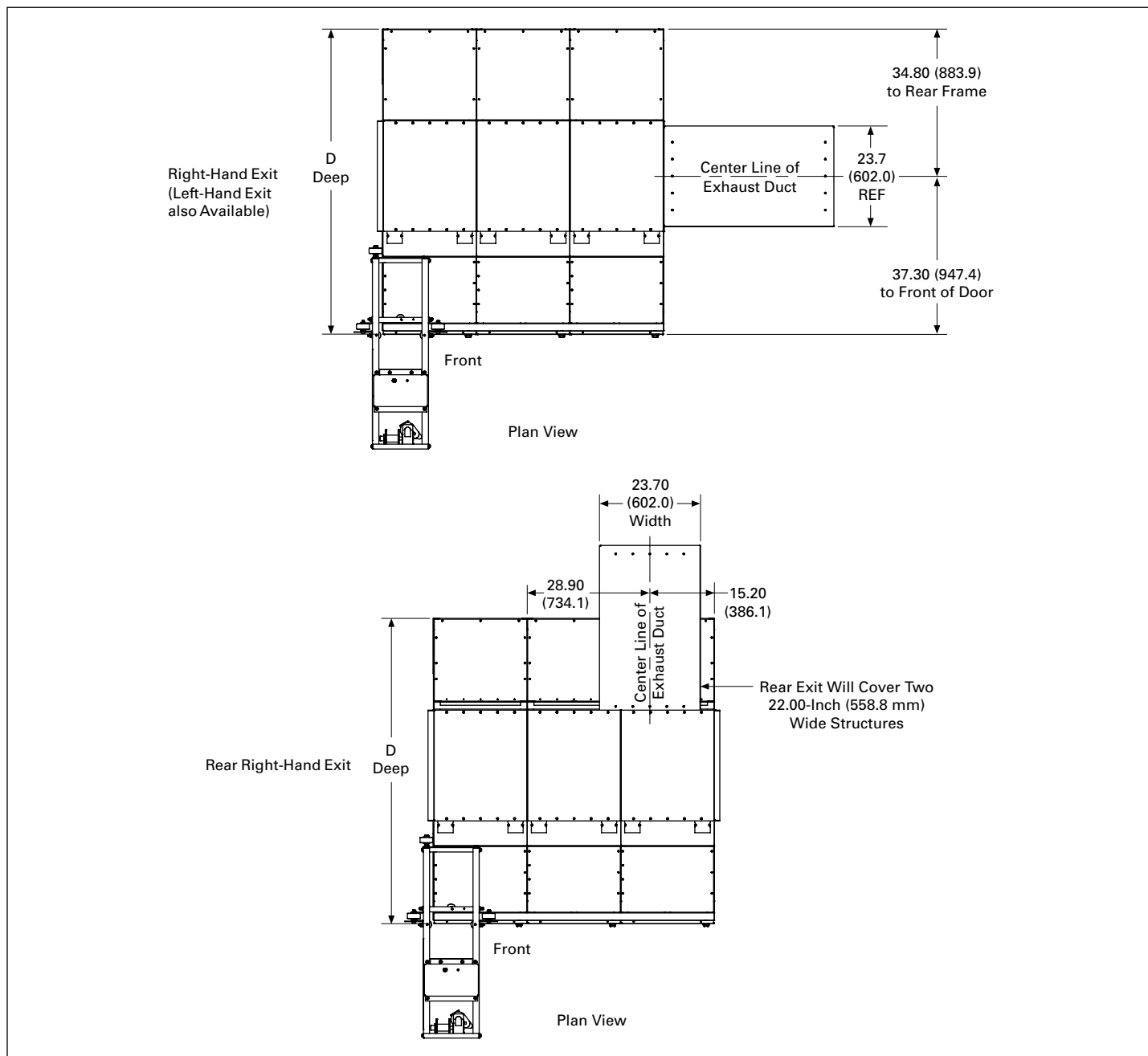

Figure 20.2-11. Arc-Resistant Switchgear Exhaust Configurations—Dimensions in Inches (mm)

Note: Gear shown with rear covers. Eaton arc resistant rating with or without plenum and arc duct are up to 85 kA at 635 Vac maximum and 100 kA at 508 Vac maximum.

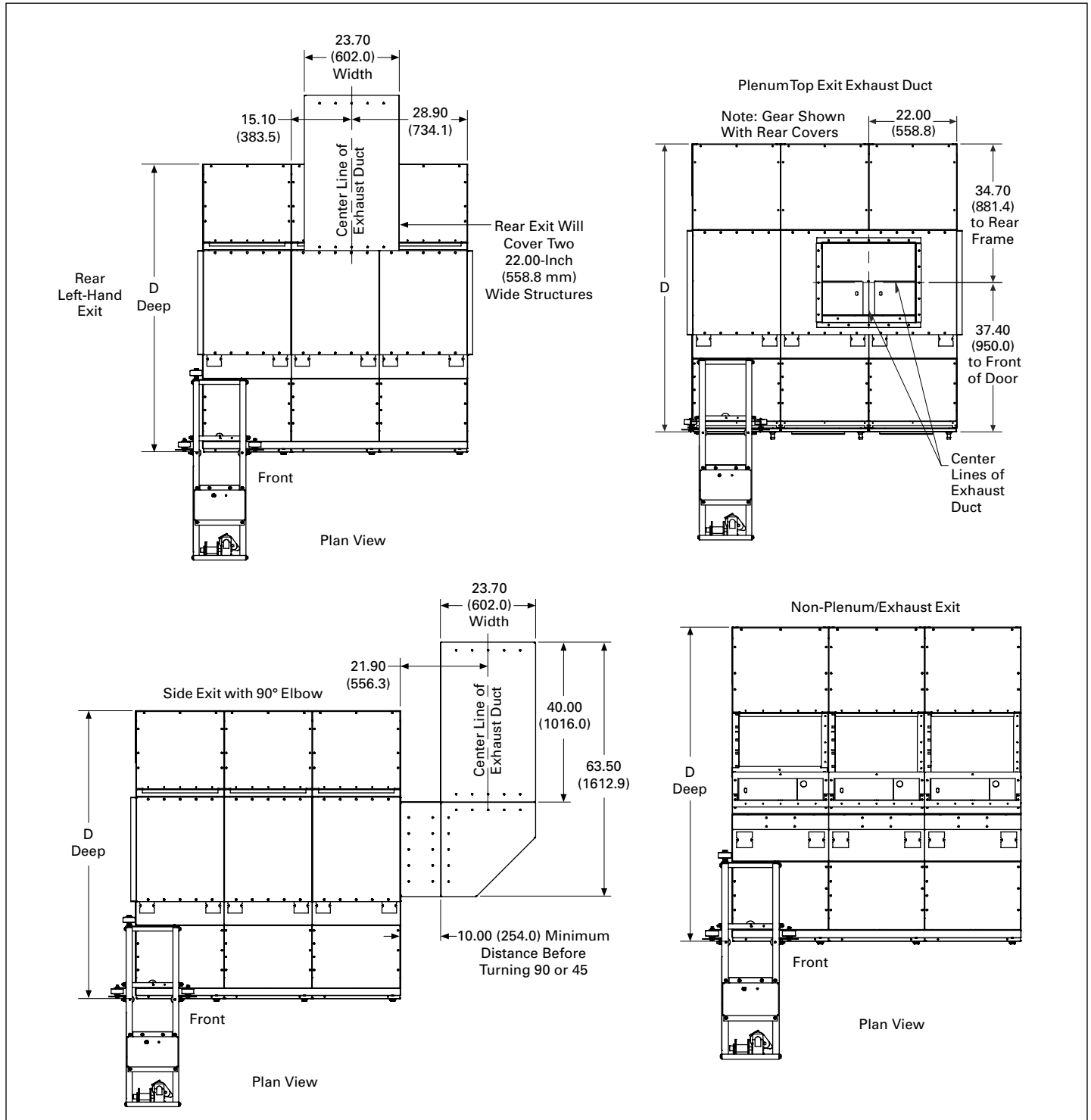

Figure 20.2-11. Arc-Resistant Switchgear Exhaust Configurations (Continued)

Note: Gear shown with rear covers. Eaton arc resistant rating with or without plenum and arc duct are up to 85 kA at 635 Vac maximum and 100 kA at 508 Vac maximum.

Typical Breaker Schematics

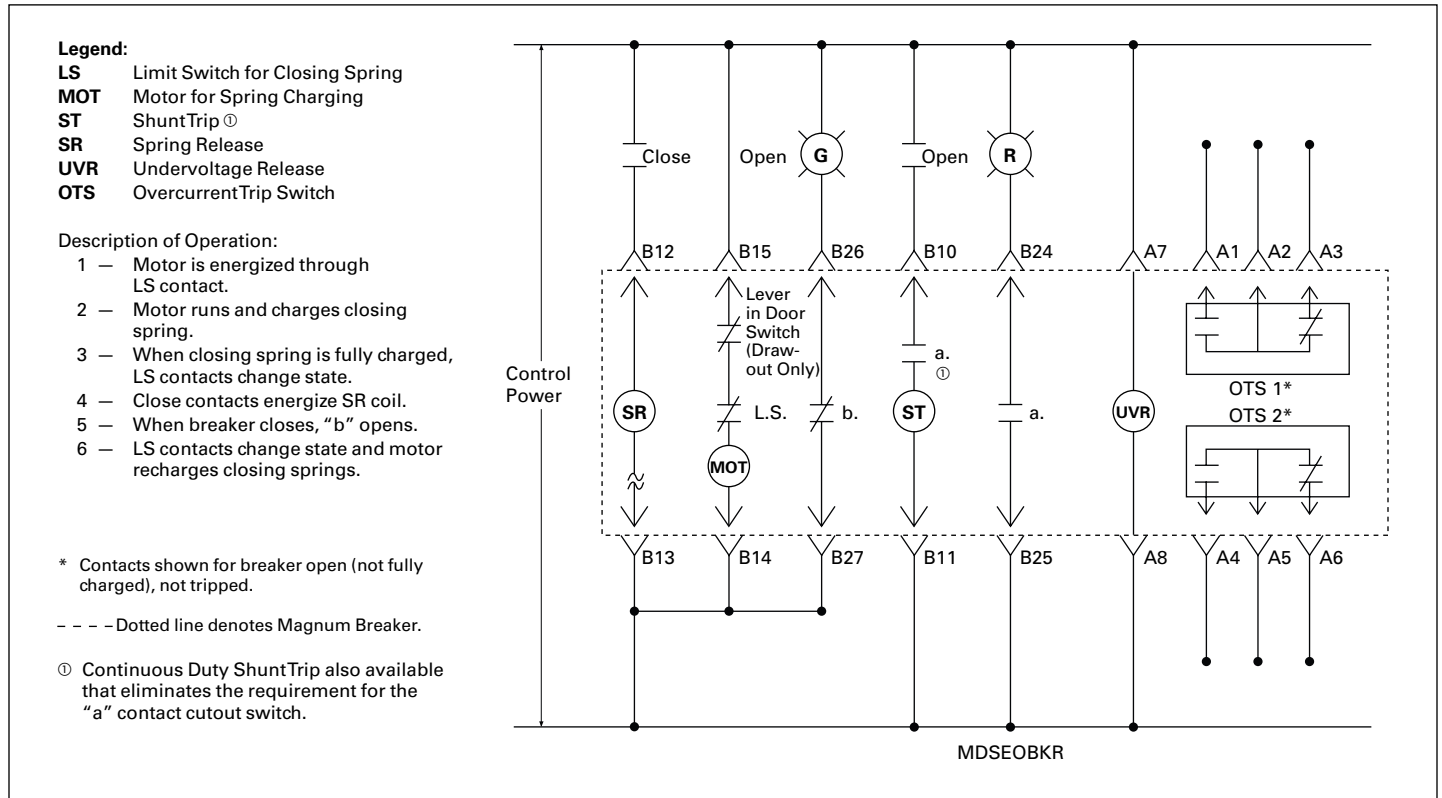

Figure 20.2-12. Typical Magnum Breaker Control Circuit Diagram

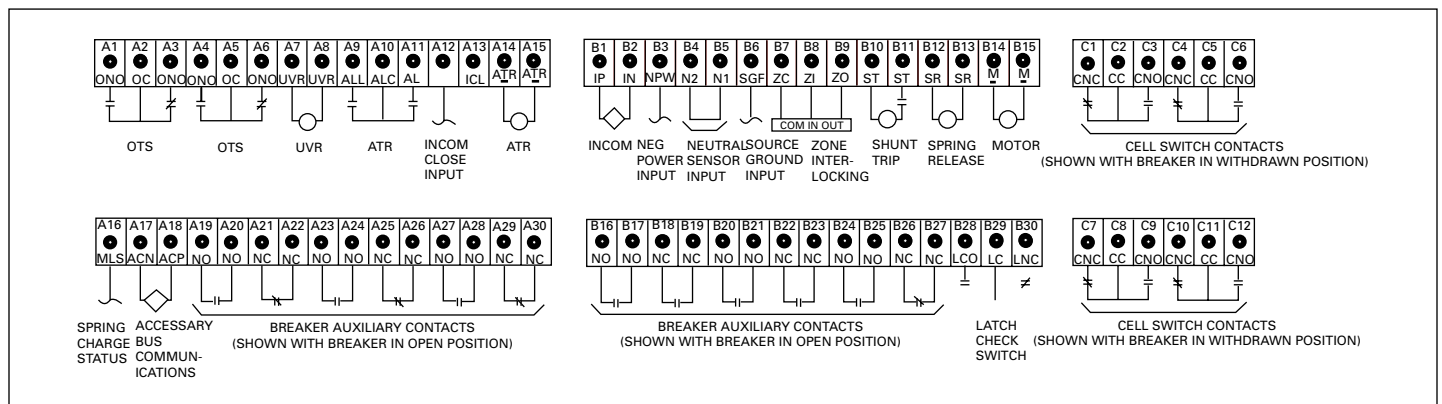

Figure 20.2-13. Typical Magnum Secondary Terminal Block Connection Diagram

Heat Loss

Table 20.2-8. Heat Loss Data ①

Estimated Heat Loss Per Breaker (Watts)

Breaker Frame	Drawout Mounting Only
800	150
1600	329
2000	374
3200	719
4000	749
5000	1000
6000	1440

Estimated Heat Loss Per Structure (Watts) ①

Loss is based on fully loaded vertical and cross bus rating in a structure as given below.

Rating	Vertical Bus	Cross Bus
2000	410	288
3200	1623	1163
4000	1097	1169
5000	1410	886
6000	2030	1265
8000	—	2240
10,000	—	3500

① For lower than maximum load currents, watt loss may be estimated by reducing the full load loss by the following:

$$W_L = (I_L/I_{FL})^2 W_{FL}$$

Where:

W_L = Load Watts

W_{FL} = Full Load Watts

I_L = Actual Load Current

I_{FL} = Full Load Current

Vertical section bus is sized per main cross bus maximum rating or by ANSI C37.20.1 to a maximum of 5000 A. (4000 A in 18.00-inch [457.2 mm] structure.)

Note: In addition to the available bus bracings shown in Table 20.2-2, the bus has been tested for short-circuit values of 85,000 A for a full 60 cycles.

Closing Times of Magnum DS and Series NRX Breakers

- 5 cycles or less

Table 20.2-9. Indoor 2000 A LVA Loss Analysis R2

Case 1		Double-Ended Losses	Each Main	Load of 50%				
Item No.	Quantity	Tie Open Load = 1806 Amperes Description	I_{FL} Full Load Rating	W_{FL} Watts Full Load Loss	I_L Actual Loading Amperes	Rating Factor	W_L Watts Item Loss	
1	1	2000 A 480 Main Bus	2000	700	903	0.204	142.70	
2	1	2000 A Main M1 Breaker	2000	775	903	0.204	157.99	
3	1	2000 A Distribution Section	2000	700	903	0.204	142.70	
4	1	800AF/500AT MDS Feeder CB	800	150	350	0.191	28.71	
5	1	800AF/400AT MDS Feeder CB	800	150	180	0.051	7.59	
6	1	800AF/300AT MDS Feeder CB	800	150	200	0.063	9.38	
7	1	800AF/200AT MDS Feeder CB	800	150	73	0.008	1.25	
8	1	2000 ATie and Section Bus	2000	675	0	0.000	0.00	
9	1	2000 A 480 Volt Distribution Bus	2000	700	903	0.204	42.70	
10	1	800AF/600AT MDS Feeder CB	800	150	403	0.254	38.06	
11	1	800AF/300AT MDS Feeder CB	800	150	175	0.048	7.18	
12	1	800AF/250AT MDS Feeder CB	800	150	150	0.035	5.27	
13	1	800AF/150AT MDS Feeder CB	800	150	75	0.009	1.32	
14	1	2000 A Main M2 Breaker	2000	775	903	0.204	157.99	
15	1	2000 A 480 Bus Main Bus	2000	700	903	0.204	142.70	
		Total with Each Main at 50% Load						985.52

Case 2		Single Ended Losses	One Main	Load of 100%				
Item No.	Quantity	Tie Closed Load = 1806 Amperes Description	I_{FL} Full Load Rating	W_{FL} Watts Full Load Loss	I_L Actual Loading Amperes	Rating Factor	W_L Watts Net Item Loss	
1	1	2000 A 480 Main Bus	2000	700	1806	0.815	570.79	
2	1	2000 A Main M1 Breaker	2000	775	1801	0.811	628.45	
3	1	2000 A Distribution Section	2000	700	903	0.204	142.70	
4	1	800AF/500AT MDS Feeder CB	800	150	350	0.191	28.71	
5	1	800AF/400AT MDS Feeder CB	800	150	180	0.051	7.59	
6	1	800AF/300AT MDS Feeder CB	800	150	200	0.063	9.38	
7	1	800AF/200AT MDS Feeder CB	800	150	73	0.008	1.25	
8	1	2000 ATie and Section Bus	2000	675	903	0.204	137.60	
9	1	2000 A 480 Volt Distribution Bus	2000	700	903	0.204	142.70	
10	1	800AF/600AT MDS Feeder CB	800	150	403	0.254	38.06	
11	1	800AF/300AT MDS Feeder CB	800	150	175	0.048	7.18	
12	1	800AF/250AT MDS Feeder CB	800	150	150	0.035	5.27	
13	1	800AF/150AT MDS Feeder CB	800	150	75	0.009	1.32	
14	1	2000 A Main M2 Breaker	2000	775	0	0.000	0.00	
15	1	2000 A 480 Bus Main Bus	2000	700	0	0.000	0.00	
		Total with One Main at 100% Load						1720.99

Note: Full Load of Section or Breaker comes from the frame or bus ratings of the product. Actual Amperes is a loading profile over all the devices for the operating scenario of interest. Rating Factor is a value that appropriately “weights” the nominal losses at full load to the actual losses for the actual loading value. The formula is Rating Factor = (Actual Loading/Full Load Rating) x (Actual Loading/Full Load Rating). The Rating Factor is applied (multiplied) by the Full Load Loss Watts to get NetWatts for each item. See Table 20.2-8 for Nominal heat loss data for devices and sections.

Weights

Center of Gravity

For seismic calculations, the following dimensions should be used to locate the center of gravity for Indoor Magnum DS switchgear.

Table 20.2-10. Center of Gravity Location

Dimensions in Inches (mm)		
Vertical	Left-to-Right	From the Front
60.00 (1524.0)	Center of lineup	26.00 (660.4)

Table 20.2-11. Magnum DS Indoor Rear Switchgear Structure Approximate Weights (Standard Construction Less Breakers) ①

Width in Inches (mm)	Depth in Inches (mm)	Approximate Weight in Lb (kg)
Breaker Structure		
18.00, 22.00 and 24.00 (4572, 558.8 and 609.6)	60.00 (1542.0)	1250 (568)
	66.00 (1676.4)	1300 (591)
	72.00 (1828.8)	1350 (614)
	78.00 (1981.2)	1400 (639)
	84.00 (2133.6)	1450 (659)
	90.00 (2286.0)	1500 (682)
30.00 (762.0)	60.00 (1542.0)	1900 (864)
	66.00 (1676.4)	2000 (909)
	72.00 (1828.8)	2100 (955)
	78.00 (1981.2)	2200 (1000)
	84.00 (2133.6)	2300 (1045)
	90.00 (2286.0)	2400 (1091)
44.00 (1176)	60.00 (1542.0)	2500 (1136)
	66.00 (1676.4)	2600 (1182)
	72.00 (1828.8)	2700 (1227)
	78.00 (1981.2)	2800 (1273)
	84.00 (2133.6)	2900 (1318)
	90.00 (2286.0)	3000 (1364)
60.00 (1524.0)	60.00 (1542.0)	3800 (1727)
	66.00 (1676.4)	4000 (1818)
	72.00 (1828.8)	4200 (1909)
	78.00 (1981.2)	4400 (2000)
	84.00 (2133.6)	4600 (2091)
	90.00 (2286.0)	4800 (2182)
Auxiliary/Transition Structures		
12.00 (304.8)	60.00 (1542.0)	475 (216)
	66.00 (1676.4)	500 (227)
	72.00 (1828.8)	525 (239)
	78.00 (1981.2)	550 (250)
	84.00 (2133.6)	575 (261)
	90.00 (2286.0)	600 (273)
18.00, 22.00 and 24.00 (4572, 558.8 and 609.6)	60.00 (1542.0)	950 (432)
	66.00 (1676.4)	1000 (455)
	72.00 (1828.8)	1050 (477)
	78.00 (1981.2)	1100 (500)
	84.00 (2133.6)	1150 (523)
	90.00 (2286.0)	1200 (545)
30.00 (762.0)	60.00 (1542.0)	1700 (773)
	66.00 (1676.4)	1750 (795)
	72.00 (1828.8)	1800 (818)
	78.00 (1981.2)	1850 (840)
	84.00 (2133.6)	1900 (864)
	90.00 (2286.0)	1950 (886)
Utility Structures		
38.00 (965.2)	60.00 (1542.0)	1600 (726)
	66.00 (1676.4)	1625 (738)
	72.00 (1828.8)	1650 (749)
	78.00 (1981.2)	1675 (760)
	84.00 (2133.6)	1700 (772)
	90.00 (2286.0)	1725 (783)
50.00 (1270.0)	60.00 (1542.0)	1650 (749)
	66.00 (1676.4)	1675 (760)
	72.00 (1828.8)	1700 (772)
	78.00 (1981.2)	1725 (783)
	84.00 (2133.6)	1750 (795)
	90.00 (2286.0)	1775 (806)

① See Table 20.2-12 on the following page for breaker weights.

Table 20.2-12. Magnum DS and Series NRX Breaker Weights

Breaker	Drawout in Lb (kg)
Narrow	
MDN-408	130 (59)
MDN-508	130 (59)
MDN-608	130 (59)
MDN-C08	145 (66)
MDN-416	130 (59)
MDN-516	130 (59)
MDN-616	130 (59)
MDN-C16	145 (66)
MDN-620	145 (66)
MDN-C20	145 (66)
Standard	
MDS-408	130 (59)
MDS-608	130 (59)
MDS-808	145 (66)
MDS-C08	145 (66)
MDS-616	130 (59)
MDS-816	145 (66)
MDS-C16	145 (66)
MDS-620	145 (66)
MDS-820	145 (66)
MDS-C20	145 (66)
MDS-632	175 (79)
MDS-832	175 (79)
MDS-C32	175 (79)
Double Wide	
MDN-640	310 (141)
MDN-840	310 (141)
MDN-C40	310 (141)
MDS-840	310 (141)
MDS-C40	310 (141)
MDS-850	310 (141)
MDS-C50	310 (141)
MDS-X50	345 (157)
MDS-C60	310 (141)

Note: Impact weight equals 1.5 times breaker static weight. Three-pole frame weight given; four-pole frame weight equals 1.33 times more.

Table 20.2-13. Magnum DS Arc-Resistant Switchgear Additional Approximate Weights

Arc-Resistant Component	Approximate Weight kg/Foot (m)
Plenum	34 (50.60)
Exhaust duct	38 (56.55)

Service Conditions

Standards

Magnum DS circuit breakers meet or exceed all applicable requirements of ANSI Standards C37.13, C37.17, C37.50 and CSA.

System Voltage and Frequency

Magnum DS breakers are designed for operation on AC systems only, 60 Hz or 50 Hz, 635 V maximum.

Continuous Current Ratings

Unlike transformers, generators and motors, circuit breakers are maximum-rated devices and have no built-in temporary overload current ratings. Consequently, it is vital that each application take into consideration the maximum anticipated current demand, initial and future, including temporary overloads.

The continuous rating of any Magnum DS breaker is limited to the sensor rating, or the frame size current rating, whichever is the lesser. For instance, an MDS-616 1600 A frame breaker with 800 A sensors has a maximum continuous rating of 800 A, but the same breaker with 1600 A sensors is limited to 1600 A maximum.

All current ratings are based on a maximum ambient air temperature of 40 °C (104 °F).

Ambient Temperature

The temperature of the air surrounding the enclosure should be within the limits of: -30 °C (-22 °F) to +40 °C (+104 °F).

Altitude

The breakers are applicable at their full voltage and current ratings up to a maximum altitude of 6600 ft (2012 m) above sea level. When installed at higher altitudes, the ratings are subject to the following correction factors in accordance with ANSI C37.20.1.

Table 20.2-14. Altitude Derating Factors

Altitude		Voltage Correction	Current Correction
Feet	Meters		
6600	2012	1.000	1.000
7000	2134	0.989	0.998
7500	2286	0.976	0.995
8000	2438	0.963	0.993
8500	2591	0.950	0.990
9000	2743	0.933	0.987
9500	2896	0.917	0.983
10,000	3048	0.900	0.980
10,500	3200	0.883	0.977
11,000	3353	0.867	0.973
11,500	3505	0.850	0.970
12,000	3658	0.833	0.967
12,500	3810	0.817	0.963
13,000	3962	0.800	0.960

All low-voltage air power circuit breakers are tested per the ANSI Standard C37.1 for a system X/R ratio of 6.6 maximum. It is common within low-voltage systems to experience power factor and X/R values outside the range of the standard values, and thus a means to evaluate published product ratings is necessary.

For applications of power breakers within distribution systems having calculated X/R ratios higher than 6.6, the derating of the air power breakers kAIC rating is required. Per IEEE sanctioned methodology, the calculated short circuit current at the point of interest is increased by the **Table 20.2-15** multiplying factors (MF) to yield an “apparent value of short circuit current,” which is then compared to the published breaker ratings. Only breakers having published ratings higher than the “apparent fault current” can be safely applied.

For example, if unfused air power breakers rated 65 kAIC were being considered within a 480/277 Vac distribution system where the X/R at the point of breaker application is 14.25 and the calculated fault current was determined to be 60 kA, the determination of the suitability of these breakers yields:

$$\begin{aligned} \text{Apparent Fault Current} &= 60 \text{ kA} \times \text{MF} \\ &= 60 \text{ kA} \times 1.112 \\ &= 66.72 \text{ kA} \end{aligned}$$

and therefore because 66.72 kA exceeds the 65 kAIC rating, the breakers are not adequate and higher rated kAIC breakers would need to be applied.

Table 20.2-15. Air Power Breaker Derating

System X/R Ratio	System % PF	Derating and Multiplying Factors for Air Power Breakers			
		Fused		Unfused	
		Derating	MF	Derating	MF
1.73	50.0	1.000	1.000	1.000	1.000
3.18	30.0	1.000	1.000	1.000	1.000
3.87	25.0	1.000	1.000	1.000	1.000
4.90	20.0	1.000	1.000	1.000	1.000
6.59	15.0	0.939	1.065	1.000	1.000
8.27	12.0	0.898	1.114	0.962	1.000
9.95	10.0	0.870	1.149	0.937	1.067
11.72	8.5	0.849	1.178	0.918	1.089
14.25	7.0	0.827	1.209	0.899	1.112
19.97	5.0	0.797	1.255	0.874	1.144

Unusual Environmental and Operating Conditions

Special attention should be given to applications subject to the following conditions:

1. Damaging or hazardous fumes, vapors, etc.
2. Excessive or abrasive dust.

For such conditions, it is generally recommended that the switchgear be installed in a clean, dry room, with filtered and/or pressurized clean air. This method permits the use of standard indoor switchgear and avoids the derating effect of non-ventilated enclosures.

3. Salt spray, excessive moisture, dripping, etc.

Drip shields in equipment rooms and space heaters in indoor weatherproof enclosures, may be indicated, depending upon the severity of the conditions.

4. Excessively high or low ambient temperatures.

For ambient temperatures exceeding 40 °C, and based on a standard temperature rise of 65 °C, the continuous current ratings of breaker frame sizes, and also buses, current transformers, etc., will be subject to a derating factor calculated from the following formula:

$$\sqrt{\frac{105^\circ \text{ Total} - \text{Special Ambient, } ^\circ\text{C}}{105^\circ \text{ Total} - 40^\circ \text{ Standard Ambient}}}$$

Circuit breakers are not adversely affected by very low outdoor ambient temperatures, particularly when energized and carrying load currents. The standard space heaters in weatherproof switchgear will raise the temperature slightly and prevent condensation.

Electrical components such as relays and instruments, however, must be applied within the manufacturer’s specified limits.

5. Exposure to seismic shock.

Magnum DS assemblies and breakers have been certified for applications through International Building Code 2009 (IBC) and California Building Code 2010 (CBC). Assembly modifications may be required, so such conditions must be specified.

6. Abnormally high frequency of operation.

In line with above, a lesser number of operations between servicing, and more frequent replacement of parts, may be indicated.