

Air circuit breakers with Power Xpert Releases PXR...

The new series

IZMX16 / IZMX40



... are ready to interact with operators via USB port.

EATON

Powering Business Worldwide

Performance list.

Circuit breakers IZMX offer a wide range of technical performance, accessories and settings to optimize the breaker for the individual application.

Breaker specifications

IEC/EN 60947	IZMX16			IZMX40			
Rated Current (I_n)	630 A, 800 A, 1000 A, 1250 A, 1600 A			800 A, 1000 A, 1250 A, 1600 A, 2000 A, 2500 A, 3200 A, 4000 A			
Type of circuit breaker	B	N	H	B	N	H	
Rated impulse withstand voltage (U_{imp} , VAC)	12000	12000	12000	12000	12000	12000	
Rated insulation voltage (U_i , VAC)	1000	1000	1000	1000	1000	1000	
Rated operational voltage (U_e , VAC)	690	690	690	690	690	690	
Ultimate breaking capacity (I_{cu} , kA)	240V 50/60Hz	42	85	85	66	85	105
	440V 50/60Hz	42	50	66	66	85	105
	690V 50/60Hz	42	42	42	66	75	75
Rated service breaking capacity (I_{cs} , kA)	240V 50/60Hz	42	50	66	66	85	105
	440V 50/60Hz	42	50	50	66	85	105
	690V 50/60Hz	42	42	42	66	75	75
Rated short-time withstand current (I_{sw} , kA)	1s/3s	42/-	42/-	42/-	66/53	85/66	85/66
Rated short-circuit making capacity (I_{cm} , kA)	440V 50/60Hz	88	105	145	145	187	231
	690V 50/60Hz	88	88	88	145	166	166
Lifespan		630A-1600A			800A-1600A	2000A	2500A-4000A
	Mechanical, w/o	10000			10000	10000	10000
	Mechanical, w maintenance	20000			20000	20000	20000
	Electrical, 440V, w/o maintenance	10000			10000	8000	6000
Dimensions (H x W x D, mm)	Fixed 3P	338x210x184			398x376x298		
	Fixed 4P	338x279x184			398x492x298		
	Withdrawable 3P	360x254x289			456x426x393		
	Withdrawable 4P	360x324x289			456x541x393		
Weight (kg)	Fixed 3P/4P	15/20			45/56		
	Withdrawable 3P/4P	39/47			98/121		

Trip unit specifications

	PXRV (Current) IZMX16/40...V...	PXRP (Power) IZMX16/40...P..
Protection functions	LI, LSI, (G)	LI, LSI, (G)
Overload protection (L)		
Overload trip (I_l), $\times I_n$	0.4 ... 1.0	0.4 ... 1.0
Long delay time t_l ($6 \times I_l$)	0.5 ... 24 s	0.5 ... 24 s
Short-time delayed short-circuit protection (S)		
Short delayed pickup (I_{sd}), $\times I_r$	1.5 ... 10	1.5 ... 10
Short delay time, flat characteristic curve (t_{sd})	0.0 ... 0.5 s	0.0 ... 0.5 s
Short delay time at $8 \times I_r$, I^2t curve (t_{sd})	0.1 ... 0.5 s	0.1 ... 0.5 s
Non-delayed short-circuit protection (I)		
Non-delayed pickup (I_i), $\times I_n$	OFF, 2 ... 15	OFF, 2 ... 15
Optional ground fault protection (G)		
Ground/Earth fault alarm (A), $\times I_n$	0.2 ... 1.0	0.2 ... 1.0
Ground/Earth pickup (I_g), $\times I_n$	OFF, 0.2 ... 1.0	OFF, 0.2 ... 1.0
Short delay time, flat characteristic curve (t_g)	0.1 ... 0.5 s	0.1 ... 0.5 s
Short delay time at $0.625 \times I_n$, I^2t curve (t_g)	0.1 ... 0.5 s	0.1 ... 0.5 s
Standard functions	Current measurement, status/Overload LED, cause of trip LEDs, over-temperature trip, thermal memory, zone selectivity ZSI, closing releases MCR, LCD display	as PXRV and additionally: voltage/power/energy measurement, waveform capture, communication (Modbus), trip log
Optional functions	Communication, Arcflash Reduction Maintenance System™ ARMS	Additional communication module, Arcflash Reduction Maintenance System™ ARMS

Eaton air circuit breakers - for cost-effective, optimized solutions.



The **IZMX16** is the smallest air circuit-breaker in his class worldwide:
With a volume of only 24 dm³ and a front surface of only 0.092 m² it is just slightly bigger than the size of a DIN A4 sheet of paper! And all this without any loss in terms of performance.

Because of its compact size it allows the user to create innovative concepts, like to install **two circuit** breakers side by side in withdrawable design, **in a 600 mm wide section**. This fact provides for a more cost-effective setup of the section and, in addition, it helps to save operating space. And where remote switching is required, this volume can even accommodate a motor for pre-tightening the stored-energy spring mechanism and some magnetic coils for the on/off command.

More performance in less space is simply impossible.



The **IZMX40** is a circuit breaker for up to 4000 A in a volume of a 3200 A circuit breaker, without the need to install any additional "busbar extensions" in the connection area.

Tests to integrate it into Eaton switchgear systems, such as Modan, xEnergy, PowerXpert, Capitol 20 and Capitol 40 confirm its outstanding technical performance and optimal compatibility thanks to the flexible connection system.

The modular structure, integrated detail solutions as well as a complete range of accessories and additional functions make it easy to adapt the circuit breaker to any of the required applications. Optionally it can be adapted right at the factory – without any extra cost or additional installation work at the circuit breaker.



Horizontal Terminal



Vertical Terminal

IZMX System Overview.

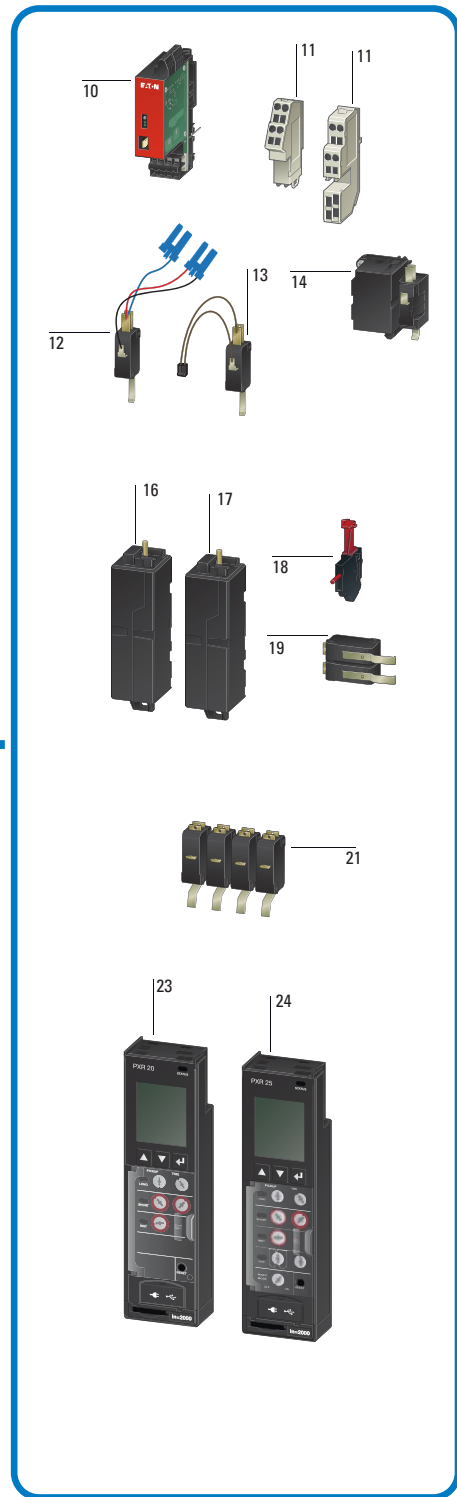
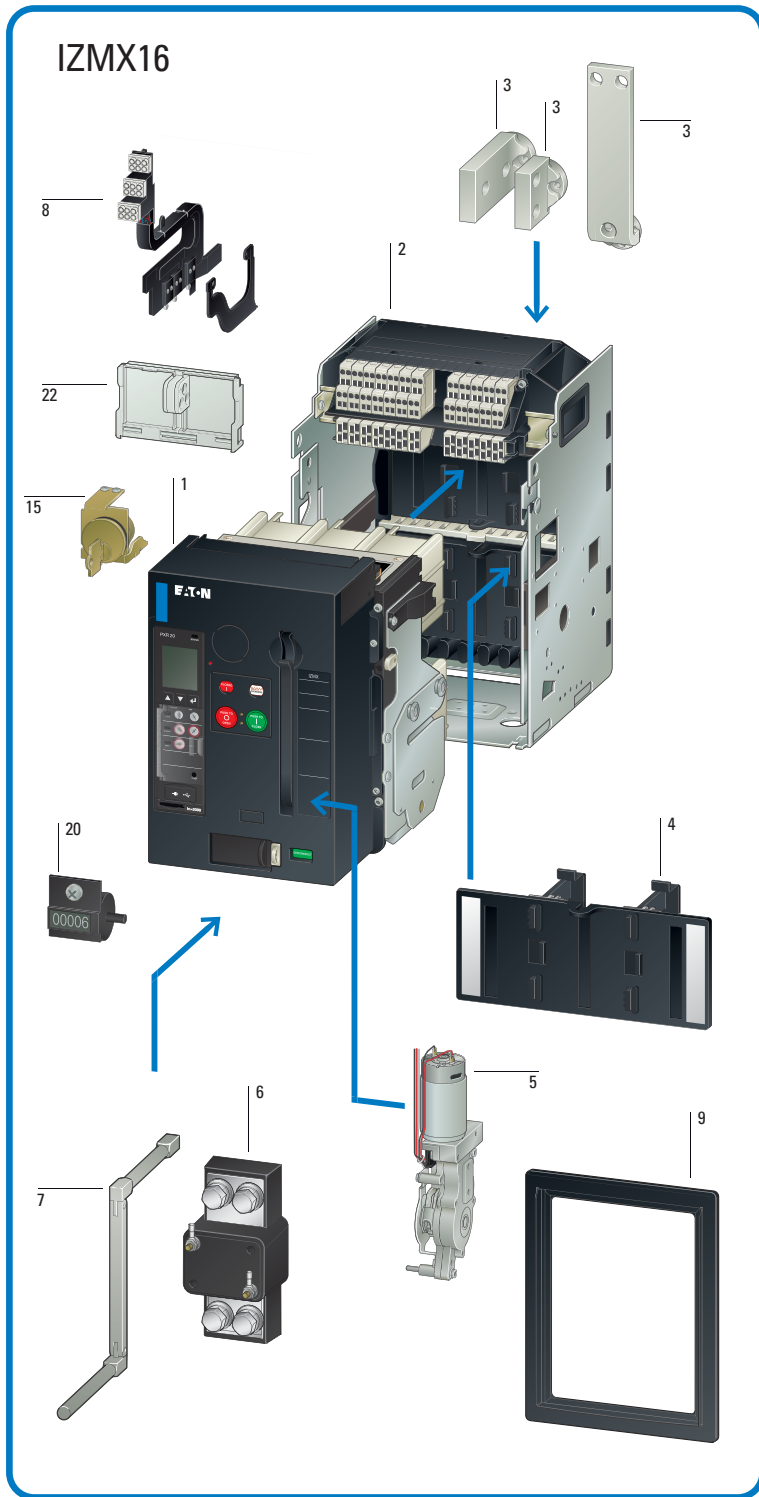

IZMX16, INX16, IZMX40, INX40

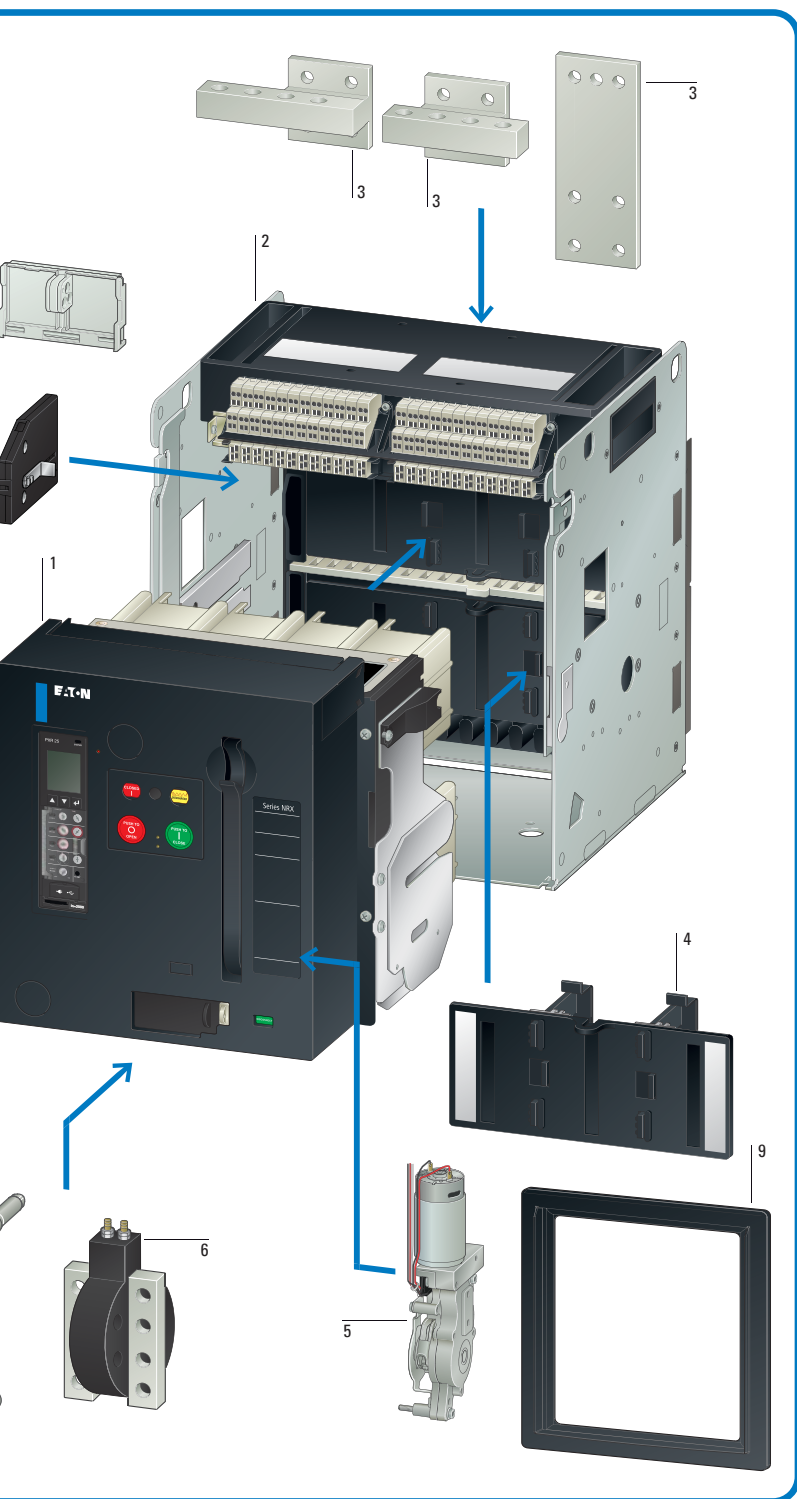

1 IZMX Circuit-breaker

IZMX16: 630 - 1600 A
IZMX40: 2000 - 4000 A

2 Cassette for withdrawable units

Shutters 3- and 4-pole
With and without control circuit terminals

3 Main terminal kits

Universal terminals, 3- and 4-pole
horizontal/vertical/front

4 Shutter

Shutter for 3- and 4-pole

5 Motor operator

Automatic charging of the spring force storage for remote or local operations

6 Current sensor for neutral conductor

Current sensor for sensing the neutral-conductor-current.

7 Levering tool

Convenient collapsible lev-in tool for lev-in and out operation of the Breaker in and out of the Cassette. The lev-in tool is stored inside the breaker.

8 Position cell switches

Cell switch signals the position of the breaker inside of the cassette. Connect, Test and Disconnect Position.

9 Door escutcheon

Closes the gap between Breaker and Switchgear-door. IP31. An IP55 protective cover is available as well

10 Communication modules

Profibus DP, Modbus, Ethernet and Modbus onboard

11 Control circuit terminal units

Either 2 or 12 units

12 Latch check switch

For external application usage.

13 Latch check switch

For use with closing release.

14 Closing releases

Closes the breaker by an electrical signal.

15 Key locking

Locking of the breaker by a keylock.

16 Shunt releases

Opens the breaker by an electrical signal.

17 Undervoltage releases

Opens the breaker by a voltage-drop in the control-circuit.

18 Red-pop trip indicator

Red-pop trip indicator signals a trip by the trip unit.

19 Trip indicator switches

Overcurrent trip switch (OTS) signals a trip by the trip unit for remove signalisation.

20 Switching operations counters

Counts the number of operations.

21 Auxiliary contacts

Signalling switch ON-OFF

22 Locking facilities

Plastic or metal

23 Trip unit - V

PXR20 LI, LSI, (G)
+ options

24 Trip unit - P

PXR25 LI, LSI, (G)
Modbus onboard + options

The next generation trip unit platform: Power Xpert Release (PXR)

The higher resolution dot matrix display has been enhanced to be always active, constantly displaying the status of

zone selectivity (ZSI), battery condition and rated current In. All data can be transferred via Modbus, Profibus or Ethernet

communication function and for security, a password can be added to avoid unauthorised changes. In addition, a QR

code has been added for easier identification and to access additional information.

Power Xpert Release (PXR) with multiple new features



- Modbus on board for PXR25 (optional for PXR20)
- Large LCD combined with cursor operation for more function and information
- Battery status, ZSI und In visible anytime
- ZSI – the better selective protection is always on board
- Password protection
- Rating plug programmable
- LSI protection can be changed to LI (without time selectivity) or LS (without Instantaneous = 100% selective)
- 3 free alarm contacts available
- USB port for testing and additional function setup via PC and software PXPM



- QR code for easier identification and further information



- Improved Diagnostics with breaker health (graph), events and run time

„Free download“ Software Power Xpert Protection Manager (PXPM) for interaction with PXR

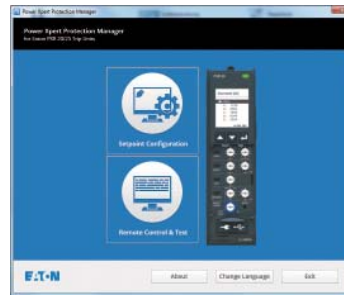

- Dis-/enable functions
- Reading/Changing settings (not basic protection settings)
- Waveform capture
- Multiple test procedures with final test protocol print including date/time stamp
- Print settings and curves

Using the software is easy and self explaining. The cursor above a select able function opens a window with its explanation. Depending on the selection next logical selection opens.

Testers no longer require specialized test tools thanks to the much better software solution in combination with the integrated secondary injection test hardware. An this free of charge.



The Power Xpert Release trip unit platform enables engineers to configure and test circuit breakers from a PC via a USB port. As a result, it is easier for users to interact with the trip unit and store or print test data so they can improve their control and maintenance regimes.

USB Commercial cable



Load your settings and record them.

If any values are changed a “final setting adjustments” screen shows the original and revised settings, highlighting any that were modified. The sheet can be saved or printed.

Parameter	As Found	As Left
Rating On	2000 A	2000 A
Maintenance Mode	OFF	OFF
Maintenance Mode Remote Control	Disable	Disable
Maintenance Mode Trip Label	2.5 s/m	2.5 s/m
Line Frequency	60 Hz	60 Hz
Reverse Feed Breaker	Forward	Forward
Long Delay Thermal Memory	OFF	OFF
Zone Selective Interlocking	OFF	OFF
Zone Delay Slope	1%	1%
Long Delay Pickup (m)	1.08 s/m	6.78 s/m
Long Delay Time	6.5 s	2 s
High Load Alarm Level	85 %	85 %
Short Delay Slope	Flat	Flat
Short Delay Pickup Level	3.0 s/m	3.0 s/m
Short Delay Time	0.25 s	0.25 s
Instantaneous Pickup	1 x In	1 x In
Ground Sensing Type	Source/Zero Sens	Source/Zero Sens
Local Ground Fault Protection Type Setting	Alarm	Alarm
Ground Fault Slope	4%	4%
Ground Fault Pickup	1.0	1.0
Ground Fault Trip Time	0.5 s	0.5 s
Mechanical Protection Rate	100%	100%

High current circuit breakers, for example those used in high power distribution systems in industry, are configured and periodically tested by end users

to ensure they continue to work reliably in case of over-currents, and therefore prevent expensive downtime. This new unit allows technicians to simulate or

inject overloads, short circuits, ground faults, do internal current transformer test including its wiring, test with or without tripping and much more using

the Software Power Xpert Protection Manager (PXPM).

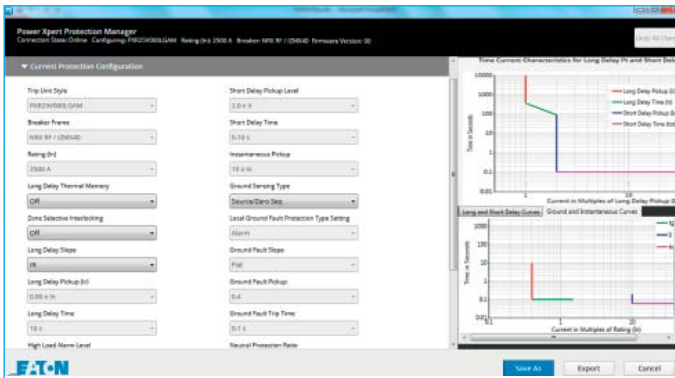

Dis-/Enable or change settings, enlarge tripping curves and print curves for documentation.

Utilizing the easy-to-use dashboard, Control Mode can be selected allowing diagnostic and meter data to be reset. In Test Mode individual phases can be tested against values entered as current value or as a multiplier of individual settings.

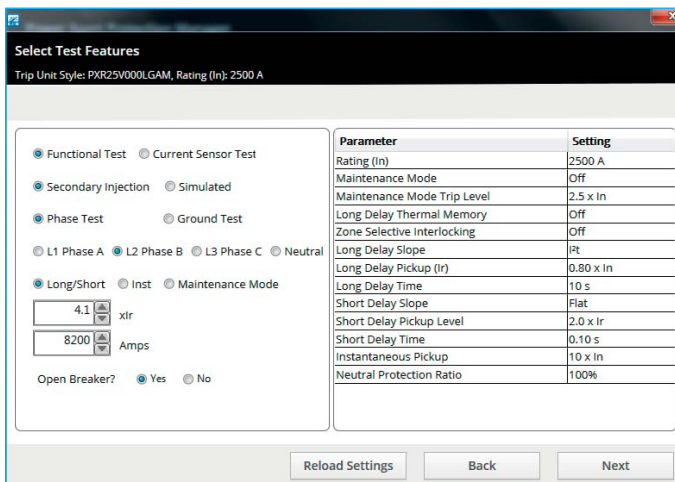

Select the function you want to test and choose the test current as value or multiplier of setting.

The unit has been developed in response to user demand for an easy-to-use system. Previously test data had to be written down, but with the upgraded software a three page professional test report with date/time stamp, customized information, individual settings/ tripping curves and secondary injection test result, can be generated and stored electronically in a pdf format. This enables technicians to significantly reduce the time it takes for testing, makes it much easier for them to carry out their maintenance, and receive a test report for documentation.

Prior to printing the test report, the customer name, location, environment and equipment condition can be entered.

Report professional all your test results within one document after installation in your system or report your yearly inspection that might be requested in your company.

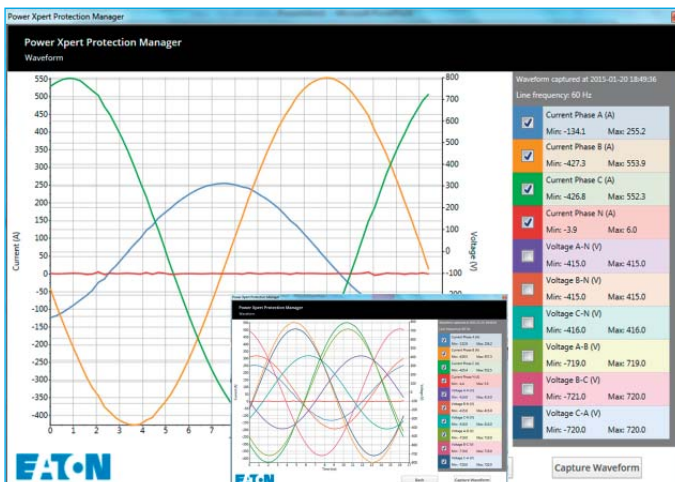

Get additional information by capturing the waveform and select which curves shall be visible or be printed.

New features include the ability to capture current and optional voltage waveforms along with minimum and maximum values for the phase and neutral conductors. In addition, the waveform can give an indication of the overall quality caused by harmonics, and metering accuracy is now one per cent "of reading".

Safety - individual solutions combined with IZMX.

Adding individual solutions to IZMX circuit breakers provides both more protection for systems and more safety for personnel in case there is a failure. And it also reduces the risk of unintended interruptions of operation.

- These solutions include:
- ARMSTM
 - ARCON®
 - Zone selectivity
 - Remote switching
 - Testing and documenting with PXP



ARMSTM (Arcflash Reduction Maintenance System)

Eaton's patented Arcflash Reduction Maintenance System AMRS technology provides maintenance staff improved safety of downstream maintenance locations using a simple and reliable method to reduce fault clearing times and energy in an arc flash event (radiation, sound, pressure, temperature).

Arcflash Reduction Maintenance System uses a separate analog trip circuit providing faster signal processing and interruption times than the standard (digital) "instantaneous" protection.

The Arcflash Reduction Maintenance System function is activated either directly on the circuit breaker through a local switch or remotely through communications or a contact input.

Arcflash Reduction Maintenance System is optional on both PXR20 and PXR25 trip units.



ARCON®

IZMX breakers, combined with ARCON®, help users to avoid damage and to protect people against arc faults as they can effectively be brought under control within 2 ms. They also protect against arc flashes that – due to their impedance - would not even cause a protective device to react.

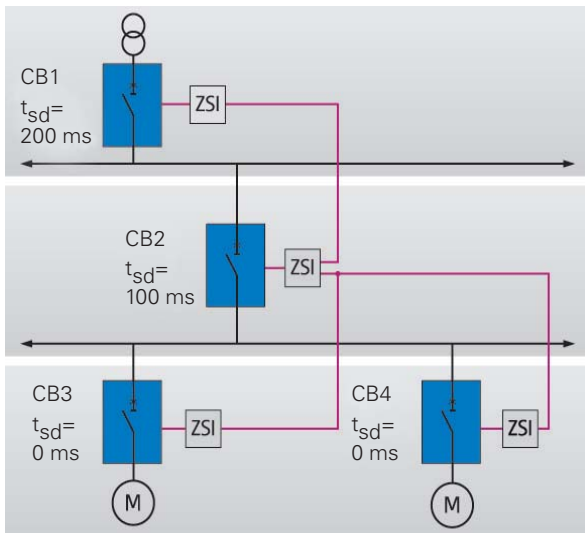

Zone selectivity ZSI

Now always on board an can be enabled.

Circuit breakers are directly connected to a signal line, without any additional modules. So, in case of short circuits, they ensure that only the circuit breaker immediately upstream the point of failure will break a short-circuit without delay.

The advantage of the zone selectivity feature – compared to ordinary time selectivity - is the significantly reduced delay time until tripping.

This reduces the thermal and dynamical load that protect the system in addition. In cases of a signal wire damage the back-up time selectivity ensures the selectivity of the system.

For additional safety of maintenance staff we recommend a combination with ARMS® to reduce the released amount of energy even further.



Remote switching

Remote switching requires two magnetic coils (shunt trip and closing release).

These coils will activate the mechanism of the ON and OFF buttons. After two switching actions have been carried out, a stored-energy spring mechanism needs to be retightened manually. With an additional motor drive, the retightening action can be automated.

Safety: If the second switching action was an ON action, a third action for switch-off or tripping through the energy of the spring will be ensured.

Safety: OFF commands will always be given priority. A permanent command for the operating-current trip enables the user to lock the circuit breaker in the OFF position.

Thanks to the powerful stored-energy spring, the circuit breaker will carry out the switch command sent to the magnetic coil in less than 35 ms. So the IZMX series circuit breakers are suitable for synchronisation tasks.



Breaker rear side (Drawout breaker)

Easy inspection and maintenance

Inspection and maintenance can be conveniently performed on the draw-out breaker as the primary finger clusters (blue) and levering mechanism are part of the breaker instead of the cassette.

Eaton also offers many field installable accessories and parts, extending the life of the breaker.

Increased operating safety and flexibility based on communication.

Profibus-DP

Modbus

Ethernet



IZMX

Thanks to its ability to communicate, the IZMX circuit breaker series taps new opportunities for power distribution. It provides all the information that is relevant for operation and forwards it.

This way the transparency of the system can be increased and response times to statuses

such as overcurrent, phase imbalance and overvoltage can be reduced. By quickly intervening in a process, system standstills can be prevented or preventive maintenance actions can be planned.

Consequently, the availability of the system can be increased as well.

With the respective communication module – PCAM, MCAM or ECAM (Profibus-DP / Modbus / Ethernet Communications Adapter Module) – every circuit breaker of the IZMX series is equipped for modern communication and is fit for the future. The databus not only allows to transmit information, but also to receive commands/settings.

Onboard Modbus communication is standard on the PXR25 (P type) trip unit and optional on the PXR20 (V type) trip unit upon order. Additional PCAM, MCAM or ECAM module can be installed externally for PXR25 to expand the communication capability.

Convenience for planning, selection and documentation

Eaton xEnergy Configurator for Circuit Breakers

The intuition-based software tool makes it easy to select and configure circuit breakers and load disconnectors with their respective accessories from a database of several thousand articles.

It does not require any special knowledge of the system. With just a few clicks you can select any switchgear configuration and transfer it to the parts or ordering list. All combination possibilities are saved in the software logic, which ensures correct ordering. In a logical step-by-step order, the software

will guide you through the switchgear offer and the suitable accessories. The selection process starts with choosing the appropriate standard, i.e. IEC or UL/CSA, the rated operating voltage and the rated frequency.

In the following steps you will need to:

- Determine the number of poles
- Choose a circuit breaker or load disconnecter
- Choose the protection task (e.g. motor protection, cable/line protection)
- Decide on either fixed or withdrawable design

Download from: www.eaton.eu/configurator



CurveSelect

CurveSelect allows the user to simultaneously display setup-specific tripping curves of several protective devices – both in terms of time and electric current values.

This tool makes it easy for the user to analyze the interaction of NZM and IZM circuit breakers, PKZ motor-protectors, motor-protective relays, MCCBs and h.b.c. fuses.

Freely defined curves (Free-StyleCurves = FSC) enable the user to directly compare the

- selected motor protector and motor starter characteristics,
- incoming supply switches and up-stream medium-voltage protection
- intended expansions and existing protective equipment

Download from: www.eaton.eu/curve

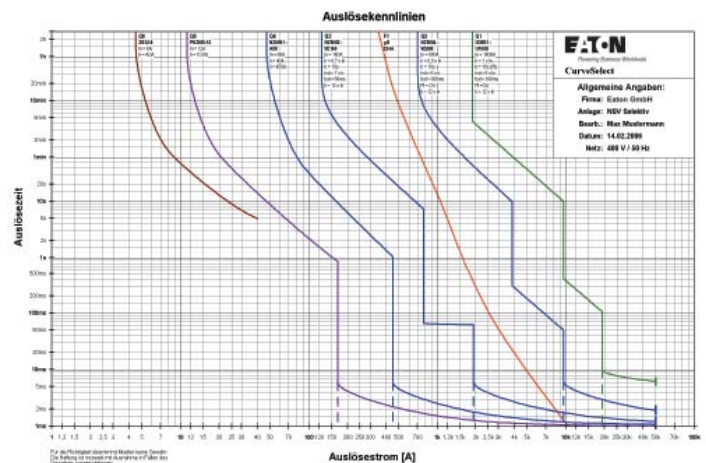

BreakerVisu

BreakerVisu allows the user to monitor several ACBs and MCCBs and helps him to quickly detect and clearly visualize the status of circuit breakers, such as currents, switching statuses or load warnings, and to dynamically visualize them on an http page.

In addition, all events will automatically be recorded in a log file.

This information is necessary to correctly evaluate warnings and malfunctions and to take the appropriate steps. Keeping a log file will also enable you to carry out an additional error analysis. BreakerVisu is composed of ready-made hard and software components. So no special software needs to be installed on the PC. All you need is an Internet browser and Microsoft Excel!

Download from: www.eaton.eu/breakervisu



Eaton is a power management company with 2015 sales of \$20.9 billion. Eaton provides energyefficient solutions that help our customers effectively manage electrical, hydraulic and mechanical power more efficiently, safely and sustainably. Eaton has approximately 97,000 employees and sells products to customers in more than 175 countries.

For more information, visit www.eaton.eu.



To contact an Eaton salesperson
or local distributor/agent, please visit
www.eaton.eu/electrical/customersupport

Eaton Industries (Austria) GmbH
Schedygasse 42
1210 Wien
Austria

Eaton Industries Manufacturing GmbH
EMEA Headquarters
Route de la Longeraie
1110 Morges
Switzerland

© 2016 Eaton Industries (Austria) GmbH
Subject to technical modifications. No
responsibility is taken for misprints or errata.
Printed in Austria (08/16)
Publication number BR01305001Z-EN