

Power Xpert Architecture
Compact power quality meters

Power Xpert Meter 2000



EATON

Powering Business Worldwide



Power Xpert Meter

Next generation compact power quality meter

You can't manage what you can't measure, and you certainly can't measure something you can't even see—without a power quality instrument, that is. Invisible and fleeting power quality problems can be silent killers—the electronic equivalent of high blood pressure.

The Eaton® Power Xpert® Meter 2000 represents a new niche in compact power quality instruments and comprehensive world-class power measurement and monitoring that helps reduce day-to-day operating costs and helps avoid costly business interruptions.

Energy management

This compact meter is an excellent fit into your energy management solution. Providing an extensive array of data, including energy and demand readings, you can manage energy utilization to help reduce peak demand charges and power factor penalties, and to identify excessive energy consumption. With this information at your fingertips, you can reduce your overall energy usage, and better manage your energy costs.

The Power Xpert Meter helps you to go GREEN

The Power Xpert Meter includes components that can help a building to go green and qualify for Leadership in Energy and Environmental Design (LEED®) credits through the U.S. Green Building Council (USGBC).

Comparing month-to-month energy usage—go GREEN

The Power Xpert Meter establishes a baseline of your energy usage. It allows you to easily compare month-to-month energy usage by automatically storing the energy data for exporting detailed analysis, for example, into Excel®. Receive periodic e-mail alerts on energy consumption or triggered by thresholds you have set, to remind you and to help you achieve your savings goals.



An Eaton Green Solution

Power Xpert Meter 2000

Next generation compact power quality monitoring and management is now as easy as surfing to it with your Web browser

Web-enabled

The Power Xpert Meter 2000 is a Web-enabled (includes a built-in Web server) next generation compact power quality meter with comprehensive power measurement and integrated quality analysis. The meter allows you to use a standard Web browser to surf the meter and record and view waveforms and analyze trends.



- 1 Reading type indicator
- 2 Menu
- 3 Navigation button: Enter
- 4 Parameter designator
- 5 Configurable auto scroll
- 6 Percent of load bar
- 7 Navigation button: Down
- 8 Navigation button: Right
- 9 Scaling factor
- 10 Watthour test pulse

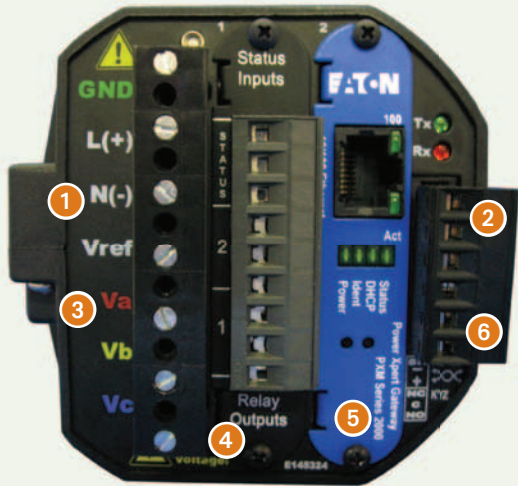

- 1 Power supply inputs
- 2 RS-485
- 3 System voltage inputs
- 4 I/O slot
- 5 Meter Gateway Card
- 6 KYZ out

Power Xpert Meter 2000

Innovative. Intuitive. Accurate. Accessible.

The meters combine state-of-the-art technology with harmonic viewing, data trending, performance benchmarking and waveform recording. The embedded Web server enables users to surf to the meter from any location via a standard Web browser. This platform offers advanced functionality such as field-upgradeable firmware and optional digital inputs and relay/analog outputs.

Applications

Identify power quality problems to help:

- Protect motors from damage
- Preserve the integrity of processes and batches
- Prevent blown capacitor bank fuses
- Protect transformers and conductors from overheating

Monitor circuit loading to help:

- Avoid overloads and nuisance overload trips
- Maximize equipment utilization
- Manage emergency overloads

Manage energy utilization to help:

- Reduce peak demand charges and power factor penalties
- Identify excessive energy consumption



Features and benefits

- Embedded Web server—see and analyze waveforms, demand comparisons, trends and harmonics directly in your Web browser
- Comprehensive power, energy and demand measurements for over 100 standard data points logged
 - Voltage, current: per phase minimum, maximum, average, trend graph analysis, export, print
 - Power: apparent, real, reactive, power factor
 - Energy: forward, reverse, net, sum
 - Demand: forward, reverse, net, sum, profile, export, print, graph analysis
- Support continuous, non-disruptive monitoring with a permanently installed meter
- Dramatically improve your ability to benchmark energy usage using graphical comparison views
- Alarm notifications are also available remotely via e-mail
- Use industry-standard communication protocols to support a multitude of configurations and third-party software: HTTP, HTTPS, Modbus® RTU, Modbus TCP, BACnet/IP, SNMP, SMTP, NTP
- Up to 768 MB data storage capability
- Supported via Power Xpert Software and Power Xpert Architecture hardware components
- ANSI C12.20 (0.2) accuracy

Power Xpert Meter 2000

The PMX 2000 home page—the “eyes” into your facility

The Power Xpert Meter home page, viewed in a standard Web browser, summarizes the top-level critical power quality information on a single page. Complex power quality data is presented in useful and simple graphical charts and gauges.

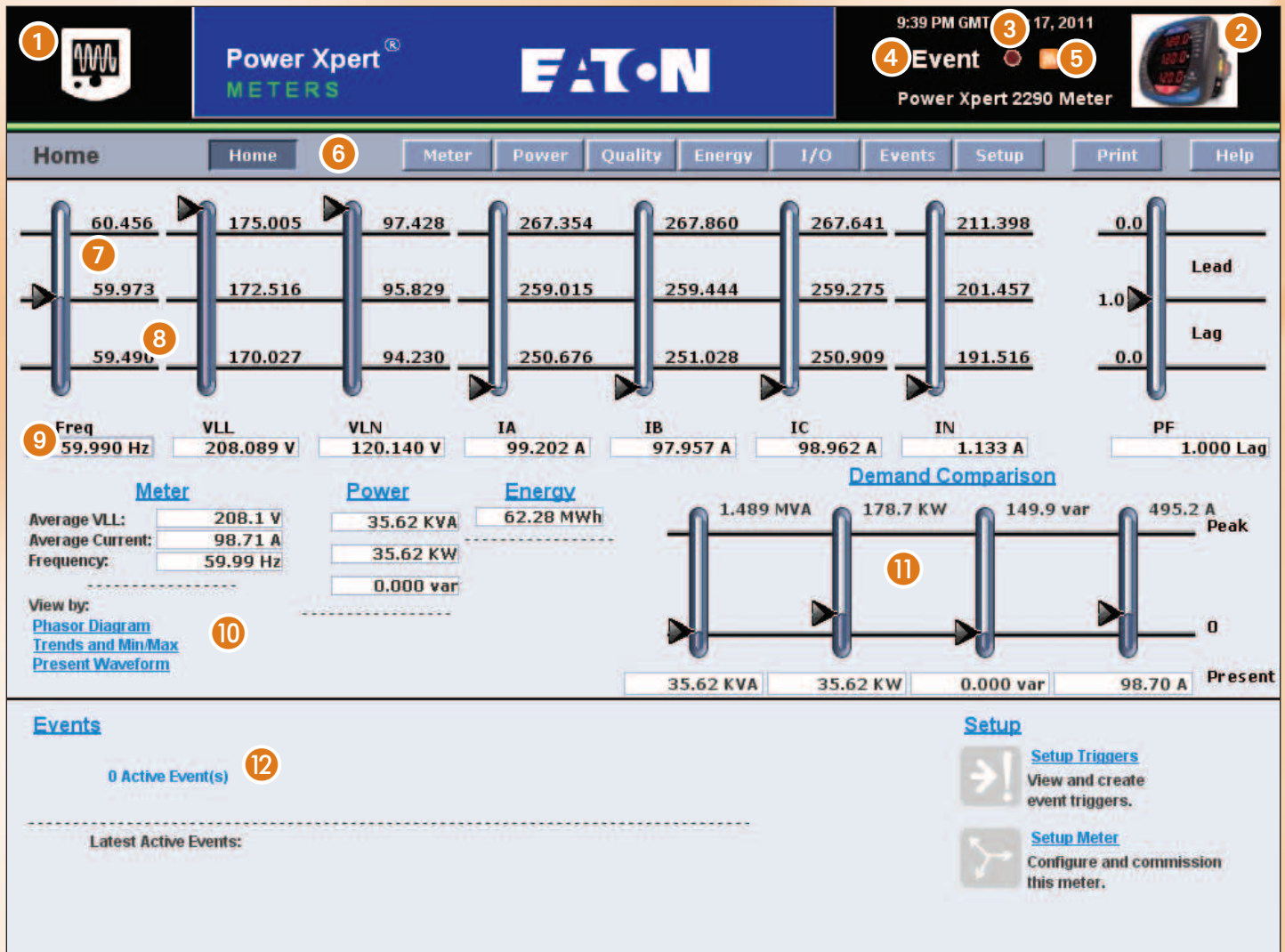

- 1 Power Xpert device type icon
- 2 Picture of device
- 3 Time stamp
- 4 Event LED
- 5 Meter event RSS feed
- 6 3D function button bar
- 7 3D mercury-filled voltage, current, frequency and power factor gauges
- 8 3D arrowhead pointing to present reading
- 9 Measurement parameters
- 10 Underlined Web links
- 11 Demand chart
- 12 Active events

Power Xpert Meter 2000

Five flavors of power monitoring

The Power Xpert Meter 2250

This meter provides all the core functions for monitoring power consumption and power quality along with 256 MB for data logging, Ethernet connectivity and onboard Gateway Card limits. This unit uses D/A technology to sample circuits at 400 samples per cycle for accurate measurement of power factor and energy consumption.

The Power Xpert Meter 2260

This meter adds the ability to monitor total harmonic distortion and the ability to set onboard meter limits. The meter also will illuminate LEDs on the faceplate, indicating that a limit has been exceeded. This meter comes standard with 512 MB for data logging.

The Power Xpert Meter 2270

This meter adds the ability to monitor individual harmonics and to visualize waveforms on your desktop using the embedded Web server. This meter comes with 768 MB for data logging.

The Power Xpert Meter 2280

This meter has all the capability of the PXM 2270 with the added capability to record waveforms at up to 64 samples per cycles. Also has the capability to configure the total, pre- and post-event cycles.

Power Xpert Meter 2290

This meter has all the capability of the PXM 2280 with the added capability to record waveforms at up to 512 samples per cycles.

Features and benefits of the Power Xpert Meter 2000 Series*

Feature	Power Xpert Meter					Benefit
	2250	2260	2270	2280	2290	
General						
Embedded Web Server	■	■	■	■	■	Use a standard Web browser to monitor and manage the meter over the network, Internet
Firmware flash update support	■	■	■	■	■	Enables you to flash the meter with the latest firmware updates
Power, Energy and Demand						
Voltage, current: per phase minimum, maximum, average, trend graph analysis, export, print	■	■	■	■	■	Review voltage and current trends, export, print and analyze parameters right on the meter or external software
Demand plot comparisons month-to-month, week-to-week	■	■	■	■	■	Plot two months or two weeks for vivid demand comparison
Power, apparent, real, reactive, power factor	■	■	■	■	■	Review power usage and power factor and avoid potential PF penalties
Energy, demand: forward, reverse, net, sum, TOU, profile, export, print	■	■	■	■	■	Keep track of your energy usage, identify peaks to conserve energy usage
Power Quality Analysis						
Statistical analysis (minimum, maximum, average)	■	■	■	■	■	Review statistical trends, identify past and future problem areas
Sampling rate, maximum samples/cycle	400	400	400	400	400	High sampling rate resulting in high accuracy
Security						
Secure two level user access privileges	■	■	■	■	■	Define appropriate security access level per user

* These specifications are subject to change without notice and represent the maximum capabilities of the product with all options installed. This is not a complete feature list. Features and functionality may vary depending on selected options, firmware version and product model. Please refer to the technical data sheet and the user manual for detailed specifications.

Features and benefits of the Power Xpert Meter 2000 Series*, continued

Feature	Power Xpert Meter					Benefit
	2250	2260	2270	2280	2290	
Communications						
Modbus RTU	■	■	■	■	■	Integrate meters to existing Modbus networks, daisy chain several (1–32) meters together
Modbus TCP	■	■	■	■	■	Easy integration with standard protocol to power management and other software
BACnet/IP	■	■	■	■	■	Easily integrate into existing building management systems without the need for external protocol adapters
HTTP, HTTPS	■	■	■	■	■	Communicate to the meter over the Internet via standard Web browser
SNMP (Simple Network Management Protocol)	■	■	■	■	■	Communicate with the meter via Simple Network Protocol; hook to existing NMS system
SMTP (Simple Mail Transfer Protocol)	■	■	■	■	■	Send e-mail messages via standard Simple Mail Transfer Protocol
NTP (Network Time Protocol)	■	■	■	■	■	Network Time Protocol support enables the meter to synchronize time over the network
DNP 3.0	■	■	■	■	■	Easy integration with serial DNP networks
Trend measurements CSV file export	■	■	■	■	■	Easily export trend measurements to third-party applications, in standard CSV file format
Logs						
Trend logging	■	■	■	■	■	Log trend information for easy statistical analysis
Load profile	■	■	■	■	■	Review the load profile graph to get a better understanding of your electrical load versus time
Event logging	■	■	■	■	■	Log events for retrospective event analysis
Memory and Storage						
Standard memory, MB	256	512	768	768	768	Store trend data and events for historical analysis
Harmonics						
Harmonic levels		40th	40th	40th	40th	Allows you to identify potential harmful harmonics
Total Harmonic Distortion (THD)		■	■	■	■	Review the total harmonic distortion level directly on the meter
Individual harmonics			■	■	■	Provides simple metric for power quality viewable from the embedded Web server
Waveform						
Waveform display			■	■	■	Waveform view on a PC, through an embedded Web server, to visualize steady-state harmonic content to identify power quality issues
Waveform recording				64	512	Ability to record waveforms up to specified samples/cycle
I/O						
I/O Two relay outputs/two status inputs Four KYZ pulses/four status inputs Four analog outputs 0–1 mA Four analog outputs 4–20 mA	Opt	Opt	Opt	Opt	Opt	The Power Xpert Meter 2000 I/O Cards are extremely flexible and can be used in a large variety of different applications. Digital inputs and relay outputs can be programmed to interact during various conditions defined by the user. Various third-party devices, such as alarms, pulse meters, trip units and sensors, can be easily integrated to the Power Xpert Meter 2000. Triggers and events can be tied to the meter's standard functions such as e-mail, logs and trends. Analog outputs can be programmed to output meter parameters to BMS or PLC systems.

* These specifications are subject to change without notice and represent the maximum capabilities of the product with all options installed. This is not a complete feature list. Features and functionality may vary depending on selected options, firmware version and product model. Please refer to the technical data sheet and the user manual for detailed specifications.

Power Xpert Meter 2000

A world of difference in power quality analysis

Identify problems before they occur

Harmonics, voltage fluctuations, overvoltage conditions and other power anomalies can wreak havoc on your equipment and processes. It is essential to fully understand the quality of the power that is being delivered throughout the facility. Detailed event information makes it possible to pinpoint the root causes of problems—or to help prevent them from occurring.

Built-in graphing

Power Xpert Meter 2000 Series redefines the art of measuring and monitoring power quality. Thanks to the latest technologies, these metering instruments are able to measure, trend, analyze and capture waveforms while serving Web pages to users over the Internet, along with simultaneous comma separated values (CSV) exporting capabilities. No matter if you are a PhD level power quality engineer or an IT system administrator, these instruments will provide you with the level of information you need, in an easy-to-understand graphical user interface.

Easy-to-use interface—demystifies power quality

In designing these power quality instruments, Eaton set out to demystify power quality—to take highly specialized data and convert it into useful information that doesn't require a power guru or a consultant to understand. The result is an uncommonly easy-to-use interface and a new graphical analysis of complex power quality data—delivered via e-mail, over the Web and to third-party applications. With these capabilities, your power team can predict and prevent power quality problems before they lead to equipment malfunction, overheated circuits and system failure.

Up to 768 MB of storage capability—store and trend years' worth of data

Having enough storage capacity is a critical factor at this level of power quality instrumentation. How long can I store data locally on the power quality meter before the system will have to start overwriting previously captured information? A Power Xpert Meter has a minimum of 256 MB, with as much as 768 MB, of storage. In a typical power quality environment, this would provide storage capability from 5 to 15 years, depending on the meter model.

Power Xpert Meter 2000 estimated memory and storage capacity with up to 768 MB

Model	5-Minute Interval Trends	15-Minute Interval Trends	60-Minute Interval Trends	Alarms and Events	Total Storage (Approx.)
PXM 2250	90 days	1 year	5 years	100,000	256 MB
PXM 2260	180 days	2 years	10 years	100,000	512 MB
PXM 2270/2280/2290	1 year	3 years	15 years	100,000 ¹	768 MB

¹ PXM 2280/2290 includes 1500 waveforms.



Power Xpert Meter 2000

Access the meter from any location via embedded Web server

The Power Xpert Meter 2000 offers Eaton customers a new level of accessibility to the critical information required to manage the electrical distribution system. The meter's embedded Web server includes real-time circuit information in both numeric and graphical visual formats to help monitor circuit parameters, such as current loading, voltage and power levels, and power factor.

Power Xpert Meter 2000 home page

The Web server also provides the energy and demand readings required to help manage the cost of energy. Readings include kWh, kVARh, delivered and received, and kVAh. The Web server on the Power Xpert Meters also includes critical information regarding power quality, such as harmonic distortion, and more.

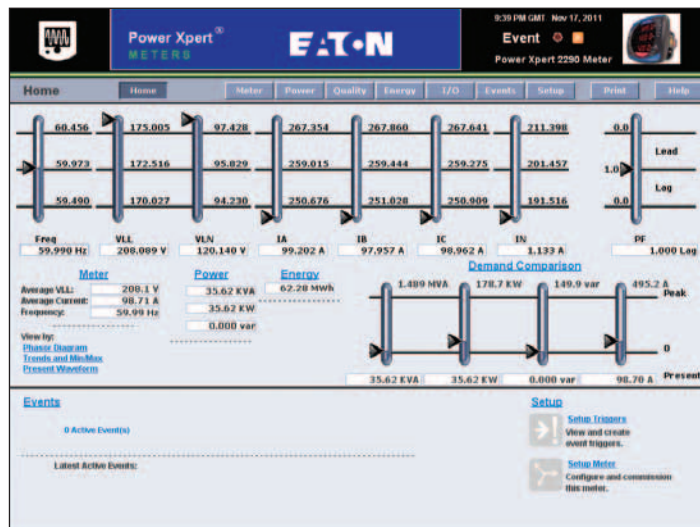

Disturbance recording sag/swell recording

The Power Xpert Meter 2280/2290 offers maximum flexibility in waveform recording by allowing the number of recorded waveform cycles, number of pre- and post-event cycles, and sampling rate to be configured to your system requirements. The Power Xpert Meters 2280/2290's embedded Web server supports viewing of triggered waveforms one channel at a time, including the ability to zoom and to scroll horizontally using a slider bar. Waveforms are stored in the meter's non-volatile flash memory using an industry standard COMTRADE format and can be retrieved from an FTP directory structure.

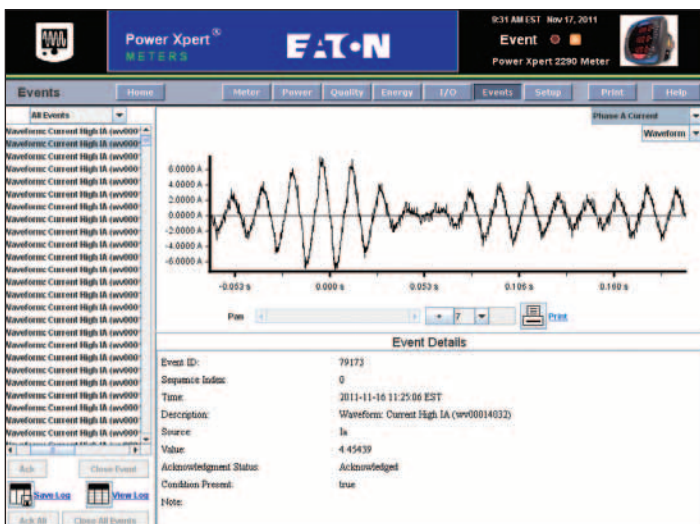

Historical trend plot

The Power Xpert Meter 2000 embedded Web server supports graphical trend charts of key circuit measurements, such as current, voltage, power and energy. The trend chart supports a zoom feature that allows the user to view data over a short period of 16 hours or a longer period of 48 months. The trend chart has a horizontal slider bar control to manage scrolling forward and backward through the data. Trend charts of basic readings include minimum, maximum and average readings. Trend charts of energy data also display demand values.

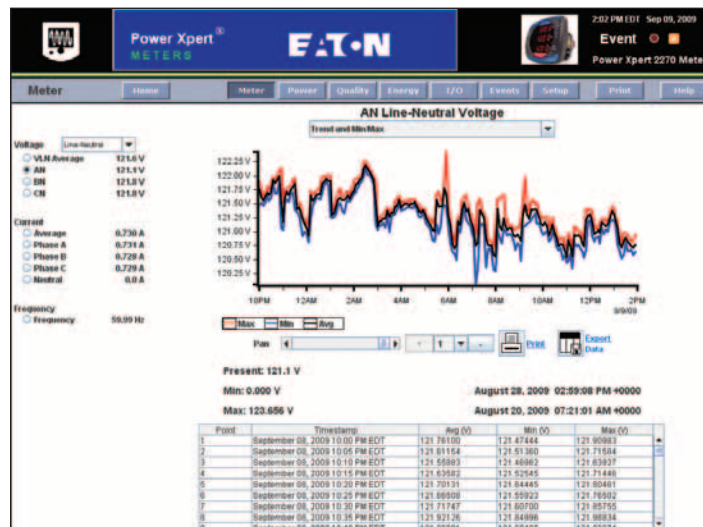

FTP waveform directory

Waveform captures are automatically stored on the FTP server in the IEEE® standard COMTRADE file format. This allows users to view and analyze the waveforms in any standard free-of-charge or commercial COMTRADE file viewer.

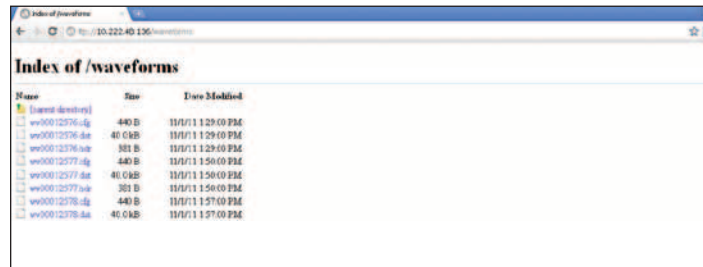

Power Xpert Meter 2000

Access the meter from any location via embedded Web server, continued

Harmonic spectral plot

The harmonic spectral plot displays harmonics up to the 40th order. A detailed table also includes individual magnitudes and angles of current and voltage harmonics at each frequency. Individual and total THD are displayed for diagnostic purposes.

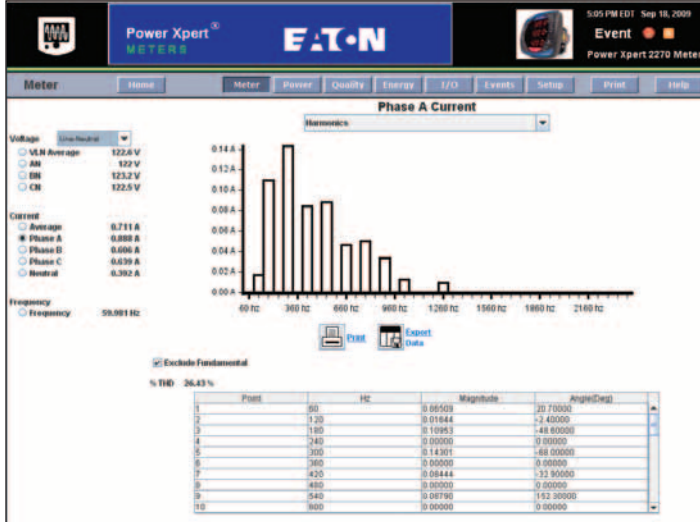

Energy demand comparison screen

Energy demand patterns can be effortlessly analyzed with the month-to-month, week-to-week comparison chart. Raw data can be easily exported with the "Save Table" option to other applications such as Excel for further analysis or graphing.

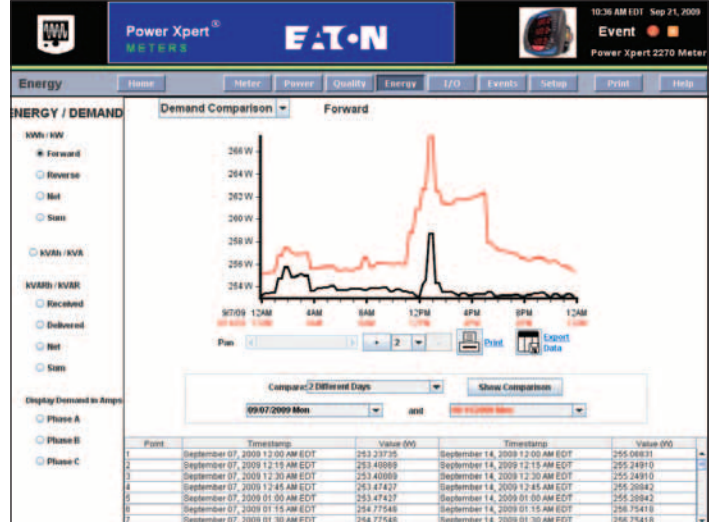

Modbus RTU (RS-485) – non-Web enabled

A Modbus RTU Master is supported where Power Xpert Meters are set up as Modbus slaves. This configuration is a cost-efficient way to connect to an existing Modbus RTU Master, e.g., a building management system (BMS).

Web enabled – browser and Modbus TCP

Web browsing and Modbus TCP Master connectivity are also available in this configuration example. All Power Xpert Meters have an Ethernet connection.

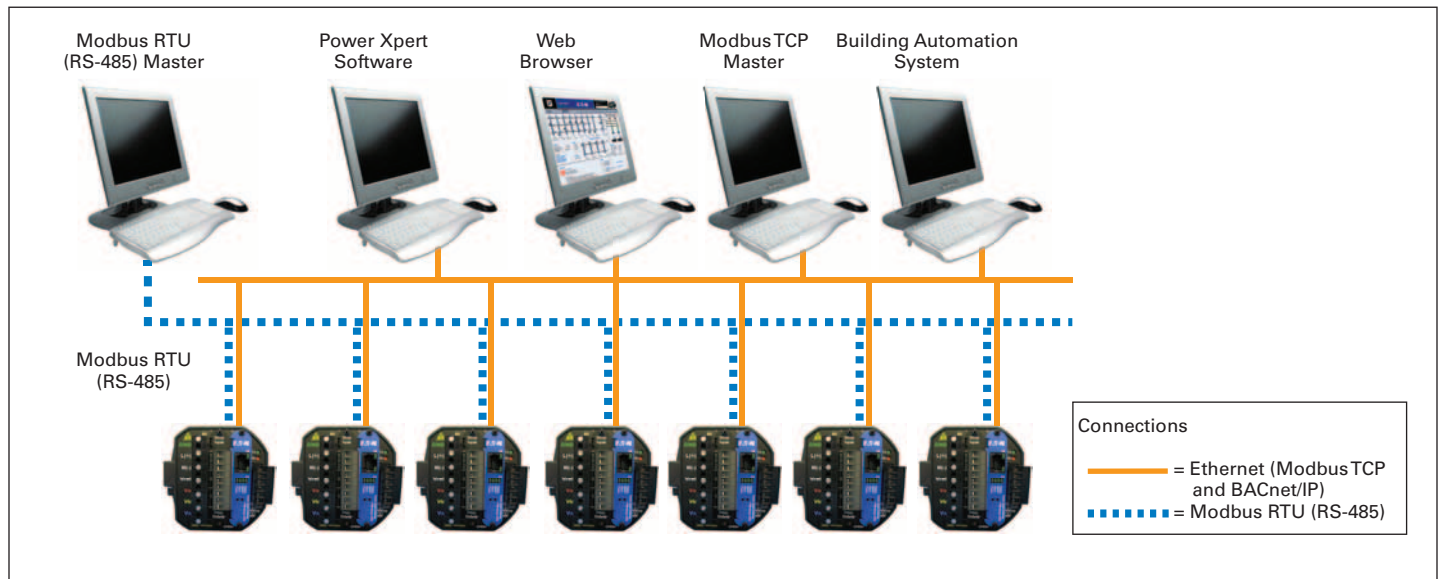

Web Enabled—Advanced System Functionality

Power Xpert Meter 2000

Inputs and outputs

The Power Xpert Meter 2000 is available with a standard KYZ output and optional I/O Cards, which include:

- Two relay outputs/two status inputs
- Four KYZ pulses/four status inputs
- Four analog outputs 0–1 mA
- Four analog outputs 4–20 mA

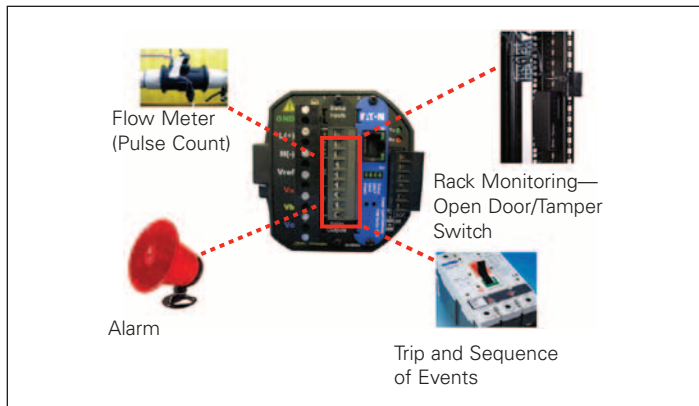

Accessories—I/O Cards (option)

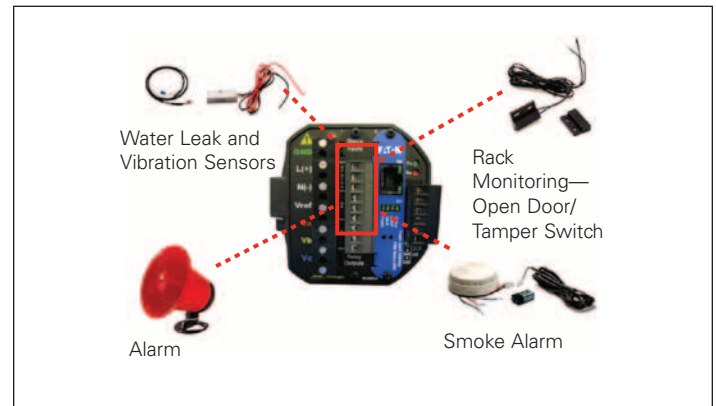

IT Configuration Examples—Accessories—I/O Cards (option)

Available accessories

Power Xpert Meter 2000 Gateway Card Kit

The Power Xpert Meter 2000 Gateway Card kit is used to convert an IQ 250/260 to a Power Xpert Meter 2000. It supports remote communications with the onboard Web server application over your LAN/WAN, via standard Ethernet 10/100Base-T connection. It also provides data logging capability.

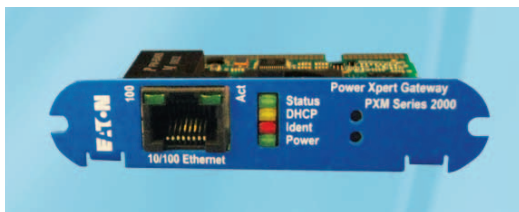

Power Xpert Meter 2000 Gateway Card

Mounting options

- Panel mounting IQ cutout adapter flange for retrofitting a PXM 2000 to an IQ Analyzer/IQ DP-4000/IQ Data/IQ 300 cutout (IQ250-PMMAK)

I/O Cards

The Power Xpert I/O Cards are extremely flexible and can be used in a large variety of different applications. Digital inputs and relay outputs can be programmed to interact during various conditions defined by the user. Various third-party devices, such as alarm, pulse meters, trip units and sensors, can be easily integrated to the Power Xpert Meter. Triggers and events can be easily tied into the meter's standard functions, such as e-mail, logs and trends. Analog outputs can be programmed to emulate any measured meter parameter for output to other remote monitoring systems.

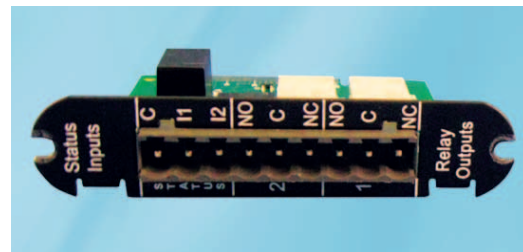

I/O Cards

Power Xpert Meter 2000 Catalog Numbering System

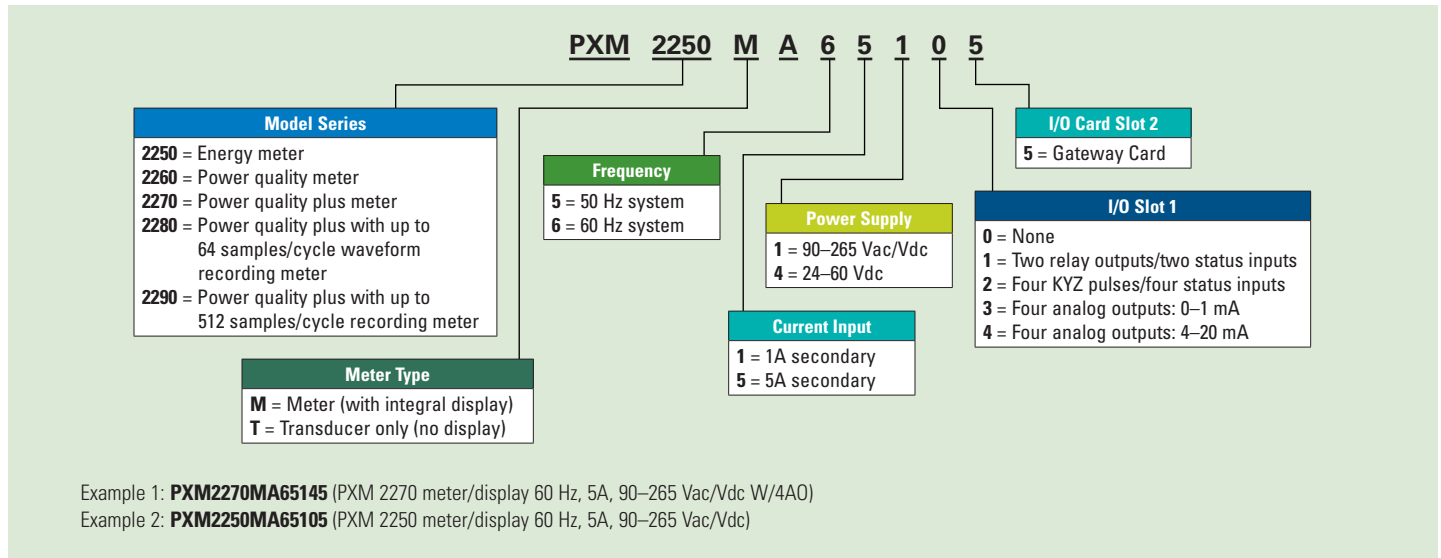

Power Xpert Meter 2000 Accessories

Description	Catalog Number
Panel-mounting bracket assembly for retrofitting a PXM 2000 to an IQ Analyzer/IQ DP-4000/IQ data cutout	IQ250-PMAK
PXM 2000 Gateway Card kit to upgrade an IQ 250/260 to a PXM 2000	PXM2000-GCK
PXM 2000 I/O Card—two relay outputs/two status inputs	IQ250/260-I01
PXM 2000 I/O Card—four KYZ pulses/four status inputs	IQ250/260-I02
PXM 2000 I/O Card—four analog outputs—0–1 mA	IQ250/260-I03
PXM 2000 I/O Card—four analog outputs—4–20 mA	IQ250/260-I04

To find out more about how Power Xpert Meters can improve power performance for your critical systems, visit our Web site at www.eaton.com/meters or contact us at 1-877-ETN-CARE (1-877-386-2273).

Eaton Corporation
 Electrical Sector
 1111 Superior Ave.
 Cleveland, OH 44114
 United States
 877-ETN-CARE (877-386-2273)
Eaton.com/meters

© 2012 Eaton Corporation
 All Rights Reserved
 Printed in USA
 Publication No. BR02601007E / Z11701
 January 2012

EATON
 Powering Business Worldwide

Eaton and Power Xpert are registered trademarks of Eaton Corporation.

All other trademarks are property of their respective owners.