

Panelboards

Contents

Panelboards

Overview

Market and Segment Applications	22.0-2
Standards and Certifications	22.0-2
Available Ratings	22.0-2
Panelboard Options	22.0-2
Panelboard Selection Guide	22.0-5
General Construction Features	22.0-5
Application Considerations	22.0-6
Technical Data	22.0-9
Series Ratings	22.0-12

Pow-R-Line® 1a	22.1-1
---------------------------------	---------------

Pow-R-Line 2a	22.2-1
--------------------------------	---------------

Pow-R-Line 3a	22.3-1
--------------------------------	---------------

Pow-R-Line 3E	22.3-5
--------------------------------	---------------

Pow-R-Line 4	22.4-1
-------------------------------	---------------

Pow-R-Line Column Type

Pow-R-Line 1a-LX Column Type	22.5-1
--	--------

Pow-R-Line 2a-LX Column Type	22.5-4
--	--------

Retrofit Panelboards

Pow-R-Line 1R Retrofit Panelboard	22.6-1
---	--------

Pow-R-Line 2R Retrofit Panelboard	22.6-3
---	--------

Pow-R-Line 1aF	22.6-5
---------------------------------	---------------

Pow-R-Line 2aF	22.6-7
---------------------------------	---------------

Pow-R-Line 3FQS	22.6-9
----------------------------------	---------------

Elevator Control Panelboard	22.6-11
--	----------------

Panelboard Modifications	22.6-12
---	----------------

Specifications

See Eaton's *Product Specification Guide*, available on CD or on the Web.

CSI Format:	1995	2010
	Section 16470	Section 26 24 16

Overview

Choices to quickly change feeder breakers in electrical distribution equipment have evolved over the years. While using drawout switchgear with power air circuit breakers remains a highly reliable solution, requests for drawout molded-case circuit breakers (MCCBs) have increased. And, customers need a wall-mounted panelboard solution with front accessibility and front-connected equipment to meet space requirements and application needs.

Eaton's drawout MCCB Pow-R-Line® 4D (PRL4D) panelboard provides this solution.

This is the first design to offer two- and three-pole MCCBs in a mechanical drawout design. Breaker ratings from 20 A to 600 A use unique drawout cassettes. Breakers are inserted and removed via a mechanical removal system similar to other drawout designs associated with switchgear; however, these breakers are horizontally mounted in a traditional panelboard group-mounted manner.

Market and Segment Applications

While the drawout MCCB panelboard design may be substituted for nearly any traditional application with feeder MCCBs, it has been specifically designed to meet the needs of several industries, including:

- Electrical distribution systems where a changeout of circuit breakers is needed to upgrade equipment to a new process
- Data centers
- Industrial facilities to minimize downtime
- Institutions
- Laboratories
- Health care facilities
- Critical load applications

Standards and Certifications

- UL® 67 Listed for wall-mounted applications from 600 A to 1200 A
- National Electrical Code®

Available Ratings

The panelboards are rated at 240 Vac, 480 Vac and 600 Vac. Fault current is available up to 200 kAIC at 240 Vac, 100 kAIC at 480 Vac and 65 kAIC at 600 Vac. The short-circuit current rating of the panelboard is determined by the low short-circuit current rating of the lowest rated overcurrent device in the panelboard.

Boxes and trims are UL 50 Listed and labeled. Both the box and the trim are painted ANSI-61 light gray. Deadfront covers are also painted ANSI-61 light gray to match box and trim.

Drawout feeder MCCBs are available in two- and three-pole offerings from 20 A to 600 A. Main breakers above 600 A are fixed-mounted using a traditional bolt-on design. Main breakers 600 A and below are available with either the traditional fixed-mounted, bolt-on design or in a drawout cassette. For drawout mains or feeders above 600 A, please use Eaton's switchboard offering.

Panelboard Options

- Copper and silver-plated copper
- Copper lugs
- Density-rated bus
- Ground bars
- Customer-owned meters
- Service equipment construction
- Surge protective devices
- Seismically qualified panelboards

Pow-R-Line 1a, 2a and 3a, and 3E

- Robust design using Eaton circuit breakers
- Increased ratings (with Series Rated main circuit breakers) provide higher short-circuit ratings
- Pow-R-Line 3a can accommodate branch breakers dual-mounted through 150 A and single-mounted through 225 A
- Pow-R-Line 3E panelboards accommodate branch-mounted breakers up to 125 A
- Lock and Door opening mechanism includes a positive slide catch and right- or left-hand installation
- Surface or flush trims
- UL tested and listed. Meets NEC® and NEMA® standards

Special Use Pow-R-Line Panelboards

- Pow-R-Line 1a-LX and Pow-R-Line 2a-LX column panelboards are designed to fit within the structural I-beam of a facility and offer branch circuits up to 100 A
- Pow-R-Line 1aF and Pow-R-Line 2aF fusible lighting panelboards were developed for ultra high fault currents and for use in selective coordination applications and test circuits
- Pow-R-Line 1R and Pow-R-Line 2R Retrofit Panelboards are the only panelboards in the market listed for use in retrofit applications in other manufacturers' existing back boxes
- Elevator control panelboards integrate electrical protection and controls for elevators and meet stringent code requirements in a single, cost-effective package

Pow-R-Line 4B and 4F Power Panels

- Pow-R-Line 4B panelboard uses circuit breakers
- Pow-R-Line 4F panelboard uses fusible switches
- A single chassis accommodates both circuit breakers and fusible switches
- Main and neutral are located at the same ends to provide additional space for branch devices
- Three-piece trim facilitates installation
- Will accommodate circuit breakers to provide higher ratings in a standard chassis and increased series ratings
- UL tested and approved. Meets NEC and NEMA standards

Pow-R-Line 4D Drawout Panelboard

- Quick change-out or addition of breakers without changing hardware
- Front connected, front accessible
- Drawout circuit breakers 20–600 A ratings
- Fixed-mounted molded-case circuit breakers 15–1200 A
- Mains 400–1200 A
 - Main lugs only
 - Main molded-case circuit breaker
- Single chassis supports both drawout and fixed-mounted breakers
- Mains and neutrals mounted on same end of chassis/box

Product Selection

Table 22.0-1. Product Types

Type PRL1a	Fusible Lighting Panelboard PRL1aF	Type PRL1a-LX Column Type	Type PRL2a	Fusible Lighting Panelboard PRL2aF	Type PRL2a-LX Column Type
Bolt-on or plug-on circuit breakers 240 Vac maximum	240 Vac maximum	Bolt-on circuit breakers 240 Vac maximum	Bolt-on or plug-on circuit breakers 240 or 480Y/277 Vac 125/250 Vdc maximum	240 and 480Y/277 Vac maximum	Bolt-on or plug-on circuit breakers 240 or 480Y/277 Vac 125/250 Vdc maximum
Main lugs only 600 A maximum	Main lugs only 400 A maximum	Main lugs only 225 A maximum	Main lugs only 600 A maximum	Main lugs only 400 A maximum	Main lugs only 225 A maximum
Main circuit breaker 600 A maximum		Main circuit breaker 225 A maximum	Main circuit breaker 600 A maximum		Main circuit breaker 225 A maximum
Branch circuit breakers 100 A maximum Single, two- and three-pole	Branch overcurrent protective devices 30 A maximum, Single-, two- and three-pole utilizing Class CC fuses	Branch circuit breakers 100 A maximum Single-, two- and three-pole	Branch circuit breakers 100 A maximum Single-, two- and three-pole	Branch overcurrent protective devices 30 A maximum, Single-, two- and three-pole utilizing Class CC fuses	Branch circuit breakers 100 A maximum Single-, two-, and three-pole

General Description—Pow-R-Line

22

Table 22.0-1. Product Types (Continued)





				
Retrofit Panelboard PRL-1R and PRL-2R	Type PRL3a	Type PRL3E	Type PRL4	Type PRL5P
Bolt-on or plug-on circuit breakers 240 or 480Y/277 Vac	Bolt-on circuit breakers 240, 480 or 600 Vac; 250 Vdc maximum	Bolt-on circuit breakers 240 Vac maximum	Circuit breakers or fusible switches; 240, 480 or 600 Vac; 600 Vdc maximum	Plug-on circuit breakers 240, 480 or 600 Vac; 250 Vdc maximum
Main lugs only 225 A maximum	Main lugs only 800 A maximum	Main lugs only 600 A maximum	Main lugs only 1200 A maximum	Main lugs only 1200 A maximum
			Main circuit breaker 1200 A maximum	
Main circuit breaker 225 A maximum	Main circuit breaker 600 A maximum	Main circuit breaker 600 A maximum	Main fusible switch 1200 A maximum	Main circuit breaker 1200 A maximum
			Branch circuit breakers 1200 A maximum, Single-, two- and three-pole	
Branch circuit breakers 100 A maximum Single-, two- and three-pole	Branch circuit breakers 225 A maximum Single-, two- and three-pole	Branch circuit breakers 125 A maximum Single-, two- and three-pole	Branch fusible switches 1200 A maximum, Single-, two- and three-pole	Branch circuit breakers 1200 A maximum, Single-, two- and three-pole

Table 22.0-1. Product Types (Continued)

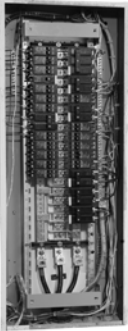

		
Pow-R-Command	Metering Service Section	Elevator Control Panelboard
Bolt-on or plug-on circuit breakers 240 or 480Y/277 Vac	Bolt-on circuit breakers 240, 480 or 600 Vac	Bolt-on fusible switches 600 Vac maximum
Main lugs only 400 A maximum	Service entrance panels combining a main disconnect with a power company metering compartment 400–1200 A	Controls for up to four elevators in a single panelboard
Main circuit breaker 400 A maximum		Main lugs only 800 A maximum
Branch circuit breakers 225 A maximum Single-, two- and three-pole		Branch overcurrent devices 15–200 A fusible switches with Class J fuse clips maximum
Single- and two-pole remote operated circuit breakers		
Integral load switching and dimming controls		Designed to meet specific sections various codes impacting elevators

Table 22.0-2. Panelboard Selection Guide

Panelboard Type	Page Reference	Device Type	Maximum Voltage Rating		Maximum Main Rating, Amperes		Branch Circuits Ampere Range	Short-Circuit Current Ratings rms Symmetrical Amperes, AC	
			AC	DC	Main Lugs Only	Main Device		Fully Rated (kA)	Series Rated (kA)
Pow-R-Line 1a ①	22.1-1	Breaker	240	—	600	600	15–100	10–22	22–200
Pow-R-Line 2a ①	22.2-1	Breaker	240 480Y/277	250	600 400 ②	600 400 ②	15–100 15–100	65 14	65–200 22–150
Pow-R-Line 3a ①	22.3-1	Breaker	240 480 600	250	800 800 800	600 600 600	15–225 15–225 15–225	10–200 14–100 14–35	22–200 22–150 —
Pow-R-Line 3E ①	22.3-5	Breaker	480	250	600	600	15–125	35–65	35–100
Pow-R-Line 4B ①	22.4-1	Breaker	240 480 600	600	1200 1200 1200	1200 1200 1200	15–1200 15–1200 15–1200	10–200 14–200 14–200	22–200 22–150 —
Pow-R-Line 4F ①	22.4-8	Fusible switch	240 600	250	1200 1200	1200 1200	30–1200 30–1200	100–200 100–200	— —
Pow-R-Line 4D	22.4-11	Breaker	240 480	—	1200 1200	1200 1200	20–600 Drawout 15–1200 Fixed	100 65	— —
Pow-R-Line 1aF	22.6-5	Fusible switch	240	—	400	400	15–30	200	200
Pow-R-Line 2aF	22.6-7	Fusible switch	480Y/277	—	400	400	15–30	200	200
Pow-R-Line 1a-LX	22.5-1	Breaker	240	—	225	225	15–30	10–22	18–200
Pow-R-Line 2a-LX	22.5-4	Breaker	480Y/277	125/250	225	225	15–30	14	25–150
Pow-R-Line 1R	22.6-1	Breaker	240	—	225	225	15–100	10–22	22–100
Pow-R-Line 2R	22.6-3	Breaker	480Y/277	—	225	225	15–100	14	22–150
Elevator control panelboard ①	22.6-11	Fusible	480	—	800	800	15–200	10–200	14–100

① Available with surge protective device (SPD) and metering.

② Amperage rating for dc voltage.

General Construction Features

Eaton’s assembled panelboards are designed for sequence phase connection of branch circuit devices. This allows complete flexibility of circuit arrangement (single-, two- or three-poles) to allow balance of the electrical load on each phase.

Sturdy, rigid chassis assembly ensures accurate alignment of interior with panel front; prevents flexing and minimizes possibility of loosening or damage to current carrying parts during and after installation.

Four point in-and-out adjustment of panel interior is provided to meet critical depth dimensions on flush installations. This compensates for possible misalignment of box at installation.

Main lugs are mechanical solderless type and approved for copper and aluminum conductors.

Enclosures

Boxes are code-gauge galvanized steel except for column type panelboards, which include a painted box finished in ANSI-61 light gray to match the trim.

Standard panelboard cabinets are designed for indoor use. Alternate types are available for outdoor and special purpose applications.

All enclosures are furnished in accordance with UL standards and include wiring gutters with proper wire bending space. Special cabinets can be provided at an additional charge.

The box dimensions shown are inside dimensions. For outside dimensions, add 0.25-inch (6.4 mm).

Standard panelboard boxes are supplied without knockouts (blank endwalls).

EZ™ Trim

The EZ box and EZ trim are provided standard for Pow-R-Line 1a and Pow-R-Line 2a lighting panelboards, as well as Pow-R-Line 3a and Pow-R-Line 3E mid-range panelboards.



EZ Trim Provides Standard Door-in-Door Construction With No Exposed Hardware or Sharp Ridges. No Tools are Required for Installation.

The trims for lighting and appliance branch circuit panelboards and small power distribution panelboards include a door with rounded corners and concealed hinges. A flush-type latch and lock assembly is included. All locks are keyed alike. These trims are available in both surface and flush mounted designs.

Fronts for power distribution panelboards use a unique breaker front cover design in which each device has a dedicated bolt-on steel cover. The individual covers form a single dead-front for the panelboard that is used in conjunction with two wiring gutter covers to complete the trim. A door is not finished as part of the standard offering on these panelboards but can be provided, for an additional charge, using a deeper than standard box.

Combination AFCI Circuit Breakers

Eaton’s 125 Vac AFCI single- and two-pole, 15 A and 20 A bolt-on breakers in panelboards meet Article 210.12 of the NEC. See the NEC code for definitions and details.

Application Considerations

Standards

All Eaton's panelboards are designed to meet the following applicable industry standards, except where noted:

1. Underwriters Laboratories
 - a. Panelboards: UL 67
 - b. Cabinets, boxes and trims: UL 50

Note: Only panelboards containing UL listed devices can be UL labeled.

2. National Electrical Code
3. NEMA Standards: PB 1
4. Federal Specification W-P-115c
Circuit breaker—Type I Class 1
Fusible switch—Type II Class 1

Panelboard Selection Factors

In selecting a panelboard, the following factors must be considered:

- a. Service (voltage and frequency).
- b. Interrupting capacity (fully or series rated).
- c. Ampere rating of main.
- d. Ampere ratings of branches.
- e. Installation environment.
- f. Codes and standards mandates.

Panelboard Short-Circuit Rating

The short-circuit rating of Eaton's assembled panelboards are test verified by, and listed with, Underwriters Laboratories. Generally, these ratings are that of the lowest interrupting rated device in the panel.

Certain exceptions to this rule exist where branch devices have been UL tested in combination with specific main devices having a higher interrupting rating. Where these defined main breaker and branch breaker combinations are used, the **series short-circuit rating** of the assembled panelboard will be the same as the series tested rating of the approved rated main breaker. Available main and branch breaker combinations are tabulated on **Page 22.0-12** through **Page 22.0-22**. All combinations shown are UL tested and listed.

These series ratings apply to panels having main devices, or main lug only panelboards fed remotely by the device listed in the series ratings chart as the main, for which UL listed tests were conducted.

Selective Coordination

Please refer to Molded-Case Circuit Breakers, **Tab 27**, for detailed information on overcurrent protective device combinations for use on selectively coordinated systems.

Service Entrance Equipment

NEC Articles 230.F and G, and UL, require that:

- a. Panels used as service entrance equipment must be located near the point where the supply conductors enter the building.
- b. A panelboard having main lugs only shall have a maximum of six service disconnects to de-energize the entire panelboard from the supply conductors. Where more than six disconnects are required, a main service disconnect must be provided.
- c. Must include connector for bonding and grounding neutral conductor.
- d. A service-entrance-type UL label must be factory installed.
- e. Ground fault protection of equipment shall be provided for solidly grounded wye electrical services of more than 150 V to ground, but not exceeding 600 V phase-to-phase for each service disconnecting means rated 1000 A or more.

Service entrance panels must be identified as such on the order entry to the manufacturing location.

Column Type Panelboards

The same general code restrictions apply as for standard width panels except where trough extensions are used.

Multi-Section Panelboards

When more than 42 overcurrent protective devices are required, two or more separate enclosures may be required. Separate fronts for each box are standard.

Interconnecting Multi-Section Panelboards

When a panelboard, for connection to one feeder, must be furnished in more than one section (box), each section must be furnished with main bus and terminals of the same rating, unless a main overcurrent device is provided in each section.

Sub-feed or through-feed provisions must also be added to provide connection capability to the second section.

Note: Sub-feed or through-feed lugs cannot be used on any panelboard that is not protected by a single main overcurrent device either in the panelboard or immediately upstream, i.e., service entrance panelboards with main lugs only using the six disconnect rule.

Sub-Feed Lugs (Figure 22.0-1)

Sub-feed lugs are one means of interconnecting multi-section panels. The sub-feed (second set of) lugs are mounted directly beside the main lugs. These are required in each section except the last panel in the lineup. The feeder cables are brought into the wiring gutter of the first section and connected to the main lugs. Another set of the same size cables are connected to the sub-feed lugs (Section 1) and are carried over to the main lugs of the adjacent panel. Cross connection cables are not furnished by Eaton. Sub-feed lugs are only available on main lug only panels.

Note: Sub-feed lugs may not be used on main lug only (six disconnect rule) service entrance panels.

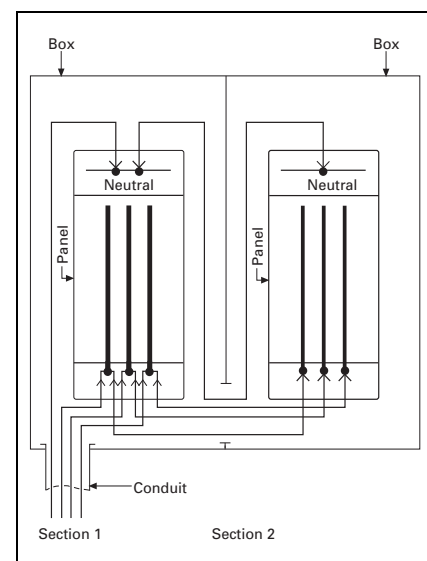

Figure 22.0-1. Sub-Feed Lugs

**Application Considerations
(Continued)**

Through-Feed Lugs (Figure 22.0-2)

Through-feed lugs are another method to interconnect multi-section panelboards. The incoming feeder cables are connected to the main lugs or main breaker at the bottom of panel (Section 1). Another set of lugs (through-feed) are located at the opposite end of the main bus. The interconnecting cables are connected to the through-feed lugs in Section 1 and are carried over to the main lugs in Section 2. The connection arrangement could be reversed, i.e., main lugs at top; through-feed lugs at bottom end of panel. Cross cables are not furnished by Eaton.

Note: Through-feed lugs may not be used on main lug only (six disconnect rule) service entrance panels.

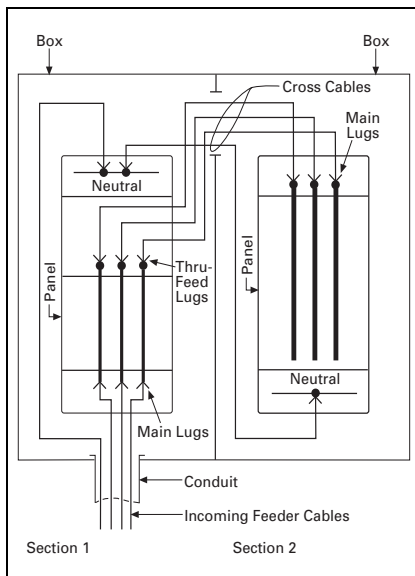
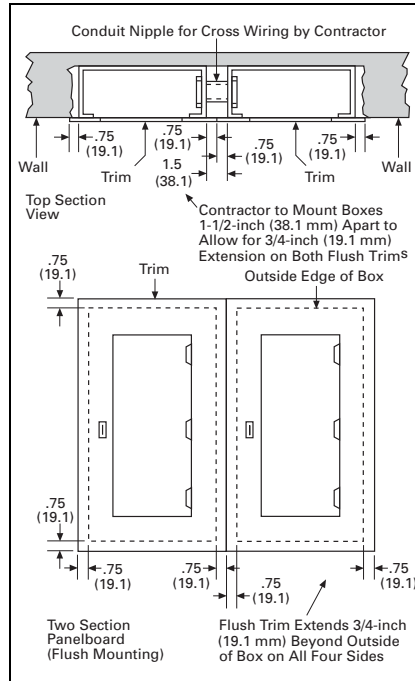

Figure 22.0-2. Through-Feed Lugs

**Multiple Section Panelboard—
Flush Mounted**

Shown below is the standard method for flush mounting multiple section lighting and distribution panelboards using standard flush trims.



**Figure 22.0-3. Multiple Section Panelboard—
Flush Mounted—Dimensions in Inches (mm)**

Branch Circuit Loading for Lighting Panels

The size of mains and branches should be selected based on the following:

- a. Lighting circuits: NEC Article 210, 215, 220 and 240.
- b. Distribution circuits, actual or continuous loads: NEC Article 384.16.
- c. Motor circuits: NEC Article 430.
- d. Diversity factor.
- e. Provision for future loading.

Overcurrent Protection

National Electrical Code Article 408 states a panelboard shall be protected by an overcurrent protective device having a rating not greater than that of the panelboard. The overcurrent protective device shall be located within or at any point on the supply side of the panelboard.

Exceptions to Article 408 selectively apply. Refer to the National Electrical Code Article 408 for specifics.

Ground Fault Protection

Ground fault protection (GFP) may be added to most panelboards using Eaton’s integral molded-case circuit breaker GFP and included feeder devices on power panelboards and mains on all panelboards.

Arcflash Reduction Maintenance System™

Eaton’s Arcflash Reduction Maintenance System is available on many molded-case circuit breakers from 70 A to air power circuit breakers at 5000 A. Recognized by the 2011 National Electrical Code and the National Electrical Safety Code (NFPA 70E), the Arcflash Reduction Maintenance System allows breakers to trip quickly thus significantly reducing the available arc flash potential.

Ambient Temperatures

The primary function of an overcurrent device is to protect the conductor and its insulation against overheating. In selecting the size of the devices and conductors, consideration should be given to the ambient temperature surrounding the conductors within and external to the panelboard. Cumulative heating within the panelboard may cause premature operation of the overcurrent protective devices.

UL test procedures are based, in part, on 80% loading of panelboard branch circuit devices. Article 408 of the NEC limits the loading of overcurrent devices in panelboards to 80% of rating where in normal operation the load will continue for three hours or more.

Further derating may be required, depending on such factors as ambient temperature, duty cycle, frequency or altitude.

Exception: There is one exception to this rule in both UL and NEC. It applies to assemblies and overcurrent devices that have been approved for continuous duty at 100% of its rating. This exception is covered in NEC 210.20 (a). Also see **Tab 27** of this application guide for additional information.

Application Considerations (Continued)

Special Conditions

Standard panelboards, assembled with standard components, are adequate for most applications. However, special consideration should be given to those required for application under special conditions such as:

- Excessive vibration or shock.
- Frequencies above 60 cycles.
- Altitudes above 6600 ft (2012 m).
- Damp environment (possible fungus growth).
- Compliance with federal, state and municipal electrical codes and standards.

Seismic Qualification



Refer to **Tab 1** for information on seismic qualification for this and other Eaton products.

Harmonic Currents

Standard panelboard neutrals are rated for 100% of the panelboard current. However, because harmonic currents can cause overheated neutrals, an option is provided for neutrals to be rated at 200% (1200 A maximum neutral for 600 A main bus) of the panelboard phase current. Panelboards with the 200% rated neutral are UL listed as suitable for use with nonlinear loads.

Prior to specifying the 200% rated neutral, Eaton recommends a harmonic survey be conducted of the distribution system, be it new or existing.

Surge Protective Devices (SPD)

The quality of power feeding sensitive electronic loads is critical to the reliable operation of any facility. In modern offices, hospitals and manufacturing facilities, the most frequent causes of microprocessor-based equipment downtime and damage are voltage transients and electrical noise.

Electrical loads and microprocessor-based equipment are highly susceptible to both high and low energy transients. High energy transients include lightning induced surges and power company switching. These high energy transients can destroy components instantly.

More frequently the electrical system experiences low energy transients and high frequency noise.

The effects of continual low energy transients and high frequency noise can cause erratic equipment performance or sudden failure of electronic circuit board components.

Eaton can provide protective and diagnostic systems integral to panelboards. The SPD is integrated into the panelboards using a “zero lead length” direct busbar connection. Integral disconnect is used on all Pow-R-Line 4 panels.



Eaton SPDs May be Integrated into Most Panelboards

The SPD protects sensitive electronic equipment from the damaging effects of high and low energy transients.

For complete product description and available ratings, refer to **Tab 34**.

Compact Panelboard Meter

Most Eaton panelboards can integrate a compact meter for reading the panelboard power and energy usage. Eaton’s IQ 35M has ANSI 12.20 0.5% accuracy, a bright backlit LCD display, real energy pulse output, phase loss alarm and optional RS-485 communication capability.



Closeup of IQM 35 With Deadfront

Technical Data and Specifications

Table 22.0-3. Electrical Characteristics of Circuit Breakers

Circuit Breaker Ratings				UL Listed Interrupting Ratings (kA rms Symmetrical)						
Type	Ampere Rating	Number of Poles	Volts AC	AC Rating, Volts					DC Rating, Volts ^①	
				120/240	240	277	480	600	125	250
BAB, HQP	15-70 15-100	1 2	120 120/240	10 10	— —	— —	— —	— —	— —	— —
BAB-H, HQP-H	15-100	2, 3	240	—	10	—	—	—	—	—
BABRP, BABRSP	15-30 15-30	1 2	120 120/240	10 10	— —	— —	— —	— —	— —	— —
QBGf, QPGf, QPGFEP QBGFEP	15-50 15-50	1 2	120 120/240	10 10	— —	— —	— —	— —	— —	— —
QBAF, QBAG	15-20 15-20	1 2	120 120/240	10 10	— —	— —	— —	— —	— —	— —
QBHW, QPHW	15-70 15-100	1 2	120 120/240	22 22	— —	— —	— —	— —	— —	— —
QBHW-H, QPHW-H	15-100	2, 3	240	—	22	—	—	—	—	—
QBHGf, QPHGf, QPHGFEP QBHGFEF	15-30 15-30	1 2	120 120/240	22 22	— —	— —	— —	— —	— —	— —
QBHAF, QBHAG	15-20 15-20	1 2	120 120/240	22 22	— —	— —	— —	— —	— —	— —
GHB	15-100 ^② 15-100	1 2, 3	277 480Y/277	65 —	— 65	14 —	— 14 ^③	— —	14 —	— 14
GHQ	15-20	1	277	65	—	14	—	—	—	—
HGHB	15-30	1	277	65	—	25	—	—	—	—
GHBGFEP	15-60	1	277	—	—	14	—	—	—	—
GHQRSP	15-100 15-100	1 2	277 480Y/277	65 —	— 65	14 14	— 14 ^③	— —	— —	— —
GHBS	15-30 15-30	1 2	277 480Y/277	65 —	— 65	14 14	— 14 ^③	— —	— —	— —
EGB	15-125 15-125	1 2, 3	277 480	35 —	35 35	18 —	— 18	— —	10 —	— 10
EGS	15-125 15-125	1 2, 3	277 480	100 —	— 100	35 —	— 35	— —	35 —	— 35
EGH	15-125 15-125	1 2, 3	277 480	200 —	— 200	65 —	— 65	— —	42 —	— 42
EHD	15-100 15-100	1 2, 3	277 480	— —	— 18	14 —	— 14	— —	10 —	— 10
FDB	15-150	2, 3	600	—	18	—	14	14	—	10
FD, FDE	15-150 15-225	1 2, 3	277 600	— —	— 65	35 —	— 35	— 18	10 —	— 10
EDB	100-225	2, 3	240	—	22	—	—	—	10	—
EDS	100-225	2, 3	240	—	42	—	—	—	10	—
ED	100-225	2, 3	240	—	65	—	—	—	10	—
DK	250-400	2, 3	240	—	65	—	—	—	—	10
JD	70-250	2, 3	600	—	65	—	35	18	—	10
KD ^④ , CKD ^⑤	100-400	2, 3	600	—	65	—	35	25	—	10
LHH ^⑥	150-400	2, 3	480	—	100	—	65	35	—	42
NHH	150-350	3	600	—	100	—	65	35	—	—
LGE	250-600	3	600	—	65	—	35	18	—	22
LD ^④ , CLD ^{④⑤}	300-600	2, 3	600	—	65	—	35	25	—	22 ^⑥
MDL ^④ , CMDL ^{④⑤}	300-800	2, 3	600	—	65	—	50	25	—	22
ND ^④ , CND ^{④⑤}	400-1200	2, 3	600	—	65	—	50	25	—	—
CNGC	800, 1200			—	200	—	100	65	—	—
CNGH	800, 1200			—	100	—	65	35	—	—
CNGS	800, 1200			—	85	—	50	25	—	—
NGC	800, 1200			—	200	—	100	65	—	—
NGH	800, 1200			—	100	—	65	35	—	—
NGS	800, 1200			—	85	—	50	25	—	—

^① dc ratings apply to substantially non-inductive circuits.

^② dc rated single-pole, 15-70 A only.

^③ Rating 480Y/277 Vac maximum.

^④ Available with integral ground fault protection.

^⑤ 100% rated breaker.

^⑥ dc rating not available with Digitrip™ 310.

Table 22.0-3. Electrical Characteristics of Circuit Breakers (Continued)

Circuit Breaker Ratings				UL Listed Interrupting Ratings (kA rms Symmetrical)								
Type	Ampere Rating	Number of Poles	Voltage		AC Rating, Volts					DC Rating, Volts ^①		
			AC	DC	120/240	240	277	480	600	125	250	600
High Interrupting Capacity Circuit Breakers												
HFD, HFDE	15-150 15-225	1 2, 3	277 600	— —	— —	— 100	65 —	— 65	— 25	10 —	— 22	— —
EDH	100-225	2, 3	240	—	—	100	—	—	—	10	—	—
HJD	70-250	2, 3	600	—	—	100	—	65	25	—	22	—
HKD ^② , CHKD ^③	100-400	2, 3	600	—	—	100	—	65	35	—	22	—
LGH	250-600	3	600	—	—	100	—	65	35	—	22	—
HLD ^② , CHLD ^{②③}	300-600	2, 3	600	—	—	100	—	65	35	—	25 ^④	—
HMDL ^② , CHMDL ^{②③}	300-800	2, 3	600	—	—	100	—	65	35	—	25	—
HND ^② , CHND ^{②③}	400-1200	2, 3	600	—	—	100	—	65	35	—	—	—
Current Limiting Circuit Breakers												
FDC, FDCE	15-225	2, 3	600	—	—	200	—	100	35	—	22	—
EDC	100-225	2, 3	240	—	—	200	—	—	—	10	—	—
JDC	70-250	2, 3	600	—	—	200	—	100	35	—	22	—
KDC ^②	100-400	2, 3	600	—	—	200	—	100	65	—	22	—
LGC ^④	250-600	2, 3	600	—	—	200	—	100	50	—	42	—
LGU ^④	250-600	2, 3	600	—	—	200	—	150	65	—	50	—
LDC ^② , CLDC ^{②③}	300-600	2, 3	600	—	—	200	—	100	50	—	25 ^④	—
NDC ^② , CNDC ^{②③}	400-1200	2, 3	600	—	—	200	—	100	65	—	—	—
Current Limit-R[®] Circuit Breakers												
FCL	15-100	2, 3	480	—	—	200	—	150	—	—	—	—
LCL ^②	125-400	2, 3	480	—	—	200	—	200	—	—	—	—
TRI-PAC[®] Current Limiting Circuit Breakers												
FB-P	15-100	2, 3	600	—	—	200	—	200	200	—	③	—
LA-P	70-400	2, 3	600	—	—	200	—	200	200	—	③	—
NB-P	300-800	2, 3	600	—	—	200	—	200	200	—	③	—
Direct Current (DC) Rated Breakers												
HFDDC ^{⑤⑥}	15-150	2, 3	—	600	—	—	—	—	—	42	42	35
HJDDC ^{⑤⑦}	70-250	2, 3	—	600	—	—	—	—	—	42	42	35
HKDDC ^{⑤⑦}	100-400	2, 3	—	600	—	—	—	—	—	42	42	35
HLDDC ^{⑤⑦}	300-600	2, 3	—	600	—	—	—	—	—	42	42	35
HMDLDC ^{⑤⑦}	300-800	2, 3	—	600	—	—	—	—	—	42	42	35
NBDC ^{⑤⑦}	700-1200	2, 3	—	600	—	—	—	—	—	42	42	35

① dc ratings apply to substantially non-inductive circuits.

② Available with integral ground fault protection.

③ 100k based on NEMA test procedure.

④ dc rating not available with Digitrip 310.

⑤ For use on dc systems only.

⑥ Non-interrupting trip type.

⑦ Interrupting trip type.

Terminal Wire Ranges, Pressure-Type Al/Cu Terminals Except as Noted

Where copper-aluminum terminals are supplied on designated panelboard types, best results are obtained if a suitable joint compound is applied when aluminum conductors are used.

Table 22.0-4. Standard Main Lug Terminals

Panel Type	Wire Size Ranges for Ampere Capacity						
	100 A	225 A	250 A	400 A	600 A	800 A	1200 A
Pow-R-Line 1a, 1aF, 1R	#12-1/0	#6-300 kcmil	—	(2) #4-500 kcmil	(2) #4-500 kcmil ①	—	—
Pow-R-Line 2a, 2aF, 2R	#12-1/0	#6-300 kcmil	—	(2) #4-500 kcmil	(2) #4-500 kcmil ①	—	—
Pow-R-Line 3a	#12-1/0	—	#6-350 kcmil	(2) #4-500 kcmil	(2) #4-500 kcmil	(3) #4-500 kcmil	—
Pow-R-Line 3E	#12-1/0	—	#6-350 kcmil	(2) 4/0-500 kcmil	(2) 4/0-500 kcmil	—	—
Pow-R-Line 4	—	—	#4-500 kcmil	(2) #4-500 kcmil	(2) #4-500 kcmil	(3) #4-500 kcmil	(4) #4-500 kcmil
Pow-R-Command	#12-1/0	#6-300 kcmil	—	(2) #4-500 kcmil	—	—	—
PRL1a-LX	#12-1/0	#6-300 kcmil	—	—	—	—	—
PRL2a-LX	#12-1/0	#6-300 kcmil	—	—	—	—	—
PRCE	#12-1/0	#6-300 kcmil	—	(2) #4-500 kcmil	—	—	—
PRC100	#12-1/0	—	#6-350 kcmil	(2) #4-500 kcmil	—	—	—
PRC25	#12-1/0	#6-300 kcmil	—	(2) #4-500 kcmil	—	—	—
PRL5P	—	—	—	(1) #1/0-500 kcmil or (2) #1/0-250 kcmil	(2) #4-500 kcmil	(1) #2-500 kcmil or (2) #2-400 kcmil	(2) #4-750 kcmil
Elevator control	—	—	#4-500 kcmil	(2) #4/0-500 kcmil	(2) #4/0-500 kcmil	(3) #4/0-500 kcmil	—

① Not applicable PRL 1aF, 1R, PRL 2aF, 2R.

Note: Optional 750 kcmil mechanical screw-type terminals are available upon request. Panelboard dimensions may be affected. Refer to Eaton.

Table 22.0-5. Standard Main Breaker and Branch Breaker Terminals

Breaker Type	Ampere Rating	Wire Size Ranges
BAB, QBHW, BABRSP	15-70	#14-#4
HQP, QPHW	90-100	#8-1/0
EDB, EDS, ED	100-225	#4-4/0 or #6-300 kcmil
EDH, EDC ②	—	—
EGB, EGE, EGS, EGH	15-50 60-125	#14-3/0 AL/CU #6-3/0 AL/CU
EHD, FDB, FD	15-100	#14-1/0
HFD, FDC ②, HFDDC ③	125-225	#4-4/0
FCL	15-100	#14-1/0
GHB, HGHB, GHQ, GHQRSP	15-50 25-100	#14-1/0 #10-1/0
JD, HJD, JDC ②, HJDDC ③	70-250	#4-350 kcmil
DK	250-350 400	250-500 kcmil (2) 3/0-250 kcmil or (1) 3/0-500 kcmil
KD HKD, KDC, HKDDC ③ CKD ②, CHKD ②	225 350 400	(1) #3-350 kcmil (2) 3/0-250 kcmil or (2) 3/0-250 kcmil or (1) 3/0-500 kcmil
LHH	150-400	#2-500 kcmil (2) #2-500 kcmil or (1) 500-750 kcmil
LGE, LGH, LGC	250-400 500-600	(1) #2-500 kcmil (2) #2-500 kcmil
LD, HLD, LDC, CLD ② HLDDC ③, CHLD ②	300-500 600	(2) 250-350 kcmil (2) 400-500 kcmil
MDL, HMDL, HMDLDC ② CMDL, CHMDL	400-600 700-800	(2) #1-500 kcmil (3) 3/0-400 kcmil
ND, HND, CND, CHND, NDC CLD, ③ CNDC ②	800-1000 1200	(3) 3/0-400 kcmil (4) 4/0-500 kcmil
NGS, NGH, NGC, CNGS CNGH, CNGC	400-1200	(4) 4/0-500 kcmil or (3) 500-750 kcmil

② Suitable for dc applications only.

③ LHH is 400 A maximum.

Table 22.0-6. Fusible Switch Terminals

Ampere Rating	Wire Size Ranges
30	#14-1/0
60	#14-1/0
100	#14-1/0
200	#4-300 kcmil
400	250-750 kcmil or (2) 3/0-250 kcmil
600	(2) #4-600 kcmil or (4) 3/0-250 kcmil
800	(3) 250-750 kcmil or (6) 3/0-250 kcmil
1200	(4) 250-750 kcmil or (8) 3/0-250 kcmil

Series Rated Combinations

UL permits panelboards to be labeled with a short-circuit rating of up to 200,000 A symmetrical where UL listed combinations of main and branch circuits are used.

These combinations consist of main breakers or fusible devices connected ahead of, and in series with approved conventional devices.

Two arrangements are acceptable and comply with UL standards for panelboards. The main circuit breaker may be installed in the panel as a main device (**Figure 22.0-4**), or it may be mounted remote (**Figure 22.0-5**) from the panel. In either case, the approved main and branch combinations must be followed. These arrangements are acceptable and are UL listed having been tested in accordance with UL standards.

From the tables on **Page 22.0-14** through **Page 22.0-22**, specific combinations of main devices (upstream) and branch devices (downstream), series connected and electrically adjacent in the system, may be selected to qualify the assembled panelboard for the short-circuit ratings shown. Series ratings apply **only** to those Eaton breakers listed and published. **Do not use "Classified" breakers.**

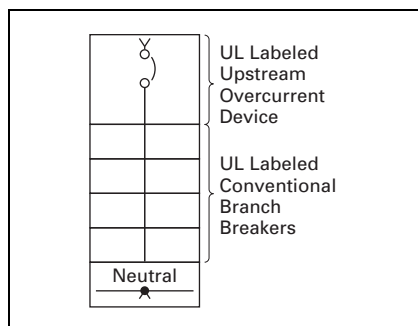

Figure 22.0-4. Main Device

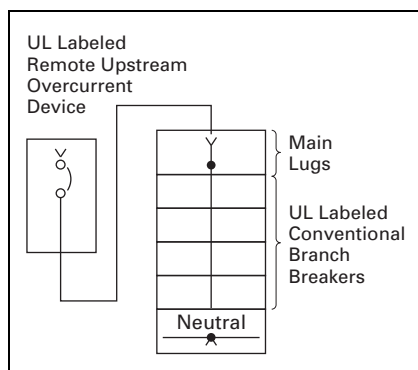

Figure 22.0-5. Mounted Remote

Industry standards and the NEC require protection of the entire electrical distribution system from damage due to short-circuit faults. Article 230.205 of the NEC states that service equipment shall be suitable for the short-circuit current available at its supply terminals. The entire distribution system is required to meet this standard. Series rated systems have become an effective method of meeting these requirements.

There are three protection systems used to protect low voltage power distribution equipment. They are:

- Fully rated protection
- Fully rated, selectively coordinated protection
- Series rated protection

Fully Rated Protection—Where all overcurrent devices are rated for the full prospective short-circuit current at their line side terminals throughout the system.

Selectively Coordinated Protection—A fully rated system where the overcurrent device closest to the fault will open first, thus isolating the faulty circuit.

Series Rated Protection—A short-circuit interrupting rating assigned to a combination of two or more overcurrent protective devices that are connected in series and in which the rating of the downstream device(s) in the combination is less than the series rating.

Series ratings are also known in the industry as integrated ratings, series combination ratings and series connected ratings.

UL Issues

In a series rated system, all of the overcurrent devices in series in the protective scheme must have been tested and listed by Underwriters Laboratories for series combination use in the system.

All Eaton's series ratings are in full compliance with all applicable requirements of the latest editions of UL 489, 891 and 67.

The UL Recognized Component Directory (the Yellow Book) contains breaker manufacturers' series connected listings. These are intended **ONLY** as a guideline for use by others who are responsible for their own testing, labeling and listing. Therefore, the UL Recognized Component Directory cannot be used

to interpret series connected ratings in assembled equipment. The assembled equipment must also be UL tested for series ratings.

Code Issues

The fault current contribution of motors connected between series rated breakers must be considered. Article 240.86 in the NEC states that for series ratings, the sum of the motor full-load currents cannot exceed 1% of the interrupting rating of the lower rated circuit breaker. The actual fault current contribution from induction motors is about four times their full-load current (impedance value of 25%). For example, if the downstream branch circuit breakers used in a series rated combination have an interrupting rating of 14,000 A rms symmetrical for a 480 V system, the maximum allowable motor contribution to that panel from the branch circuit breakers is 140 A (1%). For typical induction motors, this is equivalent to a total horsepower at 480 V of approximately 115 horsepower.

Requirements of the NEC (NFPA-70) for series ratings may be met by equipment marked with ratings adequate for the available fault current at the point of application in the electrical system. Eaton panelboards and switchboards are marked consistent with NEC Article 240.83.

Additionally, Article 110.22 requires field marking on equipment where series ratings are used. This label is supplied standard with all Eaton panelboards and switchboards.

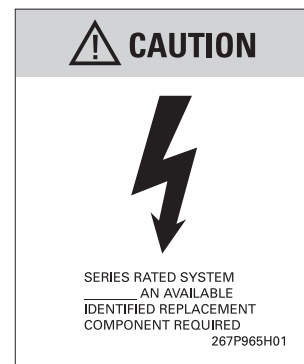

NEC Required Caution Label

Note: The NEC requires the installer to properly apply and complete this label. Label(s) must be placed on all equipment where series ratings are used.

Fuse Application Considerations

Fuses can be used instead of circuit breakers in fully rated, selectively coordinated and series connected protection systems. See the tables on **Page 22.0-19** through **Page 22.0-20** for fuse breaker data applied to series connected designs.

Don't apply fuses using the up-over-down method, which has been recommended by some fuse manufacturers for sizing a current-limiting fuse that protects a downstream molded-case circuit breaker with a specified rms symmetrical interrupting rating. The method can lead to erroneous and unsafe conclusions, and should not be used.

Example: Assume a specific type of current-limiting fuse rated 2000 A. Then using the figure below:

1. Draw a vertical line from the prospective short-circuit current of 200 kA to intersect the typical peak let-through curve at "A."
2. Draw a horizontal line left from Point "A" to intersect the "prospective peak" curve at "B."
3. Drop a vertical line from "B" to intersect the horizontal axis and read the recommended rating, 65 kA rms, concluding that a circuit breaker with a 65 kA interrupting capacity will be protected by a specified 2000 A current-limiting fuse.

This conclusion is wrong when the downstream service has a blow-open contact assembly, as does a molded-case circuit breaker or similar device.

The reason: The up-over-down method ignores dynamic impedance (the inherent current-limiting of the downstream molded-case circuit breaker). Such impedance is developed directly by the forces of the let-through current created when the contacts are blown open.

For proper application of current-limiting fuses, always refer to recommendations by the manufacturer of the circuit breaker, which are based on actual test data.

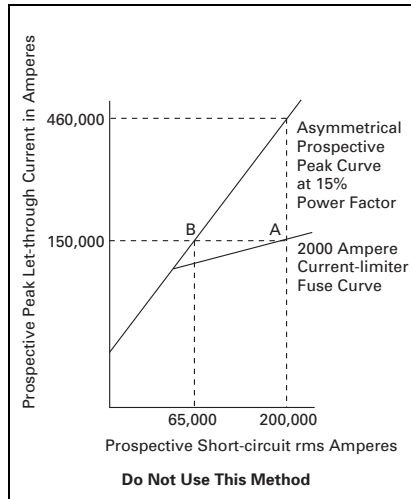

Figure 22.0-6. Old Up-Over-Down Chart

Applying Series Ratings

The following is provided to use the series rating tables on the following pages.

- Step 1. Determine the available system voltage and fault current.
- Step 2. Select the appropriate table using the system voltage.
- Step 3. Use the appropriate "Series Equipment Rating" column equal to, or greater than, the available fault current, to determine the allowable combinations of main (upstream) and branch (downstream) overcurrent devices. Main devices are shown in bold/shaded areas. Respective branch breakers are shown directly below their associated main device. If a rating is not initially found in a column, first look to the columns to the right for higher "Series Equipment Ratings" within the same table. If still not found, use ratings from table of a higher system voltage (higher numbered tables).

Example 1:

240 V, three-phase, three-wire, AC system with available fault current of 37,438 A. Main (upstream) device is a three-pole, 150 A, FD breaker. The branch (downstream) breakers are two- and three-pole, 20, 30 and 60 A, 240 V, BAB breakers.

1. Go to the 240V table (**Table 22.0-8**).
2. Look down under the 42 kA column. This rating is not shown.
3. Look to the columns to the right. This rating is shown under the 65 kA column, and therefore is valid.

Example 2:

480Y/277 V, three-phase, four-wire, AC system with available fault current of 62,097 A. Main (upstream) device is a three-pole, 250 A, HJD breaker. The branch (downstream) breakers are two- and three-pole, 60, 70 and 100 A FDB breakers.

1. Go to the 480Y/277 V table (**Table 22.0-11**).
2. Look down under the 65 kA column. This rating is not shown.
3. Look to the columns to the right. This rating is still not shown.
4. Look at the table with the next higher system voltage (480 V, **Table 22.0-12**).
5. This rating is shown under the 65 kA column, and therefore is valid.

Example 3:

208Y/120 V, three-phase, four-wire, AC system with available fault current of 56,438 A. Main (upstream) device is a three-pole, 225 A, ED breaker. The branch (downstream) breakers are single-pole, 20 A BAB (120/240 V), and two- and three-pole, 70 A BAB (240 V).

1. Go to the 240 V table (**Table 22.0-8**).
2. Look under the 65 kA column. This rating is shown under the 65 kA column, and therefore is valid for the two- and three-pole (240 V) breakers.
3. Look at the 120/240 V table (**Table 22.0-7**) for the single-pole (120/240 V) rating.
4. Look under the 65 kA column. This rating is shown under the 65 kA column, and therefore is valid for the single-pole (120/240 V) breakers.

Other Applications of Series Ratings

Series ratings can also be applied under the following guidelines:

Any FULLY RATED breaker can be applied upstream, downstream, or in the middle of, any of the series ratings stated in the tables.

Any series rating stated in the tables may have additional branch breakers of the EXACT SAME TYPE further downstream in that rating.

COMBINING SERIES RATINGS is allowed under certain conditions.

Main and branch series ratings may be combined if:

Breakers A, B and C are in series respectively from main to branch. Breakers A and B series rate together, breakers A and C series rate at the same interrupting rating level (or higher), it is allowable to use A, B and C together at the A-B series rating.

It is improper to combine series ratings under the following condition:

Breakers A, B and C are in series respectively from main to branch. Breakers A and B series rate together,

breakers B and C series rate at the same interrupting rating level (or higher), it is **NOT** allowable to use A, B and C together at the A-B or B-C series rating. However, combining multiple overcurrent devices as in this example, can be accomplished if all devices in the series combination have been tested together and listed in triple rating **Table 22.0-20**.

Main devices shown centered at top in shaded area, respective branch devices shown directly below.

Table 22.0-7. 120/240 Vac—Breaker/Breaker Series Ratings

Main devices are shown centered at top, in shaded area. Respective branch devices shown directly below.

Main Breaker Maximum Amperes	Series Equipment Rating—kA Symmetrical									
	18	22	42	65	100	200				
100	EHD BAB HQP QBGF QBGFT QBACAF	QBHW QPHW BAB HQP QBGF QPGF QBAG QBHW QPHW QBHW QPHW QBGFT QPGFT QPGFT		GB, GHB BAB HQP QBGF QPGF QBAG QBHW QPHW QBHW QPHW QBGFT QPGFT QBACAF			FB-P BAB HQP QBGF QPGF QBAG QBHW QPHW EHD FD QBGFT QPGFT			FCL BA HQP QBGF QPGF QBAG QBHW QPHW GB, GHB GHQ EHD FD HFD QBGFT QPGFT QBACAF
125				BRX BAB (15–70 A) BAB (90–100 A) HQP (15–70 A) HQP (90–100 A)			EGH GHQ, GHB			
150	FDB BAB HQP QBGF QBAG QBGFT QBACAF			FDE BAB HQP QBHW QPHW			HFDE BAB HQP GHB EHD FD (15–150 A) QBHW QPHW			
200							LA-P BAB HQP QBHW QPHW EHD FD			

Table 22.0-7. 120/240 Vac—Breaker/Breaker Series Ratings (Continued)

Main devices are shown centered at top, in shaded area. Respective branch devices shown directly below.

Main Breaker Maximum Amperes	Series Equipment Rating—kA Symmetrical										
	18	22	42	65	100	100	200	200		200	
225		EDB BAB HQP QBGF QPGF QBHGF QPHGF QBHW QPHW QBAG QBGFT QPGFT QBHGFT QPHGFT	EDS BAB HQP QBGF QPGF QBHGF QPHGF QBHW QPHW QBAG QBGFT QPGFT QBHGFT QPHGFT QBCAF	ED, FD BAB HQP QBGF QPGF QBAG QBHW QBHGF QBGFT QPGFT QBCAF	FDE QBGF QPGF QBAG QBHGF QBGFT QPGFT QBHGF QBCAF QPHGF QPHGFT	HFDE BAB HQP QBHW QPHW	EDH, EDC BAB ① HQP ① QBGF QPGF QBAG QBHGF QPGFT QBCAF	HFD BAB HQP QBGF QBAG QBHW QPHW QBHGF GB, GHB GHQ, GHQSP EHD, EGS FD QBGFT QPGFT QBCAF	FDC BAB HQP QBHW QPHW HFDE BAB HQP QBGF QBAG QBHW QPHW QBHGF GHB, EHD FD (15–150 A) QBGFT EGS FDE (15–150 A) QBCAF QBHGF QPGF QPGFT QPHGF QPHGFT	FDC GB, GHB GHQ EHD FD HFD EGS EGH	
250				JD, JDB BAB (15–70 A) HQP (15–70 A) QBHW QPHW EHD	HJD BAB HQP QBHW QPHW	JDC QBGF QPGF QBAG QBHGF QPGFT QBCAF	HJD GB, GHB EHD FD EGS	JDC BAB HQP QBHW QPHW		JDC GB, GHB EHD FD HFD EGS EGH	
400		DK, KD KDB BAB HQP QBGF QPGF QBAG QBGFT QPGFT	DK, KD KDB, CKD BAB (15–70 A) HQP (15–70 A) QBHW QPHW	HKD, CHKD BAB (15–70 A) HQP (15–70 A) QBHW QPHW	DK, KD KDB CKD EHD	KDC BAB (15–70 A) HQP (15–70 A)	HKD CHKD GB, GHB EHD FD EGS ②	KDC QBHW QPHW		KDC GB, GHB EHD FD HFD EGS EGH	LCL BAB HQP QBGF QPGF QBAF QBAG QBHW QPHW GB, GHB EHD FD HFD QBGFT QPGFT QBCAF
600							CHLD, HLD EHD				
800							HMDL EHD				
1200							HND CHND NGH NGH-C EHD EDB EDS ED				

① Single-pole version is restricted to 15–70 A.

② Not valid with CHKD.

Series Rated Combinations

Table 22.0-8. 240 Vac—Breaker/Breaker—Series Ratings

For single- and two-pole 120/240V rated breakers (BA, BAB, HQP, QBHW, QPHW), see **Table 22.0-7**. Main devices are shown centered at top, in shaded area. Respective branch devices shown directly below.

Main Breaker Maximum Amperes	Series Equipment Rating — kA Symmetrical								
	18	22	42	65		100			200
100	EHD BAB_H HQP_H	QBHW_H QPHW_H BAB_H HQP_H		GB, GHB BAB_H HQP_H QBHW_H QPHW_H		FB-P BAB_H HQP_H EHD FDB FD			FCL BAB_H HQP_H QBHW_H QPHW_H GB, GHB EHD FD, FDE FDB HFD, HFDE
125						EGH GHB			
150	FDB BAB_H HQP_H								
200						LA-P BAB_H HQP_H QBHW_H QPHW_H EHD FDB FD JD, JDB			
225		EDB HQP_H BAB_H QBHW QPHW	EDS HQP_H BAB_H QBHW QPHW CHH BAB_H	ED BAB_H HQP_H QBHW_H	FD, FDE BAB_H HQP_H QBHW_H QPHW_H EHD ① FDB	EDH, EDC BAB_H HQP_H	HFD, HFDE BAB_H HQP_H QBHW_H QPHW_H GB, GHB EHD FDB FD, FDE	FDC BAB_H HQP_H QBHW_H QPHW_H	FDC GB, GHB EHD FDB FD, FDE HFD, HFDE
250			JD, JDB BAB_H (15-70A) HQP_H (15-70 A) QBHW_H QPHW_H EHD FDB	HJD BAB_H (15-70 A) HQP_H (15-70 A) QBHW_H QPHW_H	HJD GB, GHB EHD FD FDB ED JD, JDB EGS	JDC BAB_H HQP_H QBHW_H QPHW_H		JDC GB, GHB EHD FD, FDE FDB HFD, EDB, EDS ED, HFDE EDH JD, JDB HJD, EGS, EGH	

① Valid on two- and three-pole breaker only. Not valid for single-pole.

Table 22.0-9. 240 Vac—Breaker/Breaker—Series Ratings

For single- and two-pole 120/240 V rated breakers (BA, BAB, HQP, QBHW, QPHW), see **Table 22.0-7**.

Main devices are shown centered at top, in shaded area. Respective branch devices shown directly below.

Main Breaker Maximum Amperes	Series Equipment Rating—kA Symmetrical				
	65	100	200	200	200
400	DK, KD, KDB CKD BAB_H HQP_H QBHW_H QPHW_H EHD FDB	HKD, CHKD QBHW_H ① QPHW_H ① GB, GHB EHD FDB, FDE FD, EDB, EDS ED JD, JDB DK, KD, KDB EGS ②	KDC QBHW_H QPHW_H	KDC GB, GHB EHD FDB FD, FDE HFD, EDB, EDS, HFDE ED EDH JD, JDB HJD DK, KD, KDB HKD	LCL BAB_H HQP_H QBHW_H QPHW_H GB, GHB EHD FDB FD, HFD, EDB, EDS ED, FDE, HFDE EDH JD, JDB HJD DK, KD, KDB HKD
500		NB-P JD, JDB KD, KDB, DK CKD			
600		HLD, HLDB, CHLD GB ①, GHB ① FD, EDB, EDS ED, EHD JD, JDB KD, KDB, DK, CKD LD, LDB		LDC EDB, EDS, ED EDH	
800		NB-P KD, KDB, DK	HMDL EHD FD		
1200		HND, CHND EDB, EDS, ED EHD			NDC EDB, EDS, ED EDH
2500		RD EDB, EDS, ED			RDC EDB, EDS, ED EDH

① Valid on two- and three-pole breakers only. Not valid for single-pole.

② Not valid with CHKD.

Series Rated Combinations (Continued)

Main devices shown in shaded area, respective branch devices shown directly below.

Table 22.0-10. 277 Vac—Breaker/Breaker Series Ratings

Main devices are shown centered at top, in shaded area. Respective branch devices shown directly below.

All ratings in this table apply to single-pole branch breakers only. For two- and three-pole branch breakers, see other tables.

Main Breaker Maximum Amperes	Series Equipment Rating—kA Symmetrical					
	22	25	35	65	100	150
100						FCL GHB GHQ, GHQRSP EHD FD HFD
125			EGS GHQ, GHB	EGH GHQ, GHB		
225			FD, FDE GHB GHQ GHQRSP ① GHBGFEP ①	HFD, HFDE GHB GHQRSP ② GHBGFEP ② GHQ EHD FD	FDC GHB EHD FD HFD	
250	JD, JDB GHB		JD, JDB GHB (15–50 A) GHBGFEP ③	HJD GHB (15–50 A) EHD FD GHBGFEP	LCL FDC	JDC GHB EHD FD HFD
400	KD, KDB CKD GHB	HKD CHKD GHB	KD, KDB CKD GHB EHD FD GHQ ④	HKD, CHKD GHB EHD FD GHQ ⑤	KDC GHB EHD FD HFD	LCL GHB EHD FD HFD

- ① Not valid with FDE.
- ② Not valid with HFDE.
- ③ Not valid with JDB.
- ④ Not valid with KDB or CKD.
- ⑤ Not valid with CHKD.

Table 22.0-11. 480Y/277 Vac—Breaker/Breaker Series Ratings

Main devices are shown centered at top, in shaded area. Respective branch devices shown directly below.

All ratings in this table apply to two- and three-pole branch breakers only. For single-pole branch breakers, see **Table 22.0-10**.

Main Breaker Maximum Amperes	Series Equipment Rating—kA Symmetrical					
	22	25	35	65	100	150
100						FCL GHB, GHQRSP
125			EGS GHB	EGH GHB		
225			FD, FDE GHB, GHQRSP ⑥	HFD, HFDE GHB, GHQRSP ⑦	FDC GHB	
250	JD, JDB GHB		JD, JDB GHB (15–50 A)	HJD GHB (15–50 A)	JDC GHB	
400	KD, KDB CKD GHB	HKD, CHKD GHB	KD, KDB CKD GHB (15–50 A)	HKD, CHKD GHB (15–50 A)	KDC GHB (15–50 A)	LCL GHB

- ⑥ Not valid with FDE.
- ⑦ Not valid with HFDE.

Series Rated Combinations (Continued)

Main devices shown in shaded area, respective branch devices shown directly below.

Table 22.0-12. 480 Vac—Breaker/Breaker Series Ratings

Main devices are shown centered at top, in shaded area. Respective branch devices shown directly below. All ratings in this table apply to two- and three-pole branch breakers only. Not valid for single-pole branch breakers.

Main Breaker Maximum Amperes	Series Equipment Rating—kA Symmetrical					
	25	35	65	100	150	
100				FB-P EHD FDB FD HFD		FCL EHD FDB FD, FDE HFD, HFDE
200				LA-P EHD FDB FD HFD JD, JDB HJD		
225		FD, FDE EHD FDB	HFD, HFDE EHD FDB FD, FDE EGS ①	FDC EHD, EGS, EGH FDB FD, FDE HFD, HFDE		
250	JD, JDB EHD FDB		HJD EHD FDB FD FDE JD, JDB EGS	JDC EHD, EGS, EGH FDB FD, FDE HFD, HFDE JD, JDB HJD		LCL FDE, HFDE
400		KD, KDB EHD FDB	HKD EHD FDB FD, FDE JD, JDB KD, KDB EGS	KDC EHD, EGS, EGH FDB FD, FDE HFD, HFDE JD, JDB HJD KD, KDB HKD	LA-P JD, JDB HJD KD, KDB HKD	LCL EHD FDB FD, FDE HFD, HFDE FDC JD, JDB HJD KD, KDB HKD
500				NB-P JD, JDB HJD KD, KDB HKD		
600		LD, LDB CLD JD, JDB	HLD, HLDB CHLD FD, FDE JD, JDB KD, KDB LD, LDB			

① Not valid with HFDE.

Series Rated Combinations (Continued)

Table 22.0-13. 600 Vac—Breaker/Breaker Series Ratings

Main fuse class shown centered at top, in shaded area. Respective branch devices shown directly below. All ratings in this table apply to two- and three-pole branch breakers only. Not valid for single-pole branch breakers.

Main Breaker Maximum Amperes	Series Equipment Rating—kA Symmetrical					
	18	25	35	42	50	100
225	FD FDB	HFD FDB FD	FDC FDB FD, FDE HFD, HFDE			
250	JD, JDB FDB	HJD FDB FD JD, JDB	JDC FDB FD HFD JD, JDB HJD			LCL FDE, HFDE
400		KD, KDB CKD FDB FD JD, JDB	HKD, CHKD FDB FD, FDE HFD, HFDE JD, JDB HJD	KDC FDB FD, FDE HFD, HFDE	KDC JD, JDB HJD KD, KDB HKD	LCL FDB FD, FDE HFD, HFDE FDC JD, JDB HJD JDC KD, KDB HKD KDC
600		LD, LDB CLD FD JD, JDB	HLD, HLDB CHLD KD, KDB LD, LDB			

Table 22.0-14. 120/240 Vac—Fuse/Breaker Series Ratings

Main fuse class shown centered at top, in shaded area. Respective branch devices shown directly below.

Main Fuse Maximum Amperes	Series Equipment Rating—kA Symmetrical					
	100			200		
100						R BAB HQP QBHW QPHW GB GHB
200			R GB GHB	J BAB HQP QBHW QPHW	T BAB HQP QBHW QPHW	
400	J BAB HQP QBHW QPHW	T BAB HQP QBHW QPHW		J GB GHB	T GB GHB	

Series Rated Combinations (Continued)

Main devices shown in shaded area, respective branch devices shown directly below.

Table 22.0-15. 240 Vac—Fuse/Breaker Series Ratings

For single- and two-pole 120/240 V rated breakers (BA, BAB, HQP, QBHW, QPHW), see **Table 22.0-14**.

Main fuse class shown centered at top, in shaded area. Respective branch devices shown directly below.

Main Fuse Maximum Amperes	Series Equipment Rating—kA Symmetrical					
	100		200			
100						R BAB_H HQP_H QBHW_H QPHW_H GB GHB
200			R GB GHB	J BAB_H HQP_H QBHW_H QPHW_H	T BAB_H HQP_H QBHW_H QPHW_H	R GB ① GHB ①
400	J BAB_H HQP_H QBHW_H QPHW_H	T BAB_H HQP_H QBHW_H QPHW_H		J GB GHB	T GB GHB	
600			L EHD FDB FD, FDE ED JD, JDB DK, KD, KDB			

① Valid on two- and three-pole breakers only. See **Table 22.0-14** for single-pole.

Table 22.0-16. 277 Vac Fuse/Breaker Series Ratings

Main fuse class are shown centered at top, in shaded area. Respective branch devices shown directly below. All ratings in this table apply to single-pole branch breakers only. For two- and three-pole branch breakers, consult other tables.

Main Fuse Maximum Amperes	Series Equipment Rating—kA Symmetrical					
	65		100		200	
100			J GHQ GHQRSP	T GHQ GHQRSP		R GHB
200	J GHQ GHQRSP	T GHQ GHQRSP	J EHD FD HFD	T EHD FD HFD	R GHB	
400						J GHB T GHB

Series Rated Combinations (Continued)

Table 22.0-17. 480Y/277 Vac—Fuse/Breaker Series Ratings

Main fuse class shown centered at top, in shaded area. Respective branch devices shown directly below. All ratings in this table apply to two- and three-pole branch breakers only. For single-pole branch breakers, see **Table 22.0-16**.

Main Fuse Maximum Amperes	Series Equipment Rating – kA Symmetrical					
	65		100		200	
100						R GHB
200			R GHB			
400				J GHB	T GHB	
600			J EHD FD, FDE HFD FDC HFDE	T GHB EHD FD, FDE HFD, HFDE FDC JD HJD JDC		

Table 22.0-18. 480 Vac—Fuse/Breaker Series Ratings

Main fuse class shown centered at top, in shaded area. Respective branch devices shown directly below. All ratings in this table apply to two- and three-pole branch breakers only. Not valid for single-pole branch breakers.

Main Fuse Maximum Amperes	Series Equipment Rating – kA Symmetrical					
	100			200		
100			R EHD			
200	J EHD FD HFD FDC	T EHD FD HFD FDC				

Table 22.0-19. 600 Vac—Fuse/Breaker Series Ratings

Main fuse class shown centered at top, in shaded area. Respective branch devices shown directly below. All ratings in this table apply to two- and three-pole branch breakers only. Not valid for single-pole branch breakers.

Main Fuse Maximum Amperes	Series Equipment Rating – kA Symmetrical					
	100			200		
100				R FD, FDE HFD, HFDE FDC		
200	J FD, FDE HFD, HFDE FDC	T FD, FDE HFD, HFDE FDC		R JD HJD JDC		
400	J JD HJD JDC	T JD HJD JDC		R KD HKD KDC		
600				J KD HKD KDC	T KD HKD KDC	

Table 22.0-20. Triple Series Ratings

Main Fuse Class and Maximum Amperes	Tenant Main Type	Branch Type	System Voltage	Short-Circuit Series Rating (kA, Sym.)
L-6000	DK, KD, KDB	GB, GHB, EHD ①	240	100
L-6000	DK, KD, KDB	GB, GHB	120/240	100
L-6000	DK, KD, KDB	FD ①, FDB	240	100
L-6000	DK, KD, KDB	JD, JDB	240	100
L-6000	JD, JDB	GB, GHB	240	100
L-6000	JD, JDB	GB, GHB	120/240	100
L-6000	FD	GB, GHB	240	100
L-6000	FD	GB, GHB	120/240	100
L-6000	FD, FDB	BAB_H, HQP_H QBHW_H, QPHW_H	240	100
L-6000	FD, FDB	BA, BAB HQP (15–70 A)	120/240	100
L-6000	EHD	BAB_H, HQP_H	240	100
L-6000	EHD	BA, BAB, HQP	120/240	100

① Valid on two- and three-pole breakers only. Not valid for single-pole.

Pow-R-Line 1a



Pow-R-Line 1a

General Description

Panelboard Ratings

Voltage

- 240 Vac maximum

Main Lugs

- 100–600 A

Main Breakers

- 100–600 A

Branch Breakers

- 15–100 A
(Bolt-on or plug-on chassis)

Short-Circuit Current Ratings (Symmetrical)

- 240 Vac: 10 kA and 22 kA fully rated
- 240 Vac: 22–200 kA series rated

Service

- Three-phase, four-wire 208Y/120 V and 240/120 V delta
- Single-phase, three-wire 120/240 V
- Single-phase, two-wire 120 V
- Three-phase, three-wire 208 V and 240 V

Suitable for service entrance applications when specified.

Mains

For available mains, refer to **Table 22.1-1**.

Main breakers, 100 A, Types BAB and QBH are horizontally mounted, same as branch breakers. All other main breakers are vertically mounted.

Branch Circuits

For available branch devices, refer to **Table 22.1-2**.

Main Lugs Only

The short-circuit rating of the MLO assembled panelboard will be fully rated based upon the lowest rated branch device or may be series rated with an approved upstream device.

Main lugs only ampere ratings: 100, 225, 400 and 600.

Main Circuit Breakers

The short-circuit rating shown is that of the main breaker only. The short-circuit rating of the assembled panelboard is the rating of the lowest fully rated main or branch device or the rating of an approved series rated combination.

Table 22.1-1. Main Circuit Breakers

Breaker Frame Amperes	Breaker Type	Interrupting Rating (kA Symmetrical) at 240 Vac
100	BAB	10
100	QBHW	22
100	EHD	18
150	FDB	18
225	FD, FDE	65
225	HFD, HFDE	100
225	FDC, FDCE	200
225	EDB	22
225	EDS	42
225	ED	65
225	EDH	100
225	EDC	200
250	JD	65
250	HJD	100
250	JDC	200
400	DK	65
400	KD	65
400	HKD	100
400	KDC	200
400	LHH	100
600	LGE	65
600	LGS	85
600	LGH	100
600	LGC	200
600	LGU	200

Table 22.1-2. Branch Circuit Breakers

Breaker Type	Ampere Rating	Number of Poles	Interrupting Rating (kA Symmetrical)		
			120 Vac	120/240 Vac	240 Vac
BAB, HQP	15–70	1	10	—	—
BAB, HQP	15–100	2	—	10	—
BAB, HQP	15–100	2, 3	—	—	10
BAB-D ①, HQP-D ①	15–60	1, 2	10	10	—
BAB-C ②, HQP-B ②	15–30	1, 2	10	10	—
BABRP ③	15–30	1, 2	10	10	—
BABRSP ③	15–30	1, 2	10	10	—
QBGF, QBGFEP	15–50 ④	1, 2	10	10	—
QPGF, QPGFEP	15–50 ④	1, 2	10	10	—
QBCAF ⑤	15–20	1	10	10	—
QBHW	15–70	1	22	—	—
QBHW	15–100	2	—	22	—
QBHW	15–100	2, 3	—	—	22
QBHGF, QBGFEP	15–30	1, 2	22	22	—
QPHGF, QPHGFEP	15–30	1, 2	22	22	—
QBHCAF ⑤	15–20	1	22	22	—

① HID (High Intensity Discharge) rated breaker.

② Switching neutral breaker. Single-pole device requires two-pole space, two-pole device requires three-pole space.

③ Solenoid operated breaker.

④ 50 A is two-pole only.

⑤ Arc fault breaker.

Series Rated Combinations

Refer to series rating tables beginning on **Page 22.0-14** for the approved series rated combinations available for the branch circuit breakers listed in **Table 22.1-2**.

Technical Data and Specifications

Bussing

100–400 A: Tin-plated aluminum is standard, copper is available as an option.

600 A: Only copper density is available for these applications.

Boxes

Boxes are made from code-gauge galvanized steel.

Blank ends are supplied as standard, knockouts are available upon request.

EZ Trim

Trims are made from code-gauge steel and painted ANSI 61 gray.

All panelboards have door-in-door as standard with multi-point catch and lock, and concealed mounting hardware.

Modifications

Table 22.1-3. Sub-Feed Lugs (Main Lugs Only)

Ampere Rating	Panel Height Addition
100 225	0 Inches (0 mm) 0 Inches (0 mm)

Table 22.1-4. Through-Feed Lugs

Ampere Rating	Information
100 225 400 600	See Table 22.1-6 See Table 22.1-6 See Table 22.1-6 See Table 22.1-6

Table 22.1-5. Sub-Feed Breakers (One Per Panel)

Ampere Rating	Breaker Type	Interrupting Rating (kA Symmetrical) at 240 V
150	FDB	18
225	FD	65
225	HFD	100
225	FDC	200
225	EDB	22
225	EDS	42
225	ED	65
225	EDH	100
225	EDC	200
250	JD	65
250	HJD	100
250	JDC	200
400	DK	65
400	KD	65
400	HKD	100
400	KDC	200
600	LGE	65
600	LGS	85
600	LGH	100
600	LGC	100

Shunt Trips

Shunt trips are available on breakers. BAB, HQP, QBHW and QPHW require one additional pole space for shunt trip, i.e., single-pole is two-pole size, two-pole is three-pole size and three-pole is four-pole size.

Ground Bar

Standard bolted in box. Aluminum is standard, copper is available as an option.

Enclosures

Types 1, 12, 3R, 4 and 4X.

Surge Protective Device (SPD)

Integrated onto panelboard chassis. For complete product description and available ratings, refer to **Tab 34**.

Box Sizing and Selection

Box size for all Type 1 panelboards are available from **Table 22.1-6**.

Instructions

1. Select the rating and type of mains required.
2. Count total number of branch circuit poles (including spaces) required in the panelboard. Do not count main breaker poles. Convert two- or three-pole branch breakers to single-poles, i.e., three-pole breaker, count as three poles.

Note: For horizontal mounted mains (BAB Type), use main lug table, include space in branch section for mains.

3. Using correct table, type of mains and ampere rating per Step 1, find total number of poles.

Note: Where total number of poles (Step 2) fall between number in table, use the next higher number.

4. Read box size across columns to the right.

Top and Bottom Gutters (Minimum)

5.50 inches (139.7 mm).

Side Gutters

20.00-inch (508.0 mm) wide box:
6.50 inches (165.1 mm).

Table 22.1-6. Type 1 Panelboards—Dimensions in Inches (mm)

Panelboard Types	Types and Mounting Position (H) = Horizontal / (V) = Vertical			Maximum Number of Branch Circuits Including Provisions	Box Dimensions ^{①②③}			Catalog Number			
	Main Breaker	Sub-Feed Breaker	Dual Sub-Feed Breaker		Height	Width	Depth	YS Box	LT Trim	EZ Box	EZ Trim
100A											
Main breaker	BAB, QBHW (H)	—	—	15	36.00 (914.4)	20.00 (508.0)	5.75 (146.1)	YS2036	LT2036S or F	EZB2036R	EZT2036S or F
		—	—	27	48.00 (1219.2)	20.00 (508.0)	5.75 (146.1)	YS2048	LT2048S or F	EZB2048R	EZT2048S or F
		—	—	39	48.00 (1219.2)	20.00 (508.0)	5.75 (146.1)	YS2048	LT2048S or F	EZB2048R	EZT2048S or F
		—	—	42	60.00 (1524.0)	20.00 (508.0)	5.75 (146.1)	YS2060	LT2060S or F	EZB2060R	EZT2060S or F
Main lugs	—	—	—	18	36.00 (914.4)	20.00 (508.0)	5.75 (146.1)	YS2036	LT2036S or F	EZB2036R	EZT2036S or F
				30	36.00 (914.4)	20.00 (508.0)	5.75 (146.1)	YS2036	LT2036S or F	EZB2036R	EZT2036S or F
				42	48.00 (1219.2)	20.00 (508.0)	5.75 (146.1)	YS2048	LT2048S or F	EZB2048R	EZT2048S or F
				48	48.00 (1219.2)	20.00 (508.0)	5.75 (146.1)	YS2048	LT2048S or F	EZB2048R	EZT2048S or F
	—	—	—	54	48.00 (1219.2)	20.00 (508.0)	5.75 (146.1)	YS2048	LT2048S or F	EZB2048R	EZT2048S or F
				60	60.00 (1524.0)	20.00 (508.0)	5.75 (146.1)	YS2060	LT2060S or F	EZB2060R	EZT2060S or F
				72	60.00 (1524.0)	20.00 (508.0)	5.75 (146.1)	YS2060	LT2060S or F	EZB2060R	EZT2060S or F
				84	72.00 (1828.8)	20.00 (508.0)	5.75 (146.1)	YS2072	LT2072S or F	EZB2072R	EZT2072S or F
Main breaker	EHD, FDB, FD, FDE, HFD, FDC, HFDE, FDCE (V)	—	—	18	36.00 (914.4)	20.00 (508.0)	5.75 (146.1)	YS2036	LT2036S or F	EZB2036R	EZT2036S or F
				30	48.00 (1219.2)	20.00 (508.0)	5.75 (146.1)	YS2048	LT2048S or F	EZB2048R	EZT2048S or F
				42	48.00 (1219.2)	20.00 (508.0)	5.75 (146.1)	YS2048	LT2048S or F	EZB2048R	EZT2048S or F
				48	60.00 (1524.0)	20.00 (508.0)	5.75 (146.1)	YS2060	LT2060S or F	EZB2060R	EZT2060S or F
	—	—	—	54	60.00 (1524.0)	20.00 (508.0)	5.75 (146.1)	YS2060	LT2060S or F	EZB2060R	EZT2060S or F
				60	60.00 (1524.0)	20.00 (508.0)	5.75 (146.1)	YS2060	LT2060S or F	EZB2060R	EZT2060S or F
				72	72.00 (1828.8)	20.00 (508.0)	5.75 (146.1)	YS2072	LT2072S or F	EZB2072R	EZT2072S or F
				84	72.00 (1828.8)	20.00 (508.0)	5.75 (146.1)	YS2072	LT2072S or F	EZB2072R	EZT2072S or F
Main lugs with 100 A through-feed lugs or sub-feed breaker	—	EHD, FDB, FD, FDE, HFD, FDC, HFDE, FDCE (V)	—	18	48.00 (1219.2)	20.00 (508.0)	5.75 (146.1)	YS2048	LT2048S or F	EZB2048R	EZT2048S or F
				30	48.00 (1219.2)	20.00 (508.0)	5.75 (146.1)	YS2048	LT2048S or F	EZB2048R	EZT2048S or F
				42	60.00 (1524.0)	20.00 (508.0)	5.75 (146.1)	YS2060	LT2060S or F	EZB2060R	EZT2060S or F
				48	60.00 (1524.0)	20.00 (508.0)	5.75 (146.1)	YS2060	LT2060S or F	EZB2060R	EZT2060S or F
	—	—	—	54	60.00 (1524.0)	20.00 (508.0)	5.75 (146.1)	YS2060	LT2060S or F	EZB2060R	EZT2060S or F
				60	60.00 (1524.0)	20.00 (508.0)	5.75 (146.1)	YS2060	LT2060S or F	EZB2060R	EZT2060S or F
				72	72.00 (1828.8)	20.00 (508.0)	5.75 (146.1)	YS2072	LT2072S or F	EZB2072R	EZT2072S or F
				84	72.00 (1828.8)	20.00 (508.0)	5.75 (146.1)	YS2072	LT2072S or F	EZB2072R	EZT2072S or F
Main breaker with 100 A through-feed lugs or sub-feed breaker	EHD, FDB, FD, FDE, HFD, FDC, HFDE, FDCE (V)	EHD, FDB, FD, FDE, HFD, FDC, HFDE, FDCE (V)	—	18	48.00 (1219.2)	20.00 (508.0)	5.75 (146.1)	YS2048	LT2048S or F	EZB2048R	EZT2048S or F
				30	48.00 (1219.2)	20.00 (508.0)	5.75 (146.1)	YS2048	LT2048S or F	EZB2048R	EZT2048S or F
				42	60.00 (1524.0)	20.00 (508.0)	5.75 (146.1)	YS2060	LT2060S or F	EZB2060R	EZT2060S or F
				48	60.00 (1524.0)	20.00 (508.0)	5.75 (146.1)	YS2060	LT2060S or F	EZB2060R	EZT2060S or F
	—	—	—	54	72.00 (1828.8)	20.00 (508.0)	5.75 (146.1)	YS2072	LT2072S or F	EZB2072R	EZT2072S or F
				60	72.00 (1828.8)	20.00 (508.0)	5.75 (146.1)	YS2072	LT2072S or F	EZB2072R	EZT2072S or F
				72	72.00 (1828.8)	20.00 (508.0)	5.75 (146.1)	YS2072	LT2072S or F	EZB2072R	EZT2072S or F
				84	72.00 (1828.8)	20.00 (508.0)	5.75 (146.1)	YS2072	LT2072S or F	EZB2072R	EZT2072S or F
225A											
Main lugs ^④	—	—	—	18	36.00 (914.4)	20.00 (508.0)	5.75 (146.1)	YS2036	LT2036S or F	EZB2036R	EZT2036S or F
				30	36.00 (914.4)	20.00 (508.0)	5.75 (146.1)	YS2036	LT2036S or F	EZB2036R	EZT2036S or F
				42	48.00 (1219.2)	20.00 (508.0)	5.75 (146.1)	YS2048	LT2048S or F	EZB2048R	EZT2048S or F
				48	48.00 (1219.2)	20.00 (508.0)	5.75 (146.1)	YS2048	LT2048S or F	EZB2048R	EZT2048S or F
	—	—	—	54	48.00 (1219.2)	20.00 (508.0)	5.75 (146.1)	YS2048	LT2048S or F	EZB2048R	EZT2048S or F
				60	60.00 (1524.0)	20.00 (508.0)	5.75 (146.1)	YS2060	LT2060S or F	EZB2060R	EZT2060S or F
				72	60.00 (1524.0)	20.00 (508.0)	5.75 (146.1)	YS2060	LT2060S or F	EZB2060R	EZT2060S or F
				84	72.00 (1828.8)	20.00 (508.0)	5.75 (146.1)	YS2072	LT2072S or F	EZB2072R	EZT2072S or F
Main breaker ^④	EDB, EDS, ED, EDH, EDC, FD, HFD, FDC, FDE, HFDE, FDCE (V)	—	—	18	36.00 (914.4)	20.00 (508.0)	5.75 (146.1)	YS2036	LT2036S or F	EZB2036R	EZT2036S or F
				30	48.00 (1219.2)	20.00 (508.0)	5.75 (146.1)	YS2048	LT2048S or F	EZB2048R	EZT2048S or F
				42	48.00 (1219.2)	20.00 (508.0)	5.75 (146.1)	YS2048	LT2048S or F	EZB2048R	EZT2048S or F
				48	60.00 (1524.0)	20.00 (508.0)	5.75 (146.1)	YS2060	LT2060S or F	EZB2060R	EZT2060S or F
	—	—	—	54	60.00 (1524.0)	20.00 (508.0)	5.75 (146.1)	YS2060	LT2060S or F	EZB2060R	EZT2060S or F
				60	60.00 (1524.0)	20.00 (508.0)	5.75 (146.1)	YS2060	LT2060S or F	EZB2060R	EZT2060S or F
				72	72.00 (1828.8)	20.00 (508.0)	5.75 (146.1)	YS2072	LT2072S or F	EZB2072R	EZT2072S or F
				84	72.00 (1828.8)	20.00 (508.0)	5.75 (146.1)	YS2072	LT2072S or F	EZB2072R	EZT2072S or F

① Smaller panelboard box sizes are available if required. Contact Eaton for application information.

② Add 8.00 inches (203.2 mm) for SPD.

③ 28.00 inches (711.2 mm) optional width is available for panelboards with high circuit counts.

④ JD, HJD, JDC is same space requirement as 400 A DK, HKD, KDC.

Technical Data and Specifications—Pow-R-Line 1a

Table 22.1-6. Type 1 Panelboards—Dimensions in Inches (mm) (Continued)

Panelboard Types	Types and Mounting Position (H) = Horizontal / (V) = Vertical			Maximum Number of Branch Circuits Including Provisions	Box Dimensions ^{①②③}			Catalog Number			
	Main Breaker	Sub-Feed Breaker	Dual Sub-Feed Breaker		Height	Width	Depth	YS Box	LT Trim	EZ Box	EZ Trim
225 A (Continued)											
Main lugs with 225 A through-feed lugs or sub-feed breaker ^④	—	EDB, EDS, ED, EDH, EDC, FD, HFD, FDC, FDE, HFDE, FDCE (V)	—	18	36.00 (914.4)	20.00 (508.0)	5.75 (146.1)	YS2036	LT2036S or F	EZB2036R	EZT2036S or F
				30	48.00 (1219.2)	20.00 (508.0)	5.75 (146.1)	YS2048	LT2048S or F	EZB2048R	EZT2048S or F
				42	48.00 (1219.2)	20.00 (508.0)	5.75 (146.1)	YS2048	LT2048S or F	EZB2048R	EZT2048S or F
				48	60.00 (1524.0)	20.00 (508.0)	5.75 (146.1)	YS2060	LT2060S or F	EZB2060R	EZT2060S or F
	—	—	—	54	60.00 (1524.0)	20.00 (508.0)	5.75 (146.1)	YS2060	LT2060S or F	EZB2060R	EZT2060S or F
				60	60.00 (1524.0)	20.00 (508.0)	5.75 (146.1)	YS2060	LT2060S or F	EZB2060R	EZT2060S or F
				72	72.00 (1828.8)	20.00 (508.0)	5.75 (146.1)	YS2072	LT2072S or F	EZB2072R	EZT2072S or F
				84	72.00 (1828.8)	20.00 (508.0)	5.75 (146.1)	YS2072	LT2072S or F	EZB2072R	EZT2072S or F
Main breaker with 225 A through-feed lugs or sub-feed breaker ^④	EDB, EDS, ED, EDH, EDC, FD, HFD, FDC, FDE, HFDE, FDCE (V)	EDB, EDS, ED, EDH, EDC, FD, HFD, FDC, FDE, HFDE, FDCE (V)	—	18	48.00 (1219.2)	20.00 (508.0)	5.75 (146.1)	YS2048	LT2048S or F	EZB2048R	EZT2048S or F
				30	48.00 (1219.2)	20.00 (508.0)	5.75 (146.1)	YS2048	LT2048S or F	EZB2048R	EZT2048S or F
				42	60.00 (1524.0)	20.00 (508.0)	5.75 (146.1)	YS2060	LT2060S or F	EZB2060R	EZT2060S or F
				48	60.00 (1524.0)	20.00 (508.0)	5.75 (146.1)	YS2060	LT2060S or F	EZB2060R	EZT2060S or F
	—	—	—	54	72.00 (1828.8)	20.00 (508.0)	5.75 (146.1)	YS2072	LT2072S or F	EZB2072R	EZT2072S or F
				60	72.00 (1828.8)	20.00 (508.0)	5.75 (146.1)	YS2072	LT2072S or F	EZB2072R	EZT2072S or F
				72	72.00 (1828.8)	20.00 (508.0)	5.75 (146.1)	YS2072	LT2072S or F	EZB2072R	EZT2072S or F
				72	72.00 (1828.8)	20.00 (508.0)	5.75 (146.1)	YS2072	LT2072S or F	EZB2072R	EZT2072S or F
Main lugs with 225 A dual sub-feed breaker ^④	—	—	EDB, EDS, ED, EDH, EDC, FD, HFD, FDC, FDE, HFDE, FDCE (V)	18	48.00 (1219.2)	20.00 (508.0)	5.75 (146.1)	YS2048	LT2048S or F	EZB2048R	EZT2048S or F
				30	60.00 (1524.0)	20.00 (508.0)	5.75 (146.1)	YS2060	LT2060S or F	EZB2060R	EZT2060S or F
				42	60.00 (1524.0)	20.00 (508.0)	5.75 (146.1)	YS2060	LT2060S or F	EZB2060R	EZT2060S or F
				48	72.00 (1828.8)	20.00 (508.0)	5.75 (146.1)	YS2072	LT2072S or F	EZB2072R	EZT2072S or F
	—	—	—	54	72.00 (1828.8)	20.00 (508.0)	5.75 (146.1)	YS2072	LT2072S or F	EZB2072R	EZT2072S or F
				60	72.00 (1828.8)	20.00 (508.0)	5.75 (146.1)	YS2072	LT2072S or F	EZB2072R	EZT2072S or F
				72	90.00 (2286.0)	20.00 (508.0)	5.75 (146.1)	YS2090	LT2090S or F	EZB2090R	EZT2090S or F
				84	90.00 (2286.0)	20.00 (508.0)	5.75 (146.1)	YS2090	LT2090S or F	EZB2090R	EZT2090S or F
Main breaker with 225 A dual sub-feed breakers ^④	EDB, EDS, ED, EDH, EDC, FD, HFD, FDC, FDE, HFDE, FDCE (V)	—	EDB, EDS, ED, EDH, EDC, FD, HFD, FDC, FDE, HFDE, FDCE (V)	18	60.00 (1524.0)	20.00 (508.0)	5.75 (146.1)	YS2060	LT2060S or F	EZB2060R	EZT2060S or F
				30	60.00 (1524.0)	20.00 (508.0)	5.75 (146.1)	YS2060	LT2060S or F	EZB2060R	EZT2060S or F
				42	72.00 (1828.8)	20.00 (508.0)	5.75 (146.1)	YS2072	LT2072S or F	EZB2072R	EZT2072S or F
				48	72.00 (1828.8)	20.00 (508.0)	5.75 (146.1)	YS2072	LT2072S or F	EZB2072R	EZT2072S or F
	—	—	—	54	72.00 (1828.8)	20.00 (508.0)	5.75 (146.1)	YS2072	LT2072S or F	EZB2072R	EZT2072S or F
				54	72.00 (1828.8)	20.00 (508.0)	5.75 (146.1)	YS2072	LT2072S or F	EZB2072R	EZT2072S or F
				72	90.00 (2286.0)	20.00 (508.0)	5.75 (146.1)	YS2090	LT2090S or F	EZB2090R	EZT2090S or F
				84	90.00 (2286.0)	20.00 (508.0)	5.75 (146.1)	YS2090	LT2090S or F	EZB2090R	EZT2090S or F
400 A											
Main lugs	—	—	—	18	48.00 (1219.2)	20.00 (508.0)	5.75 (146.1)	YS2048	LT2048S or F	EZB2048R	EZT2048S or F
				30	48.00 (1219.2)	20.00 (508.0)	5.75 (146.1)	YS2048	LT2048S or F	EZB2048R	EZT2048S or F
				42	60.00 (1524.0)	20.00 (508.0)	5.75 (146.1)	YS2060	LT2060S or F	EZB2060R	EZT2060S or F
				48	60.00 (1524.0)	20.00 (508.0)	5.75 (146.1)	YS2060	LT2060S or F	EZB2060R	EZT2060S or F
	—	—	—	54	60.00 (1524.0)	20.00 (508.0)	5.75 (146.1)	YS2060	LT2060S or F	EZB2060R	EZT2060S or F
				60	60.00 (1524.0)	20.00 (508.0)	5.75 (146.1)	YS2060	LT2060S or F	EZB2060R	EZT2060S or F
				72	72.00 (1828.8)	20.00 (508.0)	5.75 (146.1)	YS2072	LT2072S or F	EZB2072R	EZT2072S or F
				84	90.00 (2286.0)	20.00 (508.0)	5.75 (146.1)	YS2090	LT2090S or F	EZB2090R	EZT2090S or F
Main breaker	DK, KD, HKD, KDC, LHH (V)	—	—	18	48.00 (1219.2)	20.00 (508.0)	5.75 (146.1)	YS2048	LT2048S or F	EZB2048R	EZT2048S or F
				30	60.00 (1524.0)	20.00 (508.0)	5.75 (146.1)	YS2060	LT2060S or F	EZB2060R	EZT2060S or F
				42	60.00 (1524.0)	20.00 (508.0)	5.75 (146.1)	YS2060	LT2060S or F	EZB2060R	EZT2060S or F
				48	72.00 (1828.8)	20.00 (508.0)	5.75 (146.1)	YS2072	LT2072S or F	EZB2072R	EZT2072S or F
	—	—	—	54	72.00 (1828.8)	20.00 (508.0)	5.75 (146.1)	YS2072	LT2072S or F	EZB2072R	EZT2072S or F
				60	72.00 (1828.8)	20.00 (508.0)	5.75 (146.1)	YS2072	LT2072S or F	EZB2072R	EZT2072S or F
				72	90.00 (2286.0)	20.00 (508.0)	5.75 (146.1)	YS2090	LT2090S or F	EZB2090R	EZT2090S or F
				84	90.00 (2286.0)	20.00 (508.0)	5.75 (146.1)	YS2090	LT2090S or F	EZB2090R	EZT2090S or F
Main lugs with through-feed lugs	—	—	—	18	48.00 (1219.2)	20.00 (508.0)	5.75 (146.1)	YS2048	LT2048S or F	EZB2048R	EZT2048S or F
				30	60.00 (1524.0)	20.00 (508.0)	5.75 (146.1)	YS2060	LT2060S or F	EZB2060R	EZT2060S or F
				42	60.00 (1524.0)	20.00 (508.0)	5.75 (146.1)	YS2060	LT2060S or F	EZB2060R	EZT2060S or F
				48	72.00 (1828.8)	20.00 (508.0)	5.75 (146.1)	YS2072	LT2072S or F	EZB2072R	EZT2072S or F
	—	—	—	54	72.00 (1828.8)	20.00 (508.0)	5.75 (146.1)	YS2072	LT2072S or F	EZB2072R	EZT2072S or F
				60	72.00 (1828.8)	20.00 (508.0)	5.75 (146.1)	YS2072	LT2072S or F	EZB2072R	EZT2072S or F
				72	90.00 (2286.0)	20.00 (508.0)	5.75 (146.1)	YS2090	LT2090S or F	EZB2090R	EZT2090S or F
				84	90.00 (2286.0)	20.00 (508.0)	5.75 (146.1)	YS2090	LT2090S or F	EZB2090R	EZT2090S or F

① Smaller panelboard box sizes are available if required. Contact Eaton for application information.

② Add 8.00 inches (203.2 mm) for SPD.

③ 28.00 inches (711.2 mm) optional width is available for panelboards with high circuit counts.

④ JD, HJD, JDC is same space requirement as 400 A DK, HKD, KDC.

Table 22.1-6. Type 1 Panelboards—Dimensions in Inches (mm) (Continued)

Panelboard Types	Types and Mounting Position (H) = Horizontal / (V) = Vertical			Maximum Number of Branch Circuits Including Provisions	Box Dimensions ^{①②③}			Catalog Number			
	Main Breaker	Sub-Feed Breaker	Dual Sub-Feed Breaker		Height	Width	Depth	YS Box	LT Trim	EZ Box	EZ Trim
400 A (Continued)											
Main breaker with through-feed lugs	DK, KD, HKD, KDC, LHH (V)	—	—	18	60.00 (1524.0)	20.00 (508.0)	5.75 (146.1)	YS2060	LT2060S or F	EZB2060R	EZT2060S or F
		—	—	30	72.00 (1828.8)	20.00 (508.0)	5.75 (146.1)	YS2072	LT2072S or F	EZB2072R	EZT2072S or F
		—	—	42	72.00 (1828.8)	20.00 (508.0)	5.75 (146.1)	YS2072	LT2072S or F	EZB2072R	EZT2072S or F
		—	—	48	90.00 (2286.0)	20.00 (508.0)	5.75 (146.1)	YS2090	LT2090S or F	EZB2090R	EZT2090S or F
Main lugs with 225 A or 100 A sub-feed breaker or dual sub-feed breaker	—	EDB, EDS, ED, EDH, EDC, FD, HFD, FDC, FDE, HFDE, FDCE (V)	EDB, EDS, ED, EDH, EDC, FD, HFD, FDC, FDE, HFDE, FDCE (V)	18	60.00 (1524.0)	20.00 (508.0)	5.75 (146.1)	YS2060	LT2060S or F	EZB2060R	EZT2060S or F
				30	60.00 (1524.0)	20.00 (508.0)	5.75 (146.1)	YS2060	LT2060S or F	EZB2060R	EZT2060S or F
				42	72.00 (1828.8)	20.00 (508.0)	5.75 (146.1)	YS2072	LT2072S or F	EZB2072R	EZT2072S or F
				48	72.00 (1828.8)	20.00 (508.0)	5.75 (146.1)	YS2072	LT2072S or F	EZB2072R	EZT2072S or F
Main breaker with 225 A or 100 A sub-feed breaker	DK, KD, HKD, KDC, LHH (V)	EDB, EDS, ED, EDH, EDC, FD, HFD, FDC, FDE, HFDE, FDCE (V)	—	18	60.00 (1524.0)	20.00 (508.0)	5.75 (146.1)	YS2060	LT2060S or F	EZB2060R	EZT2060S or F
				30	72.00 (1828.8)	20.00 (508.0)	5.75 (146.1)	YS2072	LT2072S or F	EZB2072R	EZT2072S or F
				42	72.00 (1828.8)	20.00 (508.0)	5.75 (146.1)	YS2072	LT2072S or F	EZB2072R	EZT2072S or F
				48	90.00 (2286.0)	20.00 (508.0)	5.75 (146.1)	YS2090	LT2090S or F	EZB2090R	EZT2090S or F
Main breaker with 225 A or 100 A dual sub-feed breaker	DK, KD, HKD, KDC, LHH (V)	—	EDB, EDS, ED, EDH, EDC, FD, HFD, FDC, FDE, HFDE, FDCE (V)	18	72.00 (1828.8)	20.00 (508.0)	5.75 (146.1)	YS2072	LT2072S or F	EZB2072R	EZT2072S or F
				30	72.00 (1828.8)	20.00 (508.0)	5.75 (146.1)	YS2072	LT2072S or F	EZB2072R	EZT2072S or F
				42	90.00 (2286.0)	20.00 (508.0)	5.75 (146.1)	YS2090	LT2090S or F	EZB2090R	EZT2090S or F
				48	90.00 (2286.0)	20.00 (508.0)	5.75 (146.1)	YS2090	LT2090S or F	EZB2090R	EZT2090S or F
Main lugs with 400 A sub-feed breaker	—	DK, KD, HKD, KDC, LHH (V)	—	18	60.00 (1524.0)	20.00 (508.0)	5.75 (146.1)	YS2060	LT2060S or F	EZB2060R	EZT2060S or F
				30	72.00 (1828.8)	20.00 (508.0)	5.75 (146.1)	YS2072	LT2072S or F	EZB2072R	EZT2072S or F
				42	72.00 (1828.8)	20.00 (508.0)	5.75 (146.1)	YS2072	LT2072S or F	EZB2072R	EZT2072S or F
				48	90.00 (2286.0)	20.00 (508.0)	5.75 (146.1)	YS2090	LT2090S or F	EZB2090R	EZT2090S or F
Main breaker with 400 A sub-feed breaker	DK, KD, HKD, KDC, LHH (V)	DK, KD, HKD, KDC, LHH (V)	—	18	72.00 (1828.8)	20.00 (508.0)	5.75 (146.1)	YS2072	LT2072S or F	EZB2072R	EZT2072S or F
				30	90.00 (2286.0)	20.00 (508.0)	5.75 (146.1)	YS2090	LT2090S or F	EZB2090R	EZT2090S or F
				42	90.00 (2286.0)	20.00 (508.0)	5.75 (146.1)	YS2090	LT2090S or F	EZB2090R	EZT2090S or F
				48	90.00 (2286.0)	20.00 (508.0)	5.75 (146.1)	YS2090	LT2090S or F	EZB2090R	EZT2090S or F
Main lugs	—	—	—	18	48.00 (1219.2)	20.00 (508.0)	5.75 (146.1)	YS2048	LT2048S or F	EZB2048R	EZT2048S or F
				30	48.00 (1219.2)	20.00 (508.0)	5.75 (146.1)	YS2048	LT2048S or F	EZB2048R	EZT2048S or F
				42	60.00 (1524.0)	20.00 (508.0)	5.75 (146.1)	YS2060	LT2060S or F	EZB2060R	EZT2060S or F
				48	60.00 (1524.0)	20.00 (508.0)	5.75 (146.1)	YS2060	LT2060S or F	EZB2060R	EZT2060S or F
				54	60.00 (1524.0)	20.00 (508.0)	5.75 (146.1)	YS2060	LT2060S or F	EZB2060R	EZT2060S or F
				60	60.00 (1524.0)	20.00 (508.0)	5.75 (146.1)	YS2060	LT2060S or F	EZB2060R	EZT2060S or F
				72	72.00 (1828.8)	20.00 (508.0)	5.75 (146.1)	YS2072	LT2072S or F	EZB2072R	EZT2072S or F
				84	90.00 (2286.0)	20.00 (508.0)	5.75 (146.1)	YS2090	LT2090S or F	EZB2090R	EZT2090S or F
Main breaker	LGE, LGH, LGC, LGU (V)	—	—	18	60.00 (1524.0)	20.00 (508.0)	5.75 (146.1)	YS2060	LT2060S or F	EZB2060R	EZT2060S or F
				30	60.00 (1524.0)	20.00 (508.0)	5.75 (146.1)	YS2060	LT2060S or F	EZB2060R	EZT2060S or F
				42	72.00 (1828.8)	20.00 (508.0)	5.75 (146.1)	YS2072	LT2072S or F	EZB2072R	EZT2072S or F
				48	72.00 (1828.8)	20.00 (508.0)	5.75 (146.1)	YS2072	LT2072S or F	EZB2072R	EZT2072S or F
				54	72.00 (1828.8)	20.00 (508.0)	5.75 (146.1)	YS2072	LT2072S or F	EZB2072R	EZT2072S or F
				60	72.00 (1828.8)	20.00 (508.0)	5.75 (146.1)	YS2072	LT2072S or F	EZB2072R	EZT2072S or F
				72	90.00 (2286.0)	20.00 (508.0)	5.75 (146.1)	YS2090	LT2090S or F	EZB2090R	EZT2090S or F
				84	90.00 (2286.0)	20.00 (508.0)	5.75 (146.1)	YS2090	LT2090S or F	EZB2090R	EZT2090S or F

① Smaller panelboard box sizes are available if required. Contact Eaton for application information.
 ② Add 8.00 inches (203.2 mm) for SPD.
 ③ 28.00 inch (711.2 mm) optional width is available for panelboards with high circuit counts.

Technical Data and Specifications—Pow-R-Line 1a

Table 22.1-6. Type 1 Panelboards—Dimensions in Inches (mm) (Continued)

Panelboard Types	Types and Mounting Position (H) = Horizontal / (V) = Vertical			Maximum Number of Branch Circuits Including Provisions	Box Dimensions ①②③			Catalog Number			
	Main Breaker	Sub-Feed Breaker	Dual Sub-Feed Breaker		Height	Width	Depth	YS Box	LT Trim	EZ Box	EZ Trim
600 A (Continued)											
Main lugs with through-feed lugs	—	—	—	18	48.00 (1219.2)	20.00 (508.0)	5.75 (146.1)	YS2048	LT2048S or F	EZB2048R	EZT2048S or F
	—	—	—	30	60.00 (1524.0)	20.00 (508.0)	5.75 (146.1)	YS2060	LT2060S or F	EZB2060R	EZT2060S or F
	—	—	—	42	60.00 (1524.0)	20.00 (508.0)	5.75 (146.1)	YS2060	LT2060S or F	EZB2060R	EZT2060S or F
	—	—	—	48	72.00 (1828.8)	20.00 (508.0)	5.75 (146.1)	YS2072	LT2072S or F	EZB2072R	EZT2072S or F
	—	—	—	54	72.00 (1828.8)	20.00 (508.0)	5.75 (146.1)	YS2072	LT2072S or F	EZB2072R	EZT2072S or F
	—	—	—	60	72.00 (1828.8)	20.00 (508.0)	5.75 (146.1)	YS2072	LT2072S or F	EZB2072R	EZT2072S or F
	—	—	—	72	90.00 (2286.0)	20.00 (508.0)	5.75 (146.1)	YS2090	LT2090S or F	EZB2090R	EZT2090S or F
	—	—	—	84	90.00 (2286.0)	20.00 (508.0)	5.75 (146.1)	YS2090	LT2090S or F	EZB2090R	EZT2090S or F
Main breaker with through-feed lugs	LGE, LGH, LGC, LGU (V)	—	—	18	60.00 (1524.0)	20.00 (508.0)	5.75 (146.1)	YS2060	LT2060S or F	EZB2060R	EZT2060S or F
		—	—	30	72.00 (1828.8)	20.00 (508.0)	5.75 (146.1)	YS2072	LT2072S or F	EZB2072R	EZT2072S or F
		—	—	42	72.00 (1828.8)	20.00 (508.0)	5.75 (146.1)	YS2072	LT2072S or F	EZB2072R	EZT2072S or F
		—	—	48	90.00 (2286.0)	20.00 (508.0)	5.75 (146.1)	YS2090	LT2090S or F	EZB2090R	EZT2090S or F
	—	—	—	54	90.00 (2286.0)	20.00 (508.0)	5.75 (146.1)	YS2090	LT2090S or F	EZB2090R	EZT2090S or F
	—	—	—	60	90.00 (2286.0)	20.00 (508.0)	5.75 (146.1)	YS2090	LT2090S or F	EZB2090R	EZT2090S or F
	—	—	—	72	90.00 (2286.0)	20.00 (508.0)	5.75 (146.1)	YS2090	LT2090S or F	EZB2090R	EZT2090S or F
	—	—	—	72	90.00 (2286.0)	20.00 (508.0)	5.75 (146.1)	YS2090	LT2090S or F	EZB2090R	EZT2090S or F
Main lugs with 225 A or 100 A sub-feed breaker or dual sub-feed breaker	—	EDB, EDS, ED	EDB, EDS, ED, EDH	18	60.00 (1524.0)	20.00 (508.0)	5.75 (146.1)	YS2060	LT2060S or F	EZB2060R	EZT2060S or F
				30	72.00 (1828.8)	20.00 (508.0)	5.75 (146.1)	YS2072	LT2072S or F	EZB2072R	EZT2072S or F
				42	72.00 (1828.8)	20.00 (508.0)	5.75 (146.1)	YS2072	LT2072S or F	EZB2072R	EZT2072S or F
				48	90.00 (2286.0)	20.00 (508.0)	5.75 (146.1)	YS2090	LT2090S or F	EZB2090R	EZT2090S or F
	—	EDH, EDC, FD, HFD, FDC, FDE, HFDE, FDCE (V)	EDC, FD, HFD, FDC, FDE, HFDE, FDCE (V)	54	90.00 (2286.0)	20.00 (508.0)	5.75 (146.1)	YS2090	LT2090S or F	EZB2090R	EZT2090S or F
				60	90.00 (2286.0)	20.00 (508.0)	5.75 (146.1)	YS2090	LT2090S or F	EZB2090R	EZT2090S or F
				72	90.00 (2286.0)	20.00 (508.0)	5.75 (146.1)	YS2090	LT2090S or F	EZB2090R	EZT2090S or F
				72	90.00 (2286.0)	20.00 (508.0)	5.75 (146.1)	YS2090	LT2090S or F	EZB2090R	EZT2090S or F
Main breaker with 225 A or 100 A sub-feed breaker or dual sub-feed breaker	LGE, LGH, LGC, LGU (V)	EDB, EDS, ED, EDH	EDC, FD, HFD, FDC, FDE, HFDE, FDCE (V)	18	72.00 (1828.8)	20.00 (508.0)	5.75 (146.1)	YS2072	LT2072S or F	EZB2072R	EZT2072S or F
				30	90.00 (2286.0)	20.00 (508.0)	5.75 (146.1)	YS2090	LT2090S or F	EZB2090R	EZT2090S or F
				42	90.00 (2286.0)	20.00 (508.0)	5.75 (146.1)	YS2090	LT2090S or F	EZB2090R	EZT2090S or F
				48	90.00 (2286.0)	20.00 (508.0)	5.75 (146.1)	YS2090	LT2090S or F	EZB2090R	EZT2090S or F
	—	EDH, EDC, FD, HFD, FDC, FDE, HFDE, FDCE (V)	EDC, FD, HFD, FDC, FDE, HFDE, FDCE (V)	54	90.00 (2286.0)	20.00 (508.0)	5.75 (146.1)	YS2090	LT2090S or F	EZB2090R	EZT2090S or F
				54	90.00 (2286.0)	20.00 (508.0)	5.75 (146.1)	YS2090	LT2090S or F	EZB2090R	EZT2090S or F
				54	90.00 (2286.0)	20.00 (508.0)	5.75 (146.1)	YS2090	LT2090S or F	EZB2090R	EZT2090S or F
				54	90.00 (2286.0)	20.00 (508.0)	5.75 (146.1)	YS2090	LT2090S or F	EZB2090R	EZT2090S or F
Main lugs with 400 A sub-feed breaker	—	DK, KD, HKD, KDC, LHH (V)	—	18	60.00 (1524.0)	20.00 (508.0)	5.75 (146.1)	YS2060	LT2060S or F	EZB2060R	EZT2060S or F
				30	72.00 (1828.8)	20.00 (508.0)	5.75 (146.1)	YS2072	LT2072S or F	EZB2072R	EZT2072S or F
				42	72.00 (1828.8)	20.00 (508.0)	5.75 (146.1)	YS2072	LT2072S or F	EZB2072R	EZT2072S or F
				48	90.00 (2286.0)	20.00 (508.0)	5.75 (146.1)	YS2090	LT2090S or F	EZB2090R	EZT2090S or F
	—	DK, KD, HKD, KDC, LHH (V)	—	54	90.00 (2286.0)	20.00 (508.0)	5.75 (146.1)	YS2090	LT2090S or F	EZB2090R	EZT2090S or F
				60	90.00 (2286.0)	20.00 (508.0)	5.75 (146.1)	YS2090	LT2090S or F	EZB2090R	EZT2090S or F
				72	90.00 (2286.0)	20.00 (508.0)	5.75 (146.1)	YS2090	LT2090S or F	EZB2090R	EZT2090S or F
				72	90.00 (2286.0)	20.00 (508.0)	5.75 (146.1)	YS2090	LT2090S or F	EZB2090R	EZT2090S or F
Main breaker with 400 A sub-feed breaker	LGE, LGH, LGC, LGU (V)	DK, KD, HKD, KDC, LHH (V)	—	18	72.00 (1828.8)	20.00 (508.0)	5.75 (146.1)	YS2072	LT2072S or F	EZB2072R	EZT2072S or F
				30	90.00 (2286.0)	20.00 (508.0)	5.75 (146.1)	YS2090	LT2090S or F	EZB2090R	EZT2090S or F
				42	90.00 (2286.0)	20.00 (508.0)	5.75 (146.1)	YS2090	LT2090S or F	EZB2090R	EZT2090S or F
				48	90.00 (2286.0)	20.00 (508.0)	5.75 (146.1)	YS2090	LT2090S or F	EZB2090R	EZT2090S or F
	—	DK, KD, HKD, KDC, LHH (V)	—	54	90.00 (2286.0)	20.00 (508.0)	5.75 (146.1)	YS2090	LT2090S or F	EZB2090R	EZT2090S or F
				54	90.00 (2286.0)	20.00 (508.0)	5.75 (146.1)	YS2090	LT2090S or F	EZB2090R	EZT2090S or F
				54	90.00 (2286.0)	20.00 (508.0)	5.75 (146.1)	YS2090	LT2090S or F	EZB2090R	EZT2090S or F
				54	90.00 (2286.0)	20.00 (508.0)	5.75 (146.1)	YS2090	LT2090S or F	EZB2090R	EZT2090S or F
Main lugs with 600 A sub-feed breaker	—	LGE, LGH, LGC, LGU (V)	—	18	60.00 (1524.0)	20.00 (508.0)	5.75 (146.1)	YS2060	LT2060S or F	EZB2060R	EZT2060S or F
				30	72.00 (1828.8)	20.00 (508.0)	5.75 (146.1)	YS2072	LT2072S or F	EZB2072R	EZT2072S or F
				42	72.00 (1828.8)	20.00 (508.0)	5.75 (146.1)	YS2072	LT2072S or F	EZB2072R	EZT2072S or F
				48	90.00 (2286.0)	20.00 (508.0)	5.75 (146.1)	YS2090	LT2090S or F	EZB2090R	EZT2090S or F
	—	LGE, LGH, LGC, LGU (V)	—	54	90.00 (2286.0)	20.00 (508.0)	5.75 (146.1)	YS2090	LT2090S or F	EZB2090R	EZT2090S or F
				60	90.00 (2286.0)	20.00 (508.0)	5.75 (146.1)	YS2090	LT2090S or F	EZB2090R	EZT2090S or F
				72	90.00 (2286.0)	20.00 (508.0)	5.75 (146.1)	YS2090	LT2090S or F	EZB2090R	EZT2090S or F
				72	90.00 (2286.0)	20.00 (508.0)	5.75 (146.1)	YS2090	LT2090S or F	EZB2090R	EZT2090S or F
Main breaker with 600 A sub-feed breaker	LGE, LGH, LGC, LGU (V)	LGE, LGH, LGC, LGU (V)	—	18	72.00 (1828.8)	20.00 (508.0)	5.75 (146.1)	YS2072	LT2072S or F	EZB2072R	EZT2072S or F
				30	90.00 (2286.0)	20.00 (508.0)	5.75 (146.1)	YS2090	LT2090S or F	EZB2090R	EZT2090S or F
				42	90.00 (2286.0)	20.00 (508.0)	5.75 (146.1)	YS2090	LT2090S or F	EZB2090R	EZT2090S or F
				48	90.00 (2286.0)	20.00 (508.0)	5.75 (146.1)	YS2090	LT2090S or F	EZB2090R	EZT2090S or F
	—	LGE, LGH, LGC, LGU (V)	—	54	90.00 (2286.0)	20.00 (508.0)	5.75 (146.1)	YS2090	LT2090S or F	EZB2090R	EZT2090S or F
				54	90.00 (2286.0)	20.00 (508.0)	5.75 (146.1)	YS2090	LT2090S or F	EZB2090R	EZT2090S or F
				54	90.00 (2286.0)	20.00 (508.0)	5.75 (146.1)	YS2090	LT2090S or F	EZB2090R	EZT2090S or F
				54	90.00 (2286.0)	20.00 (508.0)	5.75 (146.1)	YS2090	LT2090S or F	EZB2090R	EZT2090S or F

① Smaller panelboard box sizes are available if required. Contact Eaton for application information.

② Add 8.00 inches (203.2 mm) for SPD.

③ 28.00 inches (711.2 mm) optional width is available for panelboards with high circuit counts.

Pow-R-Line 2a



Pow-R-Line 2a

General Description

Panelboard Ratings

Voltage

- 240 Vac maximum
- 480Y/277 Vac maximum

Note: PRL2a panelboards are suitable for use on three-phase, three-wire applications when derived from a three-phase, four-wire 480Y/277 Vac service where the neutral is not brought to the panelboard. For three-phase, three-wire 480 Vac Delta services use a PRL3a panelboard.

- 250 Vdc maximum

Main Lugs

- 100–600 A

Main Breakers

- 100–600 A

Branch Breakers

- 15–100 A (bolt-on)

Short-Circuit Current Ratings (Symmetrical)

- 240 Vac: 65 kA fully rated
- 240 Vac: 100–200 kA series rated
- 480Y/277 Vac: 14 kA fully rated
- 480Y/277 Vac: 22–150 kA series rated
- 250 Vdc: 10 kA and 14 kA fully rated

Service

- Three-phase, four-wire 208Y/120 V and 240/120 V Delta and 480Y/277 V
- Single-phase, three-wire 120/240 V
- Single-phase, two-wire 120 V
- Three-phase, three-wire 208 and 240 V
- Two-wire 125 Vdc
- Two-wire 250 Vdc

Suitable for service entrance applications when specified.

Mains

For available mains, refer to **Table 22.2-1**.

The GHB main breaker is horizontally mounted, same as branch breakers. All other main breakers are vertically mounted.

Branch Circuits

For available branch devices, refer to **Table 22.2-2**.

Main Lugs Only

The short-circuit rating of the MLO assembled panelboard will be fully rated based upon the lowest rated branch device or may be series rated with an approved upstream device.

Main lugs only ampere ratings: 100, 225 and 400.

Main Circuit Breakers

The short-circuit rating shown is that of the main breaker only. The short circuit rating of the assembled panelboard is the rating of the lowest fully rated main or branch device or the rating of an approved series rated combination.

Table 22.2-1. Main Circuit Breakers

Breaker Frame (Amperes)	Breaker Type	Interrupting Rating (kA Symmetrical)		
		240 Vac	480Y/277 Vac	125/250 Vdc
100	GHB ①	65	14	14
100	EHD	18	14	10
150	FDB	18	14	10
225	FD, FDE	65	35	10
225	HFD, HFDE	100	65	22
225	FDC, FDCE	200	100	22
225	ED	65	—	—
250	EDH	100	—	—
250	EDC	200	—	—
250	JD	65	35	10
250	HJD	100	65	22
250	JDC	200	100	22
400	DK	65	—	10
400	KD	65	35	10
400	HKD	100	65	22
400	LHH	100	65	—
400	KDC	200	100	22
600	LGE	65	35	22
600	LGS	65	50	22
600	LGH	100	65	42
600	LGC, LGU	200	100	42

① For use on 480Y/277 Vac systems only.

Table 22.2-2. Branch Circuit Breakers

Breaker Type	Ampere Rating	Number of Poles	Interrupting Rating (kA Symmetrical)				
			120 Vac	240 Vac	277 Vac	480Y/277 Vac	125/250 Vdc
GHB ②	15–100	1	65	—	14	—	14
GHB ②	15–100	2, 3	—	65	—	14	14
GHQ	15–20	1	65	—	14	—	—
HGHB	15–30	1	65	—	25	—	—
GHORSP ②③	15–20	1, 2	65	65	14	14	—
GHBGFEP	15–60	1	—	—	14	—	—

② For use on 480Y/277 Vac systems only.

③ Solenoid operated breaker.

Series Rated Combinations

Refer to series rating tables beginning on **Page 22.0-14** for the approved series rated combinations available for the branch circuit breakers listed in **Table 22.2-2**.

Technical Data

Bussing

100–400 A: Tin-plated aluminum is standard, copper is available as an option.

Boxes

Boxes are made from code-gauge galvanized steel.

Blank ends are supplied as standard, knockouts are available upon request.

EZ Trim

Trims are made from code-gauge steel and painted ANSI 61 gray.

All panelboards have door-in-door as standard with multi-point catch and lock, and concealed mounting hardware.

Modifications

Table 22.2-3. Sub-Feed Lugs (Main Lugs Only)

Amperes	Panel Height Addition
100	0 Inches (0 mm)
225	0 Inches (0 mm)

Table 22.2-4. Through-Feed Lugs

Amperes	Information
100	See Table 22.2-6
225	See Table 22.2-6
400	See Table 22.2-6
600	See Table 22.2-6

Table 22.2-5. Sub-Feed Breakers (One Per Panel)

Ampere Rating	Breaker Type	Interrupting Rating (kA Symmetrical)	
		240 V	480Y/277 V
150	FDB	18	14
225	FD	65	35
225	HFD	100	65
225	FDC	200	100
225	ED	65	—
225	EDH	100	—
225	EDC	200	—
250	JD	65	35
250	HJD	100	65
250	JDC	200	100
400	KD	65	35
400	HKD	100	65
400	KDC	200	100

Shunt Trips

Shunt trips are available on breakers. GHB breakers with shunt trips require three-pole frame.

Ground Bar

Standard bolted in box. Aluminum is standard. Copper is available as an option.

Enclosures

Types 1, 12, 3R, 4/4X.

Surge Protective Device (SPD)

Integrated onto panelboard chassis. For complete product description and available ratings, refer to **Tab 34**.

Box Sizing and Selection

Box size for all Type 1 panelboards are available from **Table 22.2-6**.

Instructions

- Using description on the required panelboard, select the rating and type of mains required.
- Count total number of branch circuit poles (including spaces) required in the panelboard. Do not count main breaker poles. Convert two- or three-pole branch breakers to single-poles. i.e., three-pole breaker, count as three poles.

Note: For horizontal mounted mains (GHB Type), use main lug table, include space in branch section for mains.

- Using correct table, type of mains and ampere rating per Step 1, find total number of poles.

Note: Where total number of poles (Step 2) fall between number in table, use the next higher number.

- Read box size across columns to the right.

Top and Bottom Gutters (minimum)

5.50 inches (139.7 mm).

Side Gutters

20.00-inch (508.0 mm) wide box:
5.50 inches (139.7 mm).

Technical Data—Pow-R-Line 2a

Table 22.2-6. Type 1 Panelboards—Dimensions in Inches (mm)

Panelboard Types	Types and Mounting Position (H) = Horizontal / (V) = Vertical			Maximum Number of Branch Circuits Including Provisions	Box Dimensions in Inches (mm) ①②③			Catalog Number				
	Main Breaker	Sub-Feed Breaker	Dual Sub-Feed Breaker		Height	Width	Depth	YS Box	LT Trim	EZ Box	EZ Trim	
100 A												
Main breaker	GHB (H)	—	—	15	36.00 (914.4)	20.00 (508.0)	5.75 (146.1)	YS2036	LT2036S or F	EZB2036R	EZT2036S or F	
		—	—	27	48.00 (1219.2)	20.00 (508.0)	5.75 (146.1)	YS2048	LT2048S or F	EZB2048R	EZT2048S or F	
		—	—	39	48.00 (1219.2)	20.00 (508.0)	5.75 (146.1)	YS2048	LT2048S or F	EZB2048R	EZT2048S or F	
		—	—	42	60.00 (1524.0)	20.00 (508.0)	5.75 (146.1)	YS2060	LT2060S or F	EZB2060R	EZT2060S or F	
Main lugs	—	—	—	18	36.00 (914.4)	20.00 (508.0)	5.75 (146.1)	YS2036	LT2036S or F	EZB2036R	EZT2036S or F	
				30	36.00 (914.4)	20.00 (508.0)	5.75 (146.1)	YS2036	LT2036S or F	EZB2036R	EZT2036S or F	
				42	42.00 (1219.2)	20.00 (508.0)	5.75 (146.1)	YS2042	LT2042S or F	EZB2042R	EZT2042S or F	
				48	48.00 (1219.2)	20.00 (508.0)	5.75 (146.1)	YS2048	LT2048S or F	EZB2048R	EZT2048S or F	
	—	—	—	—	54	48.00 (1219.2)	20.00 (508.0)	5.75 (146.1)	YS2048	LT2048S or F	EZB2048R	EZT2048S or F
					60	60.00 (1524.0)	20.00 (508.0)	5.75 (146.1)	YS2060	LT2060S or F	EZB2060R	EZT2060S or F
					72	60.00 (1524.0)	20.00 (508.0)	5.75 (146.1)	YS2060	LT2060S or F	EZB2060R	EZT2060S or F
					84	72.00 (1828.8)	20.00 (508.0)	5.75 (146.1)	YS2072	LT2072S or F	EZB2072R	EZT2072S or F
Main breaker	EHD, FDB, FD, FDE, HFD, FDC, HFDE, FDCE (V)	—	—	18	36.00 (914.4)	20.00 (508.0)	5.75 (146.1)	YS2036	LT2036S or F	EZB2036R	EZT2036S or F	
				30	42.00 (1219.2)	20.00 (508.0)	5.75 (146.1)	YS2042	LT2042S or F	EZB2042R	EZT2042S or F	
				42	48.00 (1219.2)	20.00 (508.0)	5.75 (146.1)	YS2048	LT2048S or F	EZB2048R	EZT2048S or F	
				48	60.00 (1524.0)	20.00 (508.0)	5.75 (146.1)	YS2060	LT2060S or F	EZB2060R	EZT2060S or F	
	—	—	—	—	54	60.00 (1524.0)	20.00 (508.0)	5.75 (146.1)	YS2060	LT2060S or F	EZB2060R	EZT2060S or F
					60	60.00 (1524.0)	20.00 (508.0)	5.75 (146.1)	YS2060	LT2060S or F	EZB2060R	EZT2060S or F
					72	72.00 (1828.8)	20.00 (508.0)	5.75 (146.1)	YS2072	LT2072S or F	EZB2072R	EZT2072S or F
					84	72.00 (1828.8)	20.00 (508.0)	5.75 (146.1)	YS2072	LT2072S or F	EZB2072R	EZT2072S or F
Main lugs with 100 A through-feed lugs or sub-feed breaker	—	EHD, FDB, FD, FDE, HFD, FDC, HFDE, FDCE (V)	—	18	48.00 (1219.2)	20.00 (508.0)	5.75 (146.1)	YS2048	LT2048S or F	EZB2048R	EZT2048S or F	
				30	48.00 (1219.2)	20.00 (508.0)	5.75 (146.1)	YS2048	LT2048S or F	EZB2048R	EZT2048S or F	
				42	60.00 (1524.0)	20.00 (508.0)	5.75 (146.1)	YS2060	LT2060S or F	EZB2060R	EZT2060S or F	
				48	60.00 (1524.0)	20.00 (508.0)	5.75 (146.1)	YS2060	LT2060S or F	EZB2060R	EZT2060S or F	
	—	—	—	—	54	60.00 (1524.0)	20.00 (508.0)	5.75 (146.1)	YS2060	LT2060S or F	EZB2060R	EZT2060S or F
					60	60.00 (1524.0)	20.00 (508.0)	5.75 (146.1)	YS2060	LT2060S or F	EZB2060R	EZT2060S or F
					72	72.00 (1828.8)	20.00 (508.0)	5.75 (146.1)	YS2072	LT2072S or F	EZB2072R	EZT2072S or F
					84	72.00 (1828.8)	20.00 (508.0)	5.75 (146.1)	YS2072	LT2072S or F	EZB2072R	EZT2072S or F
Main breaker with 100 A through-feed lugs or sub-feed breaker	EHD, FDB, FD, FDE, HFD, FDC, HFDE, FDCE (V)	EHD, FDB, FD, FDE, HFD, FDC, HFDE, FDCE (V)	—	18	48.00 (1219.2)	20.00 (508.0)	5.75 (146.1)	YS2048	LT2048S or F	EZB2048R	EZT2048S or F	
				30	48.00 (1219.2)	20.00 (508.0)	5.75 (146.1)	YS2048	LT2048S or F	EZB2048R	EZT2048S or F	
				42	60.00 (1524.0)	20.00 (508.0)	5.75 (146.1)	YS2060	LT2060S or F	EZB2060R	EZT2060S or F	
				48	60.00 (1524.0)	20.00 (508.0)	5.75 (146.1)	YS2060	LT2060S or F	EZB2060R	EZT2060S or F	
	—	—	—	—	54	72.00 (1828.8)	20.00 (508.0)	5.75 (146.1)	YS2072	LT2072S or F	EZB2072R	EZT2072S or F
					60	72.00 (1828.8)	20.00 (508.0)	5.75 (146.1)	YS2072	LT2072S or F	EZB2072R	EZT2072S or F
					72	72.00 (1828.8)	20.00 (508.0)	5.75 (146.1)	YS2072	LT2072S or F	EZB2072R	EZT2072S or F
					72	72.00 (1828.8)	20.00 (508.0)	5.75 (146.1)	YS2072	LT2072S or F	EZB2072R	EZT2072S or F
225 A												
Main lugs ④	—	—	—	18	36.00 (914.4)	20.00 (508.0)	5.75 (146.1)	YS2036	LT2036S or F	EZB2036R	EZT2036S or F	
				30	36.00 (914.4)	20.00 (508.0)	5.75 (146.1)	YS2036	LT2036S or F	EZB2036R	EZT2036S or F	
				42	42.00 (1219.2)	20.00 (508.0)	5.75 (146.1)	YS2042	LT2042S or F	EZB2042R	EZT2042S or F	
				48	48.00 (1219.2)	20.00 (508.0)	5.75 (146.1)	YS2048	LT2048S or F	EZB2048R	EZT2048S or F	
	—	—	—	—	54	48.00 (1219.2)	20.00 (508.0)	5.75 (146.1)	YS2048	LT2048S or F	EZB2048R	EZT2048S or F
					60	60.00 (1524.0)	20.00 (508.0)	5.75 (146.1)	YS2060	LT2060S or F	EZB2060R	EZT2060S or F
					72	60.00 (1524.0)	20.00 (508.0)	5.75 (146.1)	YS2060	LT2060S or F	EZB2060R	EZT2060S or F
					84	72.00 (1828.8)	20.00 (508.0)	5.75 (146.1)	YS2072	LT2072S or F	EZB2072R	EZT2072S or F
Main breaker ④	EHD, FDB, FD, FDE, HFD, FDC, HFDE, FDCE (V)	—	—	18	36.00 (914.4)	20.00 (508.0)	5.75 (146.1)	YS2036	LT2036S or F	EZB2036R	EZT2036S or F	
				30	42.00 (1219.2)	20.00 (508.0)	5.75 (146.1)	YS2042	LT2042S or F	EZB2042R	EZT2042S or F	
				42	48.00 (1219.2)	20.00 (508.0)	5.75 (146.1)	YS2048	LT2048S or F	EZB2048R	EZT2048S or F	
				48	60.00 (1524.0)	20.00 (508.0)	5.75 (146.1)	YS2060	LT2060S or F	EZB2060R	EZT2060S or F	
	—	—	—	—	54	60.00 (1524.0)	20.00 (508.0)	5.75 (146.1)	YS2060	LT2060S or F	EZB2060R	EZT2060S or F
					60	60.00 (1524.0)	20.00 (508.0)	5.75 (146.1)	YS2060	LT2060S or F	EZB2060R	EZT2060S or F
					72	72.00 (1828.8)	20.00 (508.0)	5.75 (146.1)	YS2072	LT2072S or F	EZB2072R	EZT2072S or F
					84	72.00 (1828.8)	20.00 (508.0)	5.75 (146.1)	YS2072	LT2072S or F	EZB2072R	EZT2072S or F

① Smaller panelboard box sizes are available if required. Contact Eaton for application information.
 ② Add 8.00 inches (203.2 mm) for SPD and metering.
 ③ 28.00 inches (711.2 mm) optional width is available for panelboards with high circuit counts.
 ④ JD, HJD, JDC is same space requirement as 400 A DK, HKD, KDC.

Technical Data—Pow-R-Line 2a

Table 22.2-6. Type 1 Panelboards—Dimensions in Inches (mm) (Continued)

Panelboard Types	Types and Mounting Position (H) = Horizontal / (V) = Vertical			Maximum Number of Branch Circuits Including Provisions	Box Dimensions in Inches (mm) ①②③			Catalog Number			
	Main Breaker	Sub-Feed Breaker	Dual Sub-Feed Breaker		Height	Width	Depth	YS Box	LT Trim	EZ Box	EZ Trim
225 A											
Main lugs with 225 A through-feed lugs or sub-feed breaker ④	—	EHD, FDB, FD, FDE HFD, FDC, HFDE, FDCE (V)	—	18	42.00 (1219.2)	20.00 (508.0)	5.75 (146.1)	YS2042	LT2042S or F	EZB2042R	EZT2042S or F
				30	48.00 (1219.2)	20.00 (508.0)	5.75 (146.1)	YS2048	LT2048S or F	EZB2048R	EZT2048S or F
				42	60.00 (1524.0)	20.00 (508.0)	5.75 (146.1)	YS2060	LT2060S or F	EZB2060R	EZT2060S or F
				48	60.00 (1524.0)	20.00 (508.0)	5.75 (146.1)	YS2060	LT2060S or F	EZB2060R	EZT2060S or F
	—	—	—	54	60.00 (1524.0)	20.00 (508.0)	5.75 (146.1)	YS2060	LT2060S or F	EZB2060R	EZT2060S or F
				60	60.00 (1524.0)	20.00 (508.0)	5.75 (146.1)	YS2060	LT2060S or F	EZB2060R	EZT2060S or F
				72	72.00 (1828.8)	20.00 (508.0)	5.75 (146.1)	YS2072	LT2072S or F	EZB2072R	EZT2072S or F
				84	72.00 (1828.8)	20.00 (508.0)	5.75 (146.1)	YS2072	LT2072S or F	EZB2072R	EZT2072S or F
Main breaker with 225 A through-feed lugs or sub-feed breaker ④	EHD, FDB, FD, FDE HFD, FDC, HFDE, FDCE (V)	EHD, FDB, FD, FDE HFD, FDC, HFDE, FDCE (V)	—	18	42.00 (1219.2)	20.00 (508.0)	5.75 (146.1)	YS2042	LT2042S or F	EZB2042R	EZT2042S or F
				30	48.00 (1219.2)	20.00 (508.0)	5.75 (146.1)	YS2048	LT2048S or F	EZB2048R	EZT2048S or F
				42	60.00 (1524.0)	20.00 (508.0)	5.75 (146.1)	YS2060	LT2060S or F	EZB2060R	EZT2060S or F
				48	60.00 (1524.0)	20.00 (508.0)	5.75 (146.1)	YS2060	LT2060S or F	EZB2060R	EZT2060S or F
	—	—	—	54	72.00 (1828.8)	20.00 (508.0)	5.75 (146.1)	YS2072	LT2072S or F	EZB2072R	EZT2072S or F
				60	72.00 (1828.8)	20.00 (508.0)	5.75 (146.1)	YS2072	LT2072S or F	EZB2072R	EZT2072S or F
				72	72.00 (1828.8)	20.00 (508.0)	5.75 (146.1)	YS2072	LT2072S or F	EZB2072R	EZT2072S or F
				72	72.00 (1828.8)	20.00 (508.0)	5.75 (146.1)	YS2072	LT2072S or F	EZB2072R	EZT2072S or F
Main lugs with 225 A dual sub-feed breaker ④	—	—	EHD, FDB, FD, FDE HFD, FDC, HFDE, FDCE (V)	18	48.00 (1219.2)	20.00 (508.0)	5.75 (146.1)	YS2048	LT2048S or F	EZB2048R	EZT2048S or F
				30	60.00 (1524.0)	20.00 (508.0)	5.75 (146.1)	YS2060	LT2060S or F	EZB2060R	EZT2060S or F
				42	60.00 (1524.0)	20.00 (508.0)	5.75 (146.1)	YS2060	LT2060S or F	EZB2060R	EZT2060S or F
				48	72.00 (1828.8)	20.00 (508.0)	5.75 (146.1)	YS2072	LT2072S or F	EZB2072R	EZT2072S or F
	—	—	—	54	72.00 (1828.8)	20.00 (508.0)	5.75 (146.1)	YS2072	LT2072S or F	EZB2072R	EZT2072S or F
				60	72.00 (1828.8)	20.00 (508.0)	5.75 (146.1)	YS2072	LT2072S or F	EZB2072R	EZT2072S or F
				72	90.00 (2286.0)	20.00 (508.0)	5.75 (146.1)	YS2090	LT2090S or F	EZB2090R	EZT2090S or F
				84	90.00 (2286.0)	20.00 (508.0)	5.75 (146.1)	YS2090	LT2090S or F	EZB2090R	EZT2090S or F
Main breaker with 225 A dual sub-feed breakers ④	EHD, FDB, FD, FDE HFD, FDC, HFDE, FDCE (V)	—	EHD, FDB, FD, FDE HFD, FDC, HFDE, FDCE (V)	18	60.00 (1524.0)	20.00 (508.0)	5.75 (146.1)	YS2060	LT2060S or F	EZB2060R	EZT2060S or F
				30	60.00 (1524.0)	20.00 (508.0)	5.75 (146.1)	YS2060	LT2060S or F	EZB2060R	EZT2060S or F
				42	72.00 (1828.8)	20.00 (508.0)	5.75 (146.1)	YS2072	LT2072S or F	EZB2072R	EZT2072S or F
				48	72.00 (1828.8)	20.00 (508.0)	5.75 (146.1)	YS2072	LT2072S or F	EZB2072R	EZT2072S or F
				54	72.00 (1828.8)	20.00 (508.0)	5.75 (146.1)	YS2072	LT2072S or F	EZB2072R	EZT2072S or F
				54	72.00 (1828.8)	20.00 (508.0)	5.75 (146.1)	YS2072	LT2072S or F	EZB2072R	EZT2072S or F
400 A											
Main lugs	—	—	—	18	42.00 (1219.2)	20.00 (508.0)	5.75 (146.1)	YS2042	LT2042S or F	EZB2042R	EZT2042S or F
				30	48.00 (1219.2)	20.00 (508.0)	5.75 (146.1)	YS2048	LT2048S or F	EZB2048R	EZT2048S or F
				42	60.00 (1524.0)	20.00 (508.0)	5.75 (146.1)	YS2060	LT2060S or F	EZB2060R	EZT2060S or F
				48	60.00 (1524.0)	20.00 (508.0)	5.75 (146.1)	YS2060	LT2060S or F	EZB2060R	EZT2060S or F
	—	—	—	54	60.00 (1524.0)	20.00 (508.0)	5.75 (146.1)	YS2060	LT2060S or F	EZB2060R	EZT2060S or F
				60	60.00 (1524.0)	20.00 (508.0)	5.75 (146.1)	YS2060	LT2060S or F	EZB2060R	EZT2060S or F
				72	72.00 (1828.8)	20.00 (508.0)	5.75 (146.1)	YS2072	LT2072S or F	EZB2072R	EZT2072S or F
				72	72.00 (1828.8)	20.00 (508.0)	5.75 (146.1)	YS2072	LT2072S or F	EZB2072R	EZT2072S or F

① Smaller panelboard box sizes are available if required. Contact Eaton for application information.

② Add 8.00 inches (203.2 mm) for SPD and metering.

③ 28.00 inches (711.2 mm) optional width is available for panelboards with high circuit counts.

④ JD, HJD, JDC is same space requirement as 400 A DK, HKD, KDC.

Table 22.2-6. Type 1 Panelboards—Dimensions in Inches (mm) (Continued)

Panelboard Types	Types and Mounting Position (H) = Horizontal / (V) = Vertical			Maximum Number of Branch Circuits Including Provisions	Box Dimensions in Inches (mm) ①②③			Catalog Number			
	Main Breaker	Sub-Feed Breaker	Dual Sub-Feed Breaker		Height	Width	Depth	YS Box	LT Trim	EZ Box	EZ Trim
400 A (Continued)											
Main breaker	DK, KD, HKD, KDC, LHH (V)	—	—	18	48.00 (1219.2)	20.00 (508.0)	5.75 (146.1)	YS2048	LT2048S or F	EZB2048R	EZT2048S or F
		—	—	30	60.00 (1524.0)	20.00 (508.0)	5.75 (146.1)	YS2060	LT2060S or F	EZB2060R	EZT2060S or F
		—	—	42	60.00 (1524.0)	20.00 (508.0)	5.75 (146.1)	YS2060	LT2060S or F	EZB2060R	EZT2060S or F
		—	—	48	72.00 (1828.8)	20.00 (508.0)	5.75 (146.1)	YS2072	LT2072S or F	EZB2072R	EZT2072S or F
	—	—	—	54	72.00 (1828.8)	20.00 (508.0)	5.75 (146.1)	YS2072	LT2072S or F	EZB2072R	EZT2072S or F
	—	—	—	60	72.00 (1828.8)	20.00 (508.0)	5.75 (146.1)	YS2072	LT2072S or F	EZB2072R	EZT2072S or F
	—	—	—	72	90.00 (2286.0)	20.00 (508.0)	5.75 (146.1)	YS2090	LT2090S or F	EZB2090R	EZT2090S or F
	—	—	—	84	90.00 (2286.0)	20.00 (508.0)	5.75 (146.1)	YS2090	LT2090S or F	EZB2090R	EZT2090S or F
Main lugs with through-feed lugs	—	—	—	18	48.00 (1219.2)	20.00 (508.0)	5.75 (146.1)	YS2048	LT2048S or F	EZB2048R	EZT2048S or F
	—	—	—	30	60.00 (1524.0)	20.00 (508.0)	5.75 (146.1)	YS2060	LT2060S or F	EZB2060R	EZT2060S or F
	—	—	—	42	60.00 (1524.0)	20.00 (508.0)	5.75 (146.1)	YS2060	LT2060S or F	EZB2060R	EZT2060S or F
	—	—	—	48	72.00 (1828.8)	20.00 (508.0)	5.75 (146.1)	YS2072	LT2072S or F	EZB2072R	EZT2072S or F
	—	—	—	54	72.00 (1828.8)	20.00 (508.0)	5.75 (146.1)	YS2072	LT2072S or F	EZB2072R	EZT2072S or F
	—	—	—	60	72.00 (1828.8)	20.00 (508.0)	5.75 (146.1)	YS2072	LT2072S or F	EZB2072R	EZT2072S or F
	—	—	—	72	90.00 (2286.0)	20.00 (508.0)	5.75 (146.1)	YS2090	LT2090S or F	EZB2090R	EZT2090S or F
	—	—	—	84	90.00 (2286.0)	20.00 (508.0)	5.75 (146.1)	YS2090	LT2090S or F	EZB2090R	EZT2090S or F
Main breaker with through-feed lugs	DK, KD, HKD, KDC, LHH (V)	—	—	18	60.00 (1524.0)	20.00 (508.0)	5.75 (146.1)	YS2060	LT2060S or F	EZB2060R	EZT2060S or F
		—	—	30	72.00 (1828.8)	20.00 (508.0)	5.75 (146.1)	YS2072	LT2072S or F	EZB2072R	EZT2072S or F
		—	—	42	72.00 (1828.8)	20.00 (508.0)	5.75 (146.1)	YS2072	LT2072S or F	EZB2072R	EZT2072S or F
		—	—	48	90.00 (2286.0)	20.00 (508.0)	5.75 (146.1)	YS2090	LT2090S or F	EZB2090R	EZT2090S or F
	—	—	—	54	90.00 (2286.0)	20.00 (508.0)	5.75 (146.1)	YS2090	LT2090S or F	EZB2090R	EZT2090S or F
	—	—	—	60	90.00 (2286.0)	20.00 (508.0)	5.75 (146.1)	YS2090	LT2090S or F	EZB2090R	EZT2090S or F
	—	—	—	72	90.00 (2286.0)	20.00 (508.0)	5.75 (146.1)	YS2090	LT2090S or F	EZB2090R	EZT2090S or F
	—	—	—	72	90.00 (2286.0)	20.00 (508.0)	5.75 (146.1)	YS2090	LT2090S or F	EZB2090R	EZT2090S or F
Main lugs with 225 A or 100 A sub-feed breaker or dual sub-feed breaker	—	EHD, FDB, FD, FDE HFD, FDC, HFDE, FDCE (V)	EHD, FDB, FD, FDE HFD, FDC, HFDE, FDCE (V)	18	60.00 (1524.0)	20.00 (508.0)	5.75 (146.1)	YS2060	LT2060S or F	EZB2060R	EZT2060S or F
	30			60.00 (1524.0)	20.00 (508.0)	5.75 (146.1)	YS2060	LT2060S or F	EZB2060R	EZT2060S or F	
	42			72.00 (1828.8)	20.00 (508.0)	5.75 (146.1)	YS2072	LT2072S or F	EZB2072R	EZT2072S or F	
	48			72.00 (1828.8)	20.00 (508.0)	5.75 (146.1)	YS2072	LT2072S or F	EZB2072R	EZT2072S or F	
	—	—	—	54	72.00 (1828.8)	20.00 (508.0)	5.75 (146.1)	YS2072	LT2072S or F	EZB2072R	EZT2072S or F
	—	—	—	60	72.00 (1828.8)	20.00 (508.0)	5.75 (146.1)	YS2072	LT2072S or F	EZB2072R	EZT2072S or F
	—	—	—	72	90.00 (2286.0)	20.00 (508.0)	5.75 (146.1)	YS2090	LT2090S or F	EZB2090R	EZT2090S or F
	—	—	—	84	90.00 (2286.0)	20.00 (508.0)	5.75 (146.1)	YS2090	LT2090S or F	EZB2090R	EZT2090S or F
Main breaker with 225 A or 100 A sub-feed breaker	DK, KD, HKD, KDC, LHH (V)	EHD, FDB, FD, FDE HFD, FDC, HFDE, FDCE (V)	—	18	60.00 (1524.0)	20.00 (508.0)	5.75 (146.1)	YS2060	LT2060S or F	EZB2060R	EZT2060S or F
			—	30	72.00 (1828.8)	20.00 (508.0)	5.75 (146.1)	YS2072	LT2072S or F	EZB2072R	EZT2072S or F
			—	42	72.00 (1828.8)	20.00 (508.0)	5.75 (146.1)	YS2072	LT2072S or F	EZB2072R	EZT2072S or F
			—	48	90.00 (2286.0)	20.00 (508.0)	5.75 (146.1)	YS2090	LT2090S or F	EZB2090R	EZT2090S or F
	—	—	—	54	90.00 (2286.0)	20.00 (508.0)	5.75 (146.1)	YS2090	LT2090S or F	EZB2090R	EZT2090S or F
	—	—	—	60	90.00 (2286.0)	20.00 (508.0)	5.75 (146.1)	YS2090	LT2090S or F	EZB2090R	EZT2090S or F
	—	—	—	72	90.00 (2286.0)	20.00 (508.0)	5.75 (146.1)	YS2090	LT2090S or F	EZB2090R	EZT2090S or F
	—	—	—	72	90.00 (2286.0)	20.00 (508.0)	5.75 (146.1)	YS2090	LT2090S or F	EZB2090R	EZT2090S or F
Main breaker with 225 A or 100 A dual sub-feed breaker	DK, KD, HKD, KDC, LHH (V)	—	EHD, FDB, FD, FDE HFD, FDC, HFDE, FDCE (V)	18	72.00 (1828.8)	20.00 (508.0)	5.75 (146.1)	YS2072	LT2072S or F	EZB2072R	EZT2072S or F
				30	72.00 (1828.8)	20.00 (508.0)	5.75 (146.1)	YS2072	LT2072S or F	EZB2072R	EZT2072S or F
				42	90.00 (2286.0)	20.00 (508.0)	5.75 (146.1)	YS2090	LT2090S or F	EZB2090R	EZT2090S or F
				48	90.00 (2286.0)	20.00 (508.0)	5.75 (146.1)	YS2090	LT2090S or F	EZB2090R	EZT2090S or F
	—	—	—	54	90.00 (2286.0)	20.00 (508.0)	5.75 (146.1)	YS2090	LT2090S or F	EZB2090R	EZT2090S or F
	—	—	—	60	90.00 (2286.0)	20.00 (508.0)	5.75 (146.1)	YS2090	LT2090S or F	EZB2090R	EZT2090S or F
	—	—	—	72	90.00 (2286.0)	20.00 (508.0)	5.75 (146.1)	YS2090	LT2090S or F	EZB2090R	EZT2090S or F
	—	—	—	72	90.00 (2286.0)	20.00 (508.0)	5.75 (146.1)	YS2090	LT2090S or F	EZB2090R	EZT2090S or F
Main lugs with 400 A sub-feed breaker	—	DK, KD, HKD, KDC, LHH (V)	—	18	60.00 (1524.0)	20.00 (508.0)	5.75 (146.1)	YS2060	LT2060S or F	EZB2060R	EZT2060S or F
			—	30	72.00 (1828.8)	20.00 (508.0)	5.75 (146.1)	YS2072	LT2072S or F	EZB2072R	EZT2072S or F
			—	42	72.00 (1828.8)	20.00 (508.0)	5.75 (146.1)	YS2072	LT2072S or F	EZB2072R	EZT2072S or F
			—	48	90.00 (2286.0)	20.00 (508.0)	5.75 (146.1)	YS2090	LT2090S or F	EZB2090R	EZT2090S or F
	—	—	—	54	90.00 (2286.0)	20.00 (508.0)	5.75 (146.1)	YS2090	LT2090S or F	EZB2090R	EZT2090S or F
	—	—	—	60	90.00 (2286.0)	20.00 (508.0)	5.75 (146.1)	YS2090	LT2090S or F	EZB2090R	EZT2090S or F
	—	—	—	72	90.00 (2286.0)	20.00 (508.0)	5.75 (146.1)	YS2090	LT2090S or F	EZB2090R	EZT2090S or F
	—	—	—	72	90.00 (2286.0)	20.00 (508.0)	5.75 (146.1)	YS2090	LT2090S or F	EZB2090R	EZT2090S or F
Main breaker with 400 A sub-feed breaker	DK, KD, HKD, KDC, LHH (V)	DK, KD, HKD, KDC, LHH (V)	—	18	72.00 (1828.8)	20.00 (508.0)	5.75 (146.1)	YS2072	LT2072S or F	EZB2072R	EZT2072S or F
			—	30	90.00 (2286.0)	20.00 (508.0)	5.75 (146.1)	YS2090	LT2090S or F	EZB2090R	EZT2090S or F
			—	42	90.00 (2286.0)	20.00 (508.0)	5.75 (146.1)	YS2090	LT2090S or F	EZB2090R	EZT2090S or F
			—	48	90.00 (2286.0)	20.00 (508.0)	5.75 (146.1)	YS2090	LT2090S or F	EZB2090R	EZT2090S or F
	—	—	—	54	90.00 (2286.0)	20.00 (508.0)	5.75 (146.1)	YS2090	LT2090S or F	EZB2090R	EZT2090S or F
	—	—	—	60	90.00 (2286.0)	20.00 (508.0)	5.75 (146.1)	YS2090	LT2090S or F	EZB2090R	EZT2090S or F
	—	—	—	72	90.00 (2286.0)	20.00 (508.0)	5.75 (146.1)	YS2090	LT2090S or F	EZB2090R	EZT2090S or F
	—	—	—	72	90.00 (2286.0)	20.00 (508.0)	5.75 (146.1)	YS2090	LT2090S or F	EZB2090R	EZT2090S or F

① Smaller panelboard box sizes are available if required. Contact Eaton for application information.
 ② Add 8.00 inches (203.2 mm) for SPD and metering.
 ③ 28.00 inches (711.2 mm) optional width is available for panelboards with high circuit counts.

Technical Data—Pow-R-Line 2a

Table 22.2-6. Type 1 Panelboards—Dimensions in Inches (mm) (Continued)

Panelboard Types	Types and Mounting Position (H) = Horizontal / (V) = Vertical			Maximum Number of Branch Circuits Including Provisions	Box Dimensions in Inches (mm) ①②③			Catalog Number			
	Main Breaker	Sub-Feed Breaker	Dual Sub-Feed Breaker		Height	Width	Depth	YS Box	LT Trim	EZ Box	EZ Trim
600 A											
Main lugs	—	—	—	18	42.00 (1219.2)	20.00 (508.0)	5.75 (146.1)	YS2042	LT2042S or F	EZB2042R	EZT2042S or F
	—	—	—	30	48.00 (1219.2)	20.00 (508.0)	5.75 (146.1)	YS2048	LT2048S or F	EZB2048R	EZT2048S or F
	—	—	—	42	60.00 (1524.0)	20.00 (508.0)	5.75 (146.1)	YS2060	LT2060S or F	EZB2060R	EZT2060S or F
	—	—	—	48	60.00 (1524.0)	20.00 (508.0)	5.75 (146.1)	YS2060	LT2060S or F	EZB2060R	EZT2060S or F
	—	—	—	54	60.00 (1524.0)	20.00 (508.0)	5.75 (146.1)	YS2060	LT2060S or F	EZB2060R	EZT2060S or F
	—	—	—	60	60.00 (1524.0)	20.00 (508.0)	5.75 (146.1)	YS2060	LT2060S or F	EZB2060R	EZT2060S or F
	—	—	—	72	72.00 (1828.8)	20.00 (508.0)	5.75 (146.1)	YS2072	LT2072S or F	EZB2072R	EZT2072S or F
	—	—	—	84	90.00 (2286.0)	20.00 (508.0)	5.75 (146.1)	YS2090	LT2090S or F	EZB2090R	EZT2090S or F
Main breaker	LGE, LGH, LGC, LGU (V)	—	—	18	60.00 (1524.0)	20.00 (508.0)	5.75 (146.1)	YS2060	LT2060S or F	EZB2060R	EZT2060S or F
		—	—	30	60.00 (1524.0)	20.00 (508.0)	5.75 (146.1)	YS2060	LT2060S or F	EZB2060R	EZT2060S or F
		—	—	42	72.00 (1828.8)	20.00 (508.0)	5.75 (146.1)	YS2072	LT2072S or F	EZB2072R	EZT2072S or F
		—	—	48	72.00 (1828.8)	20.00 (508.0)	5.75 (146.1)	YS2072	LT2072S or F	EZB2072R	EZT2072S or F
	—	—	—	54	72.00 (1828.8)	20.00 (508.0)	5.75 (146.1)	YS2072	LT2072S or F	EZB2072R	EZT2072S or F
	—	—	—	60	72.00 (1828.8)	20.00 (508.0)	5.75 (146.1)	YS2072	LT2072S or F	EZB2072R	EZT2072S or F
	—	—	—	72	90.00 (2286.0)	20.00 (508.0)	5.75 (146.1)	YS2090	LT2090S or F	EZB2090R	EZT2090S or F
	—	—	—	84	90.00 (2286.0)	20.00 (508.0)	5.75 (146.1)	YS2090	LT2090S or F	EZB2090R	EZT2090S or F
Main lugs with through-feed lugs	—	—	—	18	48.00 (1219.2)	20.00 (508.0)	5.75 (146.1)	YS2048	LT2048S or F	EZB2048R	EZT2048S or F
	—	—	—	30	60.00 (1524.0)	20.00 (508.0)	5.75 (146.1)	YS2060	LT2060S or F	EZB2060R	EZT2060S or F
	—	—	—	42	60.00 (1524.0)	20.00 (508.0)	5.75 (146.1)	YS2060	LT2060S or F	EZB2060R	EZT2060S or F
	—	—	—	48	72.00 (1828.8)	20.00 (508.0)	5.75 (146.1)	YS2072	LT2072S or F	EZB2072R	EZT2072S or F
	—	—	—	54	72.00 (1828.8)	20.00 (508.0)	5.75 (146.1)	YS2072	LT2072S or F	EZB2072R	EZT2072S or F
	—	—	—	60	72.00 (1828.8)	20.00 (508.0)	5.75 (146.1)	YS2072	LT2072S or F	EZB2072R	EZT2072S or F
	—	—	—	72	90.00 (2286.0)	20.00 (508.0)	5.75 (146.1)	YS2090	LT2090S or F	EZB2090R	EZT2090S or F
	—	—	—	84	90.00 (2286.0)	20.00 (508.0)	5.75 (146.1)	YS2090	LT2090S or F	EZB2090R	EZT2090S or F
Main breaker with through-feed lugs	LGE, LGH, LGC, LGU (V)	—	—	18	60.00 (1524.0)	20.00 (508.0)	5.75 (146.1)	YS2060	LT2060S or F	EZB2060R	EZT2060S or F
		—	—	30	72.00 (1828.8)	20.00 (508.0)	5.75 (146.1)	YS2072	LT2072S or F	EZB2072R	EZT2072S or F
		—	—	42	72.00 (1828.8)	20.00 (508.0)	5.75 (146.1)	YS2072	LT2072S or F	EZB2072R	EZT2072S or F
		—	—	48	90.00 (2286.0)	20.00 (508.0)	5.75 (146.1)	YS2090	LT2090S or F	EZB2090R	EZT2090S or F
	—	—	—	54	90.00 (2286.0)	20.00 (508.0)	5.75 (146.1)	YS2090	LT2090S or F	EZB2090R	EZT2090S or F
	—	—	—	60	90.00 (2286.0)	20.00 (508.0)	5.75 (146.1)	YS2090	LT2090S or F	EZB2090R	EZT2090S or F
	—	—	—	72	90.00 (2286.0)	20.00 (508.0)	5.75 (146.1)	YS2090	LT2090S or F	EZB2090R	EZT2090S or F
	—	—	—	72	90.00 (2286.0)	20.00 (508.0)	5.75 (146.1)	YS2090	LT2090S or F	EZB2090R	EZT2090S or F
Main lugs with 225 A or 100 A sub-feed breaker or dual sub-feed breaker	—	EHD, FDB, FD, FDE HFD, FDC, HFDE, FDCE (V)	EHD, FDB, FD, FDE HFD, FDC, HFDE, FDCE (V)	18	60.00 (1524.0)	20.00 (508.0)	5.75 (146.1)	YS2060	LT2060S or F	EZB2060R	EZT2060S or F
	30			72.00 (1828.8)	20.00 (508.0)	5.75 (146.1)	YS2072	LT2072S or F	EZB2072R	EZT2072S or F	
	42			72.00 (1828.8)	20.00 (508.0)	5.75 (146.1)	YS2072	LT2072S or F	EZB2072R	EZT2072S or F	
	48			90.00 (2286.0)	20.00 (508.0)	5.75 (146.1)	YS2090	LT2090S or F	EZB2090R	EZT2090S or F	
	—	—	—	54	90.00 (2286.0)	20.00 (508.0)	5.75 (146.1)	YS2090	LT2090S or F	EZB2090R	EZT2090S or F
	—	—	—	60	90.00 (2286.0)	20.00 (508.0)	5.75 (146.1)	YS2090	LT2090S or F	EZB2090R	EZT2090S or F
	—	—	—	72	90.00 (2286.0)	20.00 (508.0)	5.75 (146.1)	YS2090	LT2090S or F	EZB2090R	EZT2090S or F
	—	—	—	72	90.00 (2286.0)	20.00 (508.0)	5.75 (146.1)	YS2090	LT2090S or F	EZB2090R	EZT2090S or F
Main lugs with 400 A sub-feed breaker	—	DK, KD, HKD, KDC, LHH (V)	—	18	60.00 (1524.0)	20.00 (508.0)	5.75 (146.1)	YS2060	LT2060S or F	EZB2060R	EZT2060S or F
	30			72.00 (1828.8)	20.00 (508.0)	5.75 (146.1)	YS2072	LT2072S or F	EZB2072R	EZT2072S or F	
	42			72.00 (1828.8)	20.00 (508.0)	5.75 (146.1)	YS2072	LT2072S or F	EZB2072R	EZT2072S or F	
	48			90.00 (2286.0)	20.00 (508.0)	5.75 (146.1)	YS2090	LT2090S or F	EZB2090R	EZT2090S or F	
	—	—	—	54	90.00 (2286.0)	20.00 (508.0)	5.75 (146.1)	YS2090	LT2090S or F	EZB2090R	EZT2090S or F
	—	—	—	60	90.00 (2286.0)	20.00 (508.0)	5.75 (146.1)	YS2090	LT2090S or F	EZB2090R	EZT2090S or F
	—	—	—	72	90.00 (2286.0)	20.00 (508.0)	5.75 (146.1)	YS2090	LT2090S or F	EZB2090R	EZT2090S or F
	—	—	—	72	90.00 (2286.0)	20.00 (508.0)	5.75 (146.1)	YS2090	LT2090S or F	EZB2090R	EZT2090S or F
Main breaker with 400 A sub-feed breaker	LGE, LGH, LGC, LGU (V)	DK, KD, HKD, KDC, LHH (V)	—	18	72.00 (1828.8)	20.00 (508.0)	5.75 (146.1)	YS2072	LT2072S or F	EZB2072R	EZT2072S or F
				30	90.00 (2286.0)	20.00 (508.0)	5.75 (146.1)	YS2090	LT2090S or F	EZB2090R	EZT2090S or F
				42	90.00 (2286.0)	20.00 (508.0)	5.75 (146.1)	YS2090	LT2090S or F	EZB2090R	EZT2090S or F
				48	90.00 (2286.0)	20.00 (508.0)	5.75 (146.1)	YS2090	LT2090S or F	EZB2090R	EZT2090S or F
				54	90.00 (2286.0)	20.00 (508.0)	5.75 (146.1)	YS2090	LT2090S or F	EZB2090R	EZT2090S or F

① Smaller panelboard box sizes are available if required. Contact Eaton for application information.
 ② Add 8.00 inches (203.2 mm) for SPD and metering.
 ③ 28.00 inches (711.2 mm) optional width is available for panelboards with high circuit counts.

Table 22.2-6. Type 1 Panelboards—Dimensions in Inches (mm) (Continued)

Panelboard Types	Types and Mounting Position (H) = Horizontal / (V) = Vertical			Maximum Number of Branch Circuits Including Provisions	Box Dimensions in Inches (mm) ^{①②③}			Catalog Number			
	Main Breaker	Sub-Feed Breaker	Dual Sub-Feed Breaker		Height	Width	Depth	YS Box	LT Trim	EZ Box	EZ Trim
600 A (Continued)											
Main lugs with 600 A sub-feed breaker	—	LGE, LGH, LGC, LGU (V)	—	18	60.00 (1524.0)	20.00 (508.0)	5.75 (146.1)	YS2060	LT2060S or F	EZB2060R	EZT2060S or F
			—	30	72.00 (1828.8)	20.00 (508.0)	5.75 (146.1)	YS2072	LT2072S or F	EZB2072R	EZT2072S or F
			—	42	72.00 (1828.8)	20.00 (508.0)	5.75 (146.1)	YS2072	LT2072S or F	EZB2072R	EZT2072S or F
			—	48	90.00 (2286.0)	20.00 (508.0)	5.75 (146.1)	YS2090	LT2090S or F	EZB2090R	EZT2090S or F
			—	54	90.00 (2286.0)	20.00 (508.0)	5.75 (146.1)	YS2090	LT2090S or F	EZB2090R	EZT2090S or F
			—	60	90.00 (2286.0)	20.00 (508.0)	5.75 (146.1)	YS2090	LT2090S or F	EZB2090R	EZT2090S or F
Main breaker with 600 A sub-feed breaker	LGE, LGH, LGC, LGU (V)	LGE, LGH, LGC, LGU (V)	—	18	72.00 (1828.8)	20.00 (508.0)	5.75 (146.1)	YS2072	LT2072S or F	EZB2072R	EZT2072S or F
			—	30	90.00 (2286.0)	20.00 (508.0)	5.75 (146.1)	YS2090	LT2090S or F	EZB2090R	EZT2090S or F
			—	42	90.00 (2286.0)	20.00 (508.0)	5.75 (146.1)	YS2090	LT2090S or F	EZB2090R	EZT2090S or F
			—	48	90.00 (2286.0)	20.00 (508.0)	5.75 (146.1)	YS2090	LT2090S or F	EZB2090R	EZT2090S or F
			—	54	90.00 (2286.0)	20.00 (508.0)	5.75 (146.1)	YS2090	LT2090S or F	EZB2090R	EZT2090S or F
			—	72	90.00 (2286.0)	20.00 (508.0)	5.75 (146.1)	YS2090	LT2090S or F	EZB2090R	EZT2090S or F

① Smaller panelboard box sizes are available if required. Contact Eaton for application information.

② Add 8.00 inches (203.2 mm) for SPD and metering.

③ 28.00 inches (711.2 mm) optional width is available for panelboards with high circuit counts.

This page intentionally left blank.

Pow-R-Line 3a



Pow-R-Line 3a

General Description

Panelboard Ratings

Voltage

- 240 Vac maximum
- 480 Vac maximum
- 600 Vac maximum
- 250 Vdc maximum

Main Lugs

- 100–800 A

Main Breakers

- 100–600 A

Branches

- 240 Vac 15–225 A
- 480 Vac 15–225 A
- 600 Vac 15–225 A (bolt-on)

Interrupting Capacity (Symmetrical)

- 240 Vac: 10–200 kA fully rated
- 240 Vac: 22–200 kA series rated
- 480 Vac: 14–100 kA fully rated
- 480 Vac: 22–150 kA series rated
- 250 Vdc: 10–22 kA fully rated

Service

- Three-phase, four-wire 208Y/120 V, 240/120 V delta and 480Y/277 V
- Single-phase, three-wire 120/240 V
- Single-phase, two-wire 120 V
- Three-phase, three-wire 240, 480 and 600 V
- Two-wire 125 Vdc
- Two-wire 250 Vdc

Suitable for service entrance applications when specified.

Mains

For available mains, refer to **Table 22.3-1**.

Main breakers, 100, 150 and 225 A, Types EHD, FD, FDE, FDB, HFD, HFDE and FDC may be horizontally mounted, same as branch breakers. All other main breakers are vertically mounted.

Branch Circuits

For available branch devices, refer to **Table 22.3-2**.

Main Lugs Only

The short-circuit rating of the MLO assembled panelboard will be fully rated based upon the lowest rated branch device or may be series rated with an approved upstream device.

Main lugs only ampere ratings: 100, 250, 400, 600 and 800.

Main Circuit Breakers

The short-circuit rating shown is that of the main breaker only. The short-circuit rating of the assembled panelboard is the rating of the lowest fully rated main or branch device, or the rating of an approved series rated combination.

Table 22.3-1. Main Circuit Breakers

Breaker Frame (Amperes)	Breaker Type	Interrupting Rating (kA Symmetrical)			
		240 Vac	480 Vac	600 Vac	250 Vdc
100	EHD	18	14	—	10
100	FCL	200	150	—	—
100	FB-P	200	200	200	①
150	FDB	18	14	14	10
225	FD, FDE	65	35	18	10
225	HFD, HFDE	100	65	25	22
225	FDC, FDCE	200	100	35	22
225	EDB	22	—	—	—
225	EDS	42	—	—	—
225	ED	65	—	—	—
225	EDH	100	—	—	—
225	EDC	200	—	—	—
250	JD	65	35	18	10
250	HJD	100	65	25	22
250	JDC	200	100	35	22
400	DK	65	—	—	10
400	KD	65	35	25	10
400	HKD	100	65	35	22
400	LHH	100	65	—	—
400	KDC	200	100	65	22
400	LCL	200	200	—	—
400	LA-P	200	200	200	①
600	LGE	65	35	18	22
600	LGH	100	65	35	22
400	LGC	200	100	50	42
400	LGU	200	150	65	50
600	LD	65	35	25	22
600	HLD	100	65	35	25
600	LDC	200	100	50	25
600	CLD ②	65	35	25	22
600	CHLD ②	100	65	35	25
600	CLDC ②	200	100	50	25

① 100,000 AIC based on NEMA test procedure.

② 100% rated breaker. Requires copper bus. Not available in Type 12, 4 or 4X enclosure.

Series Rated Combinations

Refer to series rating tables beginning on Page 22.0-14 for the approved series rated combinations available for the branch circuit breakers listed in Table 22.3-2.

Table 22.3-2. Branch Circuit Breakers

Breaker Type	Ampere Rating	Number of Poles	Interrupting Rating (kA Symmetrical) Volts						
			120 Vac	120/240 Vac	240 Vac	480 Vac	600 Vac	125 Vdc	250 Vdc
BAB	15-70	1	10	—	—	—	—	—	—
BAB	15-100	2	—	10	—	—	—	—	—
BAB	15-100	2, 3	—	—	10	—	—	—	—
BAB-D ①	15-60	1, 2	10	10	—	—	—	—	—
BAB-C ②	15-30	1, 2	10	10	—	—	—	—	—
BABRP ③	15-30	1, 2	10	10	—	—	—	—	—
BABRSP ③	15-30	1, 2	10	10	—	—	—	—	—
QBGF, QBGFEP	15-50 ④	1, 2	10	10	—	—	—	—	—
QBCAF ⑤	15-20	1	10	10	—	—	—	—	—
QBHW	15-70	1	22	—	—	—	—	—	—
QBHW	15-100	2	—	22	—	—	—	—	—
QBHW	15-100	2, 3	—	—	22	—	—	—	—
QBHGF, QBHGFEP	15-50 ④	1, 2	22	22	—	—	—	—	—
QBHCAF ⑤	15-20	1	22	22	—	—	—	—	—
GHB ⑥⑦	15-100	1	—	—	65	14	—	14	—
GHB ⑥	15-100	2, 3	—	—	65	14	—	—	14
GHQ ⑥⑦	15-20	1	—	—	65	14	—	—	—
HGHB ⑥⑦	15-30	1	—	—	65	25	—	—	—
GHBGFEP	15-60	1	—	—	65	14	—	14	—
GHQRSP ③⑥⑦	15-20	1, 2	65	65	65	14	—	—	—
EHD ⑦	15-100	1	—	—	14	14	—	10	—
EHD	15-100	2, 3	—	—	18	14	—	—	10
FDB	15-150	2, 3	—	—	18	14	14	—	10
FD ⑦	15-100	1	—	—	65	35	—	10	—
FD, FDE	15-225	2, 3	—	—	65	35	18	—	10
HFD ⑦	15-100	1	—	—	65	65	—	10	—
HFD, HFDE	15-225	2, 3	—	—	100	65	25	—	22
FDC, FDCE	15-225	2, 3	—	—	200	100	35	—	22
EDB	100-225	2, 3	—	—	22	—	—	10	—
EDS	100-225	2, 3	—	—	42	—	—	10	—
ED	100-225	2, 3	—	—	65	—	—	10	—
EDH	100-225	2, 3	—	—	100	—	—	10	—
EDC	100-225	2, 3	—	—	200	—	—	10	—

① HID (High Intensity Discharge) rated breaker.

② Switching neutral breaker. Single-pole device requires two-pole space, two-pole device requires three-pole space.

③ Solenoid operated breaker.

④ 50A is two-pole only.

⑤ Arc fault breaker.

⑥ For use on 480Y/277 Vac systems only.

⑦ Single-pole breaker rated 277 Vac.

Technical Data and Specifications

Bussing

Tin-plated aluminum is standard, copper is available as an option. Density rated bus is also available as an option.

Boxes

Boxes are made from code-gauge galvanized steel.

Blank ends are supplied as standard, knockouts are available upon request.

EZ Trim

Trims are made from code-gauge steel and painted ANSI 61 gray.

All panelboards have door-in-door as standard with multi-point catch and lock, and concealed mounting hardware.

Modifications

Table 22.3-3. Sub-Feed Lugs (Main Lugs Only)

Ampere Rating	Added Panel Height
100	0X
250	1X

Table 22.3-4. Through-Feed Lugs

Ampere Rating	Added Panel Height
100	2X
250	5X
400	8X
600	8X

Note: Sub-feed breakers and through-feed lugs cannot be supplied in the same panel.

Table 22.3-5. Sub-Feed Breakers (One Per Panel)

Ampere Rating	Breaker Type	Interrupting Rating (kA Symmetrical)		Added Panel Height
		240 V	480 V	
225/250	JD	65	35	14X
225/250	HJD	100	65	
225/250	JDC	200	100	
400	KD	65	35	15X
400	HKD	100	65	
400	KDC	200	100	
600	LD	65	35	17X
600	HLD	100	65	
600	LDC	200	100	

Note: Sub-feed breakers and through-feed lugs cannot be supplied in the same panel.

Note: Twin mounted J-Frame sub-feed breakers are available. Requires 20X panel height addition.

Shunt Trips

Shunt trips are available on breakers. BAB and QBHW require one additional pole space for shunt trip, i.e., single-pole is two-pole size, two-pole is three-pole size and three-pole is four-pole size. GHB breakers with shunt trip require three-pole frame.

Remote Control Switches

ASCO 920 can be bus connected and mounted in panel for main or sub-main (split-bus) applications.

Time Clocks

Time clocks are mounted at the top or bottom of the panel, either in extended end gutters or in a separate enclosure under a separate door.

Ground Bar

Standard bolted in box. Aluminum is standard. Copper is available as an option.

Enclosures

Types 12, 3R, 4/4X.

Note: Type 12, 3R, 4/4X enclosures are not available for 800 A applications.

Top and Bottom Gutters (Minimum)

All mains: 5.50 inches (139.7 mm).

Side Gutters (Minimum)

4.00 inches (101.6 mm).

Table 22.3-6. Type 1 Box Sizes—Dimensions in Inches (mm)

Maximum Panel Height X Units	Box Dimensions		
	Height	Width	Depth
100–400 A			
14X	36.00 (914.4)	20.00 (508.0)	5.75 (146.1)
23X	48.00 (1219.2)	20.00 (508.0)	5.75 (146.1)
31X	60.00 (1524.0)	20.00 (508.0)	5.75 (146.1)
40X	72.00 (1828.8)	20.00 (508.0)	5.75 (146.1)
53X	90.00 (2286.0)	20.00 (508.0)	5.75 (146.1)
600–800 A			
23X	48.00 (1219.2)	28.00 (711.2)	5.75 (146.1)
31X	60.00 (1524.0)	28.00 (711.2)	5.75 (146.1)
40X	72.00 (1828.8)	28.00 (711.2)	5.75 (146.1)
53X	90.00 (2286.0)	28.00 (711.2)	5.75 (146.1)

Panel Layout Instructions

1. Select:
 - a. Required mains (lugs or breaker).
 - b. Neutral where required.
 - c. Branch circuits as required.
2. Layout panel as shown in **Table 22.3-7**, using appropriate "X" dimensions.
3. Using total X units (panel height) find box height in inches from **Table 22.3-6**. (When total X units come out to an uneven number, use next highest number, i.e., if total X comes out 25X, use 31X.)

Surge Protective Device (SPD)

Integrated onto panelboard chassis. For complete product description and available ratings, refer to **Tab 34**.

Table 22.3-7. Layout Example

		Poles	} BAB } QBGF } QBHW } QBHGF } QBGFEP } QBCAF } GHB } GHQ } HGHB } QBHGF } QBHCAF } GHBGFEP } GHQRSP
		3X-6 5X-12 8X-18 10X-24 13X-30	
		15X-36 18X-42	
Single-pole	Single-pole	1X	} EHD } FDB } FD, FDE (150 A) } HFD, HFDE maximum) } FDC
Two-pole	Two-pole	2X	
Single-pole	Three-pole	3X	
Two-pole			
Neutral selection ^②		5X 100, 250 A 8X 400, 600, 800 A 11X 800 A with through-feed lug	
Two- and three-pole		2X, EHD, FDB, FD, HFD, FDC, FDE, HFDE 3X, EDB, EDS, ED, EDH, FDE, EDC ^③ , FD, HFD, FDC, HFDE (225 A maximum)	
Main lug section		2X 100 A 5X 250 A 8X 400, 600 A 14X—800 A	
Surge protective device		^④	
Main breaker section	Horizontal mounting	2X two-pole EHD, FDB, FD, HFD, FDC ^⑤ , EDB, EDS, ED, EDH, EDC 3X three-pole EHD, FDB, FD, HFD, FDE, FDC ^⑤ , HFDE, EDB, EDS, ED, EDH, EDC	
	Vertically mounted	7X EHD, FDB, FD, HFD, FDC, EDB, EDS, ED, EDH, EDC, FDE, HFDE 9X FCL, FB-P ^⑥ 14X JD, HJD, JDC 15X DK, KD, HKD, KDC, LHH 17X LD, HLD, LDC, CLD, CHLD, CLDC 18X LGE, LGH, LGC, LGU 21X LCL ^⑦ , LA-P ^{⑥⑦}	

① GHB, GHQ and HGHB breakers cannot be mixed on same connector as BAB, QBHW.
 ② Sizing shown is for 100% rated neutral with mechanical lugs. For 200% rated neutral with mechanical lugs, add 3X. For special lug arrangements, contact Eaton.
 ③ Maximum of six breakers per panel.
 ④ Add 5X for 200 kA maximum SPD.
 ⑤ Horizontally mounted 15–225 A main breakers EHD, FDB, FD, HFD, FDC, may be furnished as branch breaker construction. Branch breakers single-, two- or three-pole as required, may be located opposite these main breakers (150 A maximum).
 ⑥ FB-P and LA-P top mounting only.
 ⑦ LCL, LA-P main breaker requires 6.50 inch (165.1 mm) deep box.

Pow-R-Line 3E



Pow-R-Line 3E

General Description

Panelboard Ratings

Voltage

- 240 Vac maximum
- 480 Vac maximum
- 250 Vdc maximum

Main Lugs

- 100–600 A

Main Breakers

- 100–600 A

Branches

- 240 Vac 15–125 A
- 480 Vac 15–125 A

Interrupting Capacity (Symmetrical)

- 240 Vac: 25–100 kA fully rated
- 240 Vac: 65–100 kA series rated
- 480 Vac: 18–65 kA fully rated
- 480 Vac: 65–100 kA series rated

Service

- Three-phase, four-wire 208Y/120 V, 240/120 V delta and 480Y/277 V
- Single-phase, three-wire 120/240 V
- Single-phase, two-wire 120 V
- Three-phase, three-wire 240 and 480 V
- Two-wire 125 Vdc
- Two-wire 250 Vdc

Suitable for service entrance applications when specified.

Mains

For available mains, refer to **Table 22.3-8**.

Main breakers, 100, 150 and 225 A, Types EG, EHD, FD, FDE, FDB, HFD, HFDE and FDC may be horizontally mounted, same as branch breakers. All other main breakers are vertically mounted.

Branch Circuits

For available branch devices, refer to **Table 22.3-9**.

Main Lugs Only

The short-circuit rating of the MLO assembled panelboard will be fully rated based upon the lowest rated branch device or may be series rated with an approved upstream device.

Main lugs only ampere ratings: 100, 250, 400 and 600.

Main Circuit Breakers

The short-circuit rating shown is that of the main breaker only. The short-circuit rating of the assembled panelboard is the rating of the lowest fully rated main or branch device, or the rating of an approved series rated combination.

Table 22.3-8. Main Circuit Breakers

Breaker Frame (Amperes)	Breaker Type	Interrupting Rating (kA Symmetrical)		
		240 Vac	480 Vac	250 Vdc
125	EGB ①	35	18	10
125	EGS ①	100	35	35
125	EGH ①	200	65	42
225	EDB	22	—	—
225	EDS	42	—	—
225	ED	65	—	—
225	EDH	100	—	—
225	EDC	200	—	—
225	FD, FDE	65	35	10
225	HFD, HFDE	100	65	22
225	FDC	200	100	22
400	DK	65	—	—
400	KD	65	35	10
400	HKD	100	65	22
400	LHH	100	65	—
400	KDC	200	100	22
600	LGE	65	35	22
600	LGH	100	65	22

① Horizontally/branch mounted.

Table 22.3-9. Branch Circuit Breakers

Breaker Type	Ampere Rating	Number of Poles	Interrupting Rating (kA Symmetrical)				
			120 Vac ②	240 Vac	277 Vac ②	480 Vac	250 Vdc
EGB	15–125	1, 2, 3	25	25	18	18	10
EGS	15–125	1, 2, 3	85	85	35	35	35
EGH	15–125	1, 2, 3	100	100	65	65	42

② Applicable to single-pole devices only.

Series Rated Combinations

Refer to series rating tables beginning on **Page 22.0-14** for the approved series rated combinations available for the branch circuit breakers listed in **Table 22.3-9**.

Technical Data and Specifications**Bussing**

100–600 A: Tin-plated aluminum is standard, copper is available as an option.

Boxes

Boxes are made from code-gauge galvanized steel.

Blank ends are supplied as standard, knockouts are available upon request.

EZ Trim

Trims are made from code-gauge steel and painted ANSI 61 gray.

All panelboards have door-in-door as standard with multi-point catch and lock, and concealed mounting hardware.

Modifications

Table 22.3-10. Through-Feed Lugs, Sub-Feed Lugs (Main Lug Panels Only) and Sub-Feed Breakers (One Per Panel)

Ampere Rating	Information
All	Table 22.3-11

Shunt Trips

Shunt trips are available on two- and three-pole breakers.

Ground Bar

Standard bolted in box. Aluminum is standard, copper is available as an option.

Enclosures

Types 1, 12, 3R, 4/4X.

Surge Protective Device (SPD)

Integrated onto panelboard chassis. For complete product description and available ratings, refer to **Tab 34**.

Box Sizing and Selection

Box size for all Type 1 panelboards are available from **Table 22.3-4**.

Instructions

- Using description on the required panelboard, select the rating and type of mains required.
- Count total number of branch circuit poles (including spaces) required in the panelboard. Do not count main breaker poles. Convert two- or three-pole branch breakers to single-poles, i.e., three-pole breaker, count as three poles.

Note: For horizontal mounted mains (GHB Type), use main lug table, include space in branch section for mains.

- Using correct table, type of mains and ampere rating per Step 1, find total number of poles.

Note: Where total number of poles (Step 2) fall between number in table, use the next higher number.

- Read box size across columns to the right.

Top and Bottom Gutters (Minimum)

5.50 inches (139.7 mm).

Side Gutters

20.00-inch (508.0 mm) wide box:
5.50 inches (139.7 mm).

Table 22.3-11. Type 1 Panelboards—Dimensions in Inches (mm)

Panelboard Types	Types and Mounting Position (H) = Horizontal / (V) = Vertical		Maximum Number of Branch Circuits Including Provisions	Box Dimensions in Inches (mm) ①②③			Catalog Number				
	Main Breaker	Sub-Feed Breaker		Height	Width	Depth	YS Box	LT Trim	EZ Box	EZ Trim	
125 A											
Main lugs	—	—	12	36.00 (914.4)	20.00 (508.0)	5.75 (146.1)	YS2036	LT2036S or F	EZB2036R	EZT2036S or F	
			18	36.00 (914.4)	20.00 (508.0)	5.75 (146.1)	YS2036	LT2036S or F	EZB2036R	EZT2036S or F	
			24	42.00 (1219.2)	20.00 (508.0)	5.75 (146.1)	YS2042	LT2042S or F	EZB2042R	EZT2042S or F	
			30	42.00 (1219.2)	20.00 (508.0)	5.75 (146.1)	YS2042	LT2042S or F	EZB2042R	EZT2042S or F	
	—	—	36	48.00 (1219.2)	20.00 (508.0)	5.75 (146.1)	YS2048	LT2048S or F	EZB2048R	EZT2048S or F	
			42	48.00 (1219.2)	20.00 (508.0)	5.75 (146.1)	YS2048	LT2048S or F	EZB2048R	EZT2048S or F	
			48	72.00 (1828.8)	20.00 (508.0)	5.75 (146.1)	YS2072	LT2072S or F	EZB2072R	EZT2072S or F	
			—	—	—	—	—	—	—	—	—
	—	—	54	72.00 (1828.8)	20.00 (508.0)	5.75 (146.1)	YS2072	LT2072S or F	EZB2072R	EZT2072S or F	
			60	72.00 (1828.8)	20.00 (508.0)	5.75 (146.1)	YS2072	LT2072S or F	EZB2072R	EZT2072S or F	
			—	—	—	—	—	—	—	—	—
			—	—	—	—	—	—	—	—	—
Main breaker	EHD, FDB, FD, FDE, HFD, FDC, HFDE, FDCE (V)	—	12	36.00 (914.4)	20.00 (508.0)	5.75 (146.1)	YS2036	LT2036S or F	EZB2036R	EZT2036S or F	
			18	36.00 (914.4)	20.00 (508.0)	5.75 (146.1)	YS2036	LT2036S or F	EZB2036R	EZT2036S or F	
			24	42.00 (1219.2)	20.00 (508.0)	5.75 (146.1)	YS2042	LT2042S or F	EZB2042R	EZT2042S or F	
			30	42.00 (1219.2)	20.00 (508.0)	5.75 (146.1)	YS2042	LT2042S or F	EZB2042R	EZT2042S or F	
			36	48.00 (1219.2)	20.00 (508.0)	5.75 (146.1)	YS2048	LT2048S or F	EZB2048R	EZT2048S or F	
			42	48.00 (1219.2)	20.00 (508.0)	5.75 (146.1)	YS2048	LT2048S or F	EZB2048R	EZT2048S or F	
	—	—	48	72.00 (1828.8)	20.00 (508.0)	5.75 (146.1)	YS2072	LT2072S or F	EZB2072R	EZT2072S or F	
			—	—	—	—	—	—	—	—	—
			54	72.00 (1828.8)	20.00 (508.0)	5.75 (146.1)	YS2072	LT2072S or F	EZB2072R	EZT2072S or F	
			60	72.00 (1828.8)	20.00 (508.0)	5.75 (146.1)	YS2072	LT2072S or F	EZB2072R	EZT2072S or F	
			—	—	—	—	—	—	—	—	—
			—	—	—	—	—	—	—	—	—
Main lugs with 100 A through-feed lugs or sub-feed breaker	—	EHD, FDB, FD, FDE, HFD, FDC, HFDE, FDCE (V)	12	42.00 (1219.2)	20.00 (508.0)	5.75 (146.1)	YS2042	LT2042S or F	EZB2042R	EZT2042S or F	
			18	48.00 (1219.2)	20.00 (508.0)	5.75 (146.1)	YS2048	LT2048S or F	EZB2048R	EZT2048S or F	
			24	48.00 (1219.2)	20.00 (508.0)	5.75 (146.1)	YS2048	LT2048S or F	EZB2048R	EZT2048S or F	
			30	60.00 (1524.0)	20.00 (508.0)	5.75 (146.1)	YS2060	LT2060S or F	EZB2060R	EZT2060S or F	
			36	60.00 (1524.0)	20.00 (508.0)	5.75 (146.1)	YS2060	LT2060S or F	EZB2060R	EZT2060S or F	
			42	60.00 (1524.0)	20.00 (508.0)	5.75 (146.1)	YS2060	LT2060S or F	EZB2060R	EZT2060S or F	
	—	—	48	72.00 (1828.8)	20.00 (508.0)	5.75 (146.1)	YS2072	LT2072S or F	EZB2072R	EZT2072S or F	
			54	72.00 (1828.8)	20.00 (508.0)	5.75 (146.1)	YS2072	LT2072S or F	EZB2072R	EZT2072S or F	
			60	72.00 (1828.8)	20.00 (508.0)	5.75 (146.1)	YS2072	LT2072S or F	EZB2072R	EZT2072S or F	
			—	—	—	—	—	—	—	—	—
			—	—	—	—	—	—	—	—	—
			—	—	—	—	—	—	—	—	—
Main breaker with 100 A through-feed lugs or sub-feed breaker	EHD, FDB, FD, FDE, HFD, FDC, HFDE, FDCE (V)	EHD, FDB, FD, FDE, HFD, FDC, HFDE, FDCE (V)	12	42.00 (1219.2)	20.00 (508.0)	5.75 (146.1)	YS2042	LT2042S or F	EZB2042R	EZT2042S or F	
			18	48.00 (1219.2)	20.00 (508.0)	5.75 (146.1)	YS2048	LT2048S or F	EZB2048R	EZT2048S or F	
			24	48.00 (1219.2)	20.00 (508.0)	5.75 (146.1)	YS2048	LT2048S or F	EZB2048R	EZT2048S or F	
			30	60.00 (1524.0)	20.00 (508.0)	5.75 (146.1)	YS2060	LT2060S or F	EZB2060R	EZT2060S or F	
			36	60.00 (1524.0)	20.00 (508.0)	5.75 (146.1)	YS2060	LT2060S or F	EZB2060R	EZT2060S or F	
			42	60.00 (1524.0)	20.00 (508.0)	5.75 (146.1)	YS2060	LT2060S or F	EZB2060R	EZT2060S or F	
	—	—	48	72.00 (1828.8)	20.00 (508.0)	5.75 (146.1)	YS2072	LT2072S or F	EZB2072R	EZT2072S or F	
			54	72.00 (1828.8)	20.00 (508.0)	5.75 (146.1)	YS2072	LT2072S or F	EZB2072R	EZT2072S or F	
			60	72.00 (1828.8)	20.00 (508.0)	5.75 (146.1)	YS2072	LT2072S or F	EZB2072R	EZT2072S or F	
			—	—	—	—	—	—	—	—	—
			—	—	—	—	—	—	—	—	—
			—	—	—	—	—	—	—	—	—
225 A											
Main lugs or main breaker ④	EHD, FDB, FD, FDE, HFD, FDC, HFDE, FDCE (V)	—	12	36.00 (914.4)	20.00 (508.0)	5.75 (146.1)	YS2036	LT2036S or F	EZB2036R	EZT2036S or F	
			18	36.00 (914.4)	20.00 (508.0)	5.75 (146.1)	YS2036	LT2036S or F	EZB2036R	EZT2036S or F	
			24	42.00 (1219.2)	20.00 (508.0)	5.75 (146.1)	YS2042	LT2042S or F	EZB2042R	EZT2042S or F	
			30	42.00 (1219.2)	20.00 (508.0)	5.75 (146.1)	YS2042	LT2042S or F	EZB2042R	EZT2042S or F	
			36	48.00 (1219.2)	20.00 (508.0)	5.75 (146.1)	YS2048	LT2048S or F	EZB2048R	EZT2048S or F	
			42	48.00 (1219.2)	20.00 (508.0)	5.75 (146.1)	YS2048	LT2048S or F	EZB2048R	EZT2048S or F	
	—	—	48	72.00 (1828.8)	20.00 (508.0)	5.75 (146.1)	YS2072	LT2072S or F	EZB2072R	EZT2072S or F	
			54	72.00 (1828.8)	20.00 (508.0)	5.75 (146.1)	YS2072	LT2072S or F	EZB2072R	EZT2072S or F	
			—	—	—	—	—	—	—	—	—
			—	—	—	—	—	—	—	—	—
			—	—	—	—	—	—	—	—	—
			—	—	—	—	—	—	—	—	—
Main lugs or main breaker with 225 A through-feed lugs or sub-feed breaker ④	EHD, FDB, FD, FDE, HFD, FDC, HFDE, FDCE (V)	EHD, FDB, FD, FDE, HFD, FDC, HFDE, FDCE (V)	12	42.00 (1219.2)	20.00 (508.0)	5.75 (146.1)	YS2042	LT2042S or F	EZB2042R	EZT2042S or F	
			18	48.00 (1219.2)	20.00 (508.0)	5.75 (146.1)	YS2048	LT2048S or F	EZB2048R	EZT2048S or F	
			24	48.00 (1219.2)	20.00 (508.0)	5.75 (146.1)	YS2048	LT2048S or F	EZB2048R	EZT2048S or F	
			30	60.00 (1524.0)	20.00 (508.0)	5.75 (146.1)	YS2060	LT2060S or F	EZB2060R	EZT2060S or F	
			36	60.00 (1524.0)	20.00 (508.0)	5.75 (146.1)	YS2060	LT2060S or F	EZB2060R	EZT2060S or F	
			42	60.00 (1524.0)	20.00 (508.0)	5.75 (146.1)	YS2060	LT2060S or F	EZB2060R	EZT2060S or F	
	—	—	48	72.00 (1828.8)	20.00 (508.0)	5.75 (146.1)	YS2072	LT2072S or F	EZB2072R	EZT2072S or F	
			54	72.00 (1828.8)	20.00 (508.0)	5.75 (146.1)	YS2072	LT2072S or F	EZB2072R	EZT2072S or F	
			—	—	—	—	—	—	—	—	—
			—	—	—	—	—	—	—	—	—
			—	—	—	—	—	—	—	—	—
			—	—	—	—	—	—	—	—	—

① Smaller panelboard box sizes are available if required. Contact Eaton for application information.
 ② Add 8.00 inches (203.2 mm) for SPD and metering.
 ③ 28.00 inches (711.2 mm) optional width is available for panelboards with high circuit counts.
 ④ JD, HJD, JDC is same space requirement as 400 A DK, HKD, KDC.

Technical Data and Specifications—Pow-R-Line 3E

Table 22.3-11. Type 1 Panelboards—Dimensions in Inches (mm) (Continued)

Panelboard Types	Types and Mounting Position (H) = Horizontal / (V) = Vertical		Maximum Number of Branch Circuits Including Provisions	Box Dimensions in Inches (mm) ①②③			Catalog Number			
	Main Breaker	Sub-Feed Breaker		Height	Width	Depth	YS Box	LT Trim	EZ Box	EZ Trim
400 A										
Main lugs	—	—	12	48.00 (1219.2)	20.00 (508.0)	5.75 (146.1)	YS2048	LT2048S or F	EZB2048R	EZT2048S or F
	—	—	18	48.00 (1219.2)	20.00 (508.0)	5.75 (146.1)	YS2048	LT2048S or F	EZB2048R	EZT2048S or F
	—	—	24	60.00 (1524.0)	20.00 (508.0)	5.75 (146.1)	YS2060	LT2060S or F	EZB2060R	EZT2060S or F
	—	—	30	60.00 (1524.0)	20.00 (508.0)	5.75 (146.1)	YS2060	LT2060S or F	EZB2060R	EZT2060S or F
	—	—	36	60.00 (1524.0)	20.00 (508.0)	5.75 (146.1)	YS2060	LT2060S or F	EZB2060R	EZT2060S or F
	—	—	42	60.00 (1524.0)	20.00 (508.0)	5.75 (146.1)	YS2060	LT2060S or F	EZB2060R	EZT2060S or F
	—	—	48	72.00 (1828.8)	20.00 (508.0)	5.75 (146.1)	YS2072	LT2072S or F	EZB2072R	EZT2072S or F
	—	—	54	72.00 (1828.8)	20.00 (508.0)	5.75 (146.1)	YS2072	LT2072S or F	EZB2072R	EZT2072S or F
Main breaker	DK, KD, HKD, KDC, LHH (V)	—	12	60.00 (1524.0)	20.00 (508.0)	5.75 (146.1)	YS2060	LT2060S or F	EZB2060R	EZT2060S or F
		—	18	60.00 (1524.0)	20.00 (508.0)	5.75 (146.1)	YS2060	LT2060S or F	EZB2060R	EZT2060S or F
		—	24	60.00 (1524.0)	20.00 (508.0)	5.75 (146.1)	YS2060	LT2060S or F	EZB2060R	EZT2060S or F
		—	30	72.00 (1828.8)	20.00 (508.0)	5.75 (146.1)	YS2072	LT2072S or F	EZB2072R	EZT2072S or F
	—	36	72.00 (1828.8)	20.00 (508.0)	5.75 (146.1)	YS2072	LT2072S or F	EZB2072R	EZT2072S or F	
	—	42	72.00 (1828.8)	20.00 (508.0)	5.75 (146.1)	YS2072	LT2072S or F	EZB2072R	EZT2072S or F	
	—	48	72.00 (1828.8)	20.00 (508.0)	5.75 (146.1)	YS2072	LT2072S or F	EZB2072R	EZT2072S or F	
	—	54	90.00 (2286.0)	20.00 (508.0)	5.75 (146.1)	YS2090	LT2090S or F	EZB2090R	EZT2090S or F	
Main lugs with 225 or 100 A through-feed lugs or sub-feed breaker	—	EHD, FDB, FD, FDE, HFD, FDC, HFDE, FDCE (V)	12	60.00 (1524.0)	20.00 (508.0)	5.75 (146.1)	YS2060	LT2060S or F	EZB2060R	EZT2060S or F
			18	60.00 (1524.0)	20.00 (508.0)	5.75 (146.1)	YS2060	LT2060S or F	EZB2060R	EZT2060S or F
			24	72.00 (1828.8)	20.00 (508.0)	5.75 (146.1)	YS2072	LT2072S or F	EZB2072R	EZT2072S or F
			30	72.00 (1828.8)	20.00 (508.0)	5.75 (146.1)	YS2072	LT2072S or F	EZB2072R	EZT2072S or F
	36	72.00 (1828.8)	20.00 (508.0)	5.75 (146.1)	YS2072	LT2072S or F	EZB2072R	EZT2072S or F		
	42	72.00 (1828.8)	20.00 (508.0)	5.75 (146.1)	YS2072	LT2072S or F	EZB2072R	EZT2072S or F		
	48	90.00 (2286.0)	20.00 (508.0)	5.75 (146.1)	YS2090	LT2090S or F	EZB2090R	EZT2090S or F		
	54	90.00 (2286.0)	20.00 (508.0)	5.75 (146.1)	YS2090	LT2090S or F	EZB2090R	EZT2090S or F		
Main breaker with 225 or 100 A through-feed lugs or sub-feed breaker	DK, KD, HKD, KDC, LHH (V)	EHD, FDB, FD, FDE, HFD, FDC, HFDE, FDCE (V)	12	72.00 (1828.8)	20.00 (508.0)	5.75 (146.1)	YS2072	LT2072S or F	EZB2072R	EZT2072S or F
			18	72.00 (1828.8)	20.00 (508.0)	5.75 (146.1)	YS2072	LT2072S or F	EZB2072R	EZT2072S or F
			24	72.00 (1828.8)	20.00 (508.0)	5.75 (146.1)	YS2072	LT2072S or F	EZB2072R	EZT2072S or F
			30	72.00 (1828.8)	20.00 (508.0)	5.75 (146.1)	YS2072	LT2072S or F	EZB2072R	EZT2072S or F
	36	90.00 (2286.0)	20.00 (508.0)	5.75 (146.1)	YS2090	LT2090S or F	EZB2090R	EZT2090S or F		
	42	90.00 (2286.0)	20.00 (508.0)	5.75 (146.1)	YS2090	LT2090S or F	EZB2090R	EZT2090S or F		
	48	90.00 (2286.0)	20.00 (508.0)	5.75 (146.1)	YS2090	LT2090S or F	EZB2090R	EZT2090S or F		
	54	90.00 (2286.0)	20.00 (508.0)	5.75 (146.1)	YS2090	LT2090S or F	EZB2090R	EZT2090S or F		
Main Lugs with 400 A sub-feed breaker	—	DK, KD, HKD, KDC, LHH (V)	12	72.00 (1828.8)	20.00 (508.0)	5.75 (146.1)	YS2072	LT2072S or F	EZB2072R	EZT2072S or F
			18	72.00 (1828.8)	20.00 (508.0)	5.75 (146.1)	YS2072	LT2072S or F	EZB2072R	EZT2072S or F
			24	72.00 (1828.8)	20.00 (508.0)	5.75 (146.1)	YS2072	LT2072S or F	EZB2072R	EZT2072S or F
			30	72.00 (1828.8)	20.00 (508.0)	5.75 (146.1)	YS2072	LT2072S or F	EZB2072R	EZT2072S or F
	36	90.00 (2286.0)	20.00 (508.0)	5.75 (146.1)	YS2090	LT2090S or F	EZB2090R	EZT2090S or F		
	42	90.00 (2286.0)	20.00 (508.0)	5.75 (146.1)	YS2090	LT2090S or F	EZB2090R	EZT2090S or F		
	48	90.00 (2286.0)	20.00 (508.0)	5.75 (146.1)	YS2090	LT2090S or F	EZB2090R	EZT2090S or F		
	54	90.00 (2286.0)	20.00 (508.0)	5.75 (146.1)	YS2090	LT2090S or F	EZB2090R	EZT2090S or F		
Main breaker with 400 A sub-feed breaker	DK, KD, HKD, KDC, LHH (V)	DK, KD, HKD, KDC, LHH (V)	12	72.00 (1828.8)	20.00 (508.0)	5.75 (146.1)	YS2072	LT2072S or F	EZB2072R	EZT2072S or F
			18	72.00 (1828.8)	20.00 (508.0)	5.75 (146.1)	YS2072	LT2072S or F	EZB2072R	EZT2072S or F
			24	90.00 (2286.0)	20.00 (508.0)	5.75 (146.1)	YS2090	LT2090S or F	EZB2090R	EZT2090S or F
			30	90.00 (2286.0)	20.00 (508.0)	5.75 (146.1)	YS2090	LT2090S or F	EZB2090R	EZT2090S or F
	36	90.00 (2286.0)	20.00 (508.0)	5.75 (146.1)	YS2090	LT2090S or F	EZB2090R	EZT2090S or F		
	42	90.00 (2286.0)	20.00 (508.0)	5.75 (146.1)	YS2090	LT2090S or F	EZB2090R	EZT2090S or F		
	48	90.00 (2286.0)	20.00 (508.0)	5.75 (146.1)	YS2090	LT2090S or F	EZB2090R	EZT2090S or F		
	54	90.00 (2286.0)	20.00 (508.0)	5.75 (146.1)	YS2090	LT2090S or F	EZB2090R	EZT2090S or F		

① Smaller panelboard box sizes are available if required. Contact Eaton for application information.

② Add 8.00 inches (203.2 mm) for SPD and metering.

③ 28.00 inches (711.2 mm) optional width is available for panelboards with high circuit counts.

Table 22.3-12. Type 1 Panelboards—Dimensions in Inches (mm)

Panelboard Types	Types and Mounting Position (H) = Horizontal / (V) = Vertical		Maximum Number of Branch Circuits Including Provisions	Box Dimensions in Inches (mm) ①②③			Catalog Number				
	Main Breaker	Sub-Feed Breaker		Height	Width	Depth	YS Box	LT Trim	EZ Box	EZ Trim	
600 A											
Main lugs	—	—	12	48.00 (1219.2)	20.00 (508.0)	5.75 (146.1)	YS2048	LT2048S or F	EZB2048R	EZT2048S or F	
	—	—	18	48.00 (1219.2)	20.00 (508.0)	5.75 (146.1)	YS2048	LT2048S or F	EZB2048R	EZT2048S or F	
	—	—	24	60.00 (1524.0)	20.00 (508.0)	5.75 (146.1)	YS2060	LT2060S or F	EZB2060R	EZT2060S or F	
	—	—	30	60.00 (1524.0)	20.00 (508.0)	5.75 (146.1)	YS2060	LT2060S or F	EZB2060R	EZT2060S or F	
	—	—	36	60.00 (1524.0)	20.00 (508.0)	5.75 (146.1)	YS2060	LT2060S or F	EZB2060R	EZT2060S or F	
	—	—	42	60.00 (1524.0)	20.00 (508.0)	5.75 (146.1)	YS2060	LT2060S or F	EZB2060R	EZT2060S or F	
	—	—	48	72.00 (1828.8)	20.00 (508.0)	5.75 (146.1)	YS2072	LT2072S or F	EZB2072R	EZT2072S or F	
	—	—	54	72.00 (1828.8)	20.00 (508.0)	5.75 (146.1)	YS2072	LT2072S or F	EZB2072R	EZT2072S or F	
	Main breaker	LGE, LGH, LGC, LGU (V)	—	12	60.00 (1524.0)	20.00 (508.0)	5.75 (146.1)	YS2060	LT2060S or F	EZB2060R	EZT2060S or F
			—	18	60.00 (1524.0)	20.00 (508.0)	5.75 (146.1)	YS2060	LT2060S or F	EZB2060R	EZT2060S or F
—			24	60.00 (1524.0)	20.00 (508.0)	5.75 (146.1)	YS2060	LT2060S or F	EZB2060R	EZT2060S or F	
—			30	72.00 (1828.8)	20.00 (508.0)	5.75 (146.1)	YS2072	LT2072S or F	EZB2072R	EZT2072S or F	
—		—	36	72.00 (1828.8)	20.00 (508.0)	5.75 (146.1)	YS2072	LT2072S or F	EZB2072R	EZT2072S or F	
—		—	42	72.00 (1828.8)	20.00 (508.0)	5.75 (146.1)	YS2072	LT2072S or F	EZB2072R	EZT2072S or F	
—		—	48	72.00 (1828.8)	20.00 (508.0)	5.75 (146.1)	YS2072	LT2072S or F	EZB2072R	EZT2072S or F	
—		—	54	90.00 (2286.0)	20.00 (508.0)	5.75 (146.1)	YS2090	LT2090S or F	EZB2090R	EZT2090S or F	
Main lugs with 225 or 100 A through-feed lugs or sub-feed breaker		—	EHD, FDB, FD, FDE, HFD, FDC, HFDE, FDCE (V)	12	60.00 (1524.0)	20.00 (508.0)	5.75 (146.1)	YS2060	LT2060S or F	EZB2060R	EZT2060S or F
				18	60.00 (1524.0)	20.00 (508.0)	5.75 (146.1)	YS2060	LT2060S or F	EZB2060R	EZT2060S or F
	24			72.00 (1828.8)	20.00 (508.0)	5.75 (146.1)	YS2072	LT2072S or F	EZB2072R	EZT2072S or F	
	30			72.00 (1828.8)	20.00 (508.0)	5.75 (146.1)	YS2072	LT2072S or F	EZB2072R	EZT2072S or F	
	—	—	36	72.00 (1828.8)	20.00 (508.0)	5.75 (146.1)	YS2072	LT2072S or F	EZB2072R	EZT2072S or F	
	—	—	42	72.00 (1828.8)	20.00 (508.0)	5.75 (146.1)	YS2072	LT2072S or F	EZB2072R	EZT2072S or F	
	—	—	48	90.00 (2286.0)	20.00 (508.0)	5.75 (146.1)	YS2090	LT2090S or F	EZB2090R	EZT2090S or F	
	—	—	54	90.00 (2286.0)	20.00 (508.0)	5.75 (146.1)	YS2090	LT2090S or F	EZB2090R	EZT2090S or F	
	Main breaker with 225 or 100 A through-feed lugs or sub-feed breaker	EHD, FDB, FD, FDE, HFD, FDC, HFDE, FDCE (V)	EHD, FDB, FD, FDE, HFD, FDC, HFDE, FDCE (V)	12	72.00 (1828.8)	20.00 (508.0)	5.75 (146.1)	YS2072	LT2072S or F	EZB2072R	EZT2072S or F
				18	72.00 (1828.8)	20.00 (508.0)	5.75 (146.1)	YS2072	LT2072S or F	EZB2072R	EZT2072S or F
24				72.00 (1828.8)	20.00 (508.0)	5.75 (146.1)	YS2072	LT2072S or F	EZB2072R	EZT2072S or F	
30				72.00 (1828.8)	20.00 (508.0)	5.75 (146.1)	YS2072	LT2072S or F	EZB2072R	EZT2072S or F	
—		—	36	90.00 (2286.0)	20.00 (508.0)	5.75 (146.1)	YS2090	LT2090S or F	EZB2090R	EZT2090S or F	
—		—	42	90.00 (2286.0)	20.00 (508.0)	5.75 (146.1)	YS2090	LT2090S or F	EZB2090R	EZT2090S or F	
—		—	48	90.00 (2286.0)	20.00 (508.0)	5.75 (146.1)	YS2090	LT2090S or F	EZB2090R	EZT2090S or F	
—		—	54	90.00 (2286.0)	20.00 (508.0)	5.75 (146.1)	YS2090	LT2090S or F	EZB2090R	EZT2090S or F	
Main lugs with 400 A sub-feed breaker		—	DK, KD, HKD, KDC, LHH (V)	12	72.00 (1828.8)	20.00 (508.0)	5.75 (146.1)	YS2072	LT2072S or F	EZB2072R	EZT2072S or F
				18	72.00 (1828.8)	20.00 (508.0)	5.75 (146.1)	YS2072	LT2072S or F	EZB2072R	EZT2072S or F
	24			72.00 (1828.8)	20.00 (508.0)	5.75 (146.1)	YS2072	LT2072S or F	EZB2072R	EZT2072S or F	
	30			72.00 (1828.8)	20.00 (508.0)	5.75 (146.1)	YS2072	LT2072S or F	EZB2072R	EZT2072S or F	
	—	—	36	90.00 (2286.0)	20.00 (508.0)	5.75 (146.1)	YS2090	LT2090S or F	EZB2090R	EZT2090S or F	
	—	—	42	90.00 (2286.0)	20.00 (508.0)	5.75 (146.1)	YS2090	LT2090S or F	EZB2090R	EZT2090S or F	
	—	—	48	90.00 (2286.0)	20.00 (508.0)	5.75 (146.1)	YS2090	LT2090S or F	EZB2090R	EZT2090S or F	
	—	—	54	90.00 (2286.0)	20.00 (508.0)	5.75 (146.1)	YS2090	LT2090S or F	EZB2090R	EZT2090S or F	
	Main breaker with 400 A sub-feed breaker	DK, KD, HKD, KDC, LHH (V)	DK, KD, HKD, KDC, LHH (V)	12	72.00 (1828.8)	20.00 (508.0)	5.75 (146.1)	YS2072	LT2072S or F	EZB2072R	EZT2072S or F
				18	72.00 (1828.8)	20.00 (508.0)	5.75 (146.1)	YS2072	LT2072S or F	EZB2072R	EZT2072S or F
24				90.00 (2286.0)	20.00 (508.0)	5.75 (146.1)	YS2090	LT2090S or F	EZB2090R	EZT2090S or F	
30				90.00 (2286.0)	20.00 (508.0)	5.75 (146.1)	YS2090	LT2090S or F	EZB2090R	EZT2090S or F	
—		—	36	90.00 (2286.0)	20.00 (508.0)	5.75 (146.1)	YS2090	LT2090S or F	EZB2090R	EZT2090S or F	
—		—	42	90.00 (2286.0)	20.00 (508.0)	5.75 (146.1)	YS2090	LT2090S or F	EZB2090R	EZT2090S or F	
—		—	48	90.00 (2286.0)	20.00 (508.0)	5.75 (146.1)	YS2090	LT2090S or F	EZB2090R	EZT2090S or F	
—		—	54	90.00 (2286.0)	20.00 (508.0)	5.75 (146.1)	YS2090	LT2090S or F	EZB2090R	EZT2090S or F	

① Smaller panelboard box sizes are available if required. Contact Eaton for application information.
 ② Add 8.00 inches (203.2 mm) for SPD and metering.
 ③ 28.00 inches (711.2 mm) optional width is available for panelboards with high circuit counts.

This page intentionally left blank.

Pow-R-Line 4



PRL4B
Circuit Breaker
Panelboard

PRL4F
Fusible
Panelboard

General Description

Panelboard Ratings

Voltage

- 240 V, 480 V or 600 Vac maximum
- 600 Vdc maximum

Main Lugs

- 250–1200 A

Main Breakers

- 250–1200 A

Main Switches

- 200–1200 A

Branches

- Breakers 15–1200 A, bolt-on
- Breakers 20–600 A drawout
- Fusible switches 30–1200 A, bolt-on

Short-Circuit Current Ratings (Symmetrical)

- 240 Vac: 10–200 kA fully rated
- 240 Vac: 22–200 kA series rated
- 480 Vac: 14–200 kA fully rated
- 480 Vac: 22–150 kA series rated
- 250 Vdc: 10–22 kA fully rated

Service

- Three-phase, four-wire 208Y/120 V, 240/120 V delta and 480Y/277 V
- Single-phase, three-wire 120/240 V
- Single-phase, two-wire 120 V
- Three-phase, three-wire 120, 240, 480 and 600 V
- Two-wire 125 Vdc
- Two-wire 250 Vdc
- Two-wire 600 Vdc

Suitable for service entrance applications when specified.

Bussing

250–1200 A tin-plated aluminum is standard; copper is available as an option. Density rated bus is also available as an option.

Main Lugs Only

The short-circuit rating of the MLO assembled panelboard will be fully rated based upon the lowest rated branch device or may be series rated with an approved upstream device.

Main lugs only ampere ratings: 250, 400, 600, 800 and 1200.

Main Circuit Breakers

The short-circuit rating shown is that of the main breaker only. The short-circuit rating of the assembled panelboard is the rating of the lowest fully rated main or branch device, or the rating of an approved series rated combination.

Technical Data and Specifications—Pow-R-Line 4

Table 22.4-1. Main Circuit Breakers—Type PRL4B and PRL4D

Breaker Frame Amperes	Breaker Type	Interrupting Rating (kA Symmetrical)				
		240 Vac	480 Vac	600 Vac	250 Vdc	600 Vdc
250	JD	65	35	18	10	—
250	HJD	100	65	25	22	—
250	JDC	200	100	35	22	—
250	LCL	200	200	—	—	—
250 ①	HJDDC	—	—	—	42	35
350	NHH	100	65	35	—	—
400	DK	65	—	—	10	—
400	KD ②	65	35	25	10	—
400	CKD ②③	65	35	25	10	—
400	LHH	100	65	35	42	—
400	HKD ②	100	65	35	22	—
400	CHKD ②③	100	65	35	22	—
400	KDC ②	200	100	65	22	—
400	LCL ②	200	200	—	—	—
400	LA-P	200	200	200	②	—
400 ①	HKDDC	—	—	—	42	65
600	LGE ④	65	35	18	22	—
600	LGH ④	100	65	35	22	—
600	LGC ④	200	100	50	42	—
600	LGU	200	150	65	50	—
600	LD ②	65	35	25	22	—
600	CLD ②③	65	35	25	22	—
600	HLD ②	100	65	35	25	—
600	CHLD ②③	100	65	35	25	—
600	LDC ②	200	100	50	25	—
600	CLDC ③	200	100	50	25	—
600 ①	HLDDC	—	—	—	42	35
800	MDL ②	65	50	25	22	—
800	CMDL ②③	65	50	25	22	—
800	HMDL ②	100	65	35	25	—
800	CHMDL ②③	100	65	35	25	—
800	NB-P	200	200	200	⑤	—
800 ①	HMDLDC	—	—	—	42	35
800	NGS	85	50	25	—	—
800	CNGS	85	50	25	—	—
800	NGH	100	65	35	—	—
800	CNGH	100	65	35	—	—
800	NGC	200	100	65	—	—
800	CNGC	200	100	65	—	—
1200	NGS	85	50	25	—	—
1200	CNGS	85	50	25	—	—
1200	NGH	100	65	35	—	—
1200	CNGH	100	65	35	—	—
1200	NGC	200	100	65	—	—
1200	CNGC	200	100	65	—	—

- ① For use on DC systems only.
- ② Available with integral ground fault protection.
- ③ 100% rated circuit breaker.
- ④ Available in drawout configuration for PRL4D.
- ⑤ 100,000 AIC based on NEMA test procedure.

Main Fusible Switches

The short-circuit rating shown is that of the main switch only. The short-circuit rating of the assembled panelboards is the rating of the lowest fully rated main or branch device or the rating of an approved series rated combination. (Fuses are not included.)

400 and 600 A switches with shunt trip will be rated 100 kA.

Note: Circuit breaker panelboards are designated PRL4B. Fusible Switch panelboards are designated PRL4F.

Table 22.4-2. Main Fusible Switches

Switch Rating Amperes	Fuse Class	Interrupting Rating (kA Symmetrical)		
		240 Vac	600 Vac	250 Vdc
Switches Rated 240 Vac, 250 Vdc				
200	R, T	200	—	10
400	R, T	200	—	10
600	R, T	200	—	—
800	L	200	—	—
1200	L	200	—	—
Switches Rated 600 Vac				
200	R, J, T	200	200	—
400	R, J, T	200	200	—
600	R, J, T	200	200	—
800	L	200	200	—
1200	L	200	200	—

Table 22.4-3. Branch Circuit Breakers

Breaker Type	Ampere Rating	Number of Poles	Interrupting Rating (kA Symmetrical)							
			120 Vac	120/240 Vac	240 Vac	480 Vac	600 Vac	125 Vdc	250 Vdc	600 Vdc
BAB	15-70	1	10	—	—	—	—	—	—	—
BAB	15-100	2	—	10	—	—	—	—	—	—
BAB	15-100	2, 3	—	—	10	—	—	—	—	—
QBGF, QBGFEP	15-50 ①	1, 2	10	10	—	—	—	—	—	—
QBHW	15-70	1	22	—	—	—	—	—	—	—
QBHW	15-100	2	—	22	—	—	—	—	—	—
QBHW	15-100	2, 3	—	—	22	—	—	—	—	—
QBHGF, QBHGFEP	15-30	1, 2	22	22	—	—	—	—	—	—
GHB ②③	15-100	1	—	—	65	14	—	14	—	—
GHB ③	15-100	2, 3	—	—	65	14	—	—	14	—
GHQ ②③	15-20	1	—	—	65	14	—	—	—	—
HGHB ②③	15-30	1	—	—	65	25	—	—	—	—
GHBGFEP	15-60	1	—	—	65	—	—	—	—	—
EHD	15-100	1	—	—	14	14	—	10	—	—
EHD	15-100	2, 3	—	—	18	14	—	—	10	—
FDB	15-150	2, 3	—	—	18	14	14	—	10	—
FD ②	15-100	1	—	—	65	35	—	10	—	—
FD, FDE ④	15-225	2, 3	—	—	65	35	18	—	10	—
HFD ②	15-100	1	—	—	65	65	—	10	—	—
HFD, HFDE ④	15-225	2, 3	—	—	100	65	25	—	22	—
HFDDC ⑤	15-150	2,3	—	—	—	—	—	42	42	35
FDC, FDCE	15-225	2, 3	—	—	200	100	35	—	22	—
FB-P	15-100	2, 3	—	—	200	200	200	—	⑥	—
EDB	100-225	2, 3	—	—	22	—	—	10	—	—
EDS	100-225	2, 3	—	—	42	—	—	10	—	—
ED	100-225	2, 3	—	—	65	—	—	10	—	—
EDH	100-225	2, 3	—	—	100	—	—	10	—	—
EDC	100-225	2, 3	—	—	200	—	—	10	—	—
JD	70-250	2, 3	—	—	65	35	18	—	10	—
HJD	70-250	2, 3	—	—	100	65	25	—	22	—
JDC	70-250	2, 3	—	—	200	100	35	—	22	—
HJDDC ⑤	70-250	2, 3	—	—	—	—	—	42	42	35
LCL	125-250	2, 3	—	—	200	200	—	—	—	—
NHH	150-350	3	—	100	—	65	35	—	—	—
DK	250-400	2, 3	—	—	65	—	—	—	10	—
KD	100-400	2, 3	—	—	65	35	25	—	10	—
CKD ⑦	100-400	3	—	—	100	65	35	—	22	—
HKD	100-400	2, 3	—	—	100	65	35	—	22	—
LHH ⑥	125-400	2, 3	—	—	100	65	35	—	42	—
CHKD ⑦	100-400	3	—	—	100	65	35	—	22	—
KDC	100-400	2, 3	—	—	200	100	65	—	22	—
HKDDC ⑤	100-400	2, 3	—	—	—	—	—	42	42	35
LCL	200-400	2, 3	—	—	200	200	—	—	—	—
LA-P	125-400	2, 3	—	—	200	200	200	—	⑥	—
LGE	250-600	3	—	—	65	35	18	—	22	—
LGH	250-600	3	—	—	100	65	35	—	22	—
LGC	250-600	2, 3	—	—	200	100	50	—	42	—
LGU	250-600	2, 3	—	—	200	150	65	—	50	—
LD	300-600	2, 3	—	—	65	35	25	—	22	—
CLD ⑥	300-600	3	—	—	65	35	25	—	22	—
HLD	300-600	2, 3	—	—	100	65	35	—	25	—
CHLD ⑥	300-600	3	—	—	100	65	35	—	25	—
LDC	300-600	2, 3	—	—	200	100	50	—	25	—
CLDC ⑥	300-600	3	—	—	200	100	50	—	25	—
HLDDC ⑤	300-600	2, 3	—	—	—	—	—	42	42	35

① 50 A is two-pole only.
 ② Single-pole breaker rated 277 Vac.
 ③ At 480 V, use on 480Y/277 Vac system only.
 ④ Three-pole only.
 ⑤ For use on DC systems only.
 ⑥ 100,000 AIC based on NEMA test procedure.
 ⑦ 100% rated breaker. Requires copper bus. K- and N-Frame breakers require density rated copper bus. Not available in Type 12, 4 and 4X enclosures.

Table 22.4-3. Branch Circuit Breakers (Continued)

Breaker Type	Ampere Rating	Number of Poles	Interrupting Rating (kA Symmetrical)							
			120 Vac	120/240 Vac	240 Vac	480 Vac	600 Vac	125 Vdc	250 Vdc	600 Vdc
MDL	300–800	2, 3	—	—	65	50	25	—	22	—
CMDL ①	300–800	3	—	—	65	50	25	—	22	—
HMDL	300–800	2, 3	—	—	100	65	35	—	25	—
CHMDL	300–800	3	—	—	100	65	35	—	25	—
HMDLDC ②	300–800	2, 3	—	—	—	—	—	42	42	35
NGS	320–800	2, 3	—	—	85	50	25	—	—	—
CNGS ②	320–800	2, 3	—	—	85	50	25	—	—	—
NGH	320–800	2, 3	—	—	100	65	35	—	—	—
CNGH ②	320–800	2, 3	—	—	100	65	35	—	—	—
NGC	320–800	2, 3	—	—	200	100	65	—	—	—
CNGC ②	320–800	2, 3	—	—	200	100	65	—	—	—
NB-P	400–800	2, 3	—	—	200	200	200	—	—	—
NBDC ②	700–1200	2, 3	—	—	—	—	—	42	42	50
NGS	500–1200	2, 3	—	—	85	50	25	—	—	—
CNGS ②	500–1200	2, 3	—	—	85	50	25	—	—	—
NGH	500–1200	2, 3	—	—	100	65	35	—	—	—
CNGH ②	500–1200	2, 3	—	—	100	65	35	—	—	—
NGC	500–1200	2, 3	—	—	200	100	65	—	—	—
CNGC ②	500–1200	2, 3	—	—	200	100	65	—	—	—

① 100,000 AIC based on NEMA test procedure.

② For use on dc systems only.

Table 22.4-4. Branch Fusible Switches (Fuses are not included)

Switch Rating Amperes	Mounting	Fuse Class	Interrupting Rating (kA Symmetrical)		
			240 V	600 V	250 Vdc

Switches Rated 240 Vac, 250 Vdc

30/30	Twin	R	200	—	10
60/60	Twin	R	200	—	10
100/100	Twin	R	200	—	10
200/200	Twin	R, T	200	—	10
100	Single	R	200	—	10
200	Single	R, T	200	—	10
400	Single	R, T	200	—	10
600	Single	R, T	200	—	—
800	Single	L	200	—	—
1200	Single	L	200	—	—

Switches Rated 600 Vac

30/30	Twin	R, J	200	200	—
60/60	Twin	R, J	200	200	—
100/100	Twin	R, J	200	200	—
200/200	Twin	J, T	200	200	—
100	Single	R, J	200	200	—
200	Single	R, J, T	200	200	—
400	Single	R, J, T	200	200	—
600	Single	R, J, T	200	200	—
800	Single	L	200	200	—
1200	Single	L	200	200	—

Note: Twin branch switches of different ampere ratings are available, i.e., 30/60, 30/100, 60/100.

Circuit Breaker Trip Units

Circuit breakers will have thermal-magnetic trip units with the following exceptions:

- 100% rated breakers and all N-Frame breakers have Digitrip RMS 310 solid-state trip units as standard
- K-, L- and M-Frame three-pole circuit breakers are optionally available with the Digitrip RMS 310 solid-state trip unit
- The trip function options for the Digitrip RMS 310 include LS and LSI. Main circuit breakers can also include the LSG and LSG integral ground fault trip functions
- Digitrip OPTIM trip units are not available in panelboard construction

Series Rated Combinations

Refer to the series rating tables beginning on Page 22.0-14 for the approved series rated combinations available for the branch circuit breakers listed in Table 22.4-3.

Modifications

Enclosures

Types 12, 3R, 4/4X.

Ground Bar

Standard bolted in box with (3) #6–300 kcmil terminals. Aluminum is standard, copper is available as an option.

Trims

Trim with door is available as an option for Type 1 enclosures.

Surge Protective Device (SPD)

Integrated onto panelboard chassis. For complete product description and available ratings, refer to Tab 34.

Main Lug (MLO), Main Breaker, Neutral, Through-Feed (TFL) and Sub-Feed Lug (SFL) "X" Space Requirements

(For compression lugs, or other configurations not shown, refer to Eaton.)

● = Blank means no bus under cover to meet NEC cable bending space.

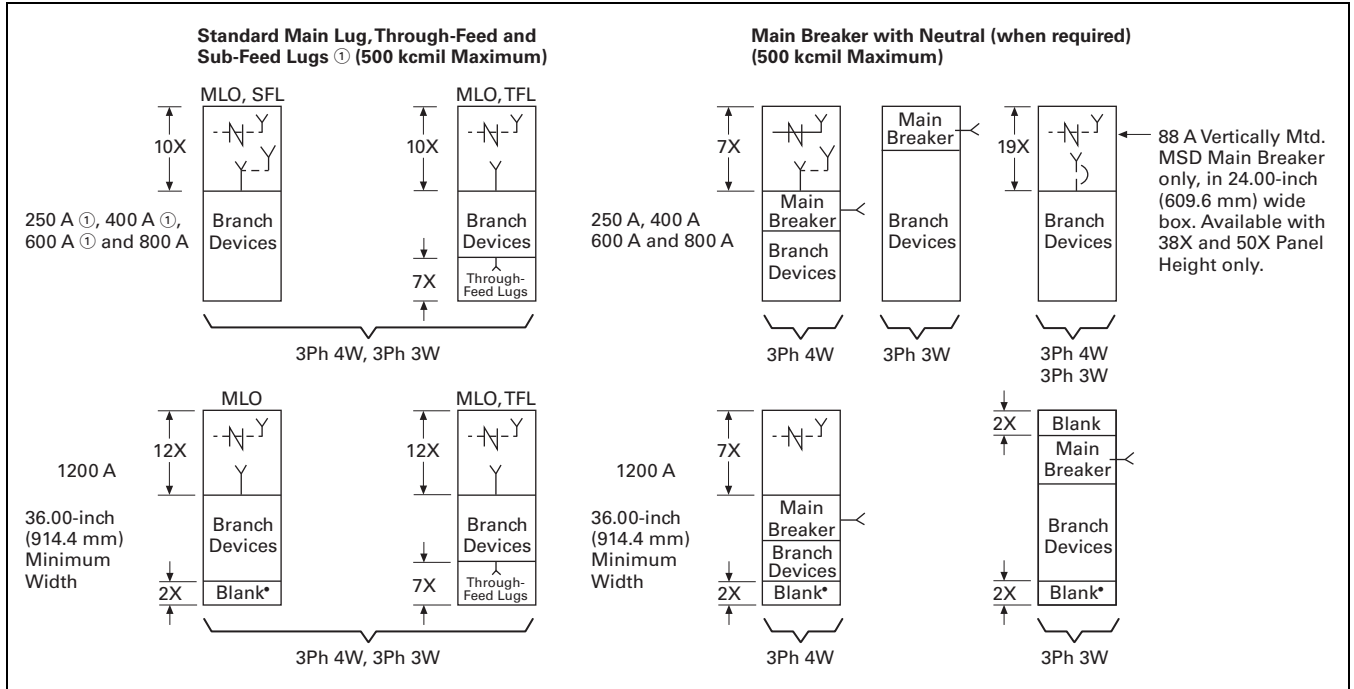

Figure 22.4-1. "X" Space Requirements—Dimensions in Inches (mm)

① Sub-feed lugs are available 250–600 A. For 600 A, use 1200 A "X" space.

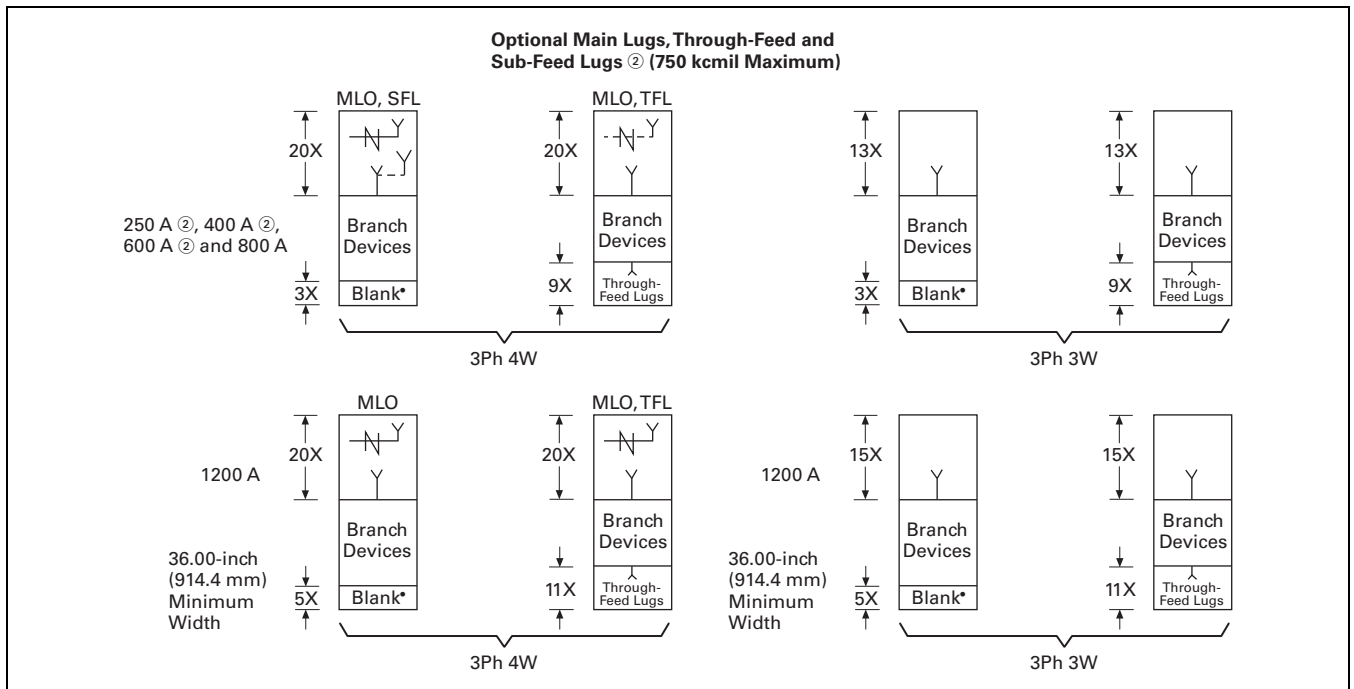

Figure 22.4-2. "X" Space Requirements—Dimensions in Inches (mm)

② Sub-feed lugs are available 250–600 A. For 600 A, use 1200 A "X" space.

Panelboard Layout and Dimensions—Pow-R-Line 4B

22

Breaker (PRL4B) Type Distribution
Panelboards 600 Vac, 250 Vdc

Panelboard Layout and Dimensions



To determine the dimensions of a given panelboard enclosure, make a layout sketch by fitting together the main branch and lug modules according to the appropriate tables in the layout guide. Assign "X" units to each module as shown and obtain a total "X" number.

The height of the enclosure is related to the total "X" units in the layout as shown in **Figure 22.4-3**. Three standard box heights are available to accommodate any and all layout arrangements. "X" unit totals that do not exactly match those in **Table 22.4-5** must be rounded off to the next higher standard (26X, 38X, 50X).

When a calculated "X" total for a panel exceeds 50X, the panel must be split into two or more separate sections with "X" space for through-feed lugs figured in for all but one section. If a neutral is required, a separate neutral bar and appropriate "X" space must be included in each section.

Layout Example

- 1 – PRL4B panelboard, 480Y/277V, three-phase, four-wire, 65 kA, 800A, main lug, consisting of:
 - 12 – 20 A/single-pole HFD
 - 2 – 250 A/three-pole HJD
 - 1 – 400 A/three-pole HKD

20 A/1P	20 A/1P	1X
20 A/1P	20 A/1P	1X
20 A/1P	20 A/1P	1X
20 A/1P	20 A/1P	1X
20 A/1P	20 A/1P	1X
20 A/1P	20 A/1P	1X
250 A/3P		3X
250 A/3P		3X
400 A/3P		4X
Main Lugs	800 A 	10X
Neutral		
TOTAL =		26X

1. From layout guide, total "X" height of panel = 26X, (which is a design standard and no rounding off is necessary).
2. From **Table 22.4-5**, enclosure height for 26X panel = 57.00 inches (1447.8 mm).
3. Width = 24.00 inches (609.6 mm)—directly from layout guide.
4. Total enclosure depth = 11.30 inches (287.0 mm)—standard for all PRL4 panelboards.

Note: For SPD unit, add 7X up to 200 kA and 10X for SPD above 200 kA.

Table 22.4-5. Standard Panelboard and Box—Dimensions in Inches (mm)

Panel Height	Box Height	Box Width	Box ^① Depth
26X	57.00 (1447.8)	24.00 (609.6) ^②	10.40 (264.2)
38X	73.50 (1866.9)	24.00 (609.6) ^②	10.40 (264.2)
50X	90.00 (2286.0)	24.00 (609.6) ^②	10.40 (264.2)
38X	73.50 (1866.9)	36.00 (914.4)	10.40 (264.2)
50X	90.00 (2286.0)	36.00 (914.4)	10.40 (264.2)
38X	73.50 (1866.9)	44.00 (1117.6)	10.40 (264.2)
50X	90.00 (2286.0)	44.00 (1117.6)	10.40 (264.2)

① Box depth is 10.40 inches (264.2 mm), cover adds 0.90 inches (22.9 mm) for overall enclosure depth of 11.30 inches (287.0 mm).

② 800 A maximum bus size in 24.00 inches (609.6 mm) wide box.

Note: Flush trims available on PRL4B panels with Door-in-Door enclosure only.

Top and Bottom Gutters (Minimum)

- 10.62 inches (269.9 mm)

Side Gutters (Minimum)

- 24.00-inch (609.6 mm) wide box: 5.00 inches (127.0 mm)
- 36.00-inch (914.4 mm) wide box: 6.00 inches (152.4 mm)
- 44.00-inch (1117.6 mm) wide box: 8.00 inches (203.2 mm)

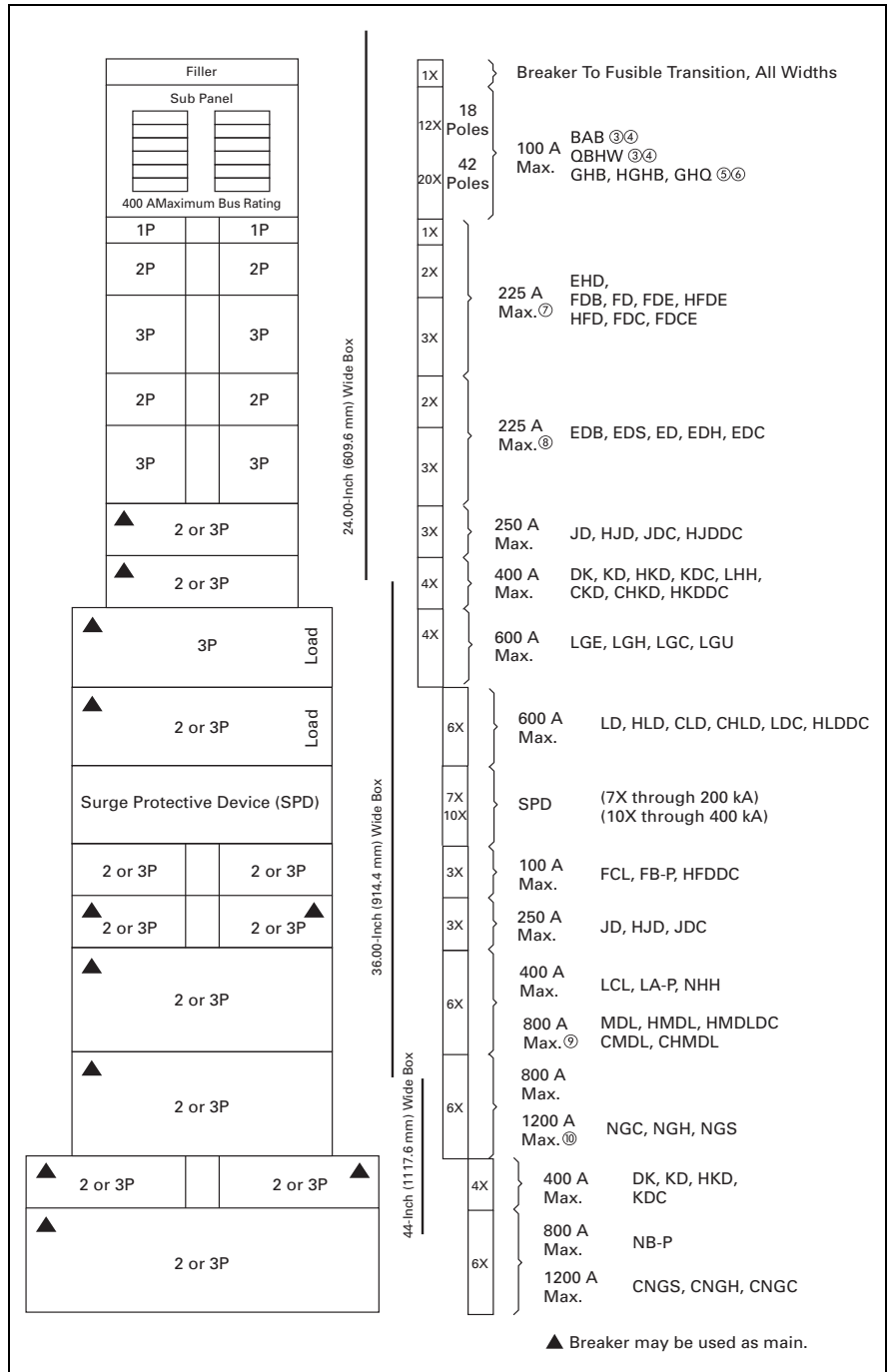

Figure 22.4-3. Layout for Branch and Horizontally Mounted Main Devices

- ③ BAB and QBHW breakers with shunt trips require one additional pole space, i.e., single-pole is two-pole size, two-pole is three-pole size, and three-pole is four-pole size.
- ④ If panel contains only BAB or QBHW branch breakers, use a PRL1a panelboard.
- ⑤ GHB, HGHB or GHQ breakers cannot be mixed on same subchassis as BAB, QBHW.
- ⑥ If panel contains only GHB, HGHB or GHQ branch breakers, use a PRL2a panelboard.
- ⑦ When only one single-pole breaker of the group is required on either side of chassis, the single-pole breaker space required changes from 1X to 2X.
- ⑧ Minimum 36.00-inch (914.4 mm) wide box is required if optional #6–300 kcmil lug is required.
- ⑨ MDL main breaker in 24.00-inch (609.6 mm) wide box, refer to **Figure 22.4-1**.
- ⑩ Optional 750 kcmil terminal requires 44.00-inch (1117.6 mm) wide box.

Note: See **Page 22.4-5** for MLO or Neutral and Vertically Mounted Mains space requirements.

Main Lug (MLO), Main Switch, Neutral Through-Feed Lug (TFL) and Sub-Feed Lug (SFL) "X" Space Requirements

(For other configurations refer to Eaton.)

● = Blank means no bus under cover to meet NEC cable bending space.

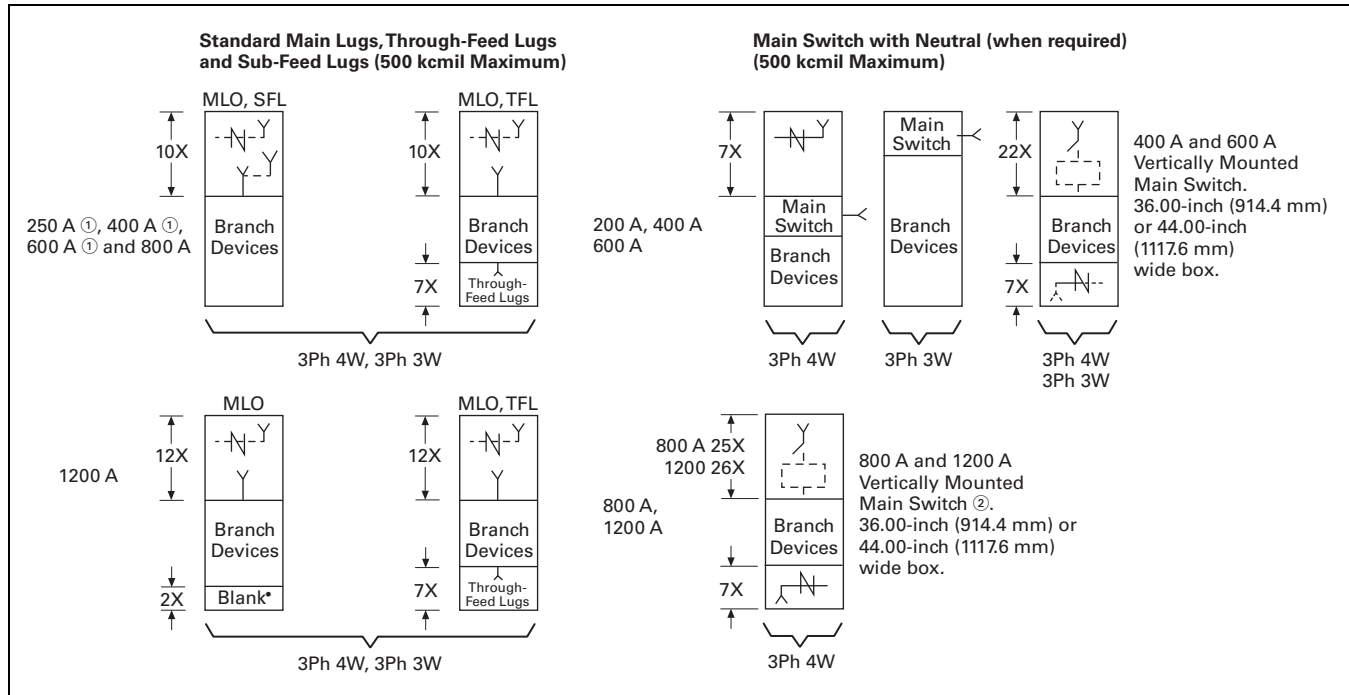

Figure 22.4-4. "X" Space Requirements—Dimensions in Inches (mm)

- ① Sub-feed lugs are available 250–600 A. For 600 A, use 1200 A "X" space.
- ② 800 and 1200 A mains available only in vertical mounting.

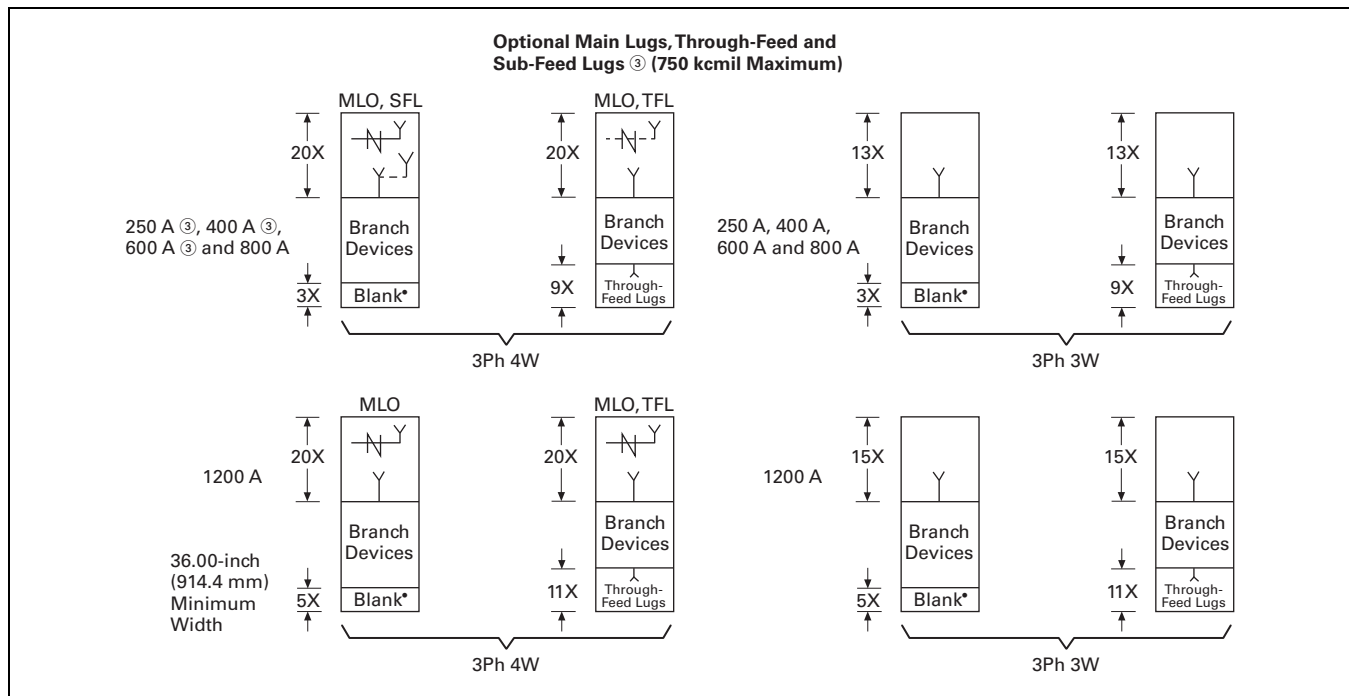

Figure 22.4-5. "X" Space Requirements—Dimensions in Inches (mm)

- ③ Sub-feed lugs are available 250–600 A. For 600 A, use 1200 A "X" space.

**Fusible (PRL4F) Type Distribution
Panelboards 600 Vac, 250 Vdc**

Panel Layout and Dimensions

To determine the dimensions of a given panelboard enclosure, make a layout sketch by fitting together the main branch and lug modules according to the appropriate tables in the layout guide. Assign "X" units to each module as shown and obtain a total "X" number.

The height of the enclosure is related to the total "X" units in the layout as shown in **Figure 22.4-6**. Three standard box heights are available to accommodate any and all layout arrangements. "X" unit totals that do not exactly match those in **Table 22.4-6** must be rounded off to the next higher standard (38X, 50X).

When a calculated "X" total for a panel exceeds 50X, the panel must be split into two or more separate sections with "X" space for through-feed lugs figured in for all but one section. If a neutral is required, a separate neutral bar and appropriate "X" space must be included in each section.

Layout Example

1 – PRL4F, three-phase, four-wire, 208Y/120 V complete with 400 A main switch and the following branches:

- 1 – 200 A/three-pole
- 2 – 100 A/three-pole
- 2 – 30 A/three-pole

Panel to have short-circuit rating of 100,000A symmetrical.

400 A Neutral		7X
30 A/three-pole	30A/three-pole	4X
100 A/three-pole	100A/three-pole	4X
200 A/three-pole		6X
400A three-pole main switch (vertically mounted)		22X
Total =		43X

1. From layout guide, "X" height of panel = 43X.
2. Rounded off to next higher standard = 50X.
3. From **Table 22.4-6**, enclosure height for 50X panel = 90.00 inches (2286.0 mm).
4. Width = 36.00 inches (914.4 mm) because no switch in the assembly requires a 44.00-inch (1117.6 mm) wide enclosure.
5. Total enclosure depth = 11.30 inches (287.0 mm) — standard for all PRL4 panelboards.

Cabinet Specifications

Boxes: Code-gauge commercial galvanized sheet steel (no knockouts).

Note: In the above example, if a horizontally mounted 400 A main switch was used, the enclosure size would be: 73.50 inches H x 44.00 inches W x 11.30 inches D (1866.9 mm H x 1117.6 mm W x 287.0 mm D).

Panelboard Layout and Dimensions—Pow-R-Line 4F

Table 22.4-6. Standard Panel and Box — Dimensions in Inches (mm)

Panel Height	Box Height	Box Width	Box ① Depth
38X	73.50 (1866.9)	36.00 (914.4)	10.40 (264.2)
50X	90.00 (2286.0)	36.00 (914.4)	10.40 (264.2)
38X	73.50 (1866.9)	44 (1117.6)	10.40 (264.2)
50X	90.00 (2286.0)	44.00 (1117.6)	10.40 (264.2)

① Box depth is 10.40 inches (264.2 mm), cover adds 0.90 inches (22.9 mm) for overall enclosure depth of 11.30 inches (287.0 mm).

Note: Flush trims are available on PRL4F panels with door-in-door enclosure only.

Top and Bottom Gutters (minimum)

- 10.63 inches (269.9 mm)

Side Gutters (minimum)

- 36.00-inch (914.4) wide box:
 - 200 A maximum— 8.00 inches (203.2 mm)
 - 400–1200 A maximum— 6.00 inches (152.4 mm)
- 44.00-inch (1117.6 mm) wide box:
 - 200 A maximum— 10.00 inches (254.0 mm)
 - 400–1200 A maximum— 8.00 inches (203.2 mm)

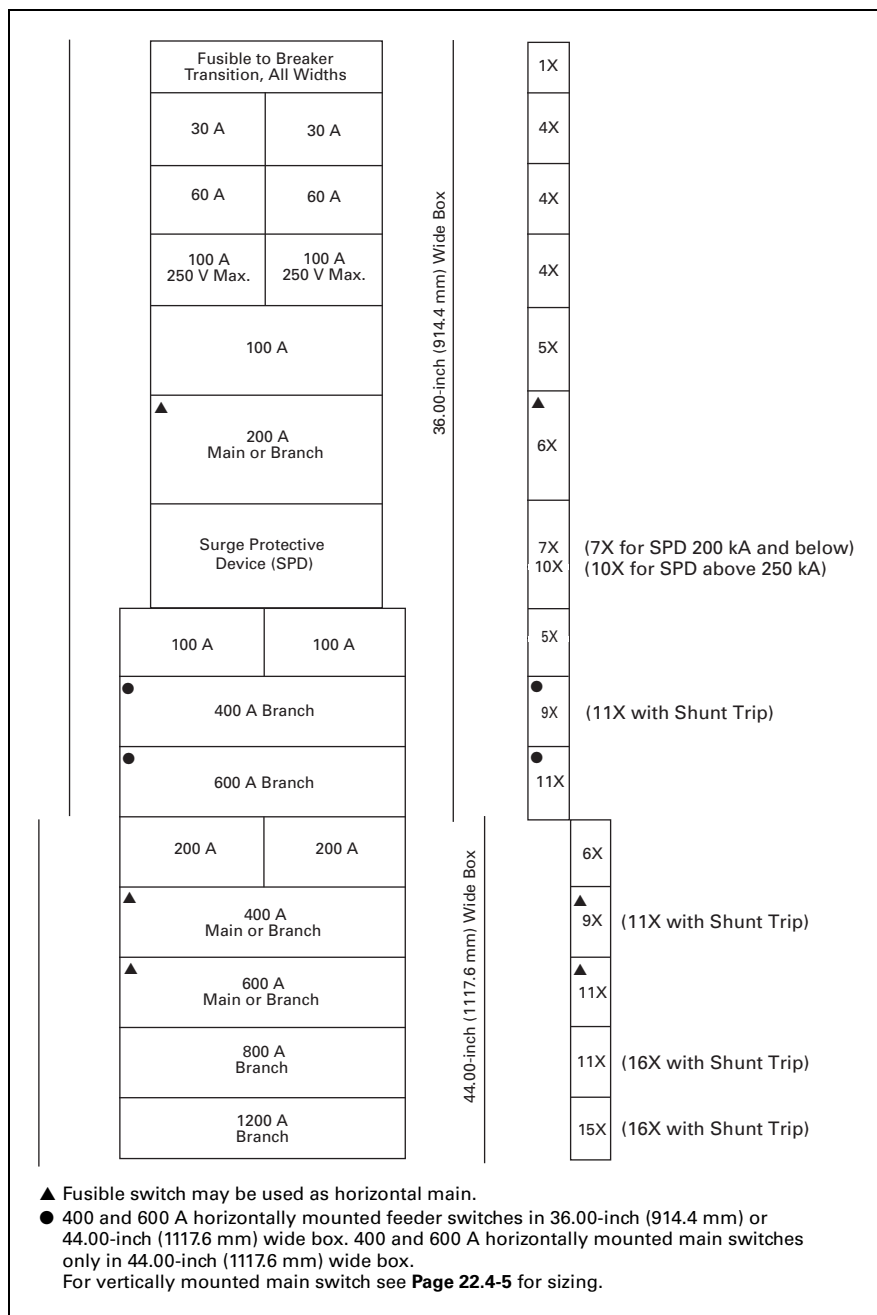

▲ Fusible switch may be used as horizontal main.
 ● 400 and 600 A horizontally mounted feeder switches in 36.00-inch (914.4 mm) or 44.00-inch (1117.6 mm) wide box. 400 and 600 A horizontally mounted main switches only in 44.00-inch (1117.6 mm) wide box.
 For vertically mounted main switch see Page 22.4-5 for sizing.

Figure 22.4-6. Branch and Horizontally Mounted Main Fusible Switch Layout — Dimensions in Inches (mm)

Note: See Page 22.4-8 for MLO or neutral and vertically mounted main space requirements.

Pow-R-Line 4D



*Type PRL4D Drawout Molded-Case
Circuit Breaker Power Panelboard*

General Description

- Drawout molded-case circuit breaker power panelboard
- Front accessible
- Front connected
- Through-the-door design drawout mechanism
- Visual indication of breaker status and position
- Large grab handles for easy removal
- 600 Vac maximum
- 1200 A maximum mains
- 600 A maximum drawout molded-case feeder breakers

Application Description

- Interrupting ratings up to 200 kAIC symmetrical
- Feeder power panelboard
- Rated as Service Entrance Equipment when appropriately equipped
- Ideal for:
 - Data centers
 - Industrial facilities
 - Process equipment manufacturing
 - Anywhere that requires quick change of feeder devices is needed

Benefits

- Ease of maintenance
- Faster to remove and install
- Less downtime

Standards and Certifications

- UL 67 Listed chassis
- UL 50 Listed box and trim

Technical Data

Instructions

Determine box size by locating all main and feeder devices in your panel. The width of box is determined by the maximum box size shown for each device. For main lugs, through-feed lugs and sub-feed lugs.

Panelboard Layout and Dimensions—Pow-R-Line 4D

Table 22.4-7. Standard Panel and Box — Dimensions in Inches (mm)

Panel Height	Box Height	Box Width	Box ① Depth
38X	73.50 (1866.9)	36.00 (914.4)	11.31 (287.0)
50X	90.00 (2286.0)	36.00 (914.4)	11.31 (287.0)
38X	73.50 (1866.9)	44.00 (1117.6)	11.31 (287.0)
50X	90.00 (2286.0)	44.00 (1117.6)	11.31 (287.0)

① Box depth is 10.40 inches (264.2 mm); cover adds 0.90 inches (22.9 mm), for overall enclosure depth of 11.30 inches (287.0 mm).

Note: Flush trims not available on PRL4D panels. Door-to-door option not available on PRL4D panels.

Top and Bottom Gutters (minimum)

- 10.63 inches (269.9 mm)

Side Gutters (minimum)

- 36.00-inch (914.4) wide box:
 - 6.00 inches (152.4 mm)
- 44.00-inch (1117.6 mm) wide box:
 - 8.00 inches (203.2 mm)

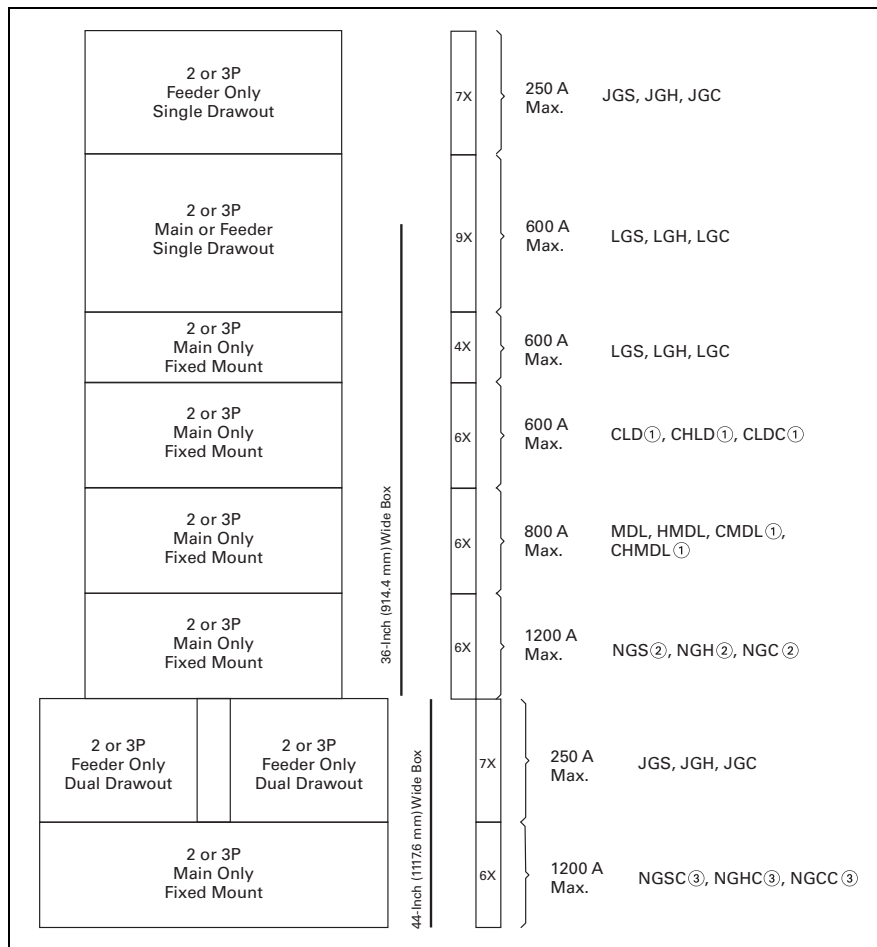

Figure 22.4-7. Layout for Branch and Horizontally Mounted Main Devices—PRL4D

- ① 100% rated breaker.
- ② Optional 750 kcmil terminal requires 44.00-inch (1117.6 mm) wide box.
- ③ Contact Eaton for availability.

**Power Xpert
Multipoint Meter**



*Power Xpert Multipoint Meter
Switchboards and Panelboards*

When you need accurate information of consumed energy for monthly invoicing statements, use Eaton's integrated multipoint metering solution. Using Power Xpert Multipoint Metering for utility allocation maximizes revenue by effectively measuring, allocating and recovering utility expenditures. The Power Xpert Multipoint Metering solution can interface with a third-party utility allocation service. The Power Xpert Multipoint Metering solution offers to:

- Purchase energy at bulk rates while charging consumer rates
- Capitalize on naturally variable tenant loads by purchasing energy at lower coinciding load
- Capture and allocate common area maintenance cost
- Promote tenant retention with accurate and defensible billing
- Eliminate subsidization of other tenants

Benefits

- Factory-wired system
- Integrated display
- Saves floor space
- Lower installed cost
- Network compatible
- Tenant sub-billing
- UL Listed
- Integral Web-based and third-party software solutions available

General Description

Allocation of energy consumption in a residential or commercial application is a tremendous task for a property owner, management firm or electrical energy manager. To assist in allocation or direct billing of consumed energy, use Eaton's Power Xpert Multipoint Meter low cost solutions. The Power Xpert Multipoint Meter provides a cost-effective energy tabulation system for residential or commercial metering installations. These installations can include:

- High-rise buildings
- Universities and campuses
- Office buildings
- Apartment and condominium complexes
- Shopping malls
- Airports
- System commissioning is required and priced separately



Factory Assembled and Wired Meters

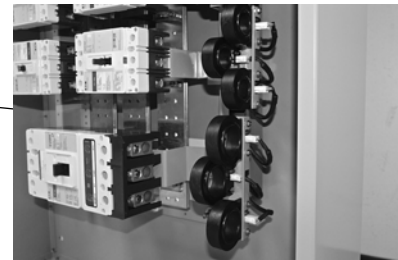

Power Xpert Multipoint Meter—CTs are Factory-Mounted and Wired to Meter

The Power Xpert Multipoint Metering Panelboard Uses the Pow-R-Line 4 Panelboard with Eaton's Power Xpert™ Multipoint Meter and Current Sensors

Local display and network capable devices are available as optional components.

See **Tab 3, Section 3.1** Metering for more information.

Layout Guide

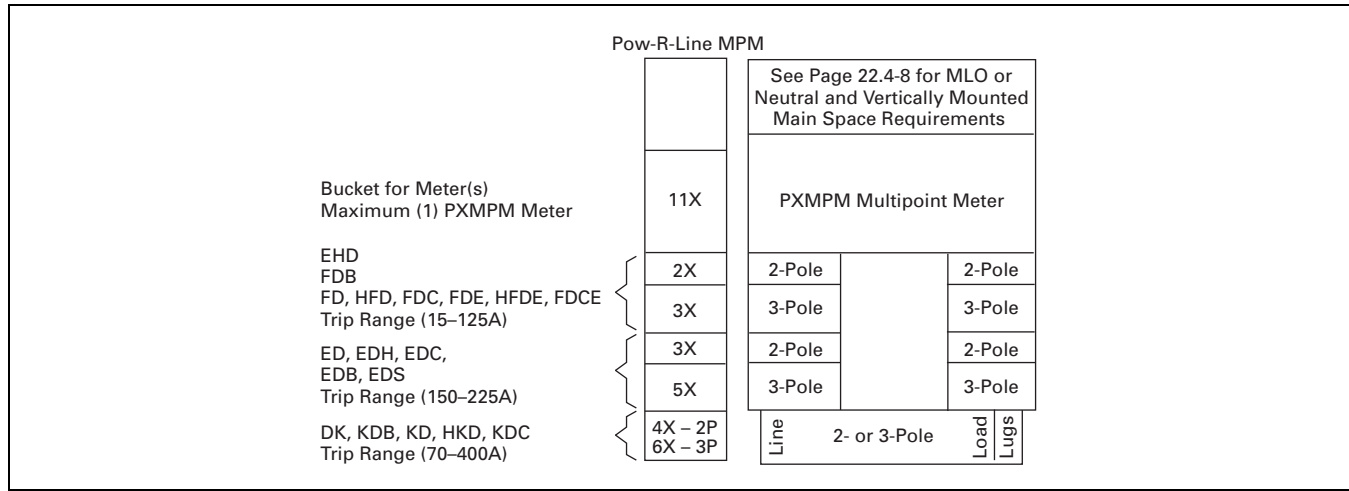

Figure 22.4-8. Power Xpert MPM Layout Guide for Current Sensor and Current Transformer Sizing—Standard Pow-R-Line 4 Panelboard Construction Applies

Note: For all other breaker frames and amperages, consult factory for “X” space sizing.

Note: Consult Section 22.4 for Pow-R-Line 4 structure configuration.

Table 22.4-8. Power Xpert MPM Breaker Frames

Breaker Type	Maximum Trip Amperes	Number of Poles	Current Sensor (100 mA) I.D. in Inches	“X” Space	Minimum Enclosure Width in Inches (mm)
EHD	100	2	0.53	2X	36.00 (914.4)
EHD	100	3		3X	
FDB, FD, HFD, FDC	125	2	0.53	2X	36.00 (914.4)
FDB, FD, HFD, FDC, FDE, HFDE, FDCE	125	3		3X	
EDB, EDS, ED, EDH, EDC, FD, HFD, FDC	225	2	1.12	3X	36.00 (914.4)
EDB, EDS, ED, EDH, EDC, FD, HFD, FDC, FDE, HFDE, FDCE	225	3		5X	
DK, KD, HKD, KDC (Single Mounting Only)	400	2	1.74	4X	36.00 (914.4)
DK, KD, HKD, KDC (Single Mounting Only)	400	3		6X	

Pow-R-Line PXBCM Panelboard

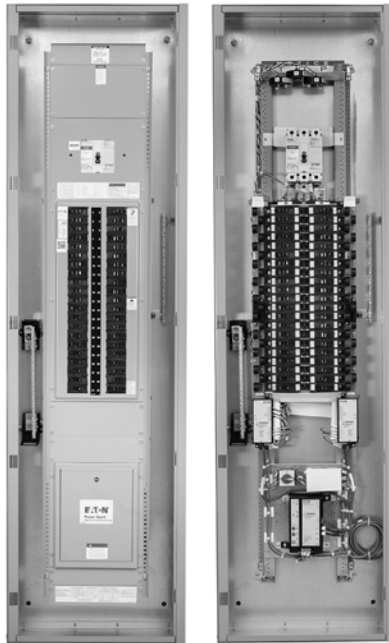

Pow-R-Line PXBCM Panelboard

General Description

Eaton's Pow-R-Line Branch Circuit Monitoring (PXBCM) panelboards is an integrated, affordable metering device that combines exceptional performance and easy installation to deliver a cost-effective solution for branch circuit level energy and power monitoring. The Pow-R-Line PXBCM can monitor up to 84 branch circuits and 16 main and auxiliary panel connections.

The Pow-R-Line PXBCM panelboard provides a means to monitor main power coming into the panelboard and up to four additional three-phase meters. The Pow-R-Line PXBCM panelboard can be used in lighting appliance, small power distribution panelboards, and Pow-R-Command lighting control panelboards with a maximum 400 A main breaker and 125 A branch breakers.

The Pow-R-Line PXBCM panelboard is available in PRL1a, PRL2a, and PRL3e panelboard classifications.

Application Description

The Pow-R-Line PXBCM can be used in various industries and LEED certified buildings. There is a rapidly changing emphasis on LEED designs and the Pow-R-Line PXBCM panelboard helps you meet the measurement and verification points required by LEED and the U.S. Green Building Council. Some applications the Pow-R-Line PXBCM panelboard include:

- Energy management
- Industrial monitoring
- Cost allocation
- Data center management
- Light commercial
- Industrial
- Institutions

Features and Benefits

The Pow-R-Line PXBCM panelboard offers Modbus® RS-485 and TCP output standard while allowing flexibility for onboard configuration. Also, communication and analysis can be communicated through an integrated Web server or a number of building automation sources, including Eaton's Power Xpert and Foreseer® products.

The Pow-R-Line PXBCM panelboard allows you to:

- Make informed load shifting and load shedding decisions
- Fairly and accurately allocate energy costs to users
- Identify wasteful practices
- Decrease unnecessary usage
- Produce an energy profile

Pow-R-Line PXBCM key features include:

- Power and energy readings at the branch circuit level
- Integrated Web server for remote monitoring and configuration
- Optional remote color touchscreen display for local readings
- Compatibility with the Power Xpert gateway for remote monitoring

Product Specifications

NEMA Enclosure Options and Dimensions in Inches (mm)

A variety of NEMA enclosures are available as options: NEMA Type 1, 2, 3R, 4, 4X, and 12. Pow-R-Line 1a, 2a, with 400 A main bus, all PRL3e and Pow-R-Command panel applications require a 28-inch wide box to provide additional gutter space for cable bending.

Heights

- 36.00 (914.4)
- 42.00 (1066.8)
- 48.00 (1219.2)
- 60.00 (1524.0)
- 72.00 (1828.8)
- 90.00 (2286.0)

Widths ①

- 20.00 (508.0)
- 28.00 (711.2)

Depth ①

- 5.75 (146.1)

① Dimensions for NEMA Type 1 enclosure. For dimensions of optional NEMA enclosure, contact your Eaton distributor or sales engineer.

Pow-R-Line PXBCM Panelboard

Technical Data and Specifications

Table 22.4-9. Pow-R-Line 1a, 2a and 3e Specifications

Description	Rating
Pow-R-Line 1a Ratings	
Voltage	240 Vac maximum
Main breaker	100–600 A
Main lug	100–600 A
Maximum kAIC	10–22 kA fully rated
	22–200 kA series rated
Branch circuit breaker	15–100 A
Branch breaker connector	140 A
Branch circuit breaker types	BA (BAB, BAB-H), QBH (QBHW, QBHW-H), QBGFT, QBGFEP, QBH-GFT, QBHGFEP, HQP, QPHW, QHPX, QPGF, QPHGF, QPGEP, QPHGFEP, BABR, QBAF, QBAG, QBHAF, QBCAF and QBHCAF
Pow-R-Line 2a Ratings	
Voltage	240 Vac, 480Y/277 Vac and 125/250 Vdc maximum
Main breaker	100–600 A
Main lug	100–600 A
Maximum kAIC	240 Vac: 65 kA fully rated 65–200 kA series rated
	480Y/277 Vac: 14 kA fully rated 22–150 kA series rated
	125/250 Vdc: 10–14 kA fully rated
Branch circuit breaker	15–100 A
Branch breaker connector	140 A
Branch circuit breaker types	GB, GHB, GHBGFEP, HGHB, GO, GHQ, GHQRD ① and GHQRSP ①
Pow-R-Line 3e Ratings	
Voltage	240 Vac, 480Y/277 Vac or 480 Vac and 250 Vdc maximum
Main breaker	125–400 A ②
Main lug	100–400 A ②
Maximum kAIC	240 Vac: 20–100 kA fully rated 100–200 kA series rated
	480Y/277 Vac or 480 Vac: 18–65 kA fully rated 65–100 kA series rated
	250 Vdc: 10–42 kA fully rated
Branch circuit breaker	15–125 A
Branch breaker connector	140 A
Branch circuit breaker types	EGB, EGS and EGH

① Remote operated circuit breaker.

② 600A is available without main metering.

Table 22.4-10. Meter Measurement Parameters

Measured Parameter	Main	Branch	Virtual ③
Current per phase	■	—	—
Maximum and minimum current per phase	■	—	—
Current demand per phase	■	—	—
Peak current demand per phase	■	—	—
Forward and reverse energy (kWh) per phase	■	—	—
Maximum and minimum real power (W) per phase	■	—	—
Apparent power (VA)	■	—	■
Power factor total ④	■	—	—
Power factor per phase	■	—	—
Maximum and minimum voltage (line-to-line)	■	—	—
Maximum and minimum voltage (line-to-neutral)	■	—	—
Maximum and minimum voltage (phase A)	■	—	—
Current	—	■	—
Maximum current	—	■	■
Current demand	—	■	—
Real power (W)	—	■	—
Forward and reverse real power (W) demand	—	■	■
Forward and reverse energy (kWh) per circuit	—	■	—
Maximum apparent power (kVA)	—	■	—
Power factor	—	■	■
Virtual meters	—	—	■
Average current	—	—	■
Forward and reverse energy (kWh)	—	—	■
Forward and reverse power (W) demand	—	—	■
Forward and reverse power (W) peak demand	—	—	■
Maximum real power (W)	—	—	■
Maximum apparent power (VA)	—	—	■

③ Virtual means Web server.

④ Based on a three-phase breaker rotation.

Modifications and Accessories

Because each Pow-R-Line 1a, 2a, and 3e panelboard is assembled by an experienced technician, we can easily and efficiently incorporate any combination of modifications and accessories, including:

- Breaker lock-off devices
- Compression type lugs (main lugs only)
- Arc fault breakers
- Increased dimensions
- Trim to fix existing boxes
- Main breakers with solid-state trip units
- Permanent circuit numbering
- Service entrance
- Special doors and locks
- Surge protection devices
- Pow-R-Command lighting control

Note: Contact your local Eaton distributor or sales engineer for additional information on these and other modifications and accessories.

This page intentionally left blank.

Pow-R-Line 1a-LX



Pow-R-Line 1a-LX Column Type

General Description

Panelboard Ratings

Voltage

- 240 Vac maximum

Main Lugs

- 100 and 225 A

Main Breakers

- 100 and 225 A

Branch Breakers

- 15–100 A (bolt-on)

Short-Circuit Current Ratings (Symmetrical)

- 240 Vac: 10 kA and 22 kA fully rated
- 240 Vac: 22–200 kA series rated

Service

- Three-phase, four-wire 208Y/120 V and 240/120 V delta
- Single-phase, three-wire 120/240 V
- Single-phase, two-wire 120 V
- Three-phase, three-wire 208 and 240 V

Mains

For available mains, refer to **Table 22.5-1**.

Main breakers, 100 A, Types BAB and QBHW are horizontally mounted, same as branch breakers. All other main breakers are vertically mounted.

Branch Circuits

For available branch devices, refer to **Table 22.5-2**.

Main Lugs Only

The short-circuit rating of the MLO assembled panelboard will be fully rated based upon the lowest rated branch device or may be series rated with an approved upstream device.

Main lugs only ampere ratings: 100 and 225.

Main Circuit Breakers

The short-circuit rating shown is that of the main breaker only. The short-circuit rating of the assembled panelboard is the rating of the lowest fully rated main or branch device or the rating of an approved series rated combination.

Table 22.5-1. Main Circuit Breakers

Breaker Frame Amperes	Breaker Type	Interrupting Rating (kA Symmetrical) at 240 Vac	
		100 A	225 A
100	BAB	10	22
	QBHW	22	22
	EHD	18	22
150	FDB	18	65
	FD, FDE	65	100
	HFD, HFDE	100	200
	FDC	200	200
225	EDB	22	42
	EDS	42	65
	ED, FD	65	100
	EDH, HFD	100	200
	EDC, FDC	200	200

Table 22.5-2. Branch Circuit Breakers

Breaker Type	Ampere Rating	Number of Poles	Interrupting Rating (kA Symmetrical)		
			120 Vac	120/240 Vac	240 Vac
BAB	15–70	1	10	—	—
BAB	15–100	2	—	10	—
BAB	15–100	2, 3	—	—	10
BAB-D ①	15–60	1, 2	10	10	—
BAB-C ②	15–30	1, 2	10	10	—
BABRP ③	15–30	1, 2	10	10	—
BABRSP ③	15–30	1, 2	10	10	—
QBGF	15–50 ④	1, 2	10	10	—
QBGFEP	15–50 ④	1, 2	10	10	—
QBCAF ⑤	15–20	1	10	10	—
QBHW	15–70	1	22	—	—
QBHW	15–100	2	—	22	—
QBHW	15–100	2, 3	—	—	22
QBHGF	15–30 ④	1, 2	22	22	—
QBGFEP	15–30 ④	1, 2	22	22	—
QBHCAF ⑤	15–20	1	22	22	—

① HID (High Intensity Discharge) rated breaker.

② Switching neutral breaker. Single-pole device requires two-pole space, two-pole device requires three-pole space.

③ Solenoid operated breaker.

④ 50 A is two-pole only.

⑤ Arc fault breaker.

Series Rated Combinations

Refer to series rating tables beginning on **Page 22.0-14** for the approved series rated combinations available for the branch circuit breakers listed in **Table 22.5-2**.

Technical Data and Specifications

Bussing

100–225 A: copper is standard.

Boxes

Boxes are made from code-gauge steel.

Blank ends are supplied as standard.

Trims

Trims are made from code-gauge steel and painted ANSI 61 gray.

Doors have three-point catch and lock.

Neutral Bars

When column type panels are furnished with trough extensions and pull box, the neutral bar will be placed in the pull box unless otherwise specified.

When troughs and pull box are not furnished, the neutral bar will be located on the panel at the same end as the main.

Cabinets

Boxes and trims are code-gauge steel. ANSI-61 light gray painted finish.

Boxes are furnished without knockouts.

Standard depth is 6.00 inches (152.4 mm). Standard width is 8.63 inches (219.1 mm).

Top and Bottom Gutters

4.50 inches (114.3 mm) minimum.

Left Side Gutter

4.50 inches (114.3 mm) minimum.

Pull Box

Pull box is furnished without knockouts.

Modifications

Table 22.5-3. Sub-Feed Breakers (One Per Panel)

Ampere Rating Space	Breaker Type	Interrupting Rating (kA Symmetrical) at 240 V
150	FDB	18
150	FD, FDE	65
150	HFD, HFDE	100
150	FDC	200
225	EDB	22
225	EDS	42
225	ED, FD, FDE	65
225	EDH, HFD, HFDE	100
225	EDC, FDC	200

Shunt Trips

Shunt trips are available on BAB, QBHW and FDB breakers. BAB and QBHW require one additional pole space for shunt trip, i.e., single-pole is two-pole size, two-pole is three-pole size and three-pole is four-pole size.

Ground Bar

Standard bolted in box. Aluminum is standard, copper is available as an option.

Assembled Circuit Breaker Panelboards

Box size, box and trim catalog numbers for standard column type panelboards listed are available from **Table 22.5-4**.

Instructions

1. Using description of the required panelboard, select the rating and type of main required.
 - a. 100 A panelboards—**Table 22.5-4**.
 - b. 225 A panelboards—**Table 22.5-4**.
2. Count total number of branch circuit poles, including provisions, required in the panelboard. Do not count main breaker poles. Convert two- or three-pole branch breakers to single poles, i.e., three-pole breaker, count as three poles.

Determine sub-feed breaker or through-feed lug requirements.
3. Select the panelboard main ampere rating from **Table 22.5-4**.
4. Panelboard Type from first column, main breaker Frame and Designation, if applicable from second column, and sub-feed breaker Frame and Designation, if applicable, from the third column.
5. From Step 2, determine the number of branch circuits in Column 4.
6. Read box size numbers across columns to the right. All panels are surface mounted.

Table 22.5-4. Panelboards—Dimensions in Inches (mm)

Panelboard Types	Main Breaker Types Mounting: (H) = Horizontal (V) = Vertical	Sub-Feed Breaker Types Vertical Mounting	Maximum Number of Branch Circuits Including Provisions	Box Dimensions ①		
				Height	Width	Depth
100 A						
Main breaker	BAB, QBHW (H)	—	27 39	69.00 (1752.6) 81.00 (2057.4)	8.63 (219.1) 8.63 (219.1)	6.00 (152.4) 6.00 (152.4)
Main lugs or main breaker	EHD, FDB, FD, FDE, HFD (V), HFDE	—	30 42	69.00 (1752.6) 81.00 (2057.4)	8.63 (219.1) 8.63 (219.1)	6.00 (152.4) 6.00 (152.4)
Main lugs or main breaker with 100 A through-feed lugs or sub-feed breaker		EDB, EDS, ED, EDH, EHD, FD, FDE, HFD, HFDE	30 42	78.00 (1981.2) 90.00 (2286.0)	8.63 (219.1) 8.63 (219.1)	6.00 (152.4) 6.00 (152.4)
225 A						
Main lugs or main breaker	EHD, FDB, FD, FDE, HFD, HFDE, ED, EDH (V)	—	30 42	69.00 (1752.6) 81.00 (2057.4)	8.63 (219.1) 8.63 (219.1)	6.00 (152.4) 6.00 (152.4)
Main lugs or main breaker with 225 A through-feed lugs or sub-feed breaker		EDB, EDS, ED, EDH, EHD, FD, FDE, HFD, HFDE	30 42	78.00 (1981.2) 90.00 (2286.0)	8.63 (219.1) 8.63 (219.1)	6.00 (152.4) 6.00 (152.4)

① For horizontal mounted mains (BAB Type), use main lug table, include space in branch section for mains.

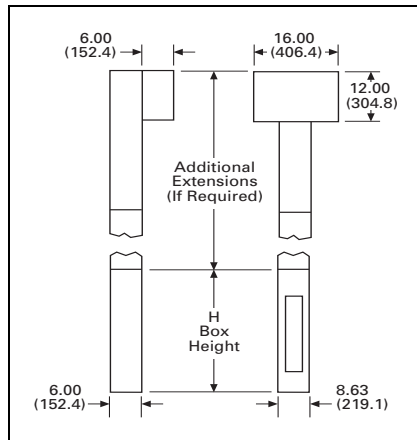

Figure 22.5-1. Trough Extension — Dimensions in Inches (mm)

Trough Extension

When extension troughs are used, the NEC requires that the number of conductors in wireways shall not contain more than 30 conductors at any cross section, unless the conductors are for signal circuits or are control conductors between a motor and its starter and used only for starting duty. The sum of the cross-sectional areas of all contained conductors at any cross section of a wireway shall not exceed 20% of the interior cross-sectional area of the wireway.

The derating factors specified in the NEC shall not be applicable to the 30 current-carrying conductors at 20% fill specified above.

Pow-R-Line 2a-LX



Pow-R-Line 2a-LX Column Type

General Description

Panelboard Ratings

Voltage

- 240 Vac
- 480Y/277 Vac maximum

Note: PRL2a panelboards are suitable for use on three-phase, three-wire applications when derived from a three-phase, four-wire 480Y/277 Vac service where the neutral is not brought to the panelboard. For three-phase, three-wire 480 Vac delta services, use a PRL3a panelboard.

- 250 Vdc maximum

Main Lugs

- 100 and 225 A

Main Breakers

- 100 and 225 A

Branch Breakers

- 15–100 A

Short-Circuit Current Ratings (Symmetrical)

- 240 Vac: 65 kA fully rated
- 240 Vac: 100–200 kA series rated
- 480Y/277 Vac: 14 kA fully rated
- 480Y/277 Vac: 22–150 kA series rated
- 250 Vdc: 10 kA and 14 kA fully rated

Service

- Three-phase, four-wire 208Y/120 V and 240/120 V delta and 480Y/277 V
- Single-phase, three-wire 120/240 V
- Single-phase, two-wire 120 V
- Three-phase, three-wire 208 and 240 V
- Two-wire 125 Vdc
- Two-wire 250 Vdc

Mains

For available mains, refer to **Table 22.5-5**.

Type GHB main breakers are horizontally mounted, same as branch breakers. All other main breakers are vertically mounted.

Branch Circuits

For available branch devices, refer to **Table 22.5-6**.

Main Lugs Only

The short-circuit rating of the MLO assembled panelboard will be fully rated based upon the lowest rated branch device or may be series rated with an approved upstream device.

Main lugs only ampere ratings: 100 and 225.

Main Circuit Breakers

The short-circuit rating shown is that of the main breaker only. The short-circuit rating of the assembled panelboard is the rating of the lowest fully rated main or branch device or the rating of an approved series rated combination.

Table 22.5-5. Main Circuit Breakers

Breaker Frame Amperes	Breaker Type	Interrupting Rating (kA Symmetrical)		
		240 Vac	480Y/277 Vac	125/250 Vdc
100	GHB	65	14	14
100	EHD	18	14	10
150	FDB	18	14	10
150	FD, FDE	65	35	10
150	HFD, HFDE	100	65	22
150	FDC, FDCE	200	100	22
225	ED	65	—	—
225	FD, FDE	65	35	10
225	EDH	100	—	—
225	HFD, HFDE	100	65	10
225	EDC	200	—	—
225	FDC	200	100	10

Table 22.5-6. Branch Circuit Breakers

Breaker Type	Ampere Rating	Number of Poles	Interrupting Rating (kA Symmetrical)				
			120 Vac	240 Vac	277 Vac	480Y/277 Vac	125/250 Vdc
GHB	15–100	1	65	—	14	—	14
GHB	15–100	2, 3	—	65	—	14	14
GHQ	15–20	1	65	—	14	—	—
HGHB	15–30	1	65	—	25	—	—
GHQRSP ①	15–20	1, 2	65	65	14	14	—
GHBS ①	15–30	1, 2	65	65	14	14	—

① Solenoid operated breaker.

Series Rated Combinations

Refer to series rating tables beginning on **Page 22.0-14** for the approved series rated combinations available for the branch circuit breakers listed in **Table 22.5-6**.

Technical Data and Specifications

Bussing

100–225 A: copper is standard.

Boxes

Boxes are made from code-gauge steel. Blank ends are supplied as standard.

Trims

Trims are made from code-gauge steel and painted ANSI 61 gray.

Doors have three-point catch and lock.

Neutral Bars

When column type panels are furnished with trough extensions and pull box, the neutral bar will be placed in the pull box unless otherwise specified.

When troughs and pull box are not furnished, the neutral bar will be located on the panel at the same end as the main.

Cabinets

Boxes and trims are code-gauge steel. ANSI-61 light gray painted finish.

Boxes are furnished without knockouts.

Standard depth is 6.00 inches (152.4 mm). Standard width is 8.63 inches (219.1 mm).

Top and Bottom Gutters

4.50 inches (114.3 mm) minimum.

Left Side Gutter

3.31 inches (84.2 mm) minimum.

Pull Box

Pull box is furnished without knockouts.

Modifications

Table 22.5-7. Sub-Feed Breakers (One Per Panel)

Ampere Rating Space	Breaker Type	Interrupting Rating (kA Symmetrical)	
		240 V	480 V
150	FDB	18	14
150	FD, FDE	65	35
150	HFD, HFDE	100	65
150	FDC	200	100
225	ED	65	—
225	FD, FDE	65	35
225	EDH	100	—
225	HFD, HFDE	100	65
225	EDC	200	—
225	FDC	200	100

Shunt Trips

Shunt trips are available on GHB, FDB and FD breakers. GHB breakers with shunt trips require three-pole frame.

Ground Bar

Standard bolted in box. Aluminum is standard, copper is available as an option.

Assembled Circuit Breaker Panelboards

Box size, box and trim catalog numbers for standard column type panelboards listed are available from **Table 22.5-8**.

Instructions

- Using description of the required panelboard, select the rating and type of main required.
 - 100 A panelboards—**Table 22.5-8**.
 - 225 A panelboards—**Table 22.5-8**.
- Count total number of branch circuit poles, including provisions, required in the panelboard. Do not count main breaker poles. Convert two- or three-pole branch breakers to single poles, i.e., three-pole breaker, count as three poles. Determine sub-feed breaker or through-feed lug requirements.
- Select the panelboard main ampere rating from **Table 22.5-8**.
- Panelboard type from first column, main breaker frame and designation, if applicable from second column, and sub-feed breaker frame and designation, if applicable, from the third column.
- From Step 2, determine the number of branch circuits in Column 4.
- Read box size numbers across columns to the right. All panels are surface mounted.

Technical Data and Specifications—Pow-R-Line 2a-LX Column Type

Table 22.5-8. Panelboards—Dimensions in Inches (mm)

Panelboard Types	Main Breaker Types Mounting: (H) = Horizontal (V) = Vertical	Sub-Feed Breaker Types Vertical Mounting	Maximum Number of Branch Circuits Including Provisions	Box Dimensions ①		
				Height	Width	Depth
100 A						
Main breaker	GHB (H)	— —	27	69.00 (1752.6)	8.63 (219.1)	6.00 (152.4)
			39	81.00 (2057.4)	8.63 (219.1)	6.00 (152.4)
Main lugs or main breaker	EHD, FDB, FD, FDE HFD, HFDE, FDCE (V)	— —	30	69.00 (1752.6)	8.63 (219.1)	6.00 (152.4)
			42	81.00 (2057.4)	8.63 (219.1)	6.00 (152.4)
Main lugs or main breaker with 100 A through-feed lugs or sub-feed breaker		FD, FDE, HFD, HFDE, FDC, FDCE	30	78.00 (1981.2)	8.63 (219.1)	6.00 (152.4)
			42	90.00 (2286.0)	8.63 (219.1)	6.00 (152.4)
225 A						
Main lugs or main breaker	EHD, FDB, FD, FDE, HFD, HFDE (V)	— —	30	69.00 (1752.6)	8.63 (219.1)	6.00 (152.4)
			42	81.00 (2057.4)	8.63 (219.1)	6.00 (152.4)
Main lugs or main breaker with 225 A through-feed lugs or sub-feed breaker		FD, FDE FDE, HFD, HFDE, FDC	30	78.00 (1981.2)	8.63 (219.1)	6.00 (152.4)
			42	90.00 (2286.0)	8.63 (219.1)	6.00 (152.4)

① For horizontal mounted mains (BAB Type), use main lug table, include space in branch section for mains.

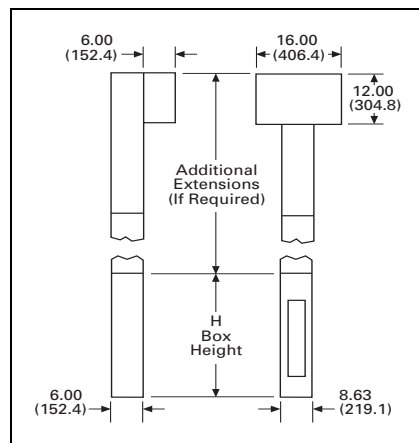

Figure 22.5-2. Trough Extension—Dimensions in Inches (mm)

Trough Extension

When extension troughs are used, the NEC requires that the number of conductors in wireways shall not contain more than 30 conductors at any cross section, unless the conductors are for signal circuits or are control conductors between a motor and its starter and used only for starting duty. The sum of the cross-sectional areas of all contained conductors at any cross section of a wireway shall not exceed 20% of the interior cross-sectional area of the wireway.

The derating factors specified in the NEC shall not be applicable to the 30 current-carrying conductors at 20% fill specified above.

Pow-R-Line 1R Retrofit Panelboard



Pow-R-Line 1R

General Description

Panelboard Ratings

Voltage

- 240 Vac maximum

Main Lugs

- 100–400 A

Main Breakers

- 100–225 A

Branch Breakers

- 15–100 A (bolt-on chassis)

Short-Circuit Current Ratings (Symmetrical)

- 240 Vac: 10 kA and 22 kA fully rated
- 240 Vac: 22–200 kA series rated

Service

- Three-phase, four-wire 208Y/120 V and 240/120 V delta
- Single-phase, three-wire 120/240 V
- Single-phase, two-wire 120 V
- Three-phase, three-wire 208 and 240 V

Suitable for service entrance applications when specified.

Mains

For available mains, refer to **Table 22.6-1**.

Main breakers, 100 A, Types BAB and QBH are horizontally mounted, same as branch breakers. All other main breakers are vertically mounted.

Branch Circuits

For available branch devices, refer to **Table 22.6-2**.

Eaton offers a factory-assembled panelboard interior and trim designed to bolt directly into an existing enclosure.

Custom-built panelboard interiors and trims can be provided to retrofit most any manufacturer's existing panelboard enclosure.

The panelboards are listed and are marked with both the Underwriters Laboratories (UL) and Canadian Standards Association (CSA®) labels.

Why Retrofit?

- Upgrade protective device interrupting ratings
- Replacing old, obsolete circuit breakers with new
- Providing additional circuits for load growth
- Accommodating system change and additions
- Adding ground fault circuit interrupters

Immediate Benefits

- Installation time is dramatically reduced
- Disruption of existing power service is minimal
- Less cleanup and wall repair because there is no need to cut and break concrete or finished wall surface

Main Lugs Only

The short-circuit rating of the MLO assembled panelboard will be fully rated based upon the lowest rated branch device, or may be series rated with an approved upstream device.

Main lugs only ampere ratings: 100 and 225.

Main Circuit Breakers

The short-circuit rating shown is that of the main breaker only. The short-circuit rating of the assembled panelboard is the rating of the lowest fully rated main or branch device, or the rating of an approved series rated combination.

Table 22.6-1. Main Circuit Breakers

Breaker Frame Amperes	Breaker Type	Interrupting Rating (kA Symmetrical) at 240 V
100	BAB	10
100	QBHW	22
100	EHD	18
150	FDB	18
225	FD, FDE	65
225	HFD, HFDE	100
225	FDC	200
225	EDB	22
225	EDS	42
225	ED	65
225	EDH	100
225	EDC	200

Table 22.6-2. Branch Circuit Breakers

Breaker Type	Ampere Rating	Number of Poles	Interrupting Rating (kA Symmetrical)		
			120 V	120/240 V	240 V
BAB	15–70	1	10	—	—
BAB	15–100	2	—	10	—
BAB	15–100	2, 3	—	—	10
BAB-D ①	15–60	1, 2	10	10	—
BAB-C ②	15–30	1, 2	10	10	—
BABRP ③	15–30	1, 2	10	10	—
BABRSP ③	15–30	1, 2	10	10	—
QBGF, QBGFEP	15–50 ④	1, 2	10	10	—
QBCAF ⑤	15–20	1	10	10	—
QBHW	15–70	1	22	—	—
QBHW	15–100	2	—	22	—
QBHW	15–100	2, 3	—	—	22
QBHGF, QBGFEP	15–30	1, 2	22	22	—
QBHCAF ⑤	15–20	1	22	22	—

① HID (High Intensity Discharge) rated breaker.

② Switching neutral breaker. Single-pole device requires two-pole space, two-pole device requires three-pole space.

③ Solenoid operated breaker.

④ 50 A is two-pole only.

⑤ Arc fault breaker.

Series Rated Combinations

Refer to series rating tables beginning on **Page 22.0-14** for the approved series rated combinations available for the branch circuit breakers listed in **Table 22.6-2**.

The panelboards are listed and are marked with both the Underwriters Laboratories (UL) and Canadian Standards Association (CSA) labels.

Technical Data and Specifications

Bussing

100–400 A: Tin-plated aluminum is standard, copper is available as an option.

Boxes

Fits existing box depths from 4.50 (114.3 mm) to 6.00 inches (152.4 mm) deep.

Optional mounting brackets are available if existing enclosure exceeds 6.00 inches (152.4 mm) deep.

Boxes shallower than standard may require special collar adapters.

Trims

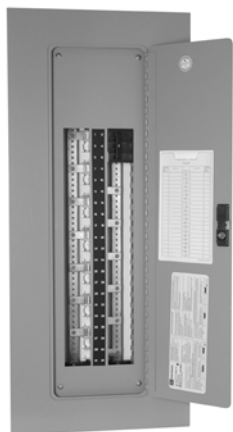

Pow-R-Line 1R

The trim and door is designed to attach directly to the panelboard deadfront assembly so that there is no external trim-fastening hardware required.

The interior backpan or optional mounting plates are fastened directly to the back of the existing enclosure using the hardware provided.

Neutral and Ground Bus

- Integrally mounted Neutral assembly
- Ground bar and bonding conductor included
- Neutral and Ground convertible from left-right
- Insulated/Isolated ground bus is available as an option
- Aluminum is standard, copper is available as an option

Application Guidelines

The following dimensions and data are necessary for production of a panelboard to fit an existing box:

Existing Flush-Mounted Box

- Height dimension H
- Width dimension W
- Depth dimension D
- Flange width dimension F
- If box is not flush with plaster line, dimension E

Existing Surface-Mounted Box

- Height dimension H
- Width dimension W
- Depth dimension D
- Flange width dimension may be F or FF as appropriate:
 - Flange width dimension F
 - Flange width dimension FF

Stud Locations

In most applications, the existing mounting hardware in the enclosure may be removed, but in some areas, the backpan may need to be attached using a minimum of one existing mounting stud to meet local code requirements for grounding. Confirm with your local electrical code authority having jurisdiction.

Stud location dimensions: A _____, B _____ and C _____.

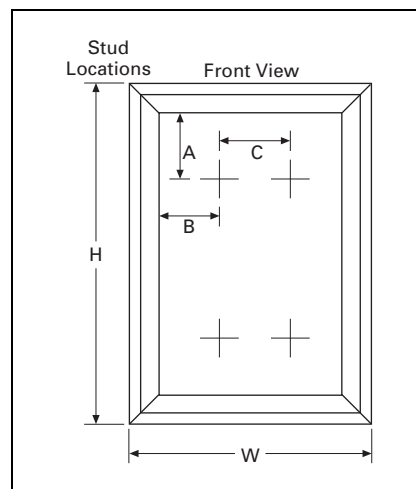

Figure 22.6-1. Existing Interior Mounting Studs

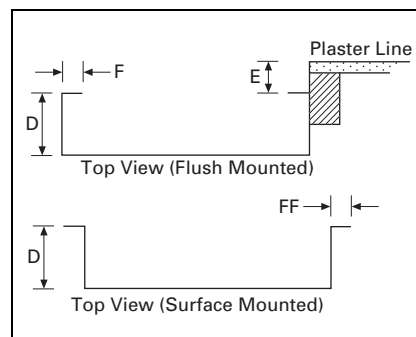

Figure 22.6-2. Existing Box Top View

Table 22.6-3. Minimum Enclosure Sizing

Ampere Rating	Number of Circuits	Main Device Type	Minimum Enclosure Dimensions Inches (mm)		
			Height	Width	Depth
Main Lug Only					
100	18	MLO	21.00 (533.4)	14.00 (355.6)	4.50 (114.3)
	30		27.00 (685.8)	14.00 (355.6)	4.50 (114.3)
	42		34.00 (863.6)	14.00 (355.6)	4.50 (114.3)
225	18	MLO	21.00 (533.4)	14.00 (355.6)	4.50 (114.3)
	30		27.00 (685.8)	14.00 (355.6)	4.50 (114.3)
	42		34.00 (863.6)	14.00 (355.6)	4.50 (114.3)
400	18	MLO	21.00 (533.4)	14.00 (355.6)	4.50 (114.3)
	30		27.00 (685.8)	14.00 (355.6)	4.50 (114.3)
	42		34.00 (863.6)	14.00 (355.6)	4.50 (114.3)
Main Breaker					
100	18	BAB, QBHW	21.00 (533.4)	14.00 (355.6)	4.50 (114.3)
			27.00 (685.8)	14.00 (355.6)	4.50 (114.3)
			34.00 (863.6)	14.00 (355.6)	4.50 (114.3)
	30	EHD, ED, EDH, FDB, FD, HFD, EDB, EDC, EDS	30.00 (762.0)	14.00 (355.6)	4.50 (114.3)
			36.00 (914.4)	14.00 (355.6)	4.50 (114.3)
			42.00 (1066.8)	14.00 (355.6)	4.50 (114.3)
225	18	ED, EDH, EDB, EDS, EDC, FD, HFD, FDC	30.00 (762.0)	14.00 (355.6)	4.50 (114.3)
			36.00 (914.4)	14.00 (355.6)	4.50 (114.3)
			42.00 (1066.8)	14.00 (355.6)	4.50 (114.3)

Pow-R-Line 2R Retrofit Panelboard



Pow-R-Line 2R

General Description

Panelboard Ratings

Voltage

- 240 Vac
- 480Y/277 Vac maximum

Main Lugs

- 100–225 A

Main Breakers

- 100–225 A

Branch Breakers

- 15–100 A (bolt-on chassis)

Short-Circuit Current Ratings (Symmetrical)

- 240 Vac: 10 kA and 22 kA fully rated
- 240 Vac: 22–200 kA series rated

Service

- Three-phase, four-wire 480Y/277 Vac
- Three-phase, four-wire 208Y/120 Vac and 240/120 Vac delta
- Single-phase, three-wire 120/240 Vac
- Single-phase, two-wire 120 Vac
- Three-phase, three-wire 208 and 240 Vac

Suitable for service entrance applications when specified.

Mains

For available mains, refer to **Table 22.6-4**.

Main breakers, 100 A, Type GHB is horizontally mounted, same as branch breakers. All other main breakers are vertically mounted.

Branch Circuits

For available branch devices, refer to **Table 22.6-5**.

Eaton offers a factory-assembled panelboard interior and trim designed to bolt directly into an existing enclosure.

Custom-built panelboard interiors and trims can be provided to retrofit most any manufacturer's existing panelboard enclosure.

The panelboards are listed and are marked with both the Underwriters Laboratories (UL) and Canadian Standards Association (CSA) labels.

Why Retrofit?

- Upgrade protective device interrupting ratings
- Replacing old, obsolete circuit breakers with new
- Providing additional circuits for load growth
- Accommodating system change and additions
- Adding ground fault circuit interrupters

Immediate Benefits

- Installation time is dramatically reduced
- Disruption of existing power service is minimal
- Less cleanup and wall repair because there is no need to cut and break concrete or finished wall surface

Main Lugs Only

The short-circuit rating of the MLO assembled panelboard will be fully rated based upon the lowest rated branch device, or may be series rated with an approved upstream device.

Main lugs only ampere ratings: 100 and 225.

Main Circuit Breakers

The short-circuit rating shown is that of the main breaker only. The short-circuit rating of the assembled panelboard is the rating of the lowest fully rated main or branch device, or the rating of an approved series rated combination.

Table 22.6-4. Main Circuit Breakers

Breaker Frame Amperes	Breaker Type	Interrupting Rating (kA Symmetrical)	
		240 Vac	480Y/277 Vac
100	GHB	65	14
150	FDB	18	14
225	FDB	65	35
225	HFD	100	65
225	FDC	200	100

Table 22.6-5. Branch Circuit Breakers

Breaker Type	Ampere Rating	Number of Poles	Interrupting Rating (kA Symmetrical)			
			120 Vac	240 Vac	277 Vac	480Y/277 Vac
GHQ	15–20	1	65	—	14	—
GHB	15–100	1	65	—	14	—
GHB	15–100	2, 3	—	65	—	14
GHB-HID ^①	15–20	1	65	—	14	—
GHBGFEP ^②	15–60	1	65	—	14	—
HGHB	15–30	1	65	—	25	—

^① HID (High Intensity Discharge) rated breaker.

^② GHB breaker with 30 ma equipment ground fault protection.

Series Rated Combinations

Refer to series rating tables beginning on **Page 22.0-14** for the approved series rated combinations available for the branch circuit breakers listed in **Table 22.6-5**.

The panelboards are listed and are marked with both the Underwriters Laboratories (UL) and Canadian Standards Association (CSA) labels.

Technical Data and Specifications

Bussing

100–225 A: Tin-plated aluminum is standard, copper is available as an option.

Boxes

Fits existing box depths from 4.50 (114.3 mm) to 6.00 inches (152.4 mm) deep.

Optional mounting brackets are available if existing enclosure exceeds 6.00 inches (152.4 mm) deep.

Boxes shallower than standard may require special collar adapters.

Trims



Pow-R-Line 2R

The trim and door is designed to attach directly to the panelboard deadfront assembly so that there is no external trim-fastening hardware required.

The interior backpan or optional mounting plates are fastened directly to the back of the existing enclosure using the hardware provided.

Neutral and Ground Bus

- Integrally mounted Neutral assembly
- Ground bar and bonding conductor included
- Neutral and Ground convertible from left-right
- Insulated/Isolated ground bus is available as an option
- Aluminum is standard, copper is available as an option

Application Guidelines

The following dimensions and data are necessary for production of a panelboard to fit an existing box:

Existing Flush-Mounted Box

- Height dimension H
- Width dimension W
- Depth dimension D
- Flange width dimension F
- If box is not flush with plaster line, dimension E

Existing Surface-Mounted Box

- Height dimension H
- Width dimension W
- Depth dimension D
- Flange width dimension may be F or FF as appropriate:
 - Flange width dimension F
 - Flange width dimension FF

Stud Locations

In most applications, the existing mounting hardware in the enclosure may be removed, but in some areas, the backpan may need to be attached using a minimum of one existing mounting stud to meet local code requirements for grounding. Confirm with your local electrical code authority having jurisdiction.

Stud location dimensions: A _____, B _____ and C _____.

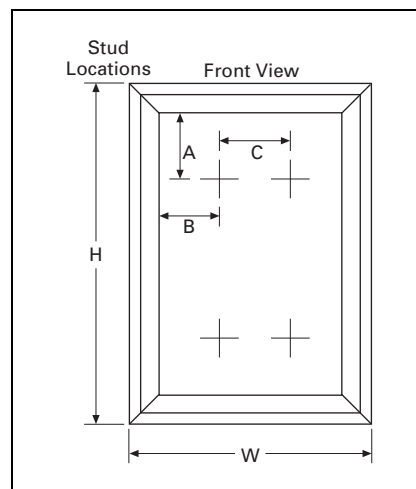

Figure 22.6-3. Existing Interior Mounting Studs

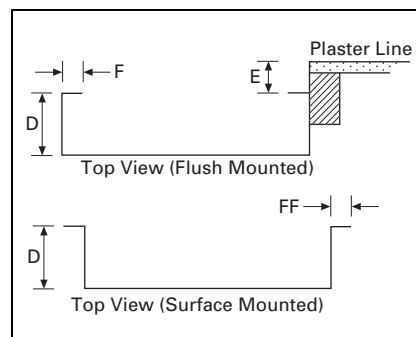

Figure 22.6-4. Existing Box Top View

Table 22.6-6. Minimum Enclosure Sizing

Ampere Rating	Number of Circuits	Main Device Type	Minimum Enclosure Dimensions Inches (mm)		
			Height	Width	Depth
Main Lug Only					
100	18	MLO	21.00 (533.4)	14.00 (355.6)	4.50 (114.3)
	30		27.00 (685.8)	14.00 (355.6)	4.50 (114.3)
	42		34.00 (863.6)	14.00 (355.6)	4.50 (114.3)
225	18	MLO	21.00 (533.4)	14.00 (355.6)	4.50 (114.3)
	30		27.00 (685.8)	14.00 (355.6)	4.50 (114.3)
	42		34.00 (863.6)	14.00 (355.6)	4.50 (114.3)
Main Breaker					
100	18	GHB	21.00 (533.4)	14.00 (355.6)	4.50 (114.3)
			27.00 (685.8)	14.00 (355.6)	4.50 (114.3)
			34.00 (863.6)	14.00 (355.6)	4.50 (114.3)
	30	FDB, FD, HFD, FDC	30.00 (762.0)	14.00 (355.6)	4.50 (114.3)
			36.00 (914.4)	14.00 (355.6)	4.50 (114.3)
			42.00 (1066.8)	14.00 (355.6)	4.50 (114.3)
225	18	FD, HFD, FDC	30.00 (762.0)	14.00 (355.6)	4.50 (114.3)
			36.00 (914.4)	14.00 (355.6)	4.50 (114.3)
			42.00 (1066.8)	14.00 (355.6)	4.50 (114.3)

Pow-R-Line 1aF



Pow-R-Line 1aF

General Description

Panelboard Ratings

Voltage

- 240 Vac maximum

Main Lugs

- 100–400 A

Main Breakers

- 100–400 A

Branch Devices

- 30 A
- Hybrid breaker and fuse
- Class “CC” fuses, 30 A maximum

Short-Circuit Current Ratings (Symmetrical)

- 240 Vac: 200 kA fully rated

Service

- Three-phase, four-wire 208Y/120 V and 240/120 V delta
- Single-phase, three-wire 120/240 V
- Single-phase, two-wire 120 V
- Three-phase, three-wire 208 and 240 V

Suitable for service entrance applications when specified.

Mains

For available mains, refer to **Table 22.6-7**.

Main breakers are vertically mounted.

Branch Circuits

For available branch devices, refer to **Table 22.6-8**.

Application Description

For use on high fault current systems requiring lighting panels, selectively coordinated systems and laboratories and testing stations where overcurrent protection below 15A is required.

Main Lugs Only

The short-circuit rating of the MLO assembled panelboard will be fully rated based upon the upstream device.

Main lugs only ampere ratings: 100, 225 and 400.

Main Circuit Breakers

The short-circuit rating shown is that of the main breaker only. The short circuit rating of the assembled panelboard is the rating of the lowest fully rated main or branch device or the rating of an approved series rated combination

Table 22.6-7. Main Circuit Breakers

Breaker Frame Amperes	Breaker Type	Interrupting Rating (kA Symmetrical) at 240 Vac
100	EDB	22
100	EDS	42
100	ED	65
100	FD	65
100	FDE	65
100	EDH	100
100	HFD	100
100	HFDE	100
225	EDB	22
225	EDS	42
225	ED	65
225	FD	65
225	FDE	65
225	EDH	100
225	HFD	100
225	HFDE	100
400	DK	42
400	KD	65
400	HKD	100
400	KDC	200
400	LHH	200

Table 22.6-8. Branch Overcurrent Devices
Hybrid breaker/fuse (Class CC) branch device ①

Ampere Rating	Interrupting Rating	Breaker Type
30	200	Hybrid

① Class “CC” fuses are required, 30A maximum. Fuses are not supplied by Eaton.

Technical Data and Specifications

Bussing

100–400 A: Tin-plated aluminum is standard, copper is available as an option.

Boxes

Boxes are made from code-gauge galvanized steel.

Blank ends are supplied as standard, knockouts are available upon request.

Trim

Trims are made from code-gauge steel and painted ANSI 61 gray Type YS.

Modifications

Table 22.6-9. Through-Feed Lugs

Ampere Rating	Information
100 225 400	See Table 22.6-14 See Table 22.6-14 See Table 22.6-14

Ground Bar

Standard bolted in box. Aluminum is standard, copper is available as an option.

Enclosures

Type 1.

Box Sizing and Selection

Box size for all Type 1 panelboards are available from **Table 22.6-10**.

Instructions

1. Select the rating and type of mains required.
2. Count total number of branch circuit poles (including spaces) required in the panelboard. Do not count main breaker poles.

3. Using correct table, type of mains and ampere rating per Step 1, find total number of poles.

Note: Where total number of poles (Step 2) fall between number in table, use the next higher number.

4. Read box size across columns to the right.

Top and Bottom Gutters (minimum)

5.50 inches (139.7 mm).

Side Gutters

28.00-inch (508.0 mm) wide box:

6.50 inches (165.1 mm).

Table 22.6-10. Type 1 Panelboards—Dimensions in Inches (mm)

Ampere Rating of Mains	Main Breaker Type Mounting Position	Maximum Number of Branch Circuits Including Provisions	Box Dimensions		
			Height	Width	Depth
100 A					
100 A Main lugs or main breaker	EHD, FDB, FD, FDE, HFD, FDC, HFDE Vertical	18	36.00 (914.4)	28.00 (711.2)	5.75 (146.1)
		30	48.00 (1219.2)	28.00 (711.2)	5.75 (146.1)
		42	48.00 (1219.2)	28.00 (711.2)	5.75 (146.1)
		48	60.00 (1524.0)	28.00 (711.2)	5.75 (146.1)
100 A Main lugs or main breaker with 100A through-feed lugs	EHD, FDB, FD, FDE, HFD, FDC, HFDE Vertical	18	48.00 (1219.2)	28.00 (711.2)	5.75 (146.1)
		30	48.00 (1219.2)	28.00 (711.2)	5.75 (146.1)
		42	60.00 (1524.0)	28.00 (711.2)	5.75 (146.1)
		48	60.00 (1524.0)	28.00 (711.2)	5.75 (146.1)
225 A					
225 A Main lugs or main breaker	EDB, EDS, ED, EDH, EDC, FD, HFD, FDC, FDE, HFDE Vertical	18	36.00 (914.4)	28.00 (711.2)	5.75 (146.1)
		30	48.00 (1219.2)	28.00 (711.2)	5.75 (146.1)
		42	48.00 (1219.2)	28.00 (711.2)	5.75 (146.1)
		48	60.00 (1524.0)	28.00 (711.2)	5.75 (146.1)
225 A Main lugs or main breaker with 225 or 100 A through-feed lugs	EHD, FDB, FD, HFD, FDE FDC, EDB, EDS, HFDE ED, EDH, EDC Vertical	18	48.00 (1219.2)	28.00 (711.2)	5.75 (146.1)
		30	48.00 (1219.2)	28.00 (711.2)	5.75 (146.1)
		42	60.00 (1524.0)	28.00 (711.2)	5.75 (146.1)
		48	60.00 (1524.0)	28.00 (711.2)	5.75 (146.1)
400 A					
400 A Main lugs or main breaker	DK, KD, HKD, KDC, LHH Vertical	18	60.00 (1524.0)	28.00 (711.2)	5.75 (146.1)
		30	60.00 (1524.0)	28.00 (711.2)	5.75 (146.1)
		42	72.00 (1828.8)	28.00 (711.2)	5.75 (146.1)
		48	72.00 (1828.8)	28.00 (711.2)	5.75 (146.1)

Pow-R-Line 2aF



Pow-R-Line 2aF

General Description

Panelboard Ratings

Voltage

- 240 Vac
- 480Y/277 Vac maximum

Main Lugs

- 100–400 A

Main Breakers

- 100–400 A

Branch Devices

- 30 A (bolt-on)
- Hybrid breaker and fuse
- Class “CC” fuses, 30 A maximum

Short-Circuit Current Ratings (Symmetrical)

- 480Y/277 Vac: 200 kA fully rated

Service

- Three-phase, four-wire 480Y/277 V

Suitable for service entrance applications when specified.

Application Description

For use on high fault current systems requiring lighting panels, selectively coordinated systems and laboratories and testing stations where overcurrent protection below 15 A is required.

Mains

For available mains, refer to **Table 22.6-11**.

Branch Circuits

For available branch devices, refer to **Table 22.6-12**.

Main Lugs Only

The short-circuit rating of the MLO assembled panelboard will be fully rated based upon the lowest rated branch device or may be series rated with an approved upstream device.

Main lugs only ampere ratings: 100, 225 and 400.

Main Circuit Breakers

The short-circuit rating shown is that of the main breaker only. The short-circuit rating of the assembled panelboard is the rating of the lowest fully rated main or branch device or the rating of an approved series rated combination.

Table 22.6-11. Main Circuit Breakers

Breaker Frame Amperes	Breaker Type	Interrupting Rating (kA Symmetrical) at 480Y/277 Vac
100	FD, FDE	35
100	HFD, HFDE	65
100	FDC	100
225	FD, FDE	35
225	HFD, HFDE	65
225	FDC, HFDE	100
400	KD	35
400	HKD	65
400	KDC	100
400	LHH	100

Table 22.6-12. Branch Overcurrent Devices Hybrid breaker/fuse (Class CC) branch device ①

Ampere Rating	Interrupting Rating	Breaker Type
30	200	Hybrid

① Class “CC” fuses are required, 30A maximum. Fuses are not supplied by Eaton.

Technical Data and Specifications

Bussing

100–400 A: Tin-plated aluminum is standard, copper is available as an option.

Boxes

Boxes are made from code-gauge galvanized steel.

Blank ends are supplied as standard, knockouts are available upon request.

Trim

Trims are made from code-gauge steel and painted ANSI 61 gray, Type YS.

Modifications

Table 22.6-13. Through-Feed Lugs

Ampere Rating	Information
100	See Table 22.6-14
225	See Table 22.6-14
400	See Table 22.6-14

Ground Bar

Standard bolted in box. Aluminum is standard. Copper is available as an option.

Enclosures

Type 1.

Box Sizing and Selection

Box size for all Type 1 panelboards are available from **Table 22.6-14**.

Instructions

- Using description on the required panelboard, select the rating and type of mains required.
- Count total number of branch circuit poles (including spaces) required in the panelboard. Do not count main breaker poles.

- Using correct table, type of mains and ampere rating per Step 1, find total number of poles.

Note: Where total number of poles (Step 2) fall between number in table, use the next higher number.

- Read box size across columns to the right.

Top and Bottom Gutters (Minimum)

5.50 inches (139.7 mm).

Side Gutters

20.00-inch (508.0 mm) wide box:
5.50 inches (139.7 mm).

Table 22.6-14. Type 1 Panelboards—Dimensions in Inches (mm)

Ampere Rating of Mains	Main Breaker Type Mounting Position	Maximum Number of Branch Circuits Including Provisions	Box Dimensions			
			Height	Width	Depth	
100 A Panelboards						
100 A Main lugs or main breaker	FDB, FD, FDE HFD, FDC, HFDE Vertical	18	36.00 (914.4)	28.00 (711.2)	5.75 (146.1)	
		30	48.00 (1219.2)	28.00 (711.2)	5.75 (146.1)	
		42	48.00 (1219.2)	28.00 (711.2)	5.75 (146.1)	
		48	60.00 (1524.0)	28.00 (711.2)	5.75 (146.1)	
100 A Main lugs or main breaker with 100 A through-feed lugs	FDB, FD, FDE HFD, FDC, HFDE Vertical	18	48.00 (1219.2)	28.00 (711.2)	5.75 (146.1)	
		30	48.00 (1219.2)	28.00 (711.2)	5.75 (146.1)	
		42	60.00 (1524.0)	28.00 (711.2)	5.75 (146.1)	
		48	60.00 (1524.0)	28.00 (711.2)	5.75 (146.1)	
225 A Panelboards						
225 A Main lugs or main breaker	FD, HFD, FDC, FDE, HFDE Vertical	18	36.00 (914.4)	28.00 (711.2)	5.75 (146.1)	
		30	48.00 (1219.2)	28.00 (711.2)	5.75 (146.1)	
		42	48.00 (1219.2)	28.00 (711.2)	5.75 (146.1)	
		48	60.00 (1524.0)	28.00 (711.2)	5.75 (146.1)	
225 A Main lugs or main breaker with 100 A through-feed lugs	FDB, FD, FDE HFD, FDC, HFDE Vertical	18	48.00 (1219.2)	28.00 (711.2)	5.75 (146.1)	
		30	48.00 (1219.2)	28.00 (711.2)	5.75 (146.1)	
		42	60.00 (1524.0)	28.00 (711.2)	5.75 (146.1)	
		48	60.00 (1524.0)	28.00 (711.2)	5.75 (146.1)	
400 A Panelboards						
400 A Main lugs or main breaker	DK, KD, HKD, KDC, LHH Vertical	18	60.00 (1524.0)	28.00 (711.2)	5.75 (146.1)	
		30	60.00 (1524.0)	28.00 (711.2)	5.75 (146.1)	
		42	72.00 (1828.8)	28.00 (711.2)	5.75 (146.1)	
		48	72.00 (1828.8)	28.00 (711.2)	5.75 (146.1)	
400 A Main lugs or main breaker with 100 A through-feed lugs	DK, KD, LHH HKD, KDC Vertical	Main	18	60.00 (1524.0)	28.00 (711.2)	5.75 (146.1)
			30	72.00 (1828.8)	28.00 (711.2)	5.75 (146.1)
			42	72.00 (1828.8)	28.00 (711.2)	5.75 (146.1)
			48	90.00 (2286.0)	28.00 (711.2)	5.75 (146.1)

Pow-R-Line 3FQS



Pow-R-Line 3FQS

General Description

The Pow-R-Line 3FQS is a fusible lighting panel designed for high fault current applications where circuit breakers may not meet the application. This panel is ideal when the selective coordination mandates apply. Designed for use with Eaton's Bussmann CUBEFuse®, the panel will selectively coordinate with the maximum available fault current. The PRL 3FQS is ideal for control circuits below 15 A.

Panelboard Ratings

Listings

- UL 67 panelboard chassis
- UL 50 listed box and trim
- UL 98 listed fusible switches

Voltage

- 600 Vac maximum
- 125 Vdc maximum (80A maximum branch)

Mains

- Main lugs: 30–400 A
- Main fusible switch: 30–400 A
- Main non-fused switch: 30–400 A

Voltage Systems

- 120 V, single-phase, two-wire
- 240 V, single-phase, two-wire
- 240 V, single-phase, two-wire—no neutral
- 277 V, single-phase, two-wire
- 120/240 V, single-phase, three-wire
- 208/120 V, single-phase, three-wire
- 480/240 V, single-phase, three-wire
- 277/480 V, single-phase, three-wire
- 480 V, single-phase, two-wire—no neutral

- 240 V, three-phase, three-wire
- 480 V, three-phase, three-wire
- 600 V, three-phase, three-wire
- 208/120 V, three-phase, four-wire
- 480/277 V, three-phase, four-wire
- 600/347 V, three-phase, four-wire
- 240/120 V, three-phase, four-wire
- 480/240 V, three-phase, four-wire
- 120/240 Vac, single-phase, three-wire
- 208Y/120 Vac, three-phase, four-wire
- 240 delta/120 Vac, three-phase, four-wire
- 480Y/277 Vac, three-phase, four-wire
- 600Y/347 Vac, three-phase, four-wire
- 240 delta Vac, three-phase, three-wire
- 480 delta Vac, three-phase, three-wire
- 600 delta Vac, three-phase, three-wire
- 25 Vdc

Branch Overcurrent Devices

- Eaton Bussmann Type CCPB (compact circuit protector base)
- 15–100 A
- Single-, two- and three-pole
- Branch fuses: Bussmann TCF or FCF CUBEFuse

Short-Circuit Current Ratings

- 50 kAIC symmetrical standard
- Up to 200 kAIC symmetrical when appropriate upstream overcurrent device is applied

Main Bus and Branch Connectors

- Tin plated, copper bus and branch connectors

Enclosures

- NEMA Type 1
- NEMA Type 3R

Branch Circuit Spaces

- 18, 30 and 42 circuit chassis

Incoming Line

- Top or bottom

Spare Fuse Compartment

- Provisions for six spare CUBEFuses, standard

Seismic Qualifications

Qualified for International Building Code (IBC) categories and site class A, B, C and D.

Application Description

- Hospitals
- Surgery centers
- Emergency systems
- Fire stations
- Police stations
- Laboratories

- Communication systems
- Ventilation and smoke removal systems
- Critical industrial processes
- Data centers
- Other critical or sensitive loads

Technical Data and Specifications

Table 22.6-15. Main Lugs Only

Ampere Rating	Standard Mechanical Lug Wire Range
100	(1) #1–300 kcmil
200	(1) #1–300 kcmil
400	(1) #4–600 kcmil

Table 22.6-16. Main Fused Switch (Class J Fuses Only)

Ampere Rating	Standard Mechanical Lug Wire Range
100	(1) #1–300 kcmil
200	(1) #1–300 kcmil
400	(1) #4–600 kcmil

Table 22.6-17. Main Non-Fused Switch

Ampere Rating	Standard Mechanical Lug Wire Range
100	(1) #1–300 kcmil
200	(1) #1–300 kcmil
400	(1) #4–600 kcmil



Branch Disconnects

Options

Loadside Chassis

- Feed-thru lugs
- Sub-feed lugs
- Sub-feed fused switch
- Surge protective device

Service Equipment

- Labeled suitable for use as service equipment (bonded neutral)

Neutrals

- Isolated neutral
- Bonded neutral
- 200% rated neutrals

Ground Bars

- Bonded neutral
- Isolated neutral

Special Trims

- Door-in-door
- No trim

Table 22.6-18. Branch Circuit Disconnects Compact Circuit Protector Base (CCPB)

CCPB ① Part Number	Number of Poles	Fuse Ampere Range	Maximum CCPB Ampacity	Non-Indicating Fuses (Standard)	Indicating Fuses (Optional) ②
CCPB-1-15CF	1	1–15	15	TCF1RN, TCF3RN, TCF6RN, TCF10RN, TCF15RN	TCF6, TCF10, TCF15
CCPB-2-15CF	2	1–15	15		
CCPB-3-15CF	3	1–15	15		
CCPB-1-20CF	1	17.5–20	20	TCF17-1/2RN, TCF20RN	TCF17-1/2, TCF20
CCPB-2-20CF	2	17.5–20	20		
CCPB-3-20CF	3	17.5–20	20		
CCPB-1-30CF	1	25–30	30	TCF25RN, TCF30RN	TCF25, TCF30
CCPB-2-30CF	2	25–30	30		
CCPB-3-30CF	3	25–30	30		
CCPB-1-40CF	1	35–40	40	TCF35RN, TCF40RN	TCF35, TCF40
CCPB-2-40CF	2	35–40	40		
CCPB-3-40CF	3	35–40	40		
CCPB-1-50CF	1	45–50	50	TCF45RN, TCF50RN	TCF45, TCF50
CCPB-2-50CF	2	45–50	50		
CCPB-3-50CF	3	45–50	50		
CCPB-1-60CF	1	60	60	TCF60RN	TCF60
CCPB-2-60CF	2	60	60		
CCPB-3-60CF	3	60	60		
CCPB-1-70CF 1	1	70	70	TCF70RN	TCF70
CCPB-2-70CF 2	2	70	70		
CCPB-3-70CF 3†	3	70	70		
CCPB-1-90CF	1	80–90	90	TCF80RN, TCF90RN	TCF80, TCF90
CCPB-2-90CF	2	80–90	90		
CCPB-3-90CF	3	80–90	90		
CCPB-1-100CF	1	100	100	TCF100RN	TCF100
CCPB-2-100CF	2	100	100		
CCPB-3-100CF	3	100	100		

① CCPB disconnect can accept CUBEFuses with ampere ratings less than or equal to the ampere rating of the CCPB disconnect.

② Correct fit with CCPB disconnect requires indicating CUBEFuses with date code R38 or later.

Note: Spare or replacement CCPB available only from authorized Eaton Bussmann distributors.

NEMA Type 1 Box Options

- No knockouts (standard)
- Knockouts, both top and bottom (optional)
- Knockouts, top or bottom (optional)

Replacement Fuses

- Replace only with Bussmann fuses of the same type and size
- Contact your authorized Eaton Bussmann distributor for replacement fuses
- Nameplates
- Permanent circuit numbering

Box Sizing and Selection

Enclosures

NEMA Type 1 Indoor

- Flush mount or surface mount
- Galvanized steel with removable end walls—blank or with knockouts (specify on order)

Table 22.6-19. NEMA Type 1 Box Sizes—Dimensions in Inches (mm)

Width	Depth	Height
20.00 (508.0)	5.75 (146.1)	33.00 (838.2)
20.00 (508.0)	5.75 (146.1)	50.00 (1270.0)
20.00 (508.0)	5.75 (146.1)	59.00 (1498.6)
20.00 (508.0)	5.75 (146.1)	69.00 (1752.6)

- Chassis mounts directly onto enclosure studs in the enclosure
- Trim finished with gray powder coat paint over phosphatized steel (ANSI 61) with door
- Circuit directory card is located on the inside of the door
- Concealed trim screws

NEMA Type 3R Outdoor (Optional)

- Surface mount only
- Finished with gray powder coat paint over phosphatized steel (ANSI 61)
- Bottom feed only, no knockouts

Table 22.6-20. NEMA Type 3R Outdoor Box Sizes—Dimensions in Inches (mm)

Width	Depth	Height
20.00 (508.0)	7.75 (196.9)	34.50 (876.3)
20.00 (508.0)	7.75 (196.9)	51.50 (1308.1)
20.00 (508.0)	7.75 (196.9)	60.50 (1536.7)
20.00 (508.0)	7.75 (196.9)	70.50 (1790.7)

- Chassis mounts directly onto studs in the enclosure
- Gasketed door has vault handle with lock
- Circuit directory card is located on the inside of the door
- Contact Eaton for other enclosure types

Table 22.6-21. CCPB Horsepower Ratings

CCPB Disconnect	Ampere Rating	Horsepower Rating at Vac			
		120	240	480	600
CCPB–(Poles)–15CF	15	0.5	3	5	7.5
CCPB–(Poles)–20CF	20	0.75	3	7.5	10
CCPB–(Poles)–30CF	30	1.5	5	15	10
CCPB–(Poles)–40CF	40	2	7.5	20	10
CCPB–(Poles)–50CF	50	3	7.5	20	10
CCPB–(Poles)–60CF	60	3	7.5	20	10
CCPB–(Poles)–70CF	70	3	15	30	40
CCPB–(Poles)–90CF	80	5	20	40	50
CCPB–(Poles)–100CF	100	5	20	50	50

Elevator Control Panelboard



Elevator Control Panelboard

General Description

Ratings

- 240 Vac and 600 Vac
- Three-phase, three-wire and three-phase, four-wire
- 200 kA short-circuit current ratings

Main Lugs Only

- 800 A maximum

Branch Devices

- 30–200 A, 240 Vac and 600 Vac fused switch to feed the elevator

Elevator Controls Standard Features

- Factory wired from switch to controls
- 200 kA rms short-circuit current rating
- 120 Vac shunt trip
- Ground termination
- Branch fusible switch
- Class J fuse clips on switch (fuses not included)
- 100 VA Control Power Transformer (CPT) with 120 Vac secondary
- CPT primary and secondary fusing
- Selection of primary CPT voltages
- Fire safety interface relay with user-selected coil voltage
- Fire alarm voltage monitoring relay
- Keyed test switch
- “ON” pilot light; user selects color

Standards

- The Elevator Control Panelboard meets and is listed to the following standards:
 - UL 67 listed panelboard
 - UL 50 listed enclosure
 - UL 98 listed fusible elevator control fusible switches

Options

- Integrated Surge Protective Device (SPD) 100–400 kA
- Specialized control to meet local codes

Application Description

The Elevator Control Panelboard is designed to replace multiple components provided in elevator control rooms, thus consolidating and standardizing this area. With the ability to control up to four elevators in a common shaft, the Elevator Control Panelboard offers the needed controls in a space-saving design while allowing access by the various trades involved with the installation.

Not only does the Elevator Control Panelboard provide electrical feeds, it also contains necessary components for the control of the elevator and the fire alarm system.

Codes

The Elevator Control Panelboard is designed to meet the following codes:

- NFPA 70 (National Electrical Code)
- NFPA 72 (National Fire Alarm Code)
- ANSI/ASME A17.1 (Safety Code for Elevators and Escalators)
- NFPA 13 (Installation of Sprinkler Systems)

Selective Coordination

Eaton’s Elevator Control Panelboard has superior selective coordination properties. When paired with the appropriate upstream fusing, the elevator control panelboard can selectively coordinate with higher fault current levels. All fuses must be of the same manufacturer. Consult the specific fuse manufacturer’s data for selective coordination values.

Surge Protective Device (SPD)

Surge Protective Devices (SPD) may be integrated into all Elevator Control Panelboards. Because most installation calls for SPDs, integrating an Eaton SPD ensures proper installation and significantly limits destructive let-through beyond all size-mounted solutions. Please see **Section 36** for more information.

Table 22.6-22. Elevator Feeder Devices

Ampere Rating	Fuse Class	Short-Circuit Current Rating (kAIC Symmetrical)	
		240 Vac	600 Vac
30	Class J	200	200
60	Class J	200	200
100	Class J	200	200
200	Class J	200	200

Table 22.6-23. Box Sizing and Selection—Dimensions in Inches (mm)

Ampere Rating	Number of Elevators	Dimensions			
		Without SPD		With SPD	
		Width	Height	Width	Height
400	2	40.00 (1016.0)	57.00 (1447.8)	40.00 (1016.0)	73.00 (1854.2)
	3	40.00 (1016.0)	57.00 (1447.8)	40.00 (1016.0)	73.00 (1854.2)
	4	40.00 (1016.0)	57.00 (1447.8)	40.00 (1016.0)	73.00 (1854.2)
600	2	40.00 (1016.0)	57.00 (1447.8)	40.00 (1016.0)	73.00 (1854.2)
	3	40.00 (1016.0)	57.00 (1447.8)	40.00 (1016.0)	73.00 (1854.2)
	4	40.00 (1016.0)	57.00 (1447.8)	40.00 (1016.0)	73.00 (1854.2)
800	3	40.00 (1016.0)	73.00 (1854.2)	40.00 (1016.0)	73.00 (1854.2)
	4	40.00 (1016.0)	73.00 (1854.2)	40.00 (1016.0)	73.00 (1854.2)

Note: Dimensions reflect NEMA Type 1 enclosures. All boxes are 11.31 inches (287.3 mm) deep.

Types PRL1a, 2a, 3a, 3E, 4 and Column Modifications



Types PRL1a, 2a, 3a, 3E, 4 and Column

Modifications Selection Guide

Table 22.6-24. Modifications—Alphabetical Index

Modification	Available on Panelboard Types						Column Type
	PRL1a	PRL2a	PRL3a	PRL3E	PRL4B	PRL4F	
Ambient compensating breakers	No	No	Yes	No	Yes	—	No
Bus density	Yes	Yes	Yes	Yes	Yes	Yes	Yes
Cabinets—special: Types 2, 3R, 4, 4X, 12	Yes	Yes	Yes	Yes	Yes	Yes	No
Complete assembly	Yes	Yes	Yes	Yes	Yes	Yes	Yes
Compression type lugs, mains only	Yes	Yes	Yes	Yes	Yes	Yes	Yes
Concealed trim clamps (LT trim)	Yes	Yes	Yes	Yes	No	No	No
Conduit covers	Yes	Yes	Yes	Yes	Yes	Yes	No
Copper lugs	Yes	Yes	Yes	Yes	Yes	Yes	Yes
Copper main bus	Yes	Yes	Yes	Yes	Yes	Yes	Standard
Directory frame—metal	Yes	Yes	Yes	Yes	Yes	Yes	No
Doors, special	Yes	Yes	Yes	Yes	Yes	Yes	Yes
Electronic trip units	No	No	No	Yes	Yes	—	No
Fungus-proof	Yes	Yes	Yes	Yes	Yes	Yes	Yes
Ground bar	Yes	Yes	Yes	Yes	Yes	Yes	Yes
Ground fault protection (zero sequence)	No	No	No	No	Yes	Yes	No
Handle lockoff device	Yes	Yes	Yes	Yes	Yes	Std.	Yes
Hinges, special (LT trim)	Yes	Yes	Yes	Yes	Yes	Yes	No
Increased dimensions	Yes	Yes	Yes	Yes	No	No	No
Increased panel bus rating	Yes	Yes	Yes	Yes	No	No	No
Interiors to fit existing boxes	Yes	Yes	Yes	Yes	Yes	Yes	No
Locks, special (LT trim)	Yes	Yes	Yes	Yes	Yes	Yes	No
Metering devices	No	No	No	Yes	Yes	Yes	No
Molded-case switches	Yes	Yes	Yes	Yes	Yes	No	Yes
Nameplates engraved	Yes	Yes	Yes	Yes	Yes	Yes	Yes

Table 22.6-24. Modifications—Alphabetical Index (Continued)

Modification	Available on Panelboard Types						
	PRL1a	PRL2a	PRL3a	PRL3E	PRL4B	PRL4F	Column Type
Neutral rated 200%	Yes	Yes	Yes	Yes	Yes	Yes	Yes
Painting and special coating	Yes	Yes	Yes	Yes	Yes	Yes	Yes
Permanent circuit numbers	Yes	Yes	Yes	Yes	Yes	Yes	Yes
Remote control switches (ASCO 920)	No	No	Yes	Yes	No	No	No
Service entrance	Yes	Yes	Yes	Yes	Yes	Yes	No
Shunt trips	Yes	Yes	Yes	Yes	Yes	Yes	Yes
Split bus or meter loop	No	No	Yes	No	No	No	No
Sub-feed breakers	Yes	Yes	Yes	Yes	No	No	Yes
Sub-feed lugs	Yes	Yes	Yes	Yes	Yes	Yes	No
Sub-metering, IQ Energy Sentinel	No	No	No	No	Yes	No	No
Surge protective device (SPD)	Yes	Yes	Yes	Yes	Yes	Yes	No
Tamperproof screws (LT trim)	Yes	Yes	Yes	Yes	Yes	Yes	Yes
Terminals, copper only for breakers	Yes	Yes	Yes	Yes	Yes	—	Yes
Through-feed lugs	Yes	Yes	Yes	Yes	Yes	Yes	Yes
Time clock space only	Yes	Yes	Yes	Yes	—	—	No
Touchup paint	Yes	Yes	Yes	Yes	Yes	Yes	Yes

This page intentionally left blank.