



# Cutler-Hammer

## Motor Control Center Type 5600 Series

Renewal Parts

ITE, Gould, Telemecanique  
and ITE Rowan MCCs

New Information

### Description

#### Motor Control Center Type 5600 Series

	<i>Page</i>
Distributor Ordering Instructions . . . . .	2
Procedure for Identifying MCC Renewal Units and Parts . . . . .	2
Identifying Motor Control Center Type . . . . .	3
Identification by Original MCC — ITE Rowan, Gould and Telemecanique. . . . .	3
5600 Series Product Description . . . . .	4
Replacement Starter Units . . . . .	5 – 9
Unit Options . . . . .	10 – 12
Replacement Feeder Units . . . . .	13
Unit Parts . . . . .	14 – 15

### Underwriters Laboratories Label

Eaton's Cutler-Hammer Type 5600 Series Motor Control Center (MCC) units have been designed and tested to meet UL® Standard 845, where applicable. Accordingly, all standard electrical devices will be UL listed or recognized. UL MCC unit labels cannot be supplied if special non-UL listed devices are required by order specifications.

Design includes NEMA® 1 gasketed unit. An ongoing temperature and short circuit design test program as required by UL 845 ensures a quality product that meets the latest safety codes.



## Identifying Motor Control Center Type

In most cases, it is possible to identify MCC design by handle type, starter type, stab, bucket or door width.

**Table 1. Identifying Motor Control Center Type**

MCC Type	Type of Handle Mechanism	Original MCC Starter Type	Bucket Width Inches (mm)	Door Width Inches (mm)	Starter Type (Installed in New Unit)
ITE® Rowan 5600	Lever/Rotating	ITE 5600	13-3/4 (349.3) Approx.	15-5/8 (397.0) ITE	Siemens®
Gould®	Lever/Rotating	Gould	13-3/4 (349.3) Approx.	15-5/8 (397.0) Gould	Siemens
Telemecanique®	Rotating	Telemecanique	13-3/4 (349.3) Approx.	15-5/8 (397.0) Telemecanique	Telemecanique

## Identification by Original MCC — ITE Rowan, Gould and Telemecanique

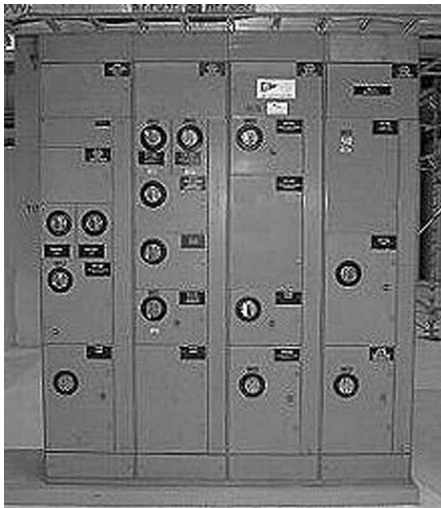

*ITE/Gould MCC*



*Gould Handle Mechanisms Cover Plate*



*Telemecanique Starter Unit*

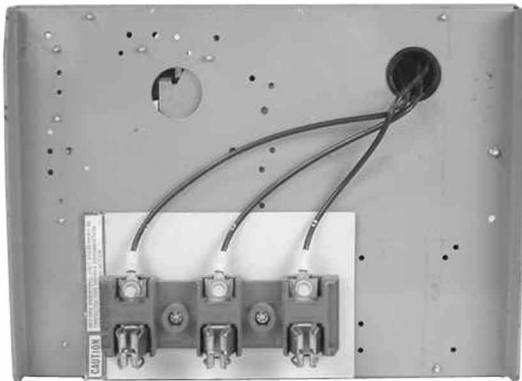

*Old 5600 Series Stab*

## New 5600 Series Product Description

All control units, removable or fixed mounted, are assembled with Cutler-Hammer components of proven safety, quality and reliability. All components are wired in accordance with NEMA and UL standards. Specifically designed bus stabs, insertion guides, handle mechanisms and safety interlocks are added to form a standardized plug-in cell that meets the highest safety standards.

Unit design includes NEMA 1 gasketed. An ongoing temperature and short circuit design test program as required by UL 845 ensures a quality product that meets the latest safety codes.

### Underwriters Laboratories

The 5600 Series MCC units have been designed and tested to meet UL Standard 845, where applicable. Accordingly, all standard electrical devices will be UL listed or recognized. UL MCC unit labels cannot be supplied if special non-UL listed devices are required by order specifications.

### Plug-in Unit Bus Stabs

A tin-plated copper alloy stab incorporates the ultimate in mechanical simplicity to provide precise control of contact pressure on the bus. This ensures a positive connection yet permits easy unit insertion and withdrawal. Units are mounted on a glass-reinforced plastic insulation block which totally protects each stab and absolutely ensures positive alignment of the stab with the vertical bus. The insulation block is also an integral part of the phase-to-phase isolation system. Power wiring is welded to the stabs and assemblies are accurately matched to the electrical requirements of each individual unit which are provided in units up to 250 ampere ratings.

The Cutler-Hammer MCC Product Line used state-of-the-art 3D AutoCAD to develop and design the 5600 Series MCC bucket. This method not only provides the ability to make changes to one part of the assembly, which will automatically update the other effected parts, but it ensures the additional quality for matching the parts during the assembly of the unit. This type of technology is just what the customer is demanding from their suppliers. The Cutler-Hammer business is leading our competition, providing nothing but the best for our customers.

The stab block has been moved to the top of the wrapper to eliminate cable flexing and possible damage and/or shorting, as well as decreased temperature rise on the cable/stab configuration.

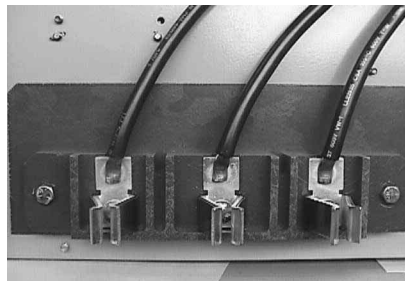

UL 845 Certified Stab Assembly

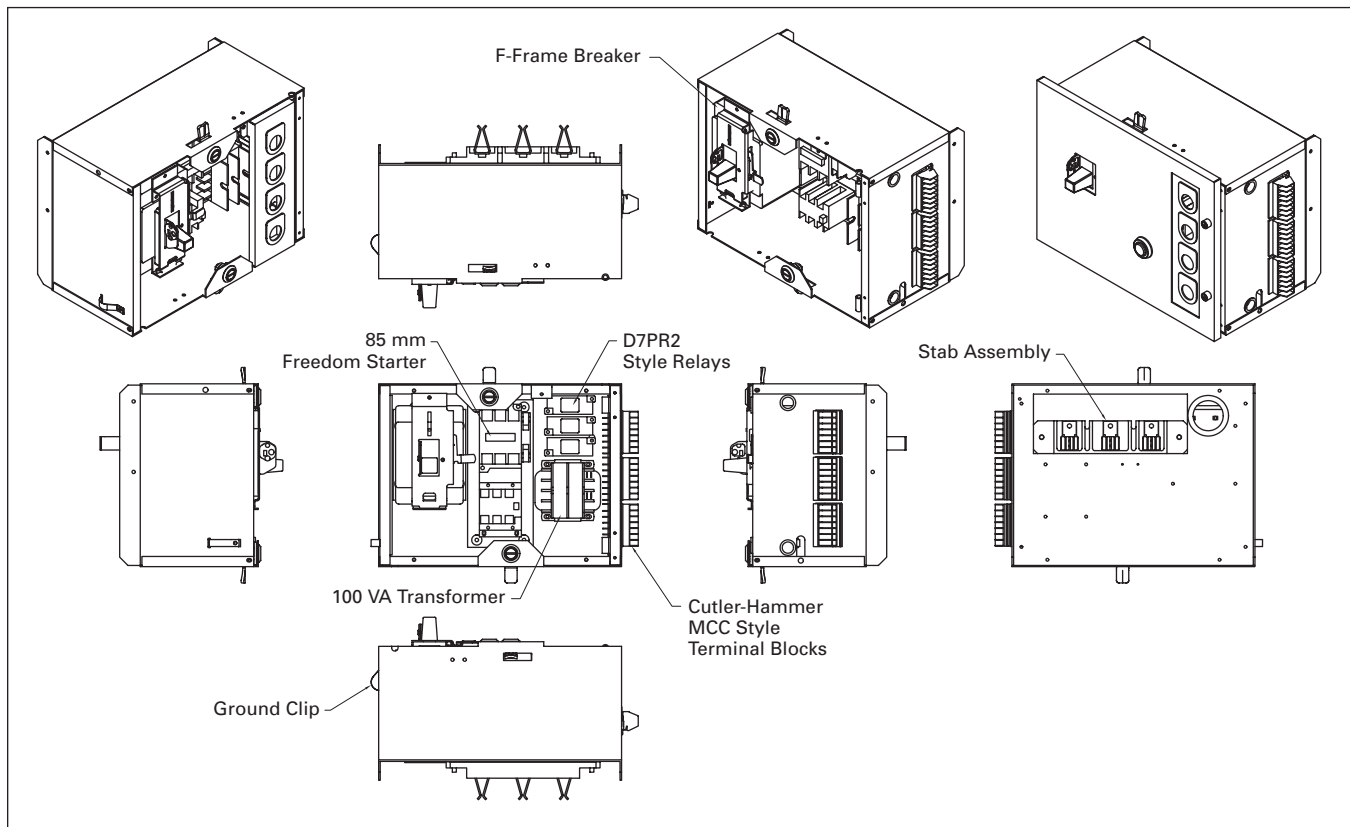

Figure 1. 5600 Series Design Concept

## 5600 Series Replacement Starter Units

### How to Order

When ordering a replacement unit, you receive:

- Series C® HMCP.
- Freedom Starter.  
(See option codes for additional starter types offered.)
- Unit options as specified.
- New steel wrapper, door and handle mechanism.
- New stabs.
- UL 845 label.

### Use the following steps for creating a catalog number for your specific application:

#### Step 1

Select the correct replacement unit from **Page 5 – 9**. When selecting, you need to know the following:

- MCC type.
- Class of Unit (FVNR; FVR; Solid-State Reduced Voltage Soft Start; 2-Speed, 1 Winding; or 2-Speed, 2 Winding).
- Starter size or horsepower rating.
- Protection device (breaker or fusible).

- Service voltage.
- Control voltage.
- Space required.

#### Step 2

Verify required space is available.

#### Step 3

Create a catalog number by selecting Catalog Codes from the columns per the example given.

#### Step 4

Add modifications as required from the Unit Options on **Pages 10 – 12**. Space available determines allowable options.

**Table 2. Catalog Numbering System Example**

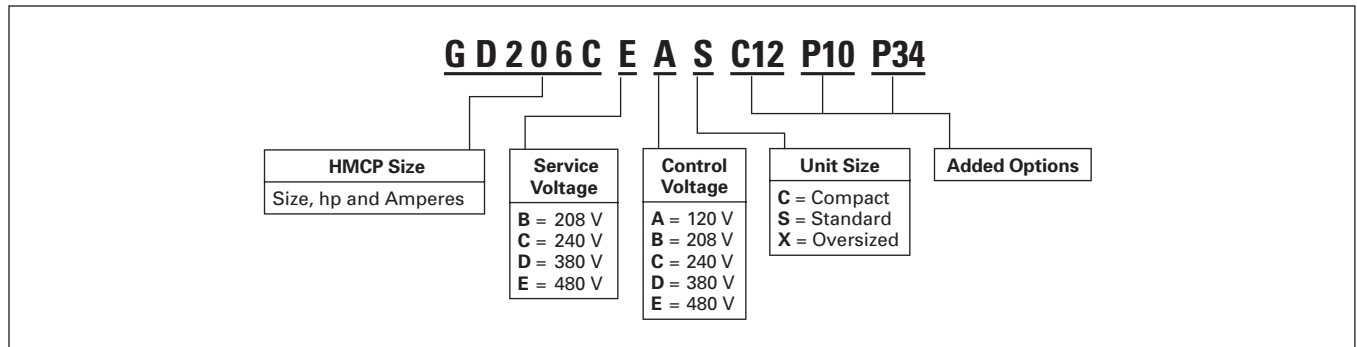

**Table 3. Full Voltage Non-Reversing Combination Starter — HMCP**

NEMA Size	Maximum Horsepower				HMCP Size	Catalog Code	Service Voltage	Catalog Code	Control Voltage	Catalog Code	Space Options Inches (mm)	Catalog Code
	208 V	240 V	380 V	480 V								
1	0.5	0.33	1	1	3	<b>GD206A</b> <b>GD206B</b> <b>GD206C</b> <b>GD206D</b>	208	<b>B</b> <b>C</b> <b>D</b> <b>E</b>	120	<b>A</b> <b>B</b> <b>C</b> <b>D</b> <b>E</b>	12 (304.8) High 18 (457.2) High	<b>S</b> <b>X</b>
	1	1	2	3	7		240		208			
	3	3	5	7.5	15		380		240			
	7.5	7.5	10	10	30		480		380			
							480		480			
2	10	15	25	25	50	<b>GD206E</b>	208	<b>B</b> <b>C</b> <b>D</b> <b>E</b>	120	<b>A</b> <b>B</b> <b>C</b> <b>D</b> <b>E</b>	12 (304.8) High 18 (457.2) High	<b>S</b> <b>X</b>
							240		208			
							380		240			
							480		380			
									480			
3	25	30	50	50	100	<b>GD206H</b>	208	<b>B</b> <b>C</b> <b>D</b> <b>E</b>	120	<b>A</b> <b>B</b> <b>C</b> <b>D</b> <b>E</b>	18 (457.2) High 24 (609.6) High	<b>C</b> <b>S</b>
							240		208			
							380		240			
							480		380			
									480			
4	40	50	75	100	150	<b>GD206L</b>	208	<b>B</b> <b>C</b> <b>D</b> <b>E</b>	120	<b>A</b> <b>B</b> <b>C</b> <b>D</b> <b>E</b>	18 (457.2) High 24 (609.6) High	<b>C</b> <b>S</b>
							240		208			
							380		240			
							480		380			
									480			
5	60	60	125	150	250	<b>GD206P</b> <b>GD206R</b>	208	<b>B</b> <b>C</b> <b>D</b> <b>E</b>	120	<b>A</b> <b>B</b> <b>C</b> <b>D</b> <b>E</b>	48 (1219.2) High	<b>S</b> ①②
							240		208			
	75	100	150	200	400		380		240			
							480		380			
							480		480			

① NEMA Size 5 available. Cable in/Cable out unit.

② Consult factory.

### 5600 Series Replacement Starter Units

Table 4. Full Voltage Reversing Combination Starter — HMCP

NEMA Size	Maximum Horsepower				HMCP Size	Catalog Code	Service Voltage	Catalog Code	Control Voltage	Catalog Code	Space Options Inches (mm)	Catalog Code
	208 V	240 V	380 V	480 V								
1	0.5 1 3 7.5	0.33 1 3 7.5	1 2 5 10	1 3 7.5 10	3 7 15 30	GD216A GD216B GD216C GD216D	208 240 380 480	B C D E	120 208 240 380 480	A B C D E	18 (457.2) High	S
2	10	15	25	25	50	GD216E	208 240 380 480	B C D E	120 208 240 380 480	A B C D E	24 (609.6) High	S
3	25	30	50	50	100	GD216H	208 240 380 480	B C D E	120 208 240 380 480	A B C D E	36 (914.4) High	S
4	40	50	75	100	150	GD216L	208 240 380 480	B C D E	120 208 240 380 480	A B C D E	36 (914.4) High	S

Table 5. Full Voltage 2-Speed 1 Winding — Constant/Variable Torque — HMCP ①

NEMA Size	Maximum Horsepower				HMCP Size	Catalog Code	Service Voltage	Catalog Code	Control Voltage	Catalog Code	Space Options Inches (mm)	Catalog Code
	208 V	240 V	380 V	480 V								
1	0.5 1 3 7.5	0.33 1 3 7.5	1 2 5 10	1 3 7.5 10	3 7 15 30	GD946A GD946B GD946C GD946D	208 240 380 480	B C D E	120 208 240 380 480	A B C D E	24 (609.6) High	S
2	10	15	25	25	50	GD946E	208 240 380 480	B C D E	120 208 240 380 480	A B C D E	30 (762.0) High	S
3	25	30	50	50	100	GD946H	208 240 380 480	B C D E	120 208 240 380 480	A B C D E	36 (914.4) High	S
4	40	50	75	100	150	GD946L	208 240 380 480	B C D E	120 208 240 380 480	A B C D E	42 (1066.8) High	S

① For constant horsepower instead of constant/variable torque, see Option SV6 on Page 12.

Table 6. Full Voltage 2-Speed 2 Winding — Constant/Variable Torque — HMCP ②

NEMA Size	Maximum Horsepower				HMCP Size	Catalog Code	Service Voltage	Catalog Code	Control Voltage	Catalog Code	Space Options Inches (mm)	Catalog Code
	208 V	240 V	380 V	480 V								
1	0.5 1 3 7.5	0.33 1 3 7.5	1 2 5 10	1 3 7.5 10	3 7 15 30	GD956A GD956B GD956C GD956D	208 240 380 480	B C D E	120 208 240 380 480	A B C D E	18 (457.2) High	S
2	10	15	25	25	50	GD956E	208 240 380 480	B C D E	120 208 240 380 480	A B C D E	24 (609.6) High	S
3	25	30	50	50	100	GD956H	208 240 380 480	B C D E	120 208 240 380 480	A B C D E	36 (914.4) High	S
4	40	50	75	100	150	GD956L	208 240 380 480	B C D E	120 208 240 380 480	A B C D E	36 (914.4) High	S

② For constant horsepower instead of constant/variable torque, see Option SV6 on Page 12.

## 5600 Series Replacement Starter Units

### IT06 — Intelligent Technologies *IT*. Solid-State Reduced Voltage Start — HMCP

The *IT*. solid-state reduced voltage starter uses SCRs when starting and a low impedance run circuit during operation. Solid-state starters have five (5) 24 Vdc inputs and two (2) relay outputs. Soft start units include a disconnect, starter, 24 Vdc power supply and 100 VA CPT.

#### Motor Service Factor (SF) Effect on *IT*. Starter Selection

- A 1.0 service factor motor may draw up to 1.00 x full load amperes.
- A 1.15 service factor motor may draw up to 1.15 x full load amperes.
- 15% more current. *IT*. starters are current rated devices. In some cases, a larger *IT*. SSRV starter must be supplied for 1.15 SF motors. See the maximum horsepower chart below.

**Note:** Most motors used in industrial applications are 1.15 service factor (SF).

**Table 7. Replacement *IT*. Soft Start Units**

Service Factor	Horsepower	<i>IT</i> . Soft-Start Amperes	HMCP Amperes	Catalog Code	Service Voltage	Catalog Code	Control Voltage	Catalog Code	Space Options Inches (mm)	Catalog Code
1.15	20	37	150	GD306A	480	E	120	A	18 (457.2) High	S
	40	66		GD306B			208	B		
	60	105	250	GD306C			240	C	30 (762.0) High	
	75	135	GD306D	380			D			
	125	180	400 ①	GD306E			480	E	48 (1219.2) High	
	150	240	GD306F	—			—			
	200	304	GD306G	—			—			

① No stab — unit cable in/cable out.

**Table 8. Full Voltage Non-Reversing — Fusible ②**

NEMA Size	Maximum Horsepower					Fuse Clip Amperes	Catalog Code	Service Voltage	Catalog Code	Control Voltage	Catalog Code	Space Options Inches (mm)	Catalog Code
	208 V	240 V	380 V	480 V	600 V								
1	7.5	7.5	10	10	10	30		208 240 380 480	B C D E	120 208 240 380 480	A B C D E		S
2	— 10	— 15	15 25	15 25	25 —	30 60		208 240 380 480	B C D E	120 208 240 380 480	A B C D E		S
3	— 25	20 30	30 50	40 50	50 —	60 100		208 240 380 480	B C D E	120 208 240 380 480	A B C D E		S
4	— 50	— 50	— 60	60 100	75 100	100 200		208 240 380 480	B C D E	120 208 240 380 480	A B C D E		S

② Fuse clip ratings shown are based on Class RK1, 5 fuses.

### 5600 Series Replacement Starter Units

Table 9. Full Voltage Reversing — Fusible ①

NEMA Size	Maximum Horsepower					Fuse Clip Amperes	Catalog Code	Service Voltage	Catalog Code	Control Voltage	Catalog Code	Space Options Inches (mm)	Catalog Code
	208 V	240 V	380 V	480 V	600 V								
1	7.5	7.5	10	10	10	30		208 240 380 480	B C D E	120 208 240 380 480	A B C D E		S
2	— 10	— 15	15 25	15 25	25 —	30 60		208 240 380 480	B C D E	120 208 240 380 480	A B C D E		S
3	— 25	20 30	30 50	40 50	50 —	60 100		208 240 380 480	B C D E	120 208 240 380 480	A B C D E		S
4	— 50	— 50	— 60	60 100	75 100	100 200		208 240 380 480	B C D E	120 208 240 380 480	A B C D E		S

① Consult factory for details.

Table 10. Full Voltage 2-Speed 1 Winding — Fusible — Constant/Variable Torque ②

NEMA Size	Maximum Horsepower					Fuse Clip Amperes	Catalog Code	Service Voltage	Catalog Code	Control Voltage	Catalog Code	Space Options Inches (mm)	Catalog Code
	208 V	240 V	380 V	480 V	600 V								
1	7.5	7.5	10	10	10	30		208 240 380 480	B C D E	120 208 240 380 480	A B C D E		S
2	— 10	— 15	15 25	15 25	25 —	30 60		208 240 380 480	B C D E	120 208 240 380 480	A B C D E		S
3	— 25	20 30	30 50	40 50	50 —	60 100		208 240 380 480	B C D E	120 208 240 380 480	A B C D E		S
4	— 50	— 50	— 60	60 100	75 100	100 200		208 240 380 480	B C D E	120 208 240 380 480	A B C D E		S

② Consult factory for details.

## 5600 Series Replacement Starter Units

**Table 11. Full Voltage 2-Speed 2 Winding — Fusible — Constant/Variable Torque** ①

NEMA Size	Maximum Horsepower					Fuse Clip Amperes	Catalog Code	Service Voltage	Catalog Code	Control Voltage	Catalog Code	Space Options Inches (mm)	Catalog Code
	208 V	240 V	380 V	480 V	600 V								
1	7.5	7.5	10	10	10	30		208 240 380 480	<b>B</b> <b>C</b> <b>D</b> <b>E</b>	120 208 240 380 480	<b>A</b> <b>B</b> <b>C</b> <b>D</b> <b>E</b>		<b>S</b>
2	— 15	— 15	15 25	15 25	25 —	30 60		208 240 380 480	<b>B</b> <b>C</b> <b>D</b> <b>E</b>	120 208 240 380 480	<b>A</b> <b>B</b> <b>C</b> <b>D</b> <b>E</b>		<b>S</b>
3	— 25	20 30	30 50	40 50	50 —	60 100		208 240 380 480	<b>B</b> <b>C</b> <b>D</b> <b>E</b>	120 208 240 380 480	<b>A</b> <b>B</b> <b>C</b> <b>D</b> <b>E</b>		<b>S</b>
4	— 50	— 50	— 60	60 100	75 100	100 200		208 240 380 480	<b>B</b> <b>C</b> <b>D</b> <b>E</b>	120 208 240 380 480	<b>A</b> <b>B</b> <b>C</b> <b>D</b> <b>E</b>		<b>S</b>

① Consult factory for details.



## 5600 Series Unit Options

Table 12. Option Groups ①

Groups	Description	Page Number
B	Circuit Breaker Options	10
C	Control Power Source Options	10
G	Ground Fault Protection Options	10
K	Starter Type Options	10
M	Metering Options	11
O	Overload Options	11
P	Pilot Device Options	11
R	Relay and Timer (Control, Voltage, Current) Options	12
S	Starter Contact Options	12
SV	Vacuum Starter Options	12
T	Terminal Block Options	12
U	Unit Wiring Options	12

① Select your option suffix and attach it to the end of the catalog number.

Table 13. Option Suffix

Suffix	Description	Space Required ②
--------	-------------	------------------

**B — Breaker Options**

B10	Shunt Trip 120 Vac Wired to Terminal Blocks for Remote Tripping	C
B11	Auxiliary Switch Form C (1NO/1NC) Wired to Terminal Blocks	C
B12	Form C Bell Alarm Contact (1NO/1NC) Wired to Terminal Blocks	C
B13	Undervoltage Release	C
B14	IQ Energy Sentinel — F Frame	③
B15	IQ Energy Sentinel — J Frame	③
B16	IQ Energy Sentinel — K Frame	③
B17	IQ Central Energy Display	③
B18	Thermal Magnetic Circuit Breaker Instead of HMCP	—

**C — Control Power Source Options**

C10	Control Fuse Wired for Separate Source in Lieu of Control Power Transformer	C
C11	Control Fuse with Disconnect for Separate Source in Lieu of Control Power Transformer	C
C12	Control Power Transformer 100 VA for Sizes 1 and 2 Starters (Fused)	C ④
C13	Control Power Transformer 150 VA for Sizes 3 and 4 Starters (Fused)	C
C14	Control Power Transformer 100 VA with Interposing Relay for Size 5 Starters, Fused	C
C15	Extra 50 VA for Control Power Transformer	S
C16	Extra 100 VA for Control Power Transformer	S
C17	Service Voltage Control, Fused in Lieu of Control Power Transformer	C
C18	Full Capacity Control Power Transformer for Size 5 Starters, Fused	C

**G — Ground Fault Protection Options**

G10	Class 1 Ground Fault Protection — GRT1 Sizes 1 – 4	X
G11	Class 1 Ground Protection — GRT1 Sizes 5 – 6	X
G12	Ground Fault Test Panel	X

**H — IT-EM Options**

H10	DSNAP Communication Module	S
-----	----------------------------	---

**K — Starter Type Options**

K10	IT-EM Size 1 with Relays and Power Supply Included	S
K11	IT-EM Size 2 with Relays and Power Supply Included	S
K12	IT-EM Size 3 with Relays and Power Supply Included	S
K13	IT-EM Size 4 with Relays and Power Supply Included	S
K15	A200 Size 1	S
K16	A200 Size 2	S
K17	A200 Size 3	S
K18	A200 Size 4	S
K19	A200 Size 5	S

② Minimum unit size required (refer to Replacement Unit pages).

③ Consult factory for spacing.

④ Not available in 6 inches (152.4 mm).

**5600 Series Unit Options**

**Table 13. Option Suffix (Continued)**

Suffix	Description	Space Required <sup>①</sup>
<b>M — Metering Options</b>		
M10	Mini Voltmeter	C <sup>②</sup>
M11	Mini Ammeter with Current Transformer	S
M12	Mini Elapsed Time Meter	C <sup>②</sup>
M13	Current Transformer for Remote Metering	S
M14	Current Transducer 4-20 mA Output	X
<b>O — Overload Options</b>		
O10	IQ 500 Solid-State Overload Relay	—
O11	IQ 500 Load Protection Module	—
O16	Bell Alarm (1NO) Wired	C
O17	Bi-Metallic Overload Substitution	C
O18	Adjustable A200 Overload Substitution	C
O19	Overload Relay Heater/Heater Pack	C
O20	CEP7 Solid-State Overload Relay	C
<b>P — Pilot Device Options <sup>③</sup></b>		
P10	Red "RUN" Light	C
P11	Green "STOPPED" Light	C
P12	Amber "OVERLOAD TRIPPED" Light	C
P13	Green "RUN" Light	C
P14	Red "STOPPED" Light	C
P15	Red "RUN" Push-to-Test Light	C
P16	Green "STOPPED" Push-to-Test Light	C
P17	Amber "OVERLOAD TRIPPED" Push-to-Test Light	C
P18	Green "RUN" Push-to-Test Light	C
P19	Red "STOPPED" Push-to-Test Light	C
P20	Special Function Light	C
P30	"START" Pushbutton	C
P31	"STOP" Pushbutton	C
P32	"START/STOP" Pushbutton	C
P33	"ON" Pushbutton	C
P34	"OFF" Pushbutton	C
P35	"ON/OFF" Pushbutton	C
P36	"FORWARD/REVERSE/STOP" Pushbutton	C
P37	"FAST/SLOW/STOP" Pushbutton	C
P38	"FAST/OFF/SLOW" Pushbutton	C
P39	"HIGH/LOW/STOP" Pushbutton	C
P40	"HIGH/LOW/OFF" Pushbutton	C
P41	Special Function Pushbutton	C
P50	"ON-OFF" Selector Switch	C
P51	"HIGH-LOW" Selector Switch	C
P52	"OFF-AUTO" Selector Switch	C
P53	"START-STOP" Selector Switch	C
P54	"SLOW-FAST" Selector Switch	C
P55	"FORWARD-REVERSE" Selector Switch	C
P56	Special Function 2-Position Selector Switch	C
P57	"HAND-OFF-AUTO" Selector Switch	C
P58	"LOCAL-OFF-REMOTE" Selector Switch	C
P59	"FAST-OFF-SLOW" Selector Switch	C
P60	"HIGH-OFF-LOW" Selector Switch	C
P61	Special Function 3-Position Selector Switch	C
P62	"HIGH-LOW-OFF-AUTO" Selector Switch	C
P63	Special Function 4-Position Selector Switch	C

<sup>①</sup> Minimum unit size required (refer to Replacement Unit pages).

<sup>②</sup> Customer to supply range of meter required.

<sup>③</sup> Available only with F2100, Advantage, Series 2100/5 Star, Freedom Unitrol, F10 Unitrol and Type W. Consult factory for specific size limitations.

## 5600 Series Unit Options

Table 13. Option Suffix (Continued)

Suffix	Description	Space Required <sup>①</sup>						
<b>R — Relay and Timer Options</b>								
R10	Auxiliary Control Relay 2-Pole (1NO/1NC) Convertible Contacts Wired in Parallel with Starter Coil	S						
R11	Auxiliary Control Relay 4-Pole (2NO/2NC) Convertible Contacts Wired in Parallel with Starter Coil	S						
R12	Auxiliary Control Relay 2-Pole Overload Alarm (1NO/1NC) Convertible Contacts	S						
R13	Mechanical Latching Relay (Specify Connection)	X						
R14	Ice Cube Relay 300 Volts 3-Pole Blade Type (Specify Connection)	S						
R15	Phase Voltage Relay	X						
R16	Current Sensing Relay with Contacts Wired to Terminal Blocks	X						
R17	Deceleration Timing Relay (Pneumatic "OFF" Delay)	S						
R18	Compelling Timing Relay (Pneumatic "ON" Delay)	S						
R19	Time Clock 24 Hour	②						
R20	Time Clock 7 Day	②						
R21	Solid-State Timer Type TR (Specify Connection)	S						
R22	DN65 DeviceNet™ Interface Module	S						
R23	D15 2-Pole Control Relay	C						
R24	D15 4-Pole Control Relay	C						
<b>S — Starter Contact Options (Maximum of 8 Contacts)</b>								
S__	To order extra starter contacts, you must specify the number of NO/NC contacts, given a maximum of eight (8). To define the unit option required, create a suffix based on the following example:							
	<table border="1"> <thead> <tr> <th></th> <th>Quantity of Normally Open Contacts</th> <th>Quantity of Normally Closed Contacts</th> </tr> </thead> <tbody> <tr> <td>S</td> <td>2</td> <td>3</td> </tr> </tbody> </table>		Quantity of Normally Open Contacts	Quantity of Normally Closed Contacts	S	2	3	
	Quantity of Normally Open Contacts	Quantity of Normally Closed Contacts						
S	2	3						
<b>SV — Vacuum Starter Options</b>								
SV4	Vacuum Starter Size 4 Substitution FVNR	②						
SV5	Vacuum Starter Size 5 Substitution FVNR	②						
SV6	Constant Horsepower Instead of Constant/Variable Torque	—						
<b>T — Terminal Block Options</b>								
T10	Pull-apart Type Terminal Blocks (Standard on all Vintages Except Type W and 11-300)	S						
T11	Utility Screw Type Terminal Blocks (Add 6 Inches [152.4 mm] for Every 18 Points)	—						
T12	Front-mounted Pull-apart Terminal Block for F2100, Advantage, Series 2100/5 Star	S						
T13	T-Lead Power Terminal Blocks for Size 1 Starter	—						
<b>U — Unit Wiring Options</b>								
U10	Surge Suppressor on Coil	C						
U11	Type SIS Control Wire	C						
U12	Type SIS Power Wire	C						
U13	Type 14 Gauge Control Wire (Standard for all Vintages Except F2100, Series 2100/5 Star, Type W and 11-300)	C						
U14	Wiremarkers — Sleeve Type on all Control Wire	C						
U15	Locking Fork Terminals on all Control Wiring	S						
U16	Ring Wire Terminals on Power Wiring	S						
U17	Wiring Diagram Inside Starter Unit Door	C						
U18	Pre-insulated Ring Terminals on all Control Wiring	C						
U19	Pre-insulated Ring Terminals on all Control Wiring, except for Freedom Starter Terminals	C						
U20	Wiremarkers for Power Wiring	C						

① Minimum unit size required (refer to Replacement Unit pages).

② Consult factory for spacing.

**How to Create a Catalog Number**

After selecting the circuit device required, create a Dual-Mounted feeder unit catalog number based on the following.

**Note:** Catalog number varies in length based on single- or dual-mounted unit.

**Table 14. Catalog Numbering System Example**

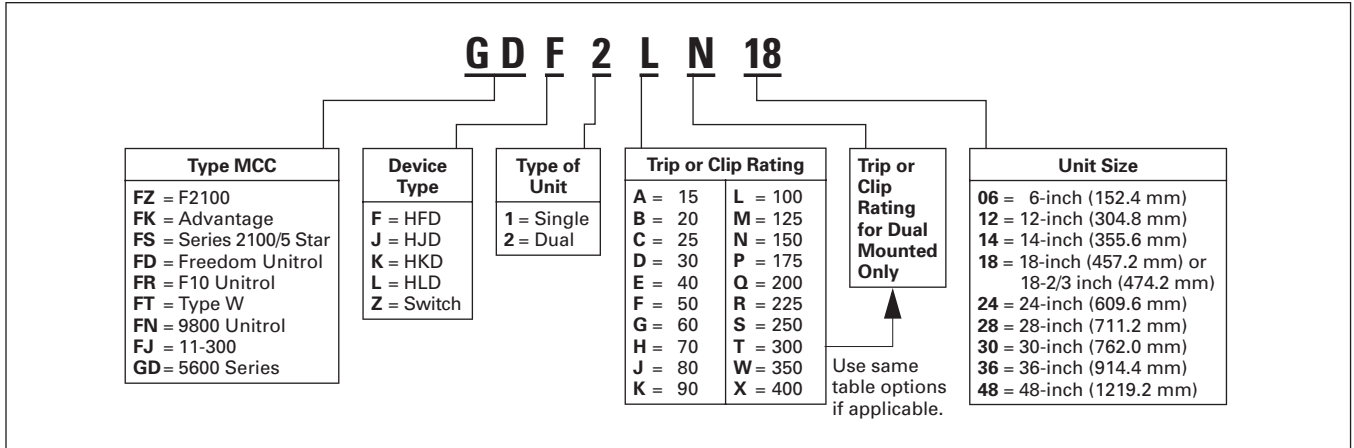

**Replacement Feeder Units**

**Product Description**

Each Feeder Unit consists of a single-mounted 3-pole molded case circuit breaker (dual-mounted are also available). Each unit includes a new wrapper, stab assembly, door and handle mechanism. They are shipped assembled and ready to install into the existing motor control center.

The following are simple steps to select and order a new feeder unit:

**Step 1**

Select the circuit device required from **Table 15**.

**Step 2**

Verify the amount of space available.

**Step 3**

Create a catalog number using **Table 14** on **Page 13**.

**Unit options and modifications for replacement feeder units:**

For factory installed molded case circuit breaker modifications or additional unit options, see **Pages 10 – 12**, or contact the factory for additional prices and availability.

**Table 15. Electrical Characteristics and Space Requirements of Molded Case Circuit Breakers and Fusible Switch Replacement Feeder Units — Inches (mm)**

Device Type	Maximum Amperes	Interrupting Rating (kAIC)			Trip Rating or Clip	ITE 5600	
		240 V	480 V	600 V		Single	Dual ①
HFD	150	100	65	25	15	12 ② (304.8)	12 ①② (304.8)
					20		
					25		
					30		
					40		
					50		
					60		
					70		
					80		
					90		
HJD	250	100	65	25	175	18 (457.2)	—
					200		
					225		
					250		
					250		
HKD	400	100	65	35	300	24 ③ (609.6)	—
					350		
					400		
Fusible Switch	30	100	100	100	30	④	—
	60						
	100						
	200						
	400						

① Combined ampacity no greater than 150 amperes for 12-inch (304.8 mm) height. For greater than 150 amperes, 18-inch (457.2 mm) required.  
 ② Available in 18-inch (457.2 mm) height.  
 ③ Cable in/cable out, no stab assembly.  
 ④ Consult factory.

5600 Series Unit Parts

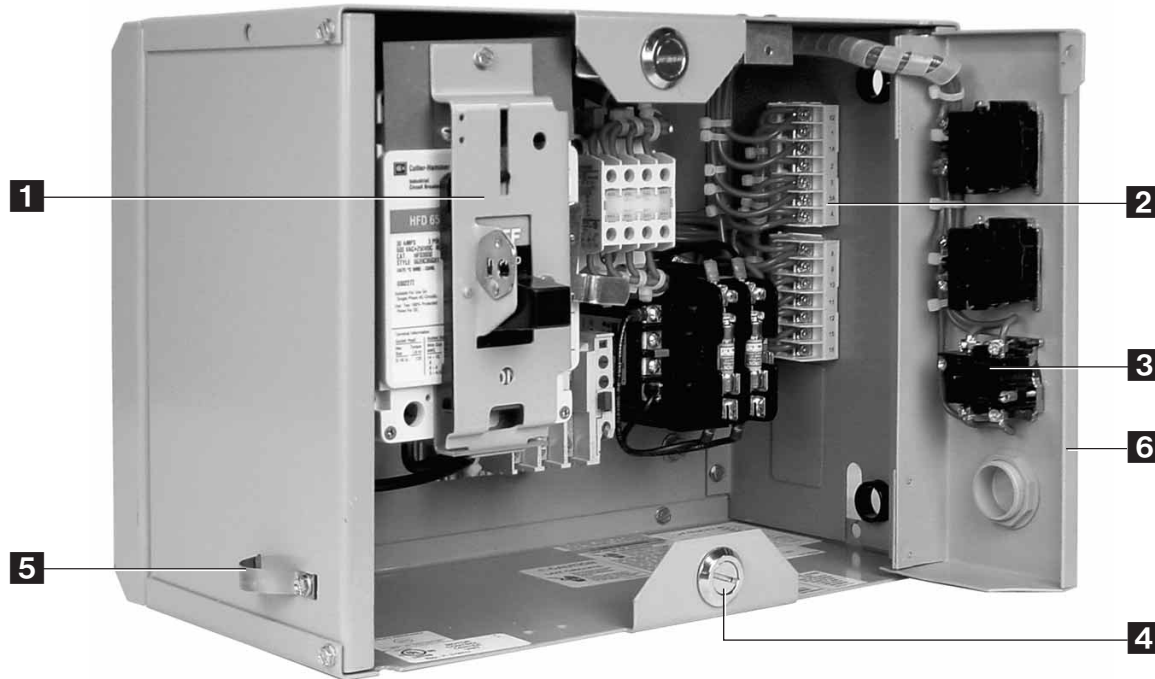

Table 16. Unit Parts

Reference	Description	Page
1	Operating Handle Mechanism Overload Reset Button and Reset Rod Ext. Kit	14
2	Terminal Blocks	15
3	Overload Reset and Rod or Electronic Overload Switch	14

Reference	Description	Page
4	Unit Interlock	
5	Ground Clip	
6	Device Panel	15

Operating Handle Mechanism Kit 1



Table 17. Operating Handle Mechanism Kit

Circuit Breaker Unit Description	Style Number
HMCP, FS or FB (150 A Frame)	10-7175-5
JD (250 A Frame)	10-7176-2
KB, KD or KS (400 A Frame)	10-7176-3

Slider Type for Circuit Breaker

Note: Kit includes handle mechanism with mounting hardware.

Overload Reset Kits 3

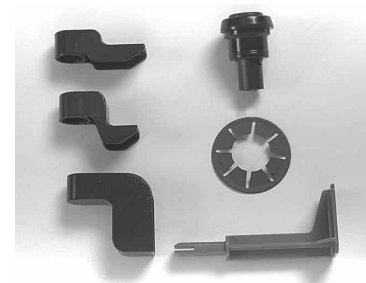

Overload Reset Button and Reset Rod  
Extension Kit

Table 18. Overload Reset Button and Reset  
Rod Extension Kit

Description	Style Number
For Freedom starters, the kit includes reset button, retainer and adapter.	4719A92G58
Electronic overload reset for IT-EM starters	Consult Factory

**5600 Series Unit Parts**

**Door Latch Kit**



*Door Latch Kit*

**Table 19. Door Latch Kit**

Description	Style Number
Kit includes two (2) 1/4 turn latches.	Consult Factory

**Blank Unit Door Kit**

**Table 20. Blank Unit Door Kit**

Dimensions in Inches (mm)		Style Number
Height	Width	
<b>Standard Width</b>		
6 (152.4)	14-3/4 (374.7)	Consult Factory
12 (304.8)	14-3/4 (374.7)	
18 (457.2)	14-3/4 (374.7)	
24 (609.6)	14-3/4 (374.7)	

**Divider Pan/Guide Rails with Mounting Hardware**

**Table 21. Divider Pan/Guide Rails with Mounting Hardware**

Description	Style Number
Divider pan/guide rails with mounting hardware.	Consult Factory

**Device Panel with Mounting Hardware**

**Table 22. Device Panel with Mounting Hardware**

Description	Style Number
Device panel/pivot tube with mounting hardware.	Consult Factory

**Unit Support Bracket**

**Table 23. Unit Support Bracket**

Description	Style Number
Left-hand side	Consult Factory
Right-hand with wireway	
Right-hand without wireway	

**Primary/Secondary Fuse Holder Kit**

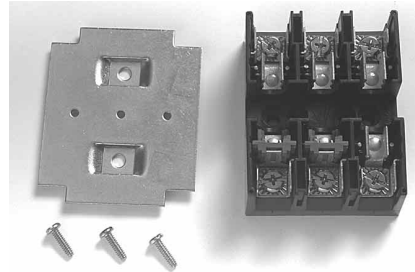

*Primary/Secondary Fuse Holder Kit*

**Table 24. Primary/Secondary Fuse Holder Kit**

Description	Style Number
Kit includes fuse block, mounting bracket and screws.	4719A92G59

**Control Transformers (480/240 V to 120 V Single-Phase)**

**Table 25. Control Transformers (480/240 V to 120 V Single-Phase)**

Description	Style Number
50 VA	4719A92G46
100 VA	4719A92G48
150 VA	4719A92G49
200 VA	4719A92G50
250 VA	4719A92G51
300 VA	4719A92G52
350 VA	4719A92G53
500 VA	4719A92G54

**Terminal Blocks**

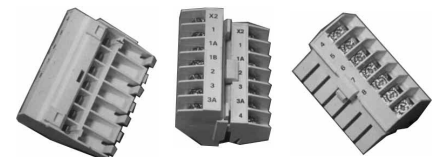

*Terminal Blocks*

**Table 26. Terminal Blocks**

Description	Style Number
White, 7 circuit, pull-apart	4719A92G57

NEMA is the registered trademark and service mark of the National Electrical Manufacturers Association. UL is a registered trademark of Underwriters Laboratories Inc. ITE is a federally registered trademark of Integrated Technologies Engineering (ITE). Gould is a federally registered trademark of Gould Electronics Inc. Telemecanique is a federally registered trademark of Schneider Electric SA. Siemens is a federally registered trademark of Siemens AG.

Eaton Corporation  
Cutler-Hammer business unit  
1000 Cherrington Parkway  
Moon Township, PA 15108-4312  
USA  
tel: 1-800-525-2000  
[www.cutler-hammer.eaton.com](http://www.cutler-hammer.eaton.com)