



Cutler-Hammer

Motor Control Center Type Advantage™

Renewal Parts

Supersedes RP.03A.02.S.E
pages 1-24, dated September 2000

Description

Page

Motor Control Center Type Advantage

Distributor Ordering Instructions	2
Procedure for Identifying MCC Renewal Units and Parts	2
Identifying Motor Control Center Types	3
Identification by Original Handle Mechanism	3
Procedure for Identifying Motor Control Center Types	4
Advantage Product Description	5
Replacement Starter Units	6 – 15
Unit Options	16 – 18
Structure Parts	19 – 22
Unit Parts	23 – 24
Replacement Feeder Units (All Vintages)	26

MCC Type	Dates	Cutler-Hammer Renewal Parts Publication
F2100 Advantage Series 2100	1995 – 1992 – 1987 – 95	RP04304001E RP04304002E RP04304003E
5 Star Freedom Unitrol F10 Unitrol	1975 – 87 1988 – 94 1972 – 89	RP04304003E RP04304004E RP04304005E
Type W 9800 Unitrol 11-300	1965 – 75 1956 – 74 1935 – 65	RP04304006E RP04304007E RP04304008E

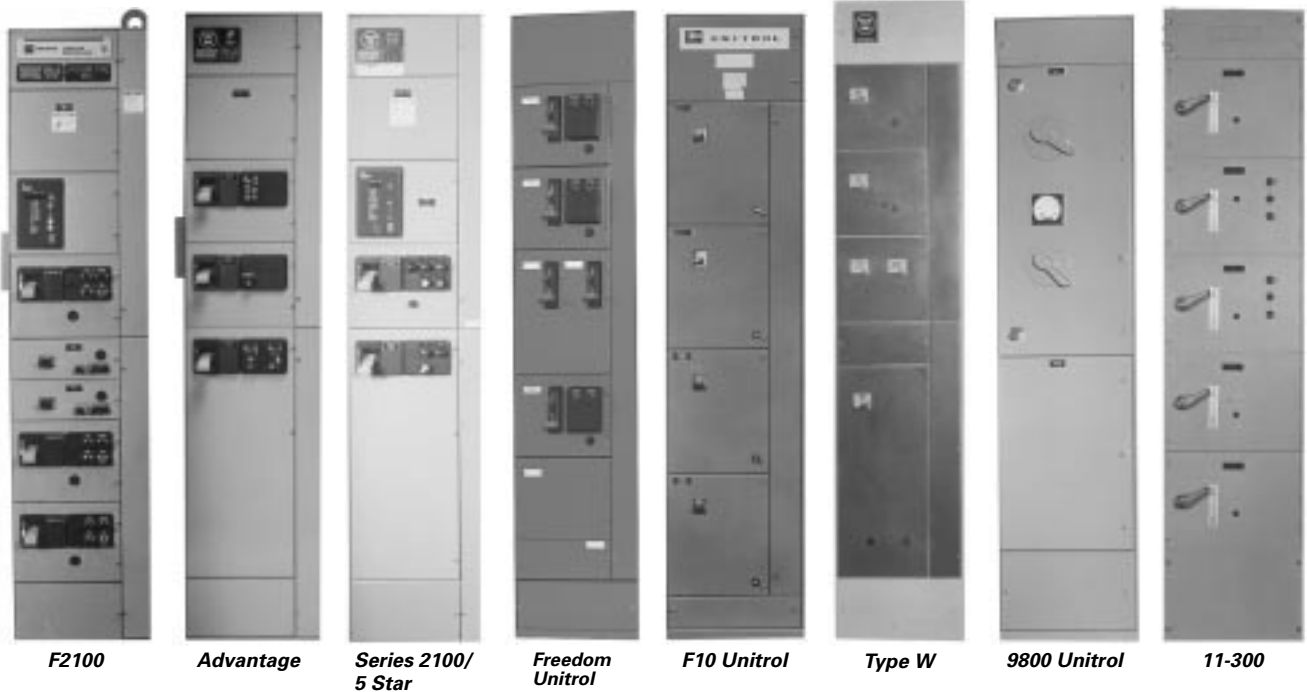

F2100

Advantage

Series 2100/
5 Star

Freedom
Unitrol

F10 Unitrol

Type W

9800 Unitrol

11-300

Identifying Motor Control Center Types

In most cases, it is possible to identify MCC design by handle type. Starter type, bucket width and door width can assist in identification.

Table 1. Identifying Motor Control Center Types

MCC Type	Type of Handle Mechanism	Original MCC Starter Type	Bucket Width Inches (mm)	Door Width Inches (mm)	Original Manufacturer ①	Starter Type (Installed in New Unit)
F2100 ②	Lever	Freedom Series	13-3/4 (349.3)	15-5/8 (397.0)	Cutler-Hammer 1994 to Present	Freedom
Advantage ②	Lever	Advantage	13-3/4 (349.3)	15-5/8 (397.0)	Westinghouse until 1994 Cutler-Hammer 1994 to Present	Advantage
Series 2100 ②	Lever	A200	13-3/4 (349.3)	15-5/8 (397.0)	Westinghouse until 1994 Cutler-Hammer 1994 to Present	A200
5 Star ②	Lever	A200	13-3/4 (349.3)	15-5/8 (397.0)	Westinghouse 1975 – 1987	A200
Freedom Unitrol	Slider	Freedom Series	13-7/8 (352.5)	15-1/2 (393.7)	Cutler-Hammer 1988 – 1994	Freedom
F10 Unitrol	Slider and Lever	Citation	14 (355.6)	14-3/4 (374.7) w/ Wireway 19-1/2 (495.3) w/o Wireway	Cutler-Hammer 1972 – 1989	Freedom
Type W	Slider	A200 or 11-200	11-3/4 (298.5)	13-3/8 (339.9)	Westinghouse 1965 – 1975	A200
9800 Unitrol	Rotary ③	3 Star/Citation	16-1/8 (409.7)	19-3/8 (492.3)	Cutler-Hammer 1956 – 1974	Freedom
11-300	Rotary	11-200 Lifeline Type N/A200	15-3/4 (400.1)	20 (508.0)	Westinghouse 1950 – 1965	A200

① MCC types were sometimes produced outside the time spans shown. This was due to the overlap of production when a new design was adopted.

② The unit “wrappers” are mechanically identical for these designs.

③ 9800 originally was supplied with Rotary. New replacement units are manufactured with slider handle mechanism.

Identification by Original Handle Mechanism



*F2100, Advantage,
Series 2100/5 Star*



Freedom Unitrol

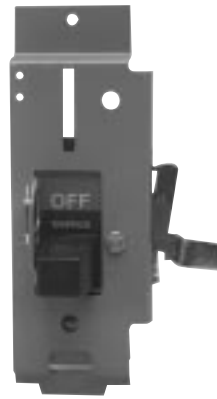

*F10 Unitrol Slider
9800 Unitrol*



*F10 Unitrol Lever
and 9800 Unitrol*



Type W



9800 Unitrol

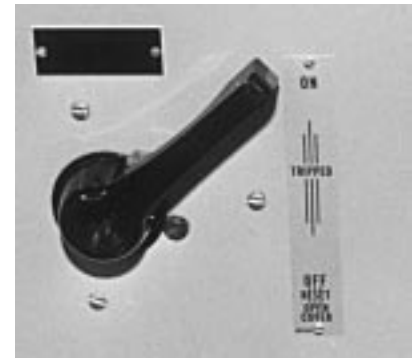

11-300

Procedure for Identifying Motor Control Center Types

In the event that the nameplate is missing, it is possible to identify the MCC design by the type of handle mechanism, starter type, bucket width and door width.

Table 2. Identifying Motor Control Center Types

MCC Type	Type of Handle Mechanism	Starter Type	Bucket Width Inches (mm)	Door Width Inches (mm)	Cutler-Hammer Renewal Parts Publication
F2100 Advantage Series 2100	Lever Lever Lever	Freedom Series Advantage A200	13-3/4 (349.3) 13-3/4 (349.3) 13-3/4 (349.3)	15-5/8 (397.0) 15-5/8 (397.0) 15-5/8 (397.0)	RP04304001E RP04304002E RP04304003E
5 Star Freedom Unitrol F10 Unitrol	Lever Slider Lever/Slider	A200 Freedom Series Citation	13-3/4 (349.3) 13-7/8 (352.5) 14 (355.6)	15-5/8 (397.0) 15-1/2 (393.7) 14-3/4 (374.7) w/ Wireway or 19-1/2 (495.3) w/o Wireway	RP04304003E RP04304004E RP04304005E
Type W 9800 Unitrol 11-300	Slider Rotary Rotary	A200 or 11-200 3 Star and/or Citation 11-200 Life-line N and/or A200	11-3/4 (298.5) 16-1/8 (409.7) 15-3/4 (400.1)	13-3/8 (339.9) 19-3/8 (492.3) 20 (508.0)	RP04304006E RP04304007E RP04304008E



F2100

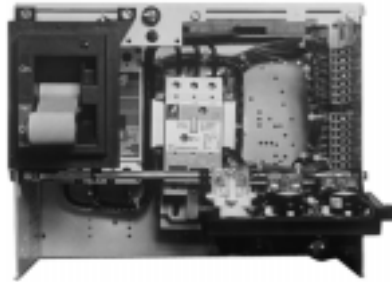

Advantage



Series 2100/5 Star

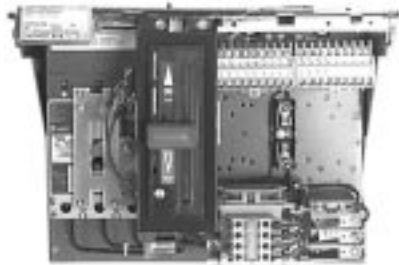

Freedom Unitrol

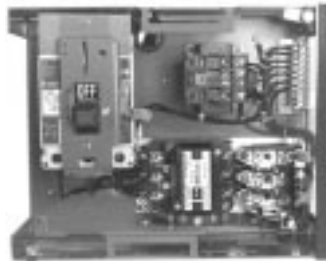

F10 Unitrol



Type W



9800 Unitrol



11-300

Advantage Product Description

Introduced in 1991 as a sister to the Westinghouse Series 2100 MCC, the Advantage starter design revolutionized the industry. It uses state-of-the-art technology to solve motor control application problems, such as coil burnout and contact chatter/welding.

The vertical structures are normally 20 inches (508.0 mm) wide, 90 inches (2286.0 mm) high and 16 inches (406.4 mm) or 21 inches (533.4 mm) deep. Vertical sections may be bolted together forming a single lineup with continuous horizontal bus and open horizontal wireways. Unit height is measured in 6-inch (154.4 mm) increments, up to a maximum of 72 inches (1828.8 mm) of usable vertical space.

A two-tone light/dark enamel paint system is used for this design. Ferro white is applied to the structural framework and units. ANSI 61 gray is applied to all exterior back sheets, side sheets and doors. Starter units are 13-3/4 inches (349.3 mm) wide and are interchangeable with the 5 Star and Series 2100 design.

The Advantage starter unit's handle mechanism is a gray toggle type handle with a black exterior mounting panel and is used on the Series 2100/5 Star and F2100 designs. Bus and bus support systems are typically braced to withstand fault currents of 65,000A.

Table 3. Advantage Product Rating

Maximum Ratings
3-Phase, 600V, 600 hp, 3200A Bus



Advantage Structure

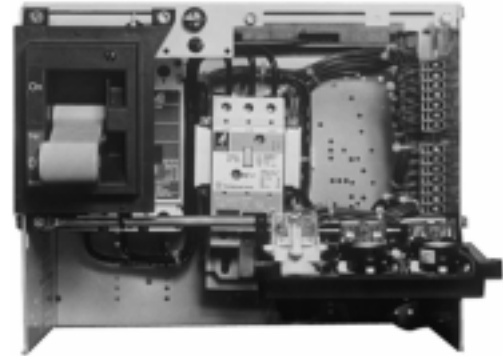

Advantage Starter Unit

Advantage Replacement Starter Units

How to Order

When ordering a replacement unit, you receive:

- Series C® HMCP or HMCPE.
- Advantage Starter.
- Unit options as specified.
- New steel wrapper, door and handle mechanism.
- New stabs.
- UL® label.

Use the following steps for creating a catalog number for your specific application:

Step 1

Select the correct replacement unit from **Pages 6 – 14**. When selecting, you need to know the following:

- MCC type.
- Class of Unit (FVNR, FVR, Reduced Voltage — Autotransformer or Part Winding or Solid State, FV – 2 Speed, 1 Winding or 2 Speed, 2 Winding, etc.).
- Starter size or horsepower rating.
- Protection device (breaker or fusible).
- Service voltage.
- Control voltage.
- Space required.

Step 2

Verify required space is available.

Step 3

Create a catalog number by selecting Catalog Codes from the columns per the example given.

Step 4

Add modifications as required from the Unit Options on **Pages 16 – 18**. Space available determines allowable options.

Table 4. Catalog Numbering System Example

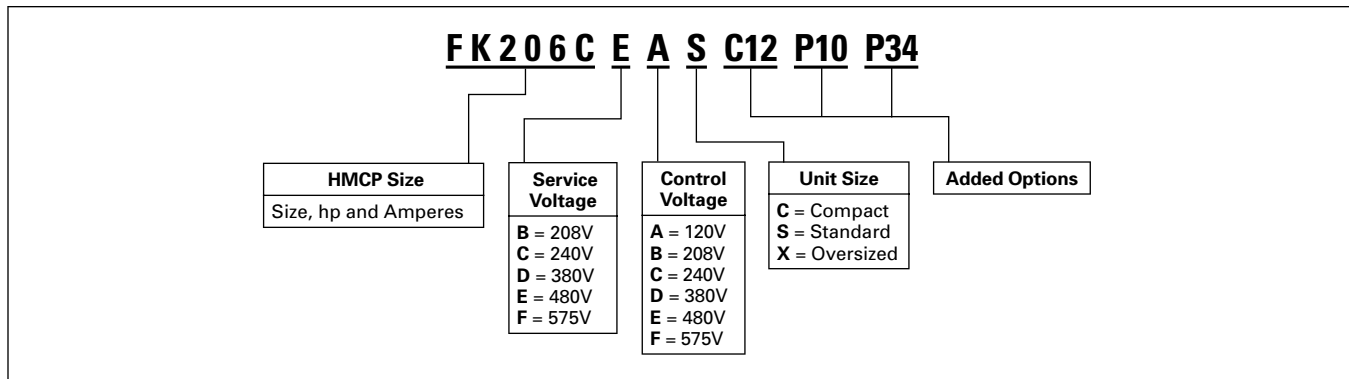

Table 5. Full Voltage Non-Reversing Combination Starter — HMCP (Must specify if HMCPE is required)

NEMA® Size	Maximum Horsepower					HMCP Size	Catalog Code	Service Voltage	Catalog Code	Control Voltage	Catalog Code	Space Options Inches (mm)	Catalog Code
	208V	240V	380V	480V	600V								
1	0.5	0.33	1	1	1.5	3	FK206A FK206B FK206C FK206D	208	B	120	A	6 (152.4) High 12 (304.8) High 18 (457.2) High	C ①
	1	1	2	3	3	7		240	C	208	B		S
	3	3	5	7.5	7.5	15		380	D	240	C		X
	7.5	7.5	10	10	10	30		480	E	380	D		
								575	F	480	E		
2	10	15	25	25	25	50	FK206E	208	B	120	A	12 (304.8) High 18 (457.2) High	S
								240	C	208	B		X
								380	D	240	C		
								480	E	380	D		
								575	F	480	E		
3	25	30	50	50	100	FK206H	208	B	120	A	12 (304.8) High 18 (457.2) High	C	
							240	C	208	B		S	
							380	D	240	C			
							480	E	380	D			
							575	F	480	E			
4	40	50	75	100	150	FK206L	208	B	120	A	12 (304.8) High 18 (457.2) High	C	
							240	C	208	B		S	
							380	D	240	C			
							480	E	380	D			
							575	F	480	E			
5	60	60	125	150	150	250	FK206P FK206R	208	B	120	A	36 (914.4) High	S
								240	C	208	B		
								380	D	240	C		
								480	E	380	D		
								575	F	480	E		

① On 6-inch (152.4 mm) units, the only options available are (3) E22 pilot devices and separate source fuse or disconnect or CPT.

Advantage Replacement Starter Units

Table 6. Full Voltage Reversing Combination Starter — HMCP

NEMA Size	Maximum Horsepower					HMCP Size	Catalog Code	Service Voltage	Catalog Code	Control Voltage	Catalog Code	Space Options Inches (mm)	Catalog Code
	208V	240V	380V	480V	600V								
1	0.5	0.33	1	1	1.5	3	FK216A	208	B	120	A	18 (457.2) High 24 (609.6) High	S X
	1	1	2	3	3	7	FK216B	240	C	208	B		
	3	3	5	7.5	7.5	15	FK216C	380	D	240	C		
	7.5	7.5	10	10	10	30	FK216D	480	E	380	D		
								575	F	480	E		
							575	F	480	F			
2	10	15	25	25	25	50	FK216E	208	B	120	A	18 (457.2) High 24 (609.6) High	S X
								240	C	208	B		
								380	D	240	C		
								480	E	380	D		
								575	F	480	E		
								575	F	575	F		
3	25	30	50	50	50	100	FK216H	208	B	120	A	24 (609.6) High	S
								240	C	208	B		
								380	D	240	C		
								480	E	380	D		
								575	F	480	E		
								575	F	575	F		
4	40	50	75	100	100	150	FK216L	208	B	120	A	24 (609.6) High	S
								240	C	208	B		
								380	D	240	C		
								480	E	380	D		
								575	F	480	E		
								575	F	575	F		
5	50	60	100	125	150	250	FK216P	208	B	120	A	60 (1524.0) High	S
	75	100	150	200	200	400	FK216R	240	C	208	B		
								380	D	240	C		
								480	E	380	D		
								575	F	480	E		
								575	F	575	F		

Table 7. Full Voltage 2 Speed 1 Winding — Constant/Variable Torque — HMCP ①

NEMA Size	Maximum Horsepower					HMCP Size	Catalog Code	Service Voltage	Catalog Code	Control Voltage	Catalog Code	Space Options Inches (mm)	Catalog Code
	208V	240V	380V	480V	600V								
1	0.5	0.33	1	1	1.5	3	FK946A	208	B	120	A	24 (609.6) High 30 (762.0) High	S X
	1	1	2	3	3	7	FK946B	240	C	208	B		
	3	3	5	7.5	7.5	15	FK946C	380	D	240	C		
	7.5	7.5	10	10	10	30	FK946D	480	E	380	D		
								575	F	480	E		
							575	F	480	F			
2	10	15	25	25	25	50	FK946E	208	B	120	A	24 (609.6) High 30 (762.0) High	S X
								240	C	208	B		
								380	D	240	C		
								480	E	380	D		
								575	F	480	E		
								575	F	575	F		
3	25	30	50	50	50	100	FK946H	208	B	120	A	36 (914.4) High	S
								240	C	208	B		
								380	D	240	C		
								480	E	380	D		
								575	F	480	E		
								575	F	575	F		
4	40	50	75	100	100	150	FK946L	208	B	120	A	36 (914.4) High	S
								240	C	208	B		
								380	D	240	C		
								480	E	380	D		
								575	F	480	E		
								575	F	575	F		

① For constant horsepower instead of constant/variable torque, see Option SV6 on Page 18.

Advantage Replacement Starter Units

Table 8. Full Voltage 2 Speed 2 Winding — Constant/Variable Torque — HMCP ①

NEMA Size	Maximum Horsepower					HMCP Size	Catalog Code	Service Voltage	Catalog Code	Control Voltage	Catalog Code	Space Options Inches (mm)	Catalog Code
	208V	240V	380V	480V	600V								
1	0.5	0.33	1	1	1.5	3	FK956A	208	B	120	A	24 (609.6) High 30 (762.0) High	S X
	1	1	2	3	3	7	FK956B	240	C	208	B		
	3	3	5	7.5	7.5	15	FK956C	380	D	240	C		
	7.5	7.5	10	10	10	30	FK956D	480	E	380	D		
								575	F	480	E		
2	10	15	25	25	25	50	FK956E	208	B	120	A	24 (609.6) High 30 (762.0) High	S X
								240	C	208	B		
								380	D	240	C		
								480	E	380	D		
								575	F	480	E		
3	25	30	50	50	50	100	FK956H	208	B	120	A	30 (762.0) High	S
								240	C	208	B		
								380	D	240	C		
								480	E	380	D		
								575	F	480	E		
4	40	50	75	100	100	150	FK956L	208	B	120	A	30 (762.0) High	S
								240	C	208	B		
								380	D	240	C		
								480	E	380	D		
								575	F	480	E		
5	50	60	100	125	150	250	FK956P	208	B	120	A	72 (1828.8) High	S
	75	100	150	200	200	400	FK956R	240	C	208	B		
								380	D	240	C		
								480	E	380	D		
								575	F	480	E		
									575	F			

① For constant horsepower instead of constant/variable torque, see Option SV6 on Page 18.

Table 9. Reduced Voltage Autotransformer — HMCP

NEMA Size	Maximum Horsepower					HMCP Size	Catalog Code	Service Voltage	Catalog Code	Control Voltage	Catalog Code	Space Options Inches (mm)	Catalog Code
	208V	240V	380V	480V	600V								
2	10	15	25	25	25	50	FK606E	208	B	120	A	36 (914.4) High	S
								240	C	208	B		
								380	D	240	C		
								480	E	380	D		
								575	F	480	E		
3	25	30	50	50	50	100	FK606H	208	B	120	A	48 (1219.2) High	S
								240	C	208	B		
								380	D	240	C		
								480	E	380	D		
								575	F	480	E		
4	40	50	75	100	100	150	FK606L	208	B	120	A	48 (1219.2) High	S ②
								240	C	208	B		
								380	D	240	C		
								480	E	380	D		
								575	F	480	E		

② If existing MCC is back-to-back design, 36 inches (914.4 mm) in bottom rear is unusable.

Advantage Replacement Starter Units

Table 10. Reduced Voltage Part Winding — HMCP

NEMA Size	Maximum Horsepower					HMCP Size	Catalog Code	Service Voltage	Catalog Code	Control Voltage	Catalog Code	Space Options Inches (mm)	Catalog Code
	208V	240V	380V	480V	600V								
1	10	10	15	15	15	30	FK706D	208 240 380 480 575	B C D E F	120 208 240 380 480 575	A B C D E F	24 (609.6) High	S
2	20	25	40	40	40	100	FK706F	208 240 380 480 575	B C D E F	120 208 240 380 480 575	A B C D E F	24 (609.6) High	S
3	40	50	75	75	75	150	FK706J	208 240 380 480 575	B C D E F	120 208 240 380 480 575	A B C D E F	30 (762.0) High	S
4	— 75	— 75	— 150	100 150	125 150	250 400	FK706L FK706M	208 240 380 480 575	B C D E F	120 208 240 380 480 575	A B C D E F	36 (914.4) High	S

Table 11. Reduced Voltage Wye Delta Open Transition — HMCP

NEMA Size	Maximum Horsepower					HMCP Size	Catalog Code	Service Voltage	Catalog Code	Control Voltage	Catalog Code	Space Options Inches (mm)	Catalog Code
	208V	240V	380V	480V	600V								
2	20	25	40	40	40	100	FK806F	208 240 380 480 575	B C D E F	120 208 240 380 480 575	A B C D E F	30 (762.0) High	S
3	40	50	75	75	75	150	FK806J	208 240 380 480 575	B C D E F	120 208 240 380 480 575	A B C D E F	42 (1066.8) High	S
4	60 —	75 —	125 150	150 —	150 —	250 400	FK806M FK806N	208 240 380 480 575	B C D E F	120 208 240 380 480 575	A B C D E F	42 (1066.8) High	S

Advantage Replacement Starter Units

Table 12. Reduced Voltage Wye Delta Closed Transition — HMCP (Non-Chiller Application)

NEMA Size	Maximum Horsepower					HMCP Size	Catalog Code	Service Voltage	Catalog Code	Control Voltage	Catalog Code	Space Options Inches (mm)	Catalog Code
	208V	240V	380V	480V	600V								
2	20	25	40	40	40	100	FK896F	208 240 380 480 575	B C D E F	120 208 240 380 480 575	A B C D E F	48 (1219.2) High	S
3	40	50	50	50	50	100	FK896J	208 240 380 480 575	B C D E F	120 208 240 380 480 575	A B C D E F	60 (1524.0) High	S
4	60 —	75 —	125 150	150 —	150 —	250 400	FK896M FK896N	208 240 380 480 575	B C D E F	120 208 240 380 480 575	A B C D E F	60 (1524.0) High	S

IT06 — Intelligent Technologies *IT*. Solid-State Reduced Voltage Starter — HMCP

The *IT*. solid-state reduced voltage starter uses SCRs when starting and a low impedance run circuit during operation. Solid-state starters have (5) 24V DC inputs and 2 relay outputs. Soft start units include a disconnect, starter, 24V DC power supply and 100VA CPT.

Motor Service Factor (SF) Effect on *IT*. Starter Selection

- A 1.0 service factor motor may draw up to 1.00 x full load amperes.
- A 1.15 service factor motor may draw up to 1.15 x full load amperes.
- 15% more current. *IT*. starters are current rated devices. In some cases, a larger *IT*. SSRV starter must be supplied for 1.15 SF motors. See the maximum horsepower chart below.

Note: Most motors used in industrial applications are 1.15 Service Factor (SF).

Table 13. Replacement *IT*. Soft Start Units

Service Factor	Horsepower	<i>IT</i> . Soft-Start Amperes	HMCP Amperes	Catalog Code	Service Voltage	Catalog Code	Control Voltage	Catalog Code	Space Options Inches (mm)	Catalog Code
1.15	10	37	100	FK306A	208	B	120	A	12 (304.8) High	S
	15	66		FK306B			208	B		
	30	105	150	FK306C			240	C	18 (457.2) High	
	40	135		FK306D			380	D		
	50	180	400	FK306E			480	E	36 (914.4) High	
	60	240		FK306F			575	F		
	75	304		FK306G			—	—		
1.15	10	37	100	FK306A	240	C	120	A	12 (304.8) High	S
	20	66		FK306B			208	B		
	30	105	150	FK306C			240	C	18 (457.2) High	
	40	135		FK306D			380	D		
	60	180	250	FK306E			480	E	36 (914.4) High	
	75	240		FK306F			575	F		
	100	304	FK306G	—			—			
1.15	15	37	100	FK306A	380	D	120	A	12 (304.8) High	S
	30	66		FK306B			208	B		
	45	105	150	FK306C			240	C	18 (457.2) High	
	55	135		FK306D			380	D		
	75	180	400	FK306E			480	E	36 (914.4) High	
	110	240		FK306F			575	F		
	132	304	FK306G	—			—			
1.15	20	37	100	FK306A	480	E	120	A	12 (304.8) High	S
	40	66		FK306B			208	B		
	60	105	150	FK306C			240	C	18 (457.2) High	
	75	135		FK306D			380	D		
	125	180	400	FK306E			480	E	36 (914.4) High	
	150	240		FK306F			575	F		
	200	304		FK306G			—	—		
1.15	30	37	100	FK306A	575	F	120	A	12 (304.8) High	S
	50	66		FK306B			208	B		
	75	105	150	FK306C			240	C	18 (457.2) High	
	100	135		FK306D			380	D		
	150	180	250	FK306E			480	E	36 (914.4) High	
	200	240		FK306F			575	F		
	250	304	FK306G	—			—			

Advantage Replacement Starter Units

Table 14. Full Voltage Non-Reversing — Fusible ①

NEMA Size	Maximum Horsepower					Fuse Clip Amperes	Catalog Code	Service Voltage	Catalog Code	Control Voltage	Catalog Code	Space Options Inches (mm)	Catalog Code
	208V	240V	380V	480V	600V								
1	7.5	7.5	10	10	10	30	FK204C	208 240 380 480 575	B C D E F	120 208 240 380 480 575	A B C D E F	6 (152.4) High 12 (304.8) High 18 (457.2) High	C ② S X
2	— 10	— 15	15 25	15 25	25 —	30 60	FK204E FK204F	208 240 380 480 575	B C D E F	120 208 240 380 480 575	A B C D E F	12 (304.8) High 18 (457.2) High	S X
3	— 25	20 30	30 50	40 50	50 —	60 100	FK204H FK204J	208 240 380 480 575	B C D E F	120 208 240 380 480 575	A B C D E F	24 (609.6) High	S
4	— 50	— 50	— 50	60 100	75 100	100 200	FK204L FK204M	208 240 380 480 575	B C D E F	120 208 240 380 480 575	A B C D E F	48 (1219.2) High	S
5	60 100	60 100	100 150	150 200	150 200	200 400	FK204P FK204R	208 240 380 480 575	B C D E F	120 208 240 380 480 575	A B C D E F	54 (1371.6) High	S

① Fuse clip ratings shown are based on Class RK1, 5 fuses.

② On 6-inch (152.4 mm) units, the only option available are (3) E22 pilot devices and separate source fuse or disconnect or CPT.

Table 15. Full Voltage Reversing — Fusible ③

NEMA Size	Maximum Horsepower					Fuse Clip Amperes	Catalog Code	Service Voltage	Catalog Code	Control Voltage	Catalog Code	Space Options Inches (mm)	Catalog Code
	208V	240V	380V	480V	600V								
1	7.5	7.5	10	10	10	30	FK214C	208 240 380 480 575	B C D E F	120 208 240 380 480 575	A B C D E F	24 (609.6) High 30 (762.0) High	S X
2	— 10	— 15	15 25	15 25	25 —	30 60	FK214E FK214F	208 240 380 480 575	B C D E F	120 208 240 380 480 575	A B C D E F	24 (609.6) High 30 (762.0) High	S X
3	— 25	20 30	30 50	40 50	50 —	60 100	FK214H FK214J	208 240 380 480 575	B C D E F	120 208 240 380 480 575	A B C D E F	30 (762.0) High	S
4	— 50	— 50	— 60	60 100	75 100	100 200	FK214L FK214M	208 240 380 480 575	B C D E F	120 208 240 380 480 575	A B C D E F	48 (1219.2) High	S

③ Fuse clip ratings shown are based on Class RK1, 5 fuses.

Advantage Replacement Starter Units

Table 16. Full Voltage 2 Speed 1 Winding — Fusible — Constant/Variable Torque ①②

NEMA Size	Maximum Horsepower					Fuse Clip Amperes	Catalog Code	Service Voltage	Catalog Code	Control Voltage	Catalog Code	Space Options Inches (mm)	Catalog Code
	208V	240V	380V	480V	600V								
1	7.5	7.5	10	10	10	30	FK944C	208 240 380 480 575	B C D E F	120 208 240 380 480 575	A B C D E F	24 (609.6) High	S
2	— 10	— 15	15 25	15 25	25 —	30 60	FK944E FK944F	208 240 380 480 575	B C D E F	120 208 240 380 480 575	A B C D E F	24 (609.6) High	S
3	— 25	20 30	30 50	40 50	50 —	60 100	FK944H FK944J	208 240 380 480 575	B C D E F	120 208 240 380 480 575	A B C D E F	48 (1219.2) High	S
4	— 50	— 50	— 60	60 100	75 100	100 200	FK944L FK944M	208 240 380 480 575	B C D E F	120 208 240 380 480 575	A B C D E F	54 (1371.6) High	S

① Fuse clip ratings shown are based on Class RK1, 5 fuses.

② For constant horsepower instead of constant/variable torque, see Option SV6 on Page 18.

Table 17. Full Voltage 2 Speed 2 Winding — Fusible — Constant/Variable Torque ③④

NEMA Size	Maximum Horsepower					Fuse Clip Amperes	Catalog Code	Service Voltage	Catalog Code	Control Voltage	Catalog Code	Space Options Inches (mm)	Catalog Code
	208V	240V	380V	480V	600V								
1	7.5	7.5	10	10	10	30	FK954C	208 240 380 480 575	B C D E F	120 208 240 380 480 575	A B C D E F	24 (609.6) High	S
2	— 15	— 15	15 25	15 25	25 —	30 60	FK954E FK954F	208 240 380 480 575	B C D E F	120 208 240 380 480 575	A B C D E F	24 (609.6) High	S
3	— 25	20 30	30 50	40 50	50 —	60 100	FK954H FK954J	208 240 380 480 575	B C D E F	120 208 240 380 480 575	A B C D E F	36 (914.4) High	S
4	— 50	— 50	— 60	60 100	75 100	100 200	FK954L FK954M	208 240 380 480 575	B C D E F	120 208 240 380 480 575	A B C D E F	48 (1219.2) High	S

③ Fuse clip ratings shown are based on Class RK1, 5 fuses.

④ For constant horsepower instead of constant/variable torque, see option SV6 on Page 18.

Advantage Replacement Starter Units

Table 18. Reduced Autotransformer — Fusible ①

NEMA Size	Maximum Horsepower					Fuse Clip Amperes	Catalog Code	Service Voltage	Catalog Code	Control Voltage	Catalog Code	Space Options Inches (mm)	Catalog Code
	208V	240V	380V	480V	600V								
2	—	—	15	15	25	30 60	FK604E FK604F	208 240 380 480 575	B C D E F	120 208 240 380 480 575	A B C D E F	36 (914.4) High	S
	10	15	25	25	—								
3	—	20	30	40	50	60 100	FK604H FK604J	208 240 380 480 575	B C D E F	120 208 240 380 480 575	A B C D E F	72 (1828.8) High	S
	25	30	50	50	—								
4	—	—	—	60	75	100 200	FK604L FK604M	208 240 380 480 575	B C D E F	120 208 240 380 480 575	A B C D E F	72 (1828.8) High	S ②
	50	50	60	100	100								

① Fuse clip ratings shown are based on Class RK1, 5 fuses.

② If existing MCC is back-to-back design, 36 inches (914.4 mm) in bottom rear is unusable.

Table 19. Reduced Voltage Part Winding — Fusible ③

NEMA Size	Maximum Horsepower					Fuse Clip Amperes	Catalog Code	Service Voltage	Catalog Code	Control Voltage	Catalog Code	Space Options Inches (mm)	Catalog Code
	208V	240V	380V	480V	600V								
1	10	10	15	15	15	60	FK704D	208 240 380 480 575	B C D E F	120 208 240 380 480 575	A B C D E F	24 (609.6) High	S
	—	—	—	—	—								
2	—	15	25	30	40	60 100	FK704F FK704G	208 240 380 480 575	B C D E F	120 208 240 380 480 575	A B C D E F	24 (609.6) High	S
	20	25	40	40	—								
3	—	—	—	50	60	100 200	FK704J FK704K	208 240 380 480 575	B C D E F	120 208 240 380 480 575	A B C D E F	48 (1219.2) High	S
	40	50	75	75	75								
4	50	—	100	100	150	200 400	FK704M FK704N	208 240 380 480 575	B C D E F	120 208 240 380 480 575	A B C D E F	48 (1219.2) High	S
	75	75	150	150	—								

③ Fuse clip ratings shown are based on Class RK1, 5 fuses.

Advantage Replacement Starter Units

Table 20. Reduced Voltage Wye Delta Open Transition — Fusible ①

NEMA Size	Maximum Horsepower					Fuse Clip Amperes	Catalog Code	Service Voltage	Catalog Code	Control Voltage	Catalog Code	Space Options Inches (mm)	Catalog Code
	208V	240V	380V	480V	600V								
2	15	15	30	40	40	60 100	FK804F FK804G	208	B C D E F	120	A B C D E F	36 (914.4) High	S
	20	25	40	—	—			240		208			
								380		240			
								480		380			
								575		480			
										575			
3	25	30	50	60	75	100 200	FK804J FK804K	208	B C D E F	120	A B C D E F	54 (1371.6) High	S
	40	50	75	75	—			240		208			
								380		240			
								480		380			
								575		480			
										575			
4	50	60	100	125	150	200 400	FK804M FK804N	208	B C D E F	120	A B C D E F	60 (1524.0) High	S
	60	75	150	150	—			240		208			
								380		240			
								480		380			
								575		480			
										575			

① Fuse clip ratings shown are based on Class RK1, 5 fuses.

Table 21. Reduced Voltage Wye Delta Closed Transition — Fusible (Non-Chiller Application) ②

NEMA Size	Maximum Horsepower					Fuse Clip Amperes	Catalog Code	Service Voltage	Catalog Code	Control Voltage	Catalog Code	Space Options Inches (mm)	Catalog Code
	208V	240V	380V	480V	600V								
2	15	15	30	40	40	60 100	FK894F FK894G	208	B C D E F	120	A B C D E F	54 (1371.6) High	S
	20	25	40	—	—			240		208			
								380		240			
								480		380			
								575		480			
										575			
3	25	30	50	60	75	100 200	FK894J FK894K	208	B C D E F	120	A B C D E F	72 (1828.8) High	S
	40	50	75	75	—			240		208			
								380		240			
								480		380			
								575		480			
										575			
4	50	60	100	125	150	200 400	FK894M FK894N	208	B C D E F	120	A B C D E F	72 (1828.8) High	S
	60	75	150	150	—			240		208			
								380		240			
								480		380			
								575		480			
										575			

② Fuse clip ratings shown are based on Class RK1, 5 fuses.

Advantage Unit Options

Table 22. Option Groups ①

Groups	Description	Page Number
A	Advantage Options	16
B	Circuit Breaker Options	16
C	Control Power Source Options	16
G	Ground Fault Protection Options	16
M	Metering Options	17
O	Overload Options	17
P	Pilot Device Options	17
R	Relay and Timer (Control, Voltage, Current) Options	18
S	Starter Contact Options	18
SV	Vacuum Starter Options	18
T	Terminal Block Options	18
U	Unit Wiring Options	18

① Select your option suffix and attach it to the end of the catalog number.

Table 23. Option Suffix

Suffix	Description	Space Required ②
--------	-------------	------------------

A — Advantage Options

A15	Advantage Hand/Off/Auto ACM for FVNR or RVNR Starters	C ③
A16	Advantage Stop/Start for FVNR or RVNR Starters	C ③
A17	Advantage Hand/Off/Auto-Start/Stop ACM for FVNR or RVNR Starters	C ③
A18	Advantage Fast/Slow/Stop 2-Speed Starters	C ③
A19	Advantage Forward/Reverse/Stop for Reversing Starters	C ③
A20	Advantage Fast/Slow/Off/Auto for 2-Speed Starters	C ③
A21	Advantage Forward/Reverse/Off/Auto for Reversing Starters	C ③
A22	ACM Metering Module	C ③
A23	WBELL Form C Bell Alarm Contact	C ③
A24	Reset with Overload Alarm and Trip Indication	C ③
A25	120V AC PLC Circuit Compatible Load Resistor	C ③
A26	WPONI PowerNet Communications Module	C ③
A27	Advantage Status Only ACM	C ③
A28	WPONIDNA DeviceNet Communications Module	C ③

B — Breaker Options

B10	Shunt Trip 120V AC Wired to Terminal Blocks for Remote Tripping	C
B11	Auxiliary Switch Form C (1NO/1NC) Wired to Terminal Blocks	C
B12	Form C Bell Alarm Contact (1NO/1NC) Wired to Terminal Blocks	C
B13	Undervoltage Release	C
B14	IQ Energy Sentinel — F Frame	④
B15	IQ Energy Sentinel — J Frame	④
B16	IQ Energy Sentinel — K Frame	④
B17	IQ Central Energy Display	④
B18	Thermal Magnetic Circuit Breaker Instead of HMCP	—

C — Control Power Source Options

C10	Control Fuse Wired for Separate Source in Lieu of Control Power Transformer	C
C11	Control Fuse with Disconnect Wired for Separate Source in Lieu of Control Power Transformer	C
C12	Control Power Transformer 100 VA for Size 1 and 2 Starters (Fused)	C ③
C13	Control Power Transformer 150 VA for Size 3 and 4 Starters (Fused)	C
C14	Control Power Transformer 100 VA with Interposing Relay for Size 5 Starters, Fused	C
C15	Extra 50 VA for Control Power Transformer	S
C16	Extra 100 VA for Control Power Transformer	S
C17	Service Voltage Control, Fused in Lieu of Control Power Transformer	C
C18	Full Capacity Control Power Transformer for Size 5 Starters, Fused	C

G — Ground Fault Protection Options

G10	Class 1 Ground Fault Protection — GRT1 Size 1 – 4	X
G11	Class 1 Ground Protection — GRT1 Size 5 – 6	X
G12	Ground Fault Test Panel	X

② Minimum unit size required (refer to Replacement Unit pages).

③ Not available in 6 inches (152.4 mm).

④ Consult factory for spacing.

Advantage Unit Options

Table 23. Option Suffix (Continued)

Suffix	Description	Space Required ^①
M — Metering Options		
M10	Mini Voltmeter	C ^②
M11	Mini Ammeter with Current Transformer	S
M12	Mini Elapsed Time Meter	C ^②
M13	Current Transformer for Remote Metering	S
M14	Current Transducer 4-20 mA Output	X
O — Overload Options		
O10	IQ 500 Solid-State Overload Relay	—
O11	IQ 500 Load Protection Module	—
O16	Bell Alarm (1NO) Wired	C
O17	Bi-Metallic Overload Substitution	C
O18	Adjustable A200 Overload Substitution	C
O19	Overload Relay Heater/Heater Pack	C
O20	CEP7 Solid-State Overload Relay	C
P — Pilot Device Options ^③		
P10	Red "RUN" Light	C
P11	Green "STOPPED" Light	C
P12	Amber "OVERLOAD TRIPPED" Light	C
P13	Green "RUN" Light	C
P14	Red "STOPPED" Light	C
P15	Red "RUN" Push-to-Test Light	C
P16	Green "STOPPED" Push-to-Test Light	C
P17	Amber "OVERLOAD TRIPPED" Push-to-Test Light	C
P18	Green "RUN" Push-to-Test Light	C
P19	Red "STOPPED" Push-to-Test Light	C
P20	Special Function Light	C
P30	"START" Pushbutton	C
P31	"STOP" Pushbutton	C
P32	"START/STOP" Pushbutton	C
P33	"ON" Pushbutton	C
P34	"OFF" Pushbutton	C
P35	"ON/OFF" Pushbutton	C
P36	"FORWARD/REVERSE/STOP" Pushbutton	C
P37	"FAST/SLOW/STOP" Pushbutton	C
P38	"FAST/OFF/SLOW" Pushbutton	C
P39	"HIGH/LOW/STOP" Pushbutton	C
P40	"HIGH/LOW/OFF" Pushbutton	C
P41	Special Function Pushbutton	C
P50	"ON-OFF" Selector Switch	C
P51	"HIGH-LOW" Selector Switch	C
P52	"OFF-AUTO" Selector Switch	C
P53	"START-STOP" Selector Switch	C
P54	"SLOW-FAST" Selector Switch	C
P55	"FORWARD-REVERSE" Selector Switch	C
P56	Special Function 2-Position Selector Switch	C
P57	"HAND-OFF-AUTO" Selector Switch	C
P58	"LOCAL-OFF-REMOTE" Selector Switch	C
P59	"FAST-OFF-SLOW" Selector Switch	C
P60	"HIGH-OFF-LOW" Selector Switch	C
P61	Special Function 3-Position Selector Switch	C
P62	"HIGH-LOW-OFF-AUTO" Selector Switch	C
P63	Special Function 4-Position Selector Switch	C

^① Minimum unit size required (refer to Replacement Unit pages).

^② Customer to supply range of meter required.

^③ Available only with F2100, Advantage, Series 2100/5 Star, Freedom Unitrol, F10 Unitrol and Type W. Consult factory for specific size limitations.

Advantage Unit Options

Table 23. Option Suffix (Continued)

Suffix	Description	Space Required ^①						
R — Relay and Timer Options								
R10	Auxiliary Control Relay 2-Pole (1NO/1NC) Convertible Contacts Wired in Parallel with Starter Coil	S						
R11	Auxiliary Control Relay 4-Pole (2NO/2NC) Convertible Contacts Wired in Parallel with Starter Coil	S						
R12	Auxiliary Control Relay 2-Pole Overload Alarm (1NO/1NC) Convertible Contacts	S						
R13	Mechanical Latching Relay (Specify Connection)	X						
R14	Ice Cube Relay 300 Volts 3-Pole Blade Type (Specify Connection)	S						
R15	Phase Voltage Relay	X						
R16	Current Sensing Relay with Contacts Wired to Terminal Blocks	X						
R17	Deceleration Timing Relay (Pneumatic "OFF" Delay)	S						
R18	Compelling Timing Relay (Pneumatic "ON" Delay)	S						
R19	Time Clock 24 Hour	②						
R20	Time Clock 7 Day	②						
R21	Solid-State Timer Type TR (Specify Connection)	S						
R22	DN65 DeviceNet Interface Module	S						
R23	D15 2-Pole Control Relay	C						
R24	D15 4-Pole Control Relay	C						
S — Starter Contact Options (Maximum of 8 Contacts)								
S__	To order extra starter contacts, you must specify the number of NO/NC contacts, given a maximum of eight (8). To define the unit option required, create a suffix based on the following example:							
	<table border="1"> <thead> <tr> <th></th> <th>Quantity of Normally Open Contacts</th> <th>Quantity of Normally Closed Contacts</th> </tr> </thead> <tbody> <tr> <td>S</td> <td>2</td> <td>3</td> </tr> </tbody> </table>		Quantity of Normally Open Contacts	Quantity of Normally Closed Contacts	S	2	3	
	Quantity of Normally Open Contacts	Quantity of Normally Closed Contacts						
S	2	3						
SV — Vacuum Starter Options								
SV4	Vacuum Starter Size 4 Substitution FVNR	②						
SV5	Vacuum Starter Size 5 Substitution FVNR	②						
SV6	Constant Horsepower Instead of Constant/Variable Torque	—						
T — Terminal Block Options								
T10	Pull-apart Type Terminal Blocks (Standard on all Vintages Except Type W and 11-300)	S						
T11	Utility Screw Type Terminal Blocks (Add 6 Inches (152.4 mm) for Every 18 Points)	—						
T12	Front-mounted Pull-apart Terminal Block for F2100, Advantage, Series 2100/5 Star	S						
T13	T-Lead Power Terminal Blocks for Size 1 Starter	—						
U — Unit Wiring Options								
U10	Surge Suppressor on Coil	C						
U11	Type SIS Control Wire	C						
U12	Type SIS Power Wire	C						
U13	Type 14 Gauge Control Wire (Standard for all Vintages Except F2100, Series 2100/5 Star, Type W and 11-300)	C						
U14	Wiremarkers — Sleeve Type on all Control Wire	C						
U15	Locking Fork Terminals on all Control Wiring	S						
U16	Ring Wire Terminals on Power Wiring	S						
U17	Wiring Diagram Inside Starter Unit Door	C						
U18	Pre-insulated Ring Terminals on all Control Wiring	C						
U19	Pre-insulated Ring Terminals on all Control Wiring, except for Freedom Starter Terminals	C						
U20	Wiremarkers for Power Wiring	C						

① Minimum unit size required (refer to Replacement Unit pages).

② Consult factory for spacing.

Advantage Structure Parts

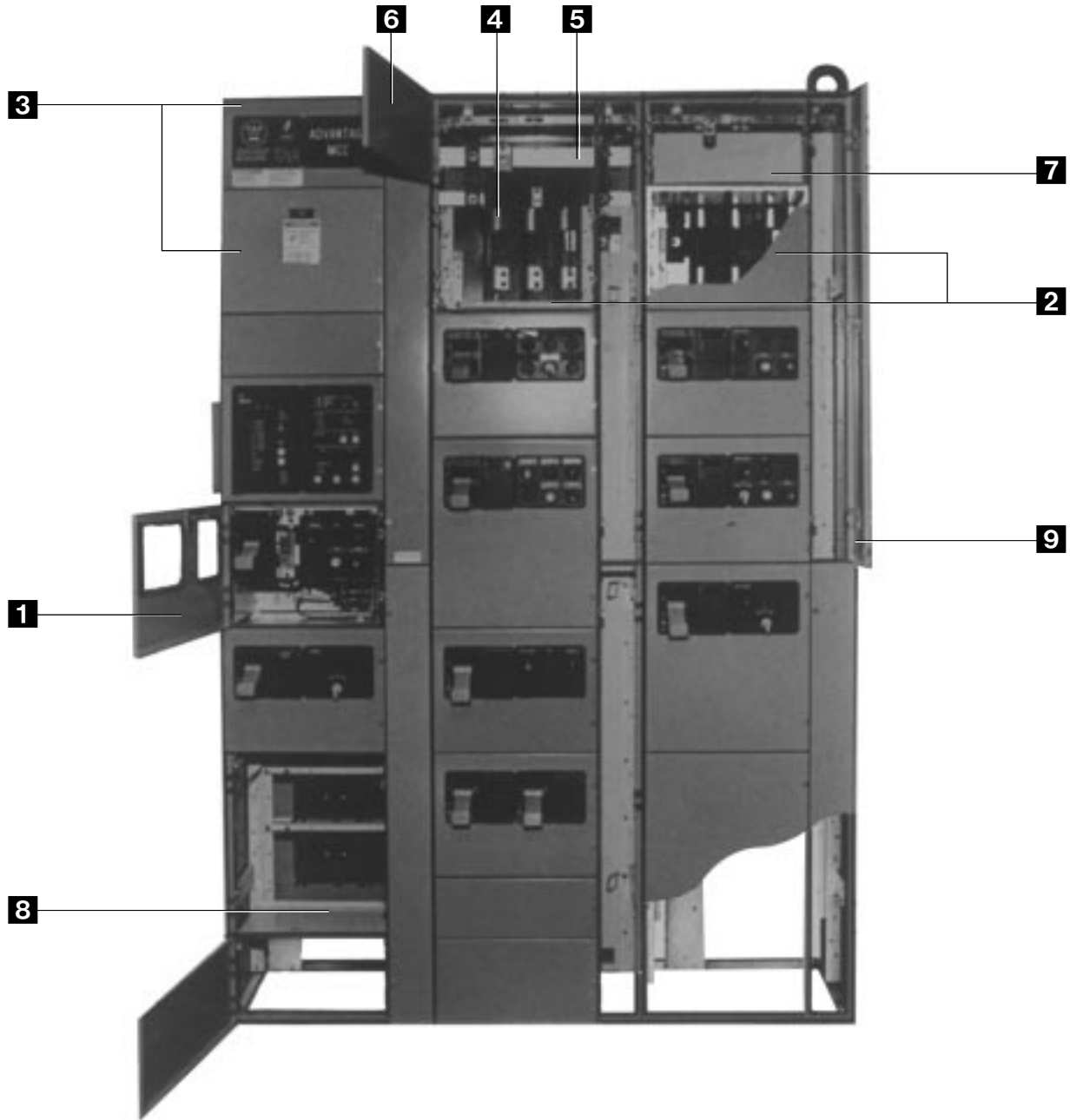

Table 24. Structure Parts

Reference	Description	Page
1	Blank Unit Door with Mounting Hardware	20
2	Vertical Bus Barrier Kit Shutter Kit	20 20
3	Top and Side Sheet Metal Covers Touch-up Paint Kit	20 20
4	Vertical Bus Bar	20
5	Horizontal Bus Bar	21

Reference	Description	Page
6	Horizontal Wireway Door Kit	21
7	Horizontal Bus Barriers	21
8	Divider Pan/Guide Rails with Mounting Hardware	21
9	Vertical Wireway Door Kit Horizontal to Vertical Bus Connection Kit Horizontal Bus Insulator Kit Horizontal Bus Splice Kit Door Mounting Hardware Kit	21 22 22 22 22

Advantage Structure Parts

Vertical Bus Bar 4

65,000 ampere rms bus bracing

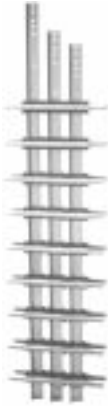

Vertical Bus Bar

Table 25. Vertical Bus Bar — Copper Only

Ampere Rating	Mounting Type	Style Number
300	Front	4719A80G06
600	Front/Back-to-Back	4719A80G07
800	Front	4719A80G08
1200	Front	4719A80G10

Vertical Bus Barrier Kit 2

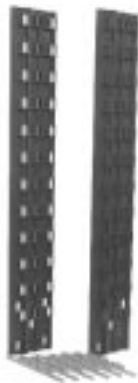

Labyrinth Barrier Kit

Table 26. Vertical Bus Barrier Kit

Description	Style Number
Labyrinth barrier kit includes front and rear barrier, bus supports and hardware (does not include shutters).	4719A91G14

Sheet Metal Covers with Mounting Hardware 3

Table 27. Sheet Metal Covers with Mounting Hardware

Description	Style Number
Side Sheets	
16-Inches (406.4 mm) Deep, Front Mounted	4719A91G31
21-Inches (533.4 mm) Deep, Front Mounted	4719A91G32
21-Inches (533.4 mm) Deep, Back-to-Back Mounted	4719A91G33
Rear Sheets	
20-Inches (508.0 mm) Wide x 90-Inches (2286.0 mm) High	4719A91G34
24-Inches (609.6 mm) Wide x 90-Inches (2286.0 mm) High	4719A91G35
Top Sheets	
20-Inches (508.0 mm) Wide x 16-Inches (406.4 mm) Front Mounted	4719A91G36
20-Inches (508.0 mm) Wide x 21-Inches (533.4 mm) Front Mounted	4719A91G37
20-Inches (508.0 mm) Wide x 21-Inches (533.4 mm) Back-to-Back Mounted	4719A91G38
24-Inches (609.6 mm) Wide x 16-Inches (406.4 mm) Front Mounted	4719A91G39
24-Inches (609.6 mm) Wide x 21-Inches (533.4 mm) Front Mounted	4719A91G40

Blank Unit Door with Mounting Hardware 1

Table 28. Blank Unit Door with Mounting Hardware

Description	Style Number
6-Inches (152.4 mm) High x 15-1/2 Inches (393.7 mm) Wide	4719A91G20
12-Inches (304.8 mm) High x 15-1/2 Inches (393.7 mm) Wide	4719A91G21
18-Inches (457.2 mm) High x 15-1/2 Inches (393.7 mm) Wide	4719A91G22
24-Inches (609.6 mm) High x 15-1/2 Inches (393.7 mm) Wide	4719A91G23
30-Inches (762.0 mm) High x 15-1/2 Inches (393.7 mm) Wide	4719A91G24
36-Inches (914.4 mm) High x 15-1/2 Inches (393.7 mm) Wide	4719A91G25

Shutter Kit 2

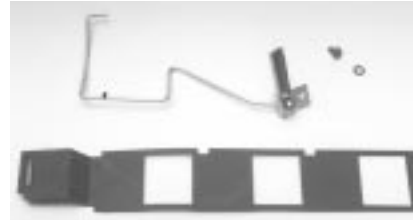

Shutter Kit

Table 29. Shutter Kit

Description	Style Number
Kit includes shutter, spring loaded coupler and mounting screws.	4719A91G15

Touch-up Paint Kit 3

Table 30. Touch-up Paint Kit

Description	Style Number
Kit includes three spray cans of ANSI-61 Gray.	4719A91G10

Advantage Structure Parts

Horizontal Bus Bar 

65,000 ampere rms bus bracing

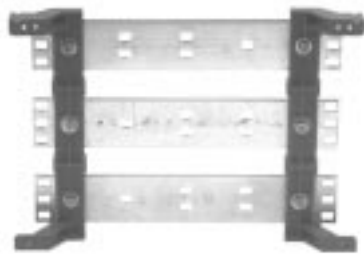

Horizontal Bus Bar

Table 31. Horizontal Bus Bar — Tin-Plated Copper

Structures		Bar Size Inches (mm)	Bars/ Phase	Ampere Rating		Style Number
Number	Width Inches (mm)			UL (50°C)	NEMA (65°C)	
1	20 (508.0)	1/4 x 2 (6.4 x 50.8)	1	600	600	4719A97G28 4719A97G29 4719A97G30
2	40 (1016.0)					
3	60 (1524.0)					
1	20 (508.0)	1/4 x 2 (6.4 x 50.8)	1	—	800	4719A97G31 4719A97G32 4719A97G33
2	40 (1016.0)					
3	60 (1524.0)					
1	20 (508.0)	1/4 x 3 (6.4 x 76.2)	1	—	1000	4719A97G34 4719A97G35 4719A97G36
2	40 (1016.0)					
3	60 (1524.0)					
1	20 (508.0)	1/4 x 3 (6.4 x 76.2)	2	—	1200	4719A97G37 4719A97G38 4719A97G39
2	40 (1016.0)					
3	60 (1524.0)					
1	20 (508.0)	1/4 x 3 (6.4 x 76.2)	1	800	—	4719A97G40 4719A97G41 4719A97G42
2	40 (1016.0)					
3	60 (1524.0)					
1	20 (508.0)	1/4 x 2-1/2 (6.4 x 63.5)	2	1200	—	4719A97G43 4719A97G44 4719A97G45
2	40 (1016.0)					
3	60 (1524.0)					

Horizontal Wireway Door Kit 



Horizontal Wireway Door Kit

Table 32. Horizontal Wireway Door Kit

Description Inches (mm)	Style Number
9 (228.6) High x 15-1/2 (393.7) Wide (Standard Kit of 2)	4719A91G18
(1) 15 (381.0) High x 15-1/2 (393.7) Wide, (1) 3 (76.2) High	4719A91G19

Kit includes door, hinges, hinge pins and mounting hardware

Horizontal Bus Barrier Kit 



Horizontal Bus Barrier Kit

Table 33. Horizontal Bus Barrier Kit

Description Inches (mm)	Style Number
9 (228.6) High, Front Mounted	4719A91G02
15 (381.0) High, Front Mounted	4719A91G03
15 (381.0) High, Rear Mounted	4719A91G04

Kit includes divider pan, horizontal and vertical barriers, junction piece, and mounting hardware.

Divider Pan/Guide Rails with Mounting Hardware 



Divider Pan/Guide Rails with Mounting Hardware

Table 34. Divider Pan/Guide Rails with Mounting Hardware

Description	Style Number
Divider pan/guide rails with mounting hardware.	4719A91G05

Vertical Wireway Door Kit 



Vertical Wireway Door Kit

Table 35. Vertical Wireway Door Kit

Description Inches (mm)	Style Number
Kit includes 4 x 45 (101.6 x 1143.0) door, hinges, hinge pins and mounting hardware.	4719A91G17

Advantage Structure Parts

**Horizontal to Vertical Bus
Connection Kit**



Horizontal to Vertical Bus Connection Kit

Table 36. Horizontal to Vertical Bus Connection Kit

Description	Horizontal Bus		Vertical Bus		Style Number
	Ampere Rating	Bars/Phase	Ampere Rating	Material	
Kit includes bus spacers with mounting hardware.	600	1	300	Cu	4719A97G64
			600	Cu	4719A97G65
	800	2	300	Cu	4719A97G72
			600	Cu	4719A97G73
			800	Cu	4719A97G74
	1200	3	300	Cu	4719A97G80
			600	Cu	4719A97G81
			800	Cu	4719A97G82
			1200	Cu	4719A97G84

Horizontal Bus Splice Kit



Horizontal Bus Splice Kit

Table 37. Horizontal Bus Splice Kit — Tin-Plated Copper

Description	Bus Ampere Rating		Bus Size Inches (mm)	Bars/ Phase	Style Number
	UL (50°C)	NEMA (65°C)			
Kit includes bus splice plates with mounting hardware.	600	600	2 (50.8)	1	4719A97G86
	—	800	2 (50.8)	1	4719A97G87
	800	—	3 (76.2)	1	4719A97G88
	—	1000	3 (76.2)	1	4719A97G89
	1000	1200	3 (76.2)	2	4719A97G90
	1200	—	2-1/2 (63.5)	2	4719A97G91

Horizontal Bus Insulator Kit



Horizontal Bus Insulator Kit

Table 38. Horizontal Bus Insulator Kit

Description	Style Number
Kit includes 2 insulators with mounting hardware.	4719A91G11

Door Mounting Hardware Kit



Door Mounting Hardware Kit

Table 39. Door Mounting Hardware Kit

Description	Style Number
Kit includes 2 hinges, hinge pins and (2) 1/4 turn latches.	4719A91G26

Advantage Unit Parts

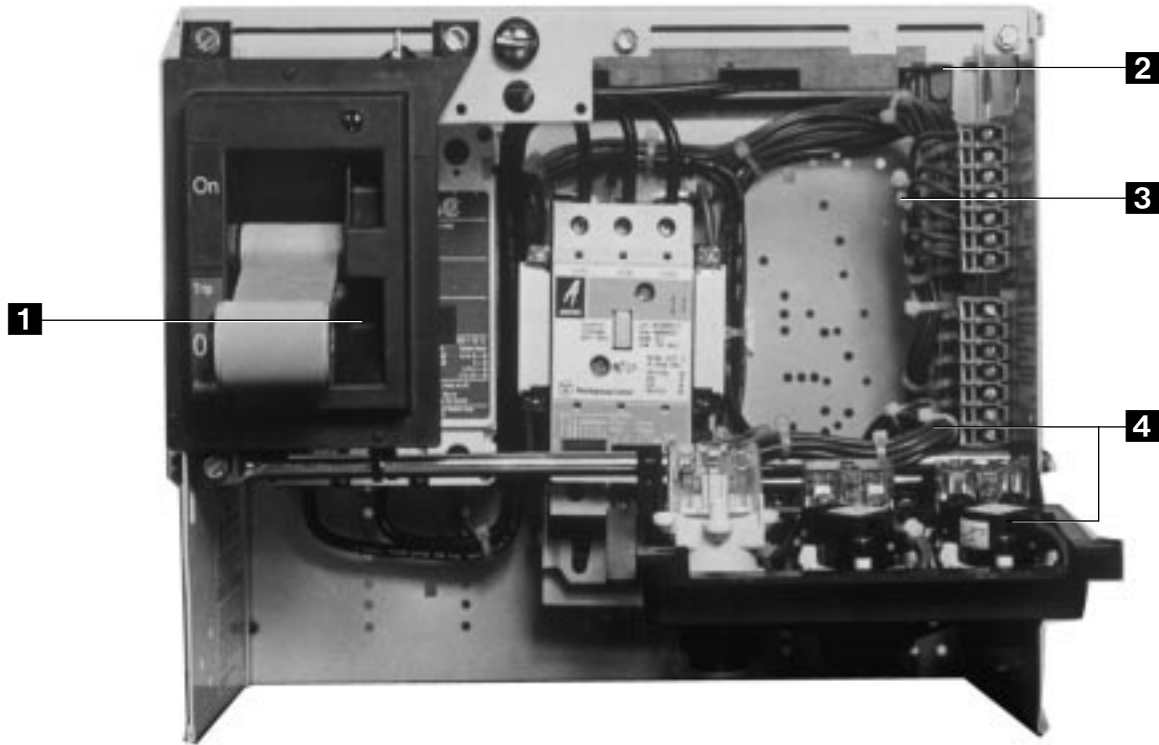

Table 40. Unit Parts

Reference	Description	Page
1	Operating Handle Mechanism Kit	23
2	Unit Drawout Top Rail	24
3	Terminal Blocks	24

Reference	Description	Page
4	Control Transformers Primary/Secondary Fuse Holder Kit Device Panel/Pivot Tube	24 24 24

Operating Handle Mechanism Kit 1

Kit includes operating arm, adjustable linkage and mounting hardware.



Operating Handle Mechanism Kit

Table 41. Operating Handle Mechanism Kit

Description	Style Number
Circuit Breaker Units	
FB/MCP	4719A92G43
KB	4719A92G05
HFD/HMCP	4719A88G01
HMCPE	4700A99G69
HLD	4700A99G65
HJD/HKD	4719A89G01
LB	4719A92G06
MA/MC	4719A92G07
NB	4719A92G08
FCL	4719A92G44
LCL	4719A92G45
HFD/HMCP 6-inch (152.4 mm) Unit	4719A92G56
Fusible Switch Units	
30/60/100A K Switch	5A10098G01
200A K Switch	5A10098G03
400A K Switch	5A10098G05

Advantage Unit Parts

Unit Drawout Top Rail 2



Unit Drawout Top Rail

Table 42. Unit Drawout Top Rail

Description	Style Number
Unit Top Rail with Hardware	4719A92G02

Terminal Blocks 3



Terminal Blocks

Table 43. Terminal Blocks

Description	Style Number
White, 7 Circuit, Pull-apart	4719A92G57

Primary/Secondary Fuse Holder Kit 4

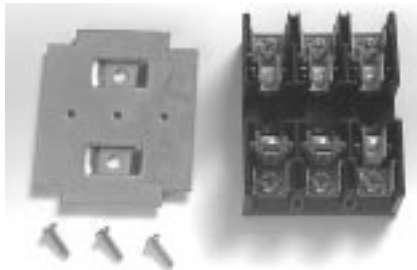

Primary/Secondary Fuse Holder Kit

Table 44. Primary/Secondary Fuse Holder Kit

Description	Style Number
Kit includes fuse block, mounting bracket and screws.	4719A92G59

Control Transformers (480/240V to 120V Single-Phase) 2

Table 45. Control Transformers (480/240V to 120V Single-Phase)

Description	Style Number
50 VA	4719A92G46
100 VA	4719A92G48
150 VA	4719A92G49
200 VA	4719A92G50
250 VA	4719A92G51
300 VA	4719A92G52
350 VA	4719A92G53
500 VA	4719A92G54

Device Panel/Pivot Tube with Mounting Hardware 4



Device Panel/Pivot Tube with Mounting Hardware

Table 46. Device Panel/Pivot Tube with Mounting Hardware

Description	Style Number
Device panel/pivot tube with mounting hardware.	4719A92G03
1 ACM and 2 Pilot Device Knockouts	1161D43H03
1 ACM Knockouts	1161D43H02

K-SW Clip Change Over Information

Fuse Clip Kits are the parts you will need to order to change out the fuse clips on an order.

The kits include clips and hardware for the switch and fuse block. **Refer to VISTA for pricing.**

Table 47. Fuse Clip Kits

Need	Order Kit Number
30 Ampere 600V/R	
30A 250V/R	C351KC21R
30A 600V/J	C351KD71
30A 600V/R	C351KD22-61R
30A Form II	C351KD81
60 Ampere 600V/R	
60A 250V/R	C351KD22-61R
60A 600V/J	C351KD72
60A 600V/R	C351KD62R
60A Form II	C351KD82
100 Ampere 600V/R	
100A 250V/R	C351KE23-63
100A 600V/J	C351KE73
100A 600V/R	C351KE23-63
100A Form II	C351KE83
200 Ampere 600V/R	
200A 250V/R	C351KF24-64
200A 600V/J	C351KF74
200A 600V/R	C351KF24-64
200A Form II	C351KF84

How to Create a Catalog Number

After selecting the circuit device required, create a Dual Mounted feeder unit catalog number based on the following:

Note: Catalog number varies in length based on single or dual mounted unit.

Table 48. Catalog Numbering System Example

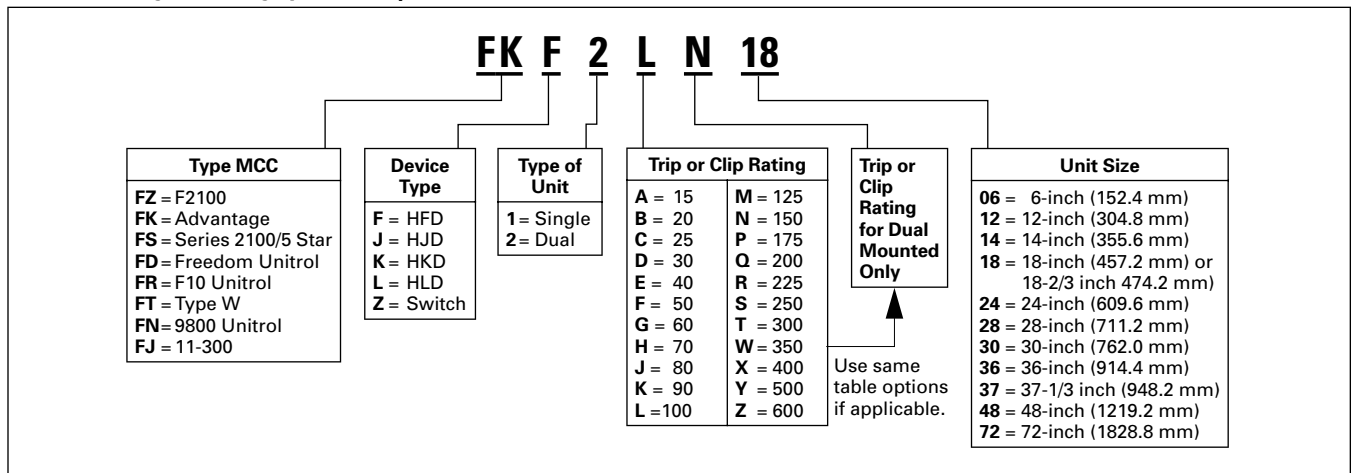

NEMA is the registered trademark and service mark of the National Electrical Manufacturers Association. UL is a registered trademark of Underwriters Laboratories Inc.

Replacement Feeder Units

Product Description

Each Feeder Unit consists of a single mounted 3-pole molded case circuit breaker or fusible switch (dual mounted are also available). Each unit includes a new wrapper, stab assembly, door, handle mechanism and customer specific disconnect device. They are shipped assembled and ready to install into the existing motor control center.

The following are simple steps to select and order a new feeder unit:

Step 1

Select the circuit device required from the **Table 49** below.

Step 2

Verify the amount of space available.

Step 3

Create a catalog number from the formula on **Table 48** on **Page 25**.

Unit options and modifications for replacement feeder units:

For factory installed molded case circuit breaker modifications or additional unit options, contact the factory for prices and availability.

Table 49. Electrical Characteristics and Space Requirements of Molded Case Circuit Breakers and Fusible Switch Replacement Feeder Units — Inches (mm)

Device Type	Maximum Amperes	Interrupting Rating (kAIC)			Trip Rating or Clip	Freedom 2100 Series 2100/5 Star Advantage		Freedom Unitrol		F10		Type W		9800		11-300				
		240V	480V	600V		Single	Dual	Single	Dual ^①	Single	Dual ^①	Single	Dual	Single	Dual ^①	Single	Dual			
HFD	150	100	65	25	15															
					20															
					25															
					30															
					40															
					50															
					60															
					70															
					80	6 ^② (152.4)		6 ^② (152.4)												
					90	12 ^③ (304.8)	12 (304.8)	12 ^③ (304.8)	12 (304.8)	12 ^③ (304.8)	12 (304.8)	12 ^③ (304.8)	12 (304.8)	14 (355.6)	14 (355.6)	14 (355.6)	14 (355.6)			
					100															
					125	12 (304.8)	12 (304.8)	12 (304.8)	18 (457.2)	12 (304.8)	18 (457.2)	12 (304.8)	12 (304.8)	14 (355.6)	18 (457.2)	14 (355.6)	14 (355.6)			
					150	12 ^③ (304.8)						12 ^③ (304.8)								
HJD	250	100	65	25	175															
					200															
					225	18 (457.2)		24 (609.6)		18 (457.2)		18 (457.2)		18 (457.2)		14 (355.6)				
					250															
HKD	400	100	65	35	300															
					350															
					400	24 (609.6)		24 ^④ (609.6)		24 ^④ (609.6)		24 (609.6)		28 ^④ (711.2)		14 (355.6)				
HLD	600	100	65	35	500															
					600	24 (609.6)		24 ^④ (609.6)		24 ^④ (609.6)										
Fusible Switch	30	100	100	100	30	12 (304.8)	12 ^③ (304.8)	12 (304.8)	18 (457.2)	12 (304.8)	18 (457.2)	12 (304.8)	12 ^③ (304.8)	14 (355.6)	18 (457.2)	14 (355.6)	14 (355.6)			
	60	100	100	100	60	12 (304.8)	12 ^③ (304.8)	12 (304.8)	18 (457.2)	18 (457.2)	18 (457.2)	12 (304.8)	12 ^③ (304.8)	14 (355.6)	18 (457.2)	14 (355.6)	14 (355.6)			
	100	100	100	100	100	18 (457.2)		18 (457.2)		18 (457.2)		12 ^③ (304.8)		18 (457.2)		18 (457.2)	18-2/3 (474.2)			
	200	100	100	100	200	36 (914.4)		30 (762.0)		30 (762.0)		24 (609.6)		28 (711.2)		28 (711.2)				
	400	100	100	100	400	36 (914.4)		72 ^④ (1828.8)		48 ^④ (1219.2)		42 (1066.8)		42 ^④ (1066.8)		42 (1066.8)				
	600	100	100	100	600	48 (1219.2)		72 ^④ (1828.8)												

① Combined ampacity no greater than 150A for 12-inch (304.8 mm) height. For greater than 150A, 18-inch (457.2 mm) required.

② 100A maximum.

③ Available in 18-inch (457.2 mm) height.

④ Cable in/cable out, no stab assembly.

This page intentionally left blank.

Eaton Corporation
Cutler-Hammer business unit
1000 Cherrington Parkway
Moon Township, PA 15108-4312
USA
tel: 1-800-525-2000
www.cutler-hammer.eaton.com