

Residential and light commercial distribution products



EATON

Powering Business Worldwide

Residential and light commercial products

Contents

Description	Page
Type BR Main Breaker plug-in loadcentres	5
Combination (main circuit breaker) single-phase Type 1	6
Combination (main circuit breaker) single-phase Type 3R	7
Combination (main circuit breaker) three-phase Type 1	8
Combination (main circuit breaker) three-phase Type 3R	9
Type BR Main Lug plug-in loadcentres	5
Non-combination (main lug only) single-phase Type 1	10
Non-combination (main lug only) single-phase Type 3R	11
Non-combination (main lug only) three-phase Type 1	12
Non-combination (main lug only) three-phase Type 3R	13
Non-combination (main lug only) 70 A single-phase	14
Type BR plug-in loadcentre Accessories	15
Plug-in circuit breakers for CPM/CPL/CBRPM/CBRPL	16
Type BR, DNPL, GFTCB, GFEP and GFXB	16
Type BR single- and multi-pole	17
Type DNPL Duplex, Independent Quadplex and circuit breaker packs	18
Type BR arc fault circuit interrupter	19
Types GFCB and GFEP ground fault	20
Type BR internationally rated	22
Types GFXB internationally rated ground fault and Type BR moulded case switches	22
Plug-in loadcentre main circuit breakers for BR	23
Types CSR and CC	23
Plug-in circuit breaker accessories for BR loadcentres	24
Plug-in OEM loadcentre interior assemblies	25
Type CH plug-in loadcentres	29
Combination and non-combination single-phase	31
Plug-in circuit breakers for CH	31
Type CH single-, multi-pole and twin	31
Type CHP commercial	32
Type CHP arc fault circuit interrupter	33
Type CHP ground fault	34
Plug-in loadcentre main circuit breakers for CH	35
Type CSR	35
Plug-in loadcentres and circuit breaker accessories for CH	36
Type CH accessories	36

Residential and light commercial products

Contents (continued)

Description	Page
Type CBM/CBL bolt-on loadcentres	37
Combination (main circuit breakers) single- and three-phase aluminum bus	37
Combination (main circuit breakers) single- and three-phase copper bus	38
Non-combination (main lug only) single- and three-phase aluminum bus	39
Non-combination (main lug only) single- and three-phase copper bus	40
Bolt-on circuit breakers for CBM/CBL	41
Type BAB and QBHW single- and multi-pole	41
Type QBA arc fault circuit interrupter and DNBA duplex	42
Type QBGF and QBGFEP ground fault	43
Bolt-on loadcentre and circuit breaker accessories	44
Manual transfer switches/generator panels	45
Spa panels	47
Surge suppression products	49
Stage 1 and Stage 1 Type 2	48
Accessories	49
Street lighting panels	50
In-pole	50
Pedestal	52
Combined loadcentre and meter socket	52
Metered temporary ground fault power panel	53
Mini-power centres	54
Plug-in mini-power centres	55
Plug-in	55
Bolt-on mini-power centres	56
Bolt-on	56
Residential fuse panel inserts	57
Insert interiors	58
Trims	59
Replacement classic circuit breakers	61
Bolt-on Type BQL single-, multi-pole, Duplex and Quadplex	60
Bolt-on Type BQL ground fault and moulded case switches	62
Bolt-on Type QBH single- and multi-pole	62
Plug-in Type BJ two- and three-pole	63
Pressure switches	64
Index	65

Type BR plug-in main breaker loadcentres

Product description

Loadcentres feature factory installed main lugs or main breakers. The BR interiors are manufactured of formed, plated aluminum. Eaton also supplies a full line of Eaton brand BR, DNPL, GFTCB and GFEP type branch circuit breakers and accessories for these loadcentres.

Product application

Designed for the protection and distribution of single and multi-dwelling residential and light commercial loads to 120/240 volts AC, such as lighting, heating, appliance and small motor branch circuits.

All main breaker combination loadcentres are CSA listed for use as service entrance equipment.

Ratings

Single-phase, three-wire, 120/240 volts AC and three-phase, four-wire, 120/208 volts AC. Mains through 400 A. Available with up to 84 branch circuits. Main breakers on 150 and 200 A panels are rated at 25,000 AIC.

Metal enclosure specifications

Enclosures are made of 16 gauge sheet steel, either galvanized or epoxy painted. These coatings provide superior corrosion protection. All trims used on BR loadcentres are chromate sealed and finished with an electro-disposition epoxy paint in grey (ANSI-61) or white, which exceeds requirements for outdoor and indoor applications. A combination surface/flush cover with integral door is supplied with indoor loadcentres rated from 100 through 400 A.

All plug-in loadcentres are CSA listed to file LL98266. CSA certified to C22.2 No.29.

Warranty

10 year limited.

Type BR loadcentre features and benefits:

Optimized knockout locations for additional access.

Easier to remove.

White box trim and barriers provide more professional look and feel.

Smooth case edges.

2/0 lug is easily removeable and can be installed in any location on the neutral bar.

Inboard neutral increases gutter space to allow for professional installation of conductors.

BR short-body configuration maximizes gutter space providing ease of installation of conductors.

Reduced clutter of pigtailed provides a clean gutter space.

Quicker and neater installation, along with a consistent form and fit.

Extra ground positions provided in panels with more than 20 circuits allows quicker and easier wiring.

Self-levelling tabs allow for quick drywall offset.

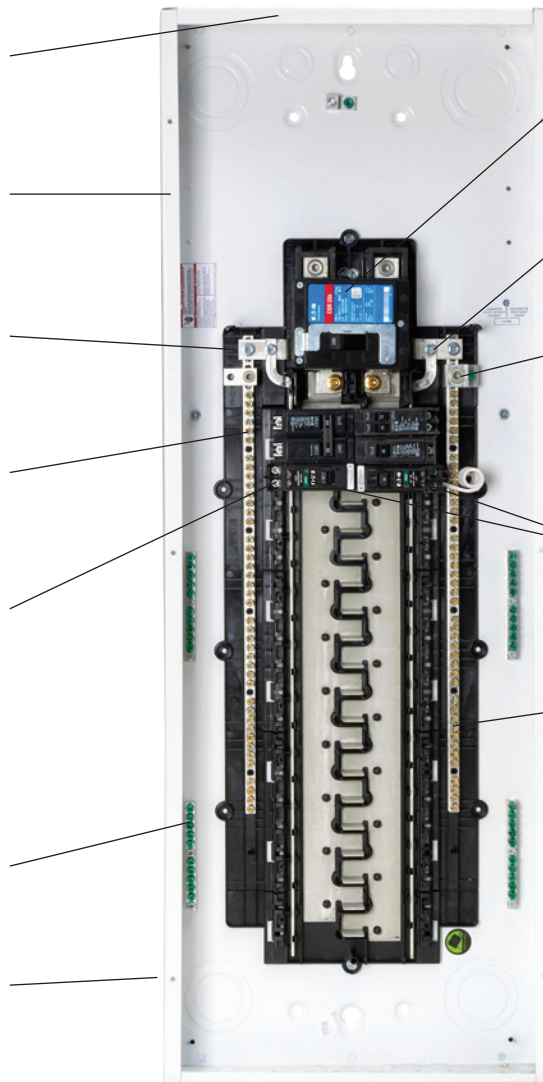

Commercial grade 25 kAIC series rated main breaker with lock-off bracket for superior protection.

Common screws minimize the number of tools required for installation. Neutral bar, ground bar, and BR breaker screws share a common drive type.

Bonding screw provides a quick and easy means of bonding the ground and neutral.

Plug-on neutral (PON) eliminates the pigtail connection providing time and labour savings for a professional installation.

Backed out neutral and ground screws allow for quick connection of neutral and ground conductors.

Cover features include:

Improved twist-outs that are easier to remove

Durable embossed circuit numbering with added marking for twin breakers

Keyhole hanging feature allows for easier cover installation

Type BR plug-in main breaker loadcentres

Combination (main circuit breaker) single-phase Type 1

Three-wire, 120/240 Vac combination service entrance Type 1 (indoor)

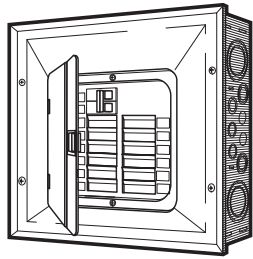

CBRPM112

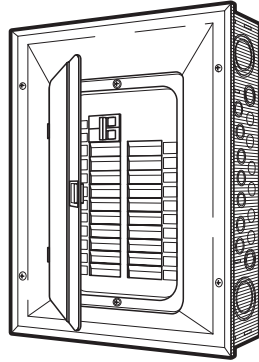

CBRPM120

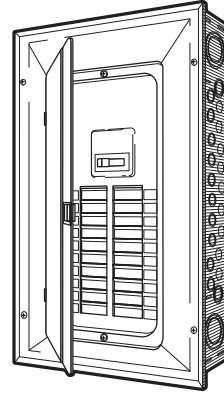

CBRPM1520

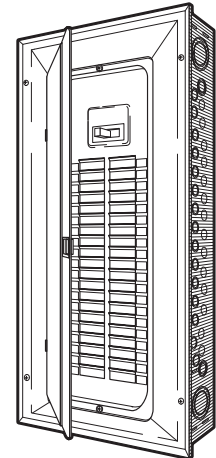

CBRPM240

Product selection

Table 1a. Main circuit breaker indoor Type 1 BR plug-on neutral loadcentres

Maximum ampere rating	Main breaker rating	Catalogue number	Max. no. 1-inch spaces	Max. no. 1/2-inch spaces	Cover style	Type of main breaker	Dimensions (inches)			Wire size range for main CU/AL
							H	W	D	
125	100	CBRPM112	12	24	Flush/surface	BRH a	18-3/4	14-3/8	3-7/8	#8-1/0
125	100	CBRPM116	16	32	Flush/surface	BRH a	21	14-3/8	3-7/8	#8-1/0
125	125	CBRPM116Z	16	32	Flush/surface	BRH b	21	14-3/8	3-7/8	#4-2/0
125	100	CBRPM120	20	40	Flush/surface	BRH a	27	14-3/8	3-7/8	#8-1/0
125	100	CBRPM130	30	60	Flush/surface	BRH a	29-1/8	14-3/8	3-7/8	#8-1/0
125	125	CBRPM130Z	30	60	Flush/surface	BRH b	29-1/8	14-3/8	3-7/8	#4-2/0
125	100	CBRPM140	40	80	Flush/surface	BRH a	34-1/8	14-3/8	3-7/8	#8-1/0
125	125	CBRPM140Z	40	80	Flush/surface	BRH b	34-1/8	14-3/8	3-7/8	#4-2/0
150	150	CBRPM1520	20	40	Flush/surface	CSR c	29-1/8	14-3/8	3-7/8	#2-300 MCM
150	150	CBRPM1530	30	60	Flush/surface	CSR c	34-1/8	14-3/8	3-7/8	#2-300 MCM
150	150	CBRPM1540	40	80	Flush/surface	CSR c	39	14-3/8	3-7/8	#2-300 MCM
200	200	CBRPM216	16	32	Flush/surface	CSR c	29-1/8	14-3/8	3-7/8	#2-300 MCM
200	200	CBRPM220	20	40	Flush/surface	CSR c	29-1/8	14-3/8	3-7/8	#2-300 MCM
200	200	CBRPM230	30	60	Flush/surface	CSR c	34-1/8	14-3/8	3-7/8	#2-300 MCM
200	200	CBRPM240	40	80	Flush/surface	CSR c	39	14-3/8	3-7/8	#2-300 MCM
200	200	CBRPM260	60	120	Flush/surface	CSR c	49	14-3/8	3-7/8	#2-300 MCM

Table 1b. Main circuit breaker indoor Type 1 BR non plug-on neutral loadcentres

Maximum ampere rating	Main breaker rating	Catalogue number	Max. no. 1-inch spaces	Max. no. 1/2-inch spaces	Cover style	Type of main breaker	Dimensions (inches)			Wire size range for main CU/AL
							H	W	D	
400	300	CPM342	42	84	Flush/surface	DK d	66-1/2	16-1/8	6-5/16	(2)#2/0-250 MCM or (1)#2/0-500 MCM f
400	400	CPM442	42	42 f	Flush/surface	DK d	66-1/2	16-1/8	6-5/16	(2)#2/0-250 MCM or (1)#2/0-500 MCM f

a High Interrupting 22 kAIC BRH breakers

b 22 kAIC BRH2125 main breaker is factory installed.

c Factory installed 25 kAIC main breaker.

d DK breaker is a 65 kAIC, factory-sealed breaker.

e Restricted due to available neutrals, extra neutrals are available on **page 15 table 10b** which will expand available circuitry to a maximum of 84 circuits.

f 3TA401K must be ordered separately for #2/0-500-MCM.

Type BR plug-in main breaker loadcentres

Combination (main circuit breaker) single-phase Type 3R

Three-wire 120/240 Vac combination service entrance Type 3R (outdoor/raintight) ^a

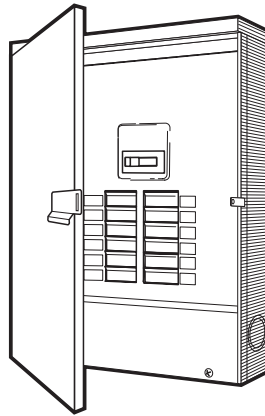

RCPM220

Table 2. Main circuit breaker outdoor/raintight Type 3R loadcentres ^a

Maximum ampere rating	Main breaker rating	Catalogue number	Max. no. 1-inch spaces	Max. no. 1/2-inch spaces	Cover style	Type of main breaker	Dimensions (inches)			Wire size range for main Cu/Al
							H	W	D	
125	100	RCPM112 ^b	12	24	Outdoor	BR ^{cd}	18-1/2	14-3/8	5	#8-1/0
125	100	RCPM120 ^b	20	40	Outdoor	BR ^{cd}	25	14-3/8	5	#8-1/0
125	100	RCPM130 ^b	30	60	Outdoor	BR ^{cd}	28-7/8	14-3/8	5	#8-1/0
150	150	RCPM1530 ^b	30	60	Outdoor	CSR ^e	33-7/8	14-3/8	5	#2-300 MCM
200	200	RCPM220 ^b	20	40	Outdoor	CSR ^e	28-7/8	14-3/8	5	#2-300 MCM
200	200	RCPM230 ^b	30	60	Outdoor	CSR ^e	33-7/8	14-3/8	5	#2-300 MCM
200	200	RCPM240 ^b	40	80	Outdoor	CSR ^e	38-3/4	14-3/8	5	#2-300 MCM

^a Outdoor loadcentres accommodate Type DS conduit hubs. Hubs not included. See **page 15 table 10b** for selection.

^b All enclosures include a locking hasp as an integral part of the door latching mechanism.

^c Type BR—100 A 10 kAIC main circuit breaker is factory installed (BR2100).

^d High interrupting BRH breakers are available on **page 17**.

^e Factory installed 25 kAIC main breaker.

Type BR plug-in main breaker loadcentres

Combination (main circuit breaker) three-phase Type 1

Four-wire 120/208 Vac combination service entrance Type 1 (indoor)

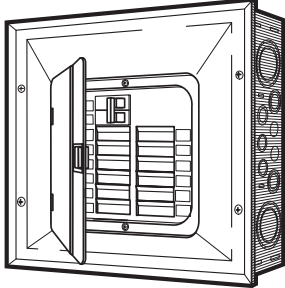

3CPM112

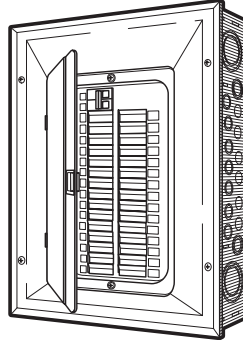

3CPM130

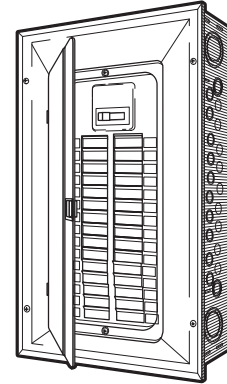

3CPM230

Table 3. Main circuit breaker indoor Type 1 loadcentres

Maximum ampere rating	Main breaker rating	Catalogue number	Max. no. 1-inch spaces	Max. no. 1/2-inch spaces	Cover style	Type of main breaker	Dimensions (inches)			Wire size range for main Cu/Al
							H	W	D	
125	100	3CPM112	12	24	Flush/surface	BR ^{b,c}	21	14-3/8	3-3/4	#4-1/0
125	100	3CPM130	30	60	Flush/surface	CC ^d	39	14-3/8	3-3/4	#4-4/0
200	200	3CPM230	30	60	Flush/surface	CC ^d	39	14-3/8	3-3/4	#1-250 MCM
400	400	3CPM442 ^a	42	42 ^a	Flush/surface	DK ^e	66-1/2	16-1/8	6-5/16	(2) 2/0-250 MCM (1) 2/0-500 MCM ^f

^a Extra neutrals which will expand available circuitry to a maximum of 84 circuits are available on **page 15**.

^b Type BR—100 A 10 kAIC main circuit breaker is factory installed (BR3100).

^c High interrupting BRH breakers are available on **page 17**.

^d Factory installed 10 kAIC main breaker.

^e DK Breaker is a 65 kAIC factory-sealed main breaker.

^f Circuit breaker lug kit 3TA401 must be ordered separately to accept #2/0-500 MCM cabling.

Type BR plug-in main breaker loadcentres

Combination (main circuit breaker) three-phase Type 3R

Four-wire 120/208 Vac combination service entrance Type 3R (outdoor/raintight) ^{ab}

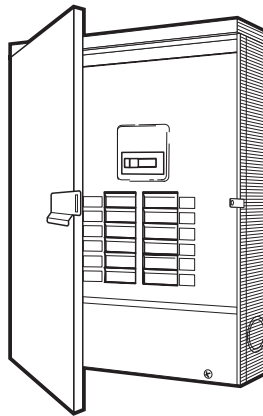

R3CPM230

Table 4. Main circuit breaker outdoor/raintight Type 3R loadcentres ^{ab}

Maximum ampere rating	Main breaker rating	Catalogue number	Max. no. 1-inch spaces	Max. no. 1/2-inch spaces	Cover style	Type of main breaker	Dimensions (in)			Wire size range for main Cu/Al
							H	W	D	
100	100	R3CPM112 ^b	12	24	Outdoor	BR ^{cd}	20-3/4	14-3/8	5	#4-1/0
125	100	R3CPM130 ^b	30	60	Outdoor	CC ^e	38-3/4	14-3/8	5	#4-4/0
200	200	R3CPM230 ^b	30	60	Outdoor	CC ^e	38-3/4	14-3/8	5	#1-250 MCM

^a Outdoor loadcentres accommodate Type DS conduit hubs. Hubs not included. See **page 15** for selection.

^b All enclosures include a locking hasp as an integral part of the door latching mechanism.

^c Type BR—100 A 10 kAIC main circuit breaker is factory installed (BR3100).

^d High interrupting BRH breakers are available on **page 17**.

^e Factory installed 10 kAIC main breaker.

Type BR plug-in main lug loadcentres

Non-combination (main lug only) single-phase Type 1

Three-wire 120/240 Vac non-combination Type 1 (indoor)

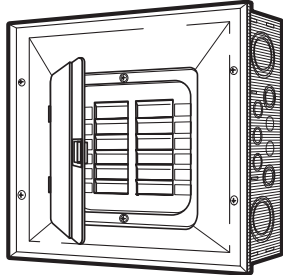

CBRPL112

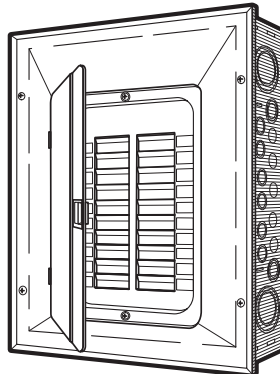

CBRPL220

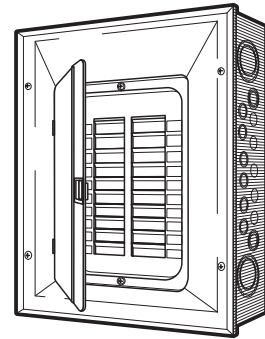

CBRPL120

Product selection

Table 5a. Main lug only indoor Type 1 loadcentres

Maximum Ampere Rating	Catalogue Number	Max. no. 1-inch spaces	Max. no. 1/2-inch spaces	Cover style	Dimensions (inches)			Wire size range for main Cu/Al
					H	W	D	
125	CBRPL112	12	24	Flush/surface	16-3/4	14-3/8	3-7/8	#14-2/0
125	CBRPL116	16	32	Flush/surface	18-3/4	14-3/8	3-7/8	#14-2/0
125	CBRPL120	20	40	Flush/surface	21	14-3/8	3-7/8	#14-2/0
125	CBRPL130	30	60	Flush/surface	29-1/8	14-3/8	3-7/8	#14-2/0
200	CBRPL220	20	40	Flush/surface	27	14-3/8	3-7/8	#1-300 MCM
200	CBRPL240	40	80	Flush/surface	34-1/8	14-3/8	3-7/8	#1-300 MCM

Table 5b. Main lug only indoor Type 1 non plug-in loadcentres

Maximum Ampere Rating	Catalogue Number	Max. no. 1-inch spaces	Max. no. 1/2-inch spaces	Cover style	Dimensions (inches)			Wire size range for main Cu/Al
					H	W	D	
100	CCPL102	2 ^a	4	Surface	11-1/2	6-3/4	3-1/4	#14-1/0
125	CCPL104	4	8	Flush/surface	13	11	3-1/2	#14-2/0
125	CCPL108	8	16	Flush/surface	13	11	3-1/2	#14-2/0
400	CPL442	42	42 ^b	Flush/surface	54	16-1/8	6-5/16	(1) 250-750 MCM (2) 3/0-250 MCM

^a Service equipment approved when used with two-pole BR type breaker.

^b Extra neutrals which will expand available circuitry to a maximum of 84 circuits are available on [page 15](#)

Type BR plug-in main lug loadcentres

Non-combination (main lug only) single-phase Type 3R

Three-Wire 120/240 Vac non-combination Type 3R (outdoor/raintight) ^a

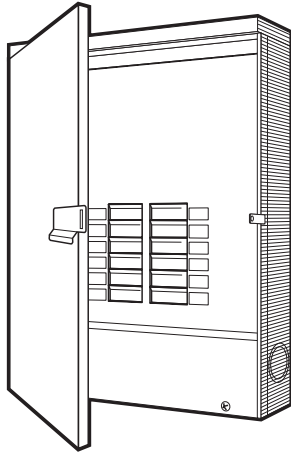

RCPL112

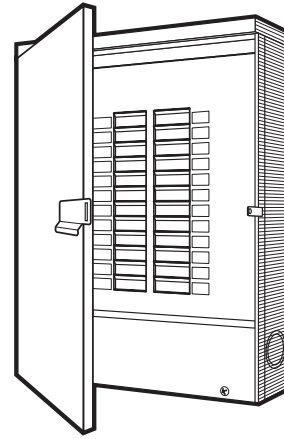

RCPL220

Table 6. Main lug only outdoor/raintight Type 3R loadcentres ^a

Maximum ampere rating	Catalogue number	Max. no. 1-inch spaces	Max. no. 1/2-inch spaces	Cover Style	Dimensions (inches)			Wire size range for main Cu/Al
					H	W	D	
125	RCCPL102 ^b	2 ^c	4	Outdoor	11-1/2	6-1/2	4	#14-2/0
125	RCCPL104 ^b	4	8	Outdoor	13	11	3-1/2	#14-2/0
125	RCCPL108 ^b	8	16	Outdoor	13	11	3-1/2	#14-2/0
125	RCPL112 ^b	12	24	Outdoor	16-1/2	14-3/8	5	#14-2/0
125	RCPL120 ^b	20	40	Outdoor	20-3/4	14-3/8	5	#14-2/0
125	RCPL130 ^b	30	60	Outdoor	28-7/8	14-3/8	5	#14-2/0
200	RCPL220 ^b	20	40	Outdoor	25	14-3/8	5	#1-300 MCM
200	RCPL240 ^b	40	80	Outdoor	33-7/8	14-3/8	5	#1-250 MCM

^a Outdoor loadcentres accommodate Type DS conduit hubs. Hubs not included. See **page 15** for selection.

^b All enclosures include a locking hasp as an integral part of the door latching mechanism.

^c Service equipment approved when used with two-pole BR type breaker.

Type BR plug-in main lug loadcentres

Non-combination (main lug only) three-phase Type 1

Four-wire 120/208 Vac non-combination Type 1 (indoor)

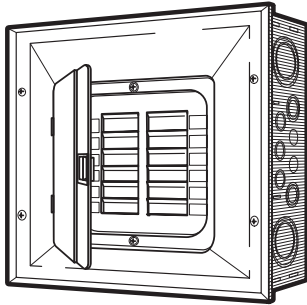

3CPL112

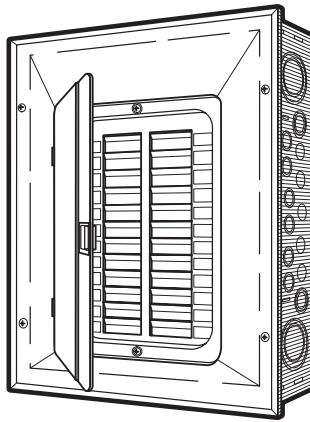

3CPL224

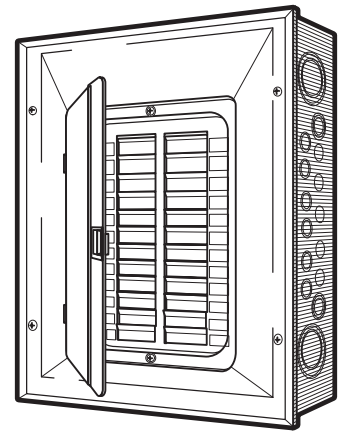

3CPL124

Table 7. Main lug only indoor Type 1 loadcentres

Maximum ampere rating	Catalogue number	Max. no. 1-inch spaces	Max. no. 1/2-inch spaces	Cover style	Dimensions (inches)			Wire size range for main Cu/Al
					H	W	D	
100	3CCPL103	3 ^a	6	Surface	14-1/4	6-1/2	3-1/4	#14-2/0
125	3CPL112	12	24	Flush/surface	21	14-3/8	3-7/8	#8-2/0
125	3CPL124	24	48	Flush/surface	29	14-3/8	3-7/8	#8-2/0
125	3CPL130	30	60	Flush/surface	34.12	14-3/8	3-7/8	#8-2/0
125	3CPL136	36	72	Flush/surface	39	14-3/8	3-7/8	#8-2/0
200	3CPL218	18	36	Flush/surface	27	14-3/8	3-7/8	#2-300 MCM
200	3CPL224	24	48	Flush/surface	34.12	14-3/8	3-7/8	#2-300 MCM
200	3CPL230	30	60	Flush/surface	34.12	14-3/8	3-7/8	#2-300 MCM
200	3CPL242	42	84	Flush/surface	39	14-3/8	3-7/8	#2-300 MCM
400	3CPL442	42	42 ^b	Flush/surface	54	16-3/8	6-5/16	(1) 250-750 MCM (2) 3/0-250 MCM

^a Suitable for use as service equipment when used with three-pole BR type breaker.

^b Extra neutrals which will expand available circuitry to a maximum of 84 circuits are available on [page 15](#).

Non-combination (main lug only) three-phase Type 3R

Four-wire 120/208 Vac non-combination Type 3R (outdoor/raintight) ^a

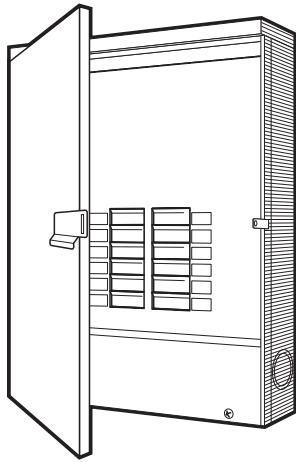

R3CPL112

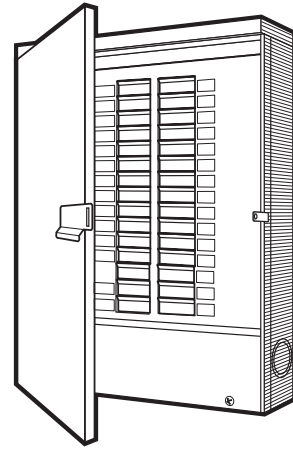

R3CPL230

Table 8. Main lug only outdoor/raintight Type 3R Loadcentres ^a

Maximum ampere rating	Catalogue number	Max. no. 1-inch spaces	Max. no. 1/2-inch spaces	Cover style	Dimensions (inches)			Wire size range for main Cu/Al
					H	W	D	
100	R3CCPL103 ^b	3 ^c	—	Outdoor	11-1/2	6-1/2	4	#14-2/0
125	R3CPL112 ^b	12	24	Outdoor	20-3/4	14-3/8	5	#14-2/0
125	R3CPL130 ^b	30	60	Outdoor	38-3/4	14-3/8	5	#14-2/0
125	R3CPL136 ^b	36	72	Outdoor	38-3/4	14-3/8	5	#14-2/0
200	R3CPL230 ^b	30	60	Outdoor	33-7/8	14-3/8	5	#2-300 MCM
200	R3CPL242 ^b	42	42 ^d	Outdoor	38-3/4	14-3/8	5	#2-300 MCM

^a Outdoor loadcentres accommodate Type DS conduit hubs. Hubs not included. See **page 15** for selection.

^b All enclosures include a locking hasp as an integral part of the door latching mechanism.

^c Suitable for use as service equipment when used with three-pole BR type breaker.

^d Extra neutrals to expand available circuitry to a maximum of 84 circuits are available on **page 15**.

Type BR plug-in main lug loadcentres

Non-combination (main lug only) 70 A single-phase

Three-wire 250 Vac maximum non-combination

Service entrance approved when used with two-pole BR or BRH breakers. ^a

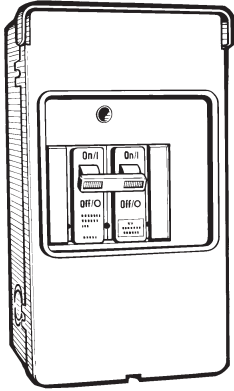

CPL072 indoor



CPL072R ^c outdoor



CPL072FGP flush



CPL072SGP surface



CPL072RGP ^{cd} outdoor

Table 9. 70 A main lug only polymeric and metallic loadcentres

Maximum ampere rating	Enclosure style	Material	Catalogue number	Max. no. 1-inch spaces	Max. no. 1/2-inch spaces	Dimensions (inches)			Wire size range for main Cu/Al
						H	W	D	
70	Indoor Type 1 ^b	Polymeric	CPL072	2	4	8-5/8	5	3-1/4	#14-2
70	Indoor/outdoor Type 3R ^b	Polymeric	CPL072R ^c	2	4	8-11/16	6-1/4	4-5/16	#14-2
70	Indoor Type 1 flush mount ^b	Metallic	CPL072FGP	2	4	9-7/16	4-1/2	3	#14-2
70	Indoor Type 1 surface mount ^b	Metallic	CPL072SGP	2	4	9-7/16	4-1/2	3	#14-2
70	Indoor/outdoor Type 3R ^b	Metallic	CPL072RGP ^{cd}	2	4	9-7/16	4-1/2	3	#14-2

^a BR and BRH two-pole breakers can be found on **page 17**.

^b Service entrance approved when used with two-pole BR/BRH breakers.

^c The circuit breaker protective cover incorporates a locking hasp.

^d Uses DS*H1 style hubs found on **page 15**.

Table 10a. Type BR Plug-on Neutral (PON) loadcenter CBRPM/CBRPL accessories

Description	Catalogue number
White cover replacement latch—indoor loadcenters	LATCHPW
Grey cover replacement latch—indoor loadcenters	LATCHPG
Retaining bracket for backfed main breaker—BR	BRPHD
Hold down screw for 2 pole type BJ in BR PON loadcentre	BRPHDBJ
Incoming 2/0 neutral lug	NLP20
Incoming 300 kcmil neutral lug	NLP300
BR loadcenter panel directory label 0-30 circuits ^a	LCPD30
BR loadcenter panel directory label 0-40 circuits ^a	LCPD40
BR loadcenter panel directory label 31-60 circuits ^a	LCPD60

Description	Catalogue number
Bonding kit for bonding the neutral bus to the loadcenter	BONDKITP
5 terminal ground bar kit	GBKP5
10 terminal ground bar kit	GBKP10
14 terminal ground bar kit	GBKP14
21 terminal ground bar kit	GBKP21
225A/2P subfeed lug block - #2-300KCMIL	BRPSF225
(1) 42 cct panel label, (6) white panel cover screws, (3) filler plates, (1) Eaton arc flash label, (1) neutral or ground lug	BRPNLKIT

Table 10b. Legacy Plug-in loadcenter CPM/CPL accessories

Description	Catalogue number
Number strips for CPL/CPM 42 circuits ^a	NSP42
Circuit identification labels (e.g. hot water heater) ^b	BP3110C
Ground bar kit 5 position	GBK5
Ground bar kit 8 position	GBK8
Ground bar kit 10 position	GBK10
Ground bar kit 14 position	GBK14
Ground bar kit 21 position	GBK21
Subfeed kit for 125 A loadcentres #8–2/0 ^g	BRSF125
Subfeed kit for 150 A three-phase loadcentres #8–2/0 ^g	3BRSF150
Subfeed kit for 225 A loadcentres #2–300 MCM ^g	BRS225
Subfeed kit for 225 A three-phase loadcentres #2–300 MCM ^g	3BRS225
Subfeed kit for 400 A loadcentres #8–300 MCM ^g	BRS400
Subfeed kit for 400 A three-phase loadcentres ^g	3BRS400
Neutral/ground lug kit for 2/0 ^h	NL20
Neutral/ground lug kit for 3/0 ^h	NL30
Neutral/ground lug kit for 300 MCM (maximum) ^h	NL300
Neutral kit for 400 A combination loadcentres ⁱ	CPM400KIT
Neutral kit for 400 A non-combination loadcentres ^j	CPL400KIT
White plastic replacement door latch	52-3125-6
White spray can touch up paint	SPCWH

Description	Catalogue number
Door lock for 4–8 circuit 125 A (CPM/CPL)	CH9FL ^k
Door lock for 12–42 circuit 100–225 A and 400 A (CPM/CPL)	TDL ^k
Isolated ground kit	ISGRD
Trim screw kit (CPM/CPL) ^d	CVRSCRW
Trim screw kit white (order in quantities of 25)	LCCSW
3/4-inch hub for 100–125 A Type 3R loadcentres (3 x 2-3/4 inches) ^e	DS075H1
1-inch hub for 100–125 A Type 3R loadcentres (3 x 2-3/4 inches) ^e	DS100H1
1-1/4 inch hub for 100–125 A Type 3R loadcentres (3 x 2-3/4 inches) ^e	DS125H1
1-1/2 inch hub for 100–125 A Type 3R loadcentres (3 x 2-3/4 inches) ^e	DS150H1
2-inch hub for 100–125 A Type 3R loadcentres (3 x 2-3/4 inches) ^e	DS200H1
2-inch hub for 150 and 200 A Type 3R loadcentres (4-3/4 x 4-5/8 inches)	DS200H2
2-1/2 inch hub for 150 and 200 A Type 3R loadcentres (4-3/4 x 4-5/8 inches)	DS250H2
3-inch hub for 150 and 200 A Type 3R loadcentres (4-3/4 x 4-5/8 inches)	DS300H2
3/4-inch hub for R3CCPL103 loadcentres (2-1/8 x 3-1/4 inches)	RH75P
1-inch hub for R3CCPL103 loadcentres (2-1/8 x 3-1/4 inches)	RH100P
1-1/4 inch hub for R3CCPL103 loadcentres (2-1/8 x 3-1/4 inches) RH125P	RH125P
1-inch filler plate kit ^f	BRFP
Grey plastic replacement door latch	52-3125-5
Grey spray can touch up paint	SPC61

^a 25 per package. Catalogue number represents one package.

^b 50 per package. Catalogue number represents one package.

^c Includes outer trim only, no door, and no deadfront.

^d 100 per package. Catalogue number represents one package.

^e Except R3CCPL103.

^f Kit includes 25 pieces.

^g Line/Load terminals supplied only. Neutral conductor must be purchased separately. See above listed kits.

^h Neutral bolts to main neutral bar i.e. remove screw and install lug kit.

ⁱ Kit includes 2 neutral bars.

^j Kit includes 1 neutral bar.

^k Comes with a set of keys.

Plug-in circuit breakers for CPM/CPL/BRPM/BRPL

Type BR, DNPL, GFTCB, GFEP, and GFXB

BR circuit breakers

Eaton Type BR plug-in breakers in the standard 1-inch per pole moulded case and can be used as main and/or branch disconnect devices. All are CSA and UL listed. Typical ampacity range for BR breakers is 15 through 125 A.

FIRE-GUARD arc fault circuit interrupter (AFCI)

The FIRE-GUARD arc fault circuit interrupter (AFCI) is a residential circuit breaker with an integrated processor which recognizes the unique current and/or voltage signatures associated with arcing faults, and acts to interrupt the circuit to reduce the likelihood of an electrical fire. With the Eaton Fire-Guard AFCI, protection from arcing faults is combined with conventional thermal and magnetic overloads as found in standard residential circuit breakers protecting wiring from excessive heat or damage due to overloading or short circuits. Fire-Guard AFCI can also be equipped with 5 mA ground fault protection to protect from personal shock hazards. Now, there is a residential circuit breaker that provides protection from arcing faults, conductor damage due to thermal overloads and short circuits, as well as 5 mA ground fault protection in one integrated design.

GFTCB people protection breakers

Eaton Type GFCB (ground fault circuit breaker) combines state-of-the-art electronic technology with a circuit breaker mechanism in a compact 1-inch per pole moulded case. The GFCB automatically

senses hot wire-to-ground faults in a 4 to 6 mA range and shuts off the power thus providing an extra margin of safety beyond that of conventional circuit breakers. GFCB applications include bathrooms, basement outlets, swimming pools, outdoor branch circuits and kitchen branch circuits. Self testing compliant to new codes. Type GFCB breakers are also available in 30 mA equipment protectors. 30 mA breakers are for equipment requiring a higher interrupting value such as heat tracing.

DNPL twin circuit breakers

DNPL plug-in breakers have the same construction as Eaton Type BR 1-inch per pole devices except that two single-pole circuits are provided in a 1-inch space. CSA listed interrupting rating is 10,000 AIC. All ratings are CSA and UL listed.

DNPL quad circuit breakers

Quadplex construction of Eaton Type DNPL plug-in breakers provides various combinations of two-pole and single-pole devices in a 2-inch moulded case. All plug-in breakers are approved for HACR applications.

- All ratings are CSA and UL listed
- CSA certified to C22.2 No. 5, file LR3300
- All loadcentre breakers are GOS listed for conformity

① Single-pole 15 and 20 A units are switching duty (SWD) rated.

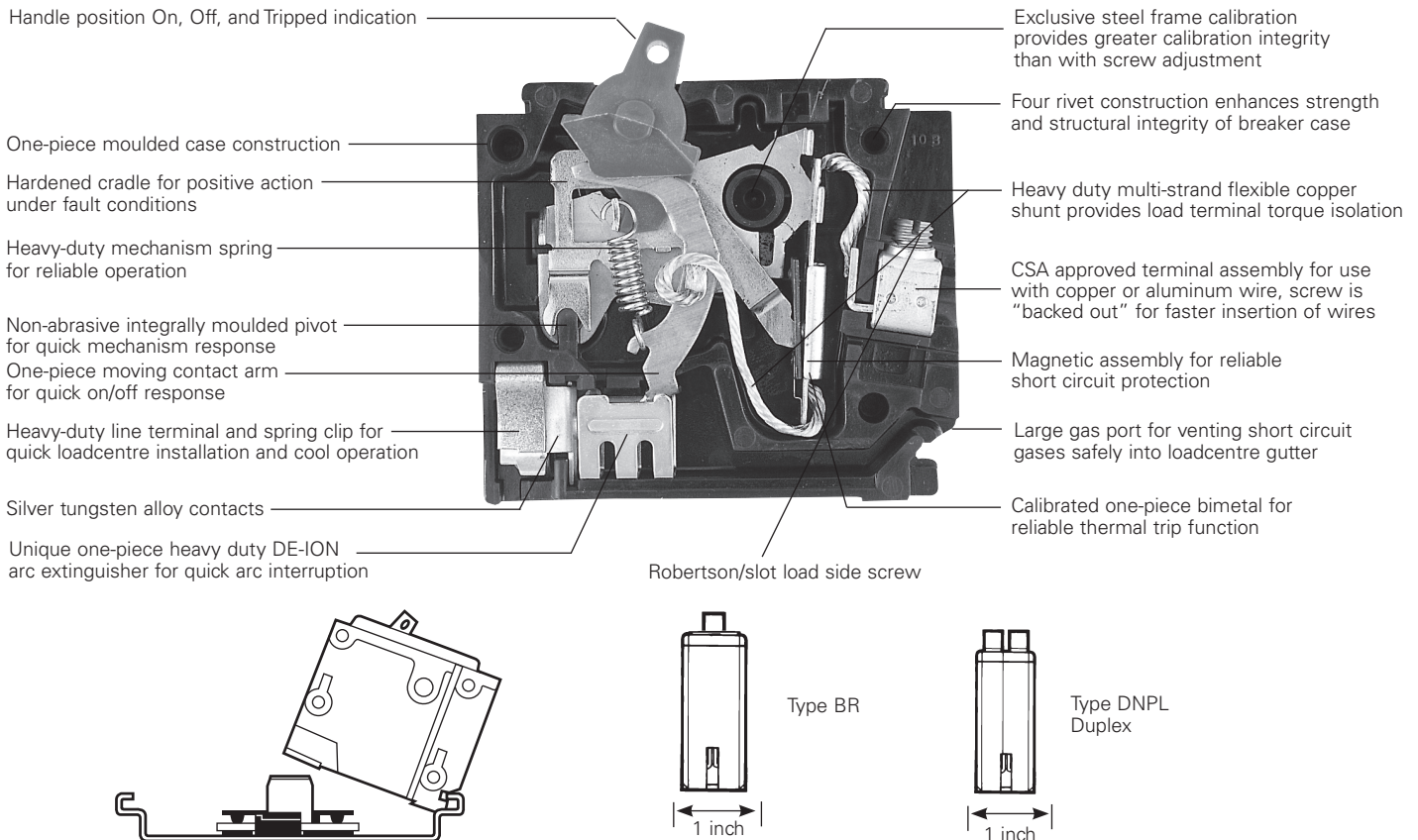

Type BR single- and multi-pole

Type BR ^{ab}

- 10,000/22,000 A interrupting capacity at 120 Vac, 120/240 Vac, and 240 Vac
- Two- and three-pole versions feature a common trip



BR120



BR215



BR320

Table 11. Single- and multi-pole plug-in circuit breakers

Ampere rating	Wire size range (Cu/Al 60 °C or 75 °C)	Catalogue numbers					
		Single-pole, 120/240 Vac 10 per shelf carton		Two-pole, 120/240 Vac 5 per shelf carton		Three-pole, 120/240 Vac 5 per shelf carton	
		10 kAIC	22 kAIC	10 kAIC	22 kAIC	10 kAIC	22 kAIC
15	#14-4	BR115 ^{cd}	BRH115	BR215	BRH215	BR315	BRH315
20	#14-4	BR120 ^{cd}	BRH120	BR220	BRH220	BR320	BRH320
25	#14-4	BR125 ^c	BRH125	BR225	BRH225	BR325	BRH325
30	#14-4	BR130 ^c	BRH130	BR230	BRH230	BR330	BRH330
35	#14-4	BR135 ^c	BRH135	BR235	BRH235	BR335	BRH335
40	#14-4	BR140 ^c	BRH140	BR240	BRH240	BR340	BRH340
45	#14-4	—	BRH145	BR245	BRH245	BR345	BRH345
50	#14-4	BR150 ^c	BRH150	BR250	BRH250	BR350	BRH350
60	#8-1/0	BR160 ^c	BRH160	BR260	BRH260	BR360	BRH360
70	#8-1/0	BR170 ^c	BRH170	BR270	BRH270	BR370	BRH370
80	#8-1/0	—	—	BR280	BRH280	BR380	BRH380
90	#8-1/0	—	—	BR290	BRH290	BR390	BRH390
100	#8-1/0	—	—	BR2100	BRH2100	BR3100	BRH3100
110	#8-1/0	—	—	—	—	—	—
125	#4-2/0 ^e	—	—	BR2125 ^e	—	^e	—
150	^e	—	—	^e	—	^e	—
175	^e	—	—	^e	—	^e	—
200	^e	—	—	^e	—	^e	—
Requires one 1-Inch (25.4 mm) space				Requires two 1-Inch (25.4 mm) spaces		Requires three 1-Inch (25.4 mm) spaces	

a All Type BR single-, two-, and three-pole circuit breakers carry listing for HACR application..

b Breaker shunt trips are available but only in 120 Vac format. Addition of a shunt trip adds a 1-inch space width. For circuit breakers requiring a shunt trip add an ST suffix to the end of the catalogue number (e.g. BR115ST).

c Available with high magnetic setting for switching large tungsten lamp loads. Add suffix H to catalogue number (e.g. BR115H).

d Switching duty rated.

e For subfeed applications in 200 or 400 A loadcentres requiring a 125, 150, 175, or 200 A subfeed circuit breaker a Type BJ circuit breaker can be used. Refer to **page 63** for product space requirements and selection.

Plug-in circuit breakers for CPM/CPL/BRPM/BRPL

Type DNPL Duplex™, Independent Quadplex™ and circuit breaker packs

Type DNPL ^{ab}

- 10,000 A interrupting capacity at 120 Vac, 120/240 Vac, and 240 Vac

Table 12. Duplex and Independent Trip Quadplex plug-in circuit breakers

Duplex 2 single-pole circuits 10 per shelf carton		Quadplex independent trip 2 single-pole circuits and 1 two-pole circuit 5 per shelf carton				Quadplex independent trip 2 two-pole circuits 5 per shelf carton			
120 Vac		120 Vac	120/240 Vac	120 Vac	120/240 Vac				
Ampere rating	Catalogue number	Outer left (single-pole) ampere rating	Centre (two-pole) ampere rating	Outer right (single-pole) ampere rating	Catalogue number	Outer left and right (two-pole) ampere rating	Centre (two-pole) ampere rating	Catalogue number	Wire size range (Cu/Al 60 °C or 75 °C)
15–15	DNPL1515	15	15	15	DNPL151515	15	15	DNPL215215	#14–4 AWG
15–20	DNPL1520	15	20	15	DNPL152015	15	20	DNPL215220	#14–4 AWG
15–30	DNPL1530	15	25	15	DNPL152515	15	30	DNPL215230	#14–4 AWG
20–20	DNPL2020	15	30	15	DNPL153015	15	40	DNPL215240	#14–4 AWG
—	—	15	40	15	DNPL154015	20	20	DNPL220220	#14–4 AWG
—	—	15	50	15	DNPL155015	20	30	DNPL220230	#14–4 AWG

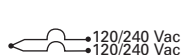

Requires one 1.00 inch (25.4 mm) space

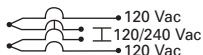

Independent trip requires two 1.00 inch (25.4 mm) spaces

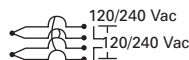

Independent trip requires two 1.00 inch (25.4 mm) spaces

a All Type DNPL Duplex and Quadplex circuit breakers carry listing for HACR applications.

b All 15 and 20 A single-pole are switch-duty rated.

Type BP (circuit breaker packs)

- Single carton packaged
- Represents common household combinations



DNPL2020



DNPL155015

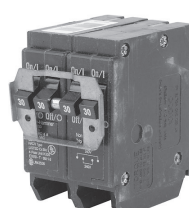

DNPL230230

Table 13. Plug-in circuit breaker house packs

Contents	Catalogue number
(3) DNPL151515, (1) DNPL153015, (1) DNPL154015	BP2
(10) BR115, (3) BR215, (1) BR230, (1) BR240	BP4
(2) DNPL1515, (1) DNPL215215, (1) DNPL152015, (1) DNPL153015, (1) DNPL154015	BP16
(6) DNPL1515, (2) DNPL151515, (1) DNPL153015, (1) DNPL154015	BP18
(1) DNPL1515, (3) DNPL151515, (2) DNPL153015, (1) DNPL154015	BP21
(3) DNPL1515, (3) DNPL151515, (1) DNPL153015, (1) DNPL154015	BP23
(16) BR115, (3) BR215, (1) BR230, (1) BR240	BP24
(14) BR115, (2) BR120, (1) BR230, (1) BR240	BP27
(5) DNPL1515, (1) DNPL2020, (1) DNPL153015, (1) DNPL154015	BP31
(1) BR120, (4) DNPL1515, (1) DNPL151515, (1) DNPL153015, (1) DNPL154015	BP32
(10) BR115, (2) BR120, (1) BR215, (1) BR220, (1) BR230, (1) BR240	BP41
(3) DNPL1515, (1) DNPL153015, (1) DNPL154015, (1) DNPL2020, (1) DNPL1520	BP54

Type BR arc fault circuit interrupter

Type BR arc fault circuit interrupter circuit breakers

- 10,000 A interrupting capacity at 120 Vac, 120/240 Vac, and 240 Vac

An arc fault circuit interrupter is a device intended to provide protection from the effects of arc faults by recognizing characteristics unique to arcing and by functioning to de-energize the circuit when the arc fault is detected. As of January 1, 2015, the Canadian Electrical Code now requires that all branch circuits that supply 125 V, single-phase, 15 and 20 A receptacle outlets installed in dwelling unit shall be protected by a combination arc fault circuit interrupter(s) (series arc and parallel arc detection).

Table 14. Single- and two-pole plug-in AFCI circuit breakers

Ampere rating	Configuration	Catalogue number		Two-pole ^a 120/240 Vac 5 per shelf carton 10 kAIC	Wire size range (Cu/Al 60 °C or 75 °C)
		Plug-on Neutral Breaker ^e	Pigtail Breaker		
15	Combination	BRP115AFC ^d	BRN115AFC ^d	BRL215CAF ^{bc}	#14–4 AWG
15	High interrupting 22 kAIC		BRHN115AF	—	#14–4 AWG
20	Combination	BRP120AFC ^d	BRN120AFC ^d	BRL220CAF ^{bc}	#14–4 AWG
20	High interrupting 22 kAIC		BRHN120AF	—	#14–4 AWG
				Requires one 1.00 inch (25.4 mm) space	Requires two 1.00 inch (25.4 mm) spaces

^a Common trip refers to two-pole 240 V load application sourced by 120/240 Vac (see **Figure 2**).

^b Will not fit into CPM112, CPL112, CPL116, CPL120, CPL220, CPL240, 3CPM112, 3CPL218, 3CPL224 or 3CPL230 prior to November 2004.

^c Long style circuit breakers. Please speak to your local Eaton sales rep for proper application.

^d CSA marked only

^e Only for use in the Type BR plug-on neutral style of combination and non-combination loadcentres

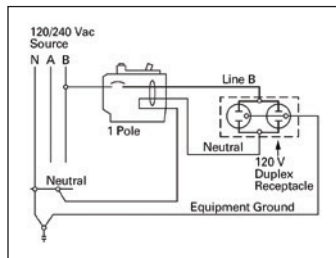

Figure 1. Single-pole, single 120 V load application sourced by 120/240 Vac

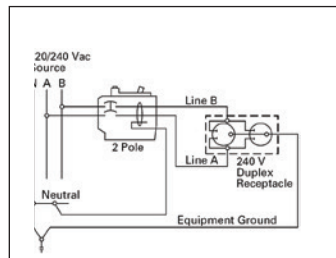

Figure 2. Two-pole, 240 V load application sourced by 120/240 Vac



Type BR combination AFCI circuit breaker



Type BR dual purpose AF/GF breaker



Type BR fire alarm breaker features red handle

Table 15. Single-pole plug-in dual purpose AF/GF breakers

Ampere rating	Configuration	Catalogue number	
		Pon Breaker ^b	Pigtail Breaker
15	CAFCI / 5 mA GF	BRP115DFC ^a	BRN115DFC ^a
20	CAFCI / 5 mA GF	BRP120DFC ^a	BRN120DFC ^a
Compact body breaker		Requires one 1.00 inch (25.4 mm) space	

^a CSA marked only

^b Only for use in the Type BR plug-on neutral style of combination and non-combination loadcentres

Table 16. Single-pole plug-in fire alarm breakers

Ampere rating	Configuration	Single-pole, 120/240 Vac 10 per shelf carton, 10 kAIC
		Catalogue number
15	Branch fire alarm	BRF115
20	Branch fire alarm	BRF120
Compact body breaker		Requires one 1.00 inch (25.4 mm) space

Plug-in circuit breakers for CPM/CPL/BRPM/BRPL

Types GFCB and GFEP ground fault

Type GFCB and GFEP ground fault circuit breakers

- 10,000/22,000 A interrupting capacity at 120 Vac and 120/240 Vac
- 5 mA “people protection,” or 30 mA equipment protectors
- Two-pole version features common trip



GFTCB single-pole



GFTCB two-pole

Table 17. (5 mA) single- and two-pole plug-in ground fault circuit breakers

Ampere rating	Wire size range Cu/Al 60 °C or 75 °C (AWG)	Catalogue number		Two-pole, 120/240 Vac 1 per shelf carton		
		Plug-on Breaker ^d 10 kAIC	Pigtail Breaker 10 kAIC	22 kAIC	10 kAIC	22 kAIC
15	#14–8	BRP115GFC ^c	BRN115GFC ^{a c}	BRHN115GF	GFTCB215	GFTCBH215
20	#14–8	BRP120GFC ^c	BRN120GFC ^{a c}	BRHN120GF	GFTCB220	GFTCBH220
25	#14–8	—	BRN125GFC ^c	BRHN125GF	GFTCB225	GFTCBH225
30	#14–8	—	BRN130GFC ^c	BRHN130GF	GFTCB230	GFTCBH230
40	#14–8	—	—	—	GFTCB240	—
50	#14–8	—	—	—	GFTCB250 ^b	—
60	#14–4	—	—	—	GFTCB260	—

Requires one 1.00 inch (25.4 mm) space Requires two 1.00 inch (25.4 mm) spaces

a Auxiliary switches and bell alarms are available under special order with legacy part number (GFTCB115 and GFTCB120).

Add suffix W1 for alarm switch and W2 for auxiliary switch.

b For use with copper wire only.

c CSA marked only.

d Only for use in the Type BR plug-on neutral style of combination and non-combination loadcentres.

Table 18. (30 mA) single- and two-pole plug-in ground fault circuit breaker equipment protectors

Ampere rating	Wire size range Cu/Al 60 °C or 75 °C (AWG)	Pigtail Breaker	
		Single-pole, 120 Vac, 1 per shelf carton 10 kAIC	Two-pole, 120/240 Vac 1 per shelf carton 10 kAIC
15	#14–8	BRN115EP	GFEP215
20	#14–8	BRN120EP	GFEP220
25	#14–8	BRN125EP	GFEP225
30	#14–8	BRN130EP	GFEP230
40	#14–8	—	GFEP240
50	#14–8	—	GFEP250 ^a

Requires one 1.00 inch (25.4 mm) space Requires two 1.00 inch (25.4 mm) spaces

a For use with copper wire only.

Ground fault application note

Single-pole ground fault circuit breakers (GFCBs) are designed for use in two-wire, 120 Vac circuits. **Figure 3** shows a typical wiring configuration. Two-pole GFCBs are designed for use in three-wire, 120/240 Vac circuits, 120 Vac multi-wire circuits employing common, neutral and two-wire, 240 Vac circuits obtained from a 120/240 Vac source. **Figure 4** and **Figure 6** illustrate typical wiring configurations for 120/240 Vac multi-wire circuits. **Figure 5** depicts a 240 Vac, two-wire circuit.

Note: The “panel neutral” conductor connects to the neutral bar, even though the neutral is not included in the load circuit. This connection is necessary to supply a 120 Vac power source to the ground fault sensing circuit. The figures are shown with a 120/240 Vac, single-phase, three-wire power source, but are also applicable to a 120/208 Vac, three-phase, four-wire power supply. For all figures, the electrical operation of the GFCB is not affected by the equipment ground.

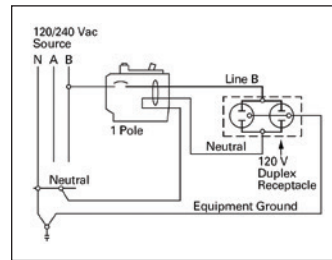

Figure 3. Single-pole

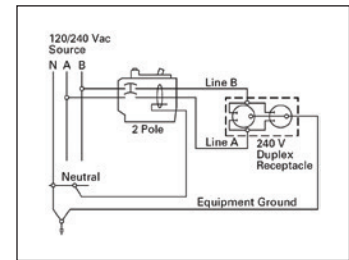

Figure 5. Two-pole

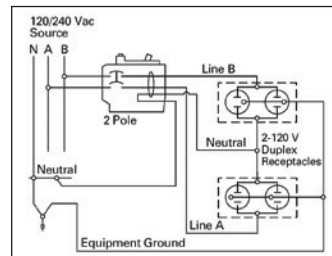

Figure 4. Two-pole

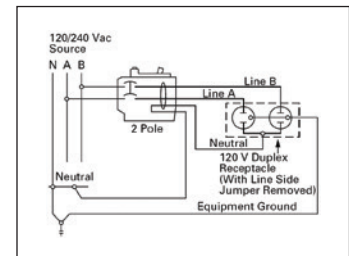

Figure 6. Two-pole

Type BR internationally rated

Type BR internationally rated circuit breakers

- **3000/6000 A** interrupting capacity at 240/415 Vac
- Two- and three-pole versions feature common trip



BR120E



BR215E



BR320E

Table 19. Single-, two-, and three-pole plug-in internationally rated circuit breakers ^{ab}

Ampere rating	Wire size range Cu/Al 60 °C or 75 °C (AWG)	Catalogue number					
		Single-pole, 240/415 Vac 10 per shelf carton		Two-pole, 240/415 Vac 5 per shelf carton		Three-pole, 240-415 Vac 5 per shelf carton	
		3 kAIC	6 kAIC	3 kAIC	6 kAIC	3 kAIC	6 kAIC
15	#14-4	BR115E	BRH115E	BR215E	BRH215E	BR315E	BRH315E
20	#14-4	BR120E	BRH120E	BR220E	BRH220E	BR320E	BRH320E
25	#14-4	BR125E	BRH125E	BR225E	BRH225E	BR325E	BRH325E
30	#14-4	BR130E	BRH130E	BR230E	BRH230E	BR330E	BRH330E
35	#14-4	BR135E	BRH135E	BR235E	BRH235E	BR335E	BRH335E
40	#14-4	BR140E	BRH140E	BR240E	BRH240E	BR340E	BRH340E
45	#14-4	—	BRH145E	BR245E	BRH245E	BR345E	BRH345E
50	#14-4	BR150E	BRH150E	BR250E	BRH250E	BR350E	BRH350E
60	#4-1/0	BR160E	BRH160E	BR260E	BRH260E	BR360E	BRH360E
70	#4-1/0	BR170E	BRH170E	BR270E	BRH270E	BR370E	BRH370E
80	#4-1/0	—	—	BR280E	BRH280E	BR380E	BRH380E
90	#4-1/0	—	—	BR290E	BRH290E	BR390E	BRH390E
100	#4-1/0	—	—	BR2100E	BRH2100E	BR3100E	BRH3100E
Requires one 1.00 inch (25.4 mm) space				Requires two 1.00 inch (25.4 mm) spaces		Requires three 1.00 inch (25.4 mm) spaces	

a Built to British Standard BS3871.

b Non-stocked item requiring special order. Speak to your local Eaton sales rep for lead times.

Table 20. Duplex, 2 single-pole circuits, 240/415 Vac

Ampere rating	Catalogue number
15-15	DNPL1515E
15-20	DNPL1520E
20-20	DNPL2020E
—	—
—	—
Requires one 1.00 inch (25.4 mm) space	

Plug-in circuit breakers for CPM/CPL/BRPM/BRPL

Type GFXB internationally rated ground fault and Type BR moulded case switches

Type GFXB internationally rated ground fault circuit breakers

- 3000 A interrupting capacity at 120/240 Vac, 220/380 Vac, and 240/415 Vac



Type GFXB

Table 21. 30 mA single-pole plug-in ground fault circuit breakers ^{abc}

Ampere rating	Wire size range Cu/Al 60 °C or 75 °C (AWG)	Catalogue number ^a Single-pole, 120 Vac 1 per shelf carton 3 kAIC
15	#14-4	GFXB115B2
20	#14-4	GFXB120B2
25	#14-4	GFXB125B2
30	#14-4	GFXB130B2

Requires one 1.00 inch (25.4 mm) space

^a Auxiliary switches and bell alarms are available under special order. Add suffix W1 for alarm switch and W2 for auxiliary switch.

^b Meets requirements of BS3871 section 31C and BS4293.

^c Non-stocked part requiring special ordering. Speak to your local Eaton sales rep for lead times.

Type BR non-automatic moulded case switches



BR250NA

Table 22. Two-pole plug-in non-automatic moulded case switches ^a

Ampere rating	Wire size range Cu/Al 60 °C or 75 °C (AWG)	Catalogue number ^a Two-pole, 120/240 Vac 5 per shelf carton
50	#4-1/0	BR250NA
60	#4-1/0	BR260NA
100	#4-1/0	BR2100NA

Requires two 1.00 inch (25.4 mm) spaces

^a Non-stocked part requiring special ordering. Speak to your local Eaton sales rep for lead times.

Plug-in loadcentre main circuit breakers for BR

Type CSR, and CC

Type CSR loadcentre main circuit breaker kit

- 25,000 A interrupting capacity at 120/240 Vac



CSR2150N

Type CC loadcentre main circuit breaker kit

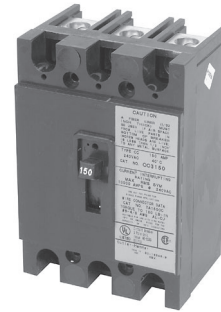

CC3150

Table 23. Two-pole main circuit breakers for single-phase plug-in combination loadcentres

Ampere rating	Wire size range Cu/Al 60 °C or 75 °C	Catalogue number
		Two-pole, 120/240 Vac 1 per shelf carton 25 kAIC
125	#2 AWG–300 kcmil	CSR2125N
150	#2 AWG–300 kcmil	CSR2150N
200	#2 AWG–300 kcmil	CSR2200N

Table 24. Three-pole main circuit breakers for three-phase plug-in combination loadcentres

Ampere rating	Wire size range Cu/Al 60 °C or 75 °C	Catalogue number
		Three-pole, 120/240 Vac 1 per shelf carton 10 kAIC
100	#4 AWG–4/0 AWG	CC3100
125	#2 AWG–300 kcmil	CC3125
150	#2 AWG–300 kcmil	CC3150
200	#2 AWG–300 kcmil	CC3200

Plug-in circuit breaker accessories for BR loadcentres

Plug-in circuit breaker accessories



Table 25. Field installation kits and parts for plug-in loadcentre circuit breakers

Description	Ordering quantity ^a	Catalogue number
Handle tie for single-pole Type BR circuit breakers. Joins handles on breakers mounted adjacent to each other via a clip-on mechanism.	1	BQHT-10
Handle tie for Type DNPL circuit breakers. Joins the two outside independent poles on two adjacent duplex or one quadplex circuit breakers.	1	THOW-10
Handle tie for Type DNPL circuit breakers. Joins the outside independent poles on adjacent duplex or quadplex circuit breakers.	1	THS1
Handle lockoff (escutcheon mounted). Single-, two-, or three-pole Type BR; single-pole of a Type DNPL duplex or; one independent outside pole of a Type DNPL quadplex circuit breakers.	1	BRLW-10
Handle lockoff (handle mounted). Single-pole Type BR circuit breakers. ^b	1	BRLW1-10
Handle lockoff (handle mounted). Two- and three-pole Type BR circuit breakers. ^b	1	BRLW2-10
Handle lockoff (handle mounted). Single-pole Type DNPL quadplex circuit breakers. ^b	1	BRDL1-10
Handle lockoff (escutcheon mounted). Two-pole Type DNPL quadplex circuit breakers. ^b	1	BRQLW-10
Handle lockoff (screw mounted). Locks the handle of main circuit breaker types CC and CHH in the OFF or ON position. ^b	1	CCPL
Handle lockoff (escutcheon mounted). Locks the handle of main circuit breaker type CSR and BWH in the OFF or ON position. ^b	1	MCBPL
Handle lockdog (escutcheon mounted). Single-, two-, and three-pole Type BR; single-pole of a Type DNPL duplex or; one independent pole of a Type DNPL quadplex circuit breaker. Secures handle in the ON or OFF position. ^b	1	BHLW-10
Handle lockdog (handle mounted). Single-pole Type BR circuit breakers. Secures handle in the ON or OFF position. ^b	1	BHLW1-10
Handle lockdog (handle mounted). Two- and three-pole Type BR circuit breakers. Secures handle in the ON or OFF position. ^b	1	BHLW2-10
Handle lockdog (handle mounted). Single-pole Type GFCB ground fault circuit breakers. Secures handle in the ON or OFF position. ^b	1	BHGW-10
Handle lockdog (handle mounted). Single-pole Type DNPL duplex or 1 outside independent pole of a quadplex. Secures handle in the ON or OFF position. ^b	1	HLW1-10
Main breaker lug kit. Types CC and CHH circuit breakers (2) 300 kcmil	1	CCL300
Main breaker lug kit. Types CSR, BW, and BWH circuit breakers (2) 300 kcmil	1	MCBL300
Electronic breaker lockoff (escutcheon mounted): Type BR long body AF/GF	1	BRLAFGFLOFF
Electronic breaker lockoff (escutcheon mounted): Type BR compact body AF	1	BRCAFLOFF

^a Must be purchased in multiples of ordering quantities indicated.

^b Refer to your local Eaton sales representative for handle position changeability chart.

Definitions

Handle ties: Devices used to join two similar independent single-pole circuit breakers to form a two-pole non-common trip breaker.

Handle lockoffs: Devices that use a padlock to lock a circuit breaker's handle in either the ON or OFF position.

Handle lockdogs: Devices used to secure a circuit breaker's handle in the ON or OFF position. They are not padlockable devices.

Escutcheon mounted: A semipermanent mounting to the face of the circuit breaker and secured by the loadcentre's deadfront cover.

Handle mounted: A mounting made directly to the handle of the circuit breaker by means of a set screw.

Screw mounted: A permanent mounting to the face of the circuit breaker by means of a non-removable screw.

Plug-in OEM loadcentre interior assemblies

Product description

As a leader in the electrical distribution equipment business, Eaton has a unique product offering for equipment manufacturers, panel builders and virtually any OEM that has a need for power distribution within their equipment. The OEM interior offering consists of a wide variety of power distribution options utilizing components from Eaton's BR Loadcentre product lines. With high-volume, standardized products, OEMs can expect to receive high-quality products covering configurations meeting virtually any power distribution need.

Coupled with Eaton's expertise in circuit breaker design and manufacturing, our OEM interiors provide solid power distribution and circuit protection in a compact, easy-to-install package.

Product offering

The BR interiors are manufactured of formed, plated aluminum, and use the Eaton Type BR 1.00 inch (25.4 mm) wide circuit breaker by Eaton. This design affords customers the most circuit flexibility as many of these interiors allow the installation of standard single- and two-pole breakers as well duplex (two-pole in a 1.00 inch (25.4 mm) space) or quadplex (four-pole in a 2.00 inch (50.8 mm) space) breakers. The stab rating of the BR interiors is 140 A maximum, meaning that the handle rating of the breakers that are mounted across from one another may not exceed 140 A.

The interiors are designed for either horizontal (single-row breaker mounting), or vertical (double-row breaker mounting).

Standards and certifications

Canadian Standards Association listing

All single- and two-pole, 120/240 V breakers, both 1-inch (25.4 mm), 1/2-inch (12.7 mm) and 3/4-inch (19.1 mm) per pole, 225 A maximum, are listed as certified by the Canadian Standards Association, Guide No. 69-11.19, Class 1432, File 18328.

Underwriters Laboratories listing

All grounding bars manufactured comply with Underwriters Laboratories standards and are listed under Guide No. DHJR, File E31424, Volume W, Section 17.

All circuit breakers 10 A and larger comply with the Underwriters Laboratories "Standard for Branch Circuit and Service Circuit-Breakers" UL 489; Guide No. 60 10.2 File E31424, and "Requirements for Wire Connectors and Soldering Lugs," UL 486B, Guide No. 461 10-C File E7830.

All Eaton breakers where marked, are suitable for use with 60/75 ° rated wire, unless otherwise specified.

All devices comply with the 22–10 kAIC UL series connected components File DKS2 of the Recognized Components Index.

Product selection

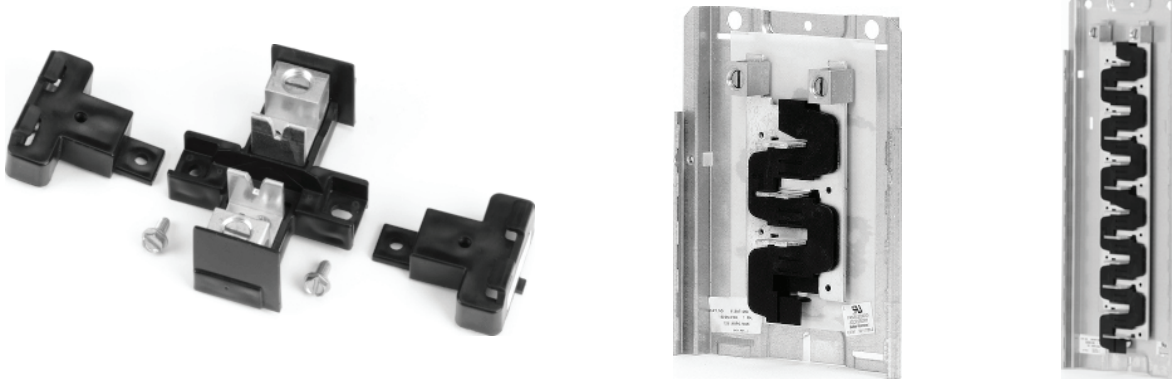

Table 26. Plug-in OEM loadcentre interior assemblies

Ampere rating	1-inch spaces	½-inch spaces	Main terminal size (per phase)	Package quantity	Catalogue number
125	4	8	(1) 2/0-#14 AWG Cu/Al	20	48INT125B
125	8	16	(1) 2/0-#14 AWG Cu/Al	20	816INT125B
125	12	24	(1) 2/0-#14 AWG Cu/Al	20	1224INT125B
125	16	24	(1) 2/0-#14 AWG Cu/Al	20	1624INT125B
125	20	24	(1) 2/0-#14 AWG Cu/Al	10	2024INT125B
125	24	24	(1) 2/0-#14 AWG Cu/Al	10	2424INT125B

Plug-in OEM loadcentre interior assemblies

Dimensions

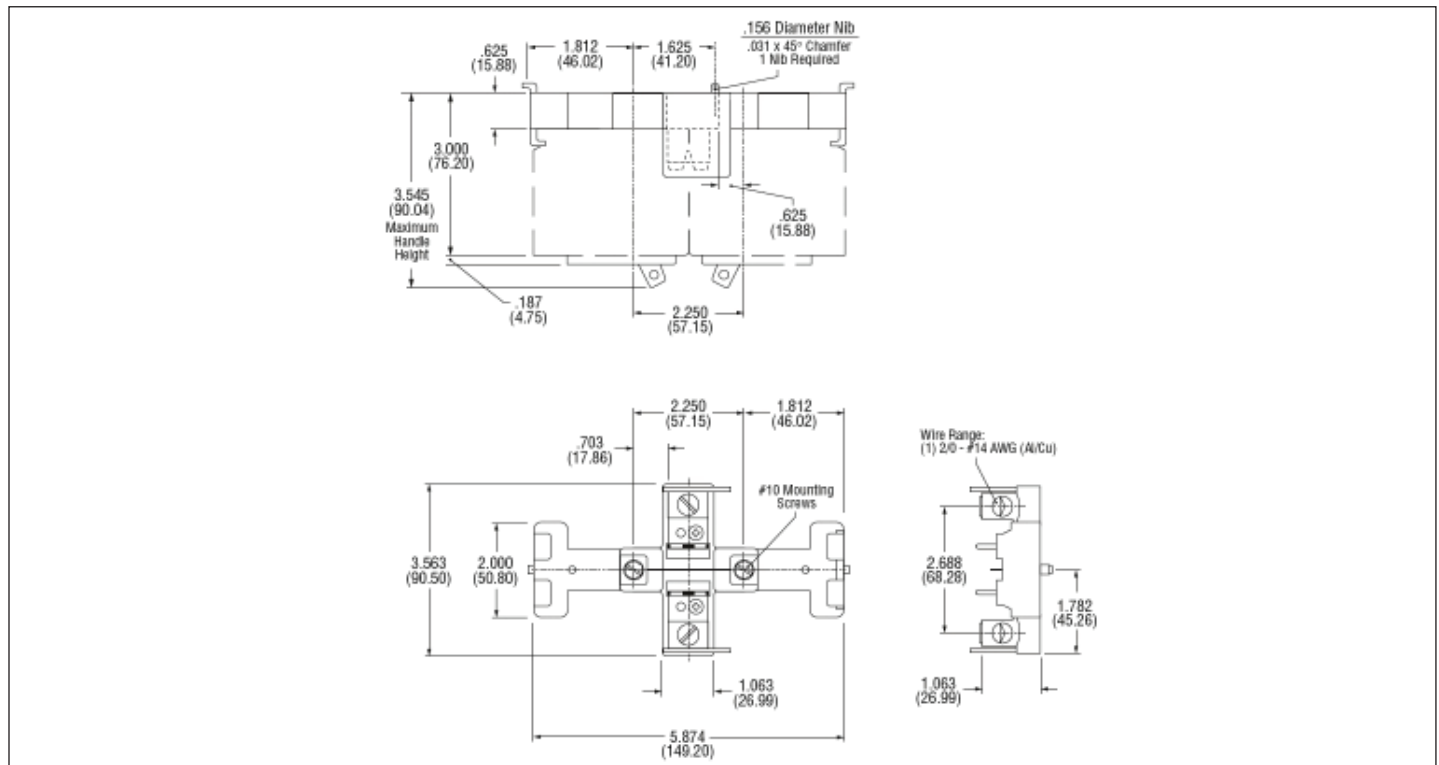

Figure 7. 48INT125B

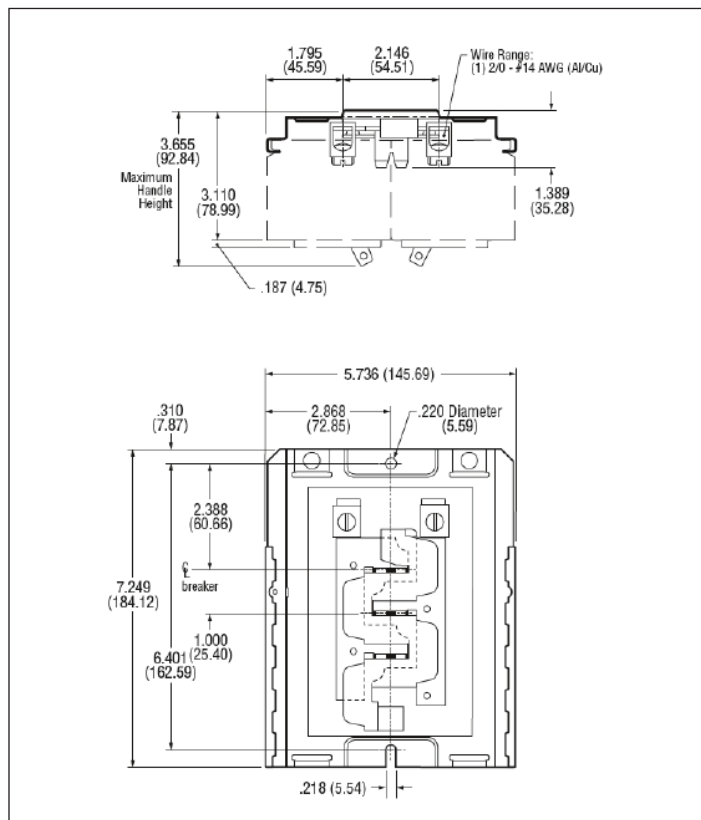

Figure 8. 816INT125B

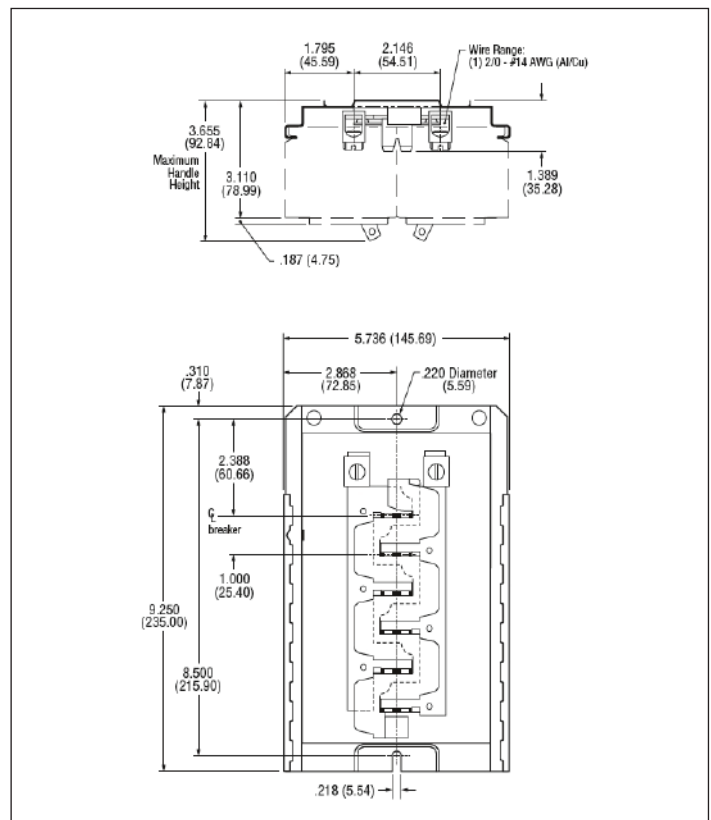

Figure 9. 1224INT125B

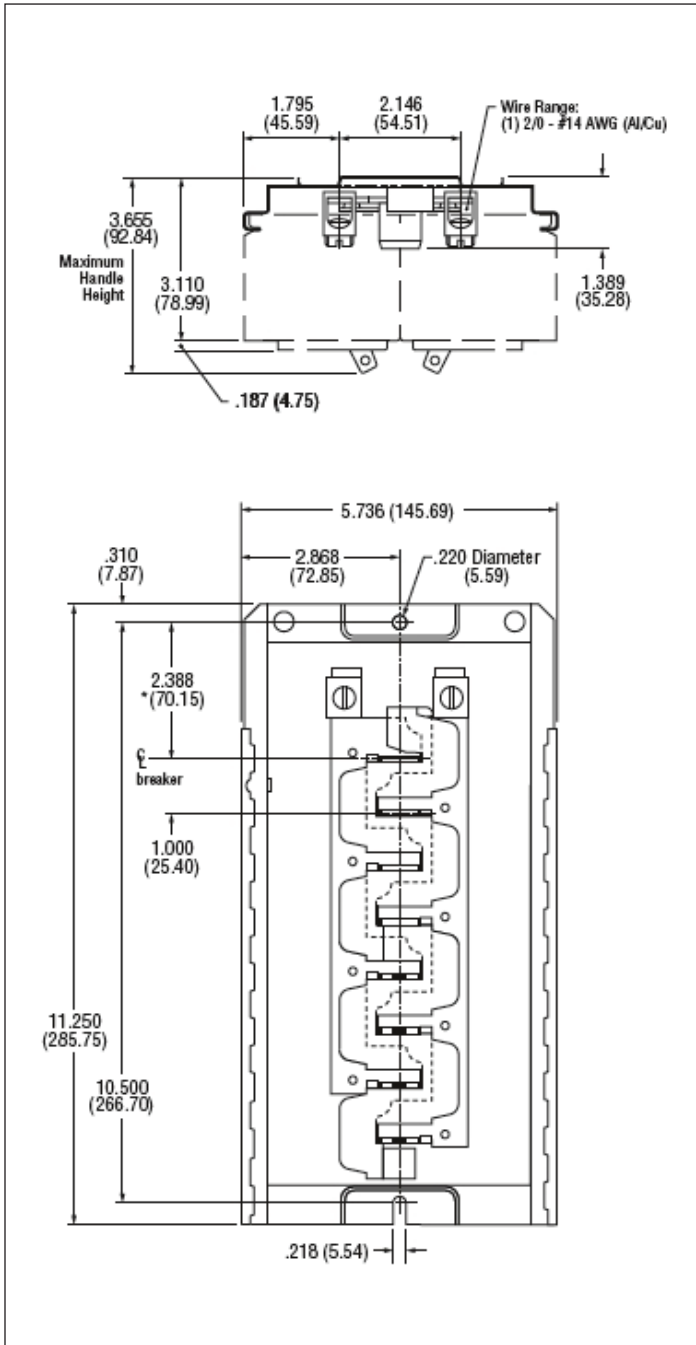

Figure 10. 1624INT125B

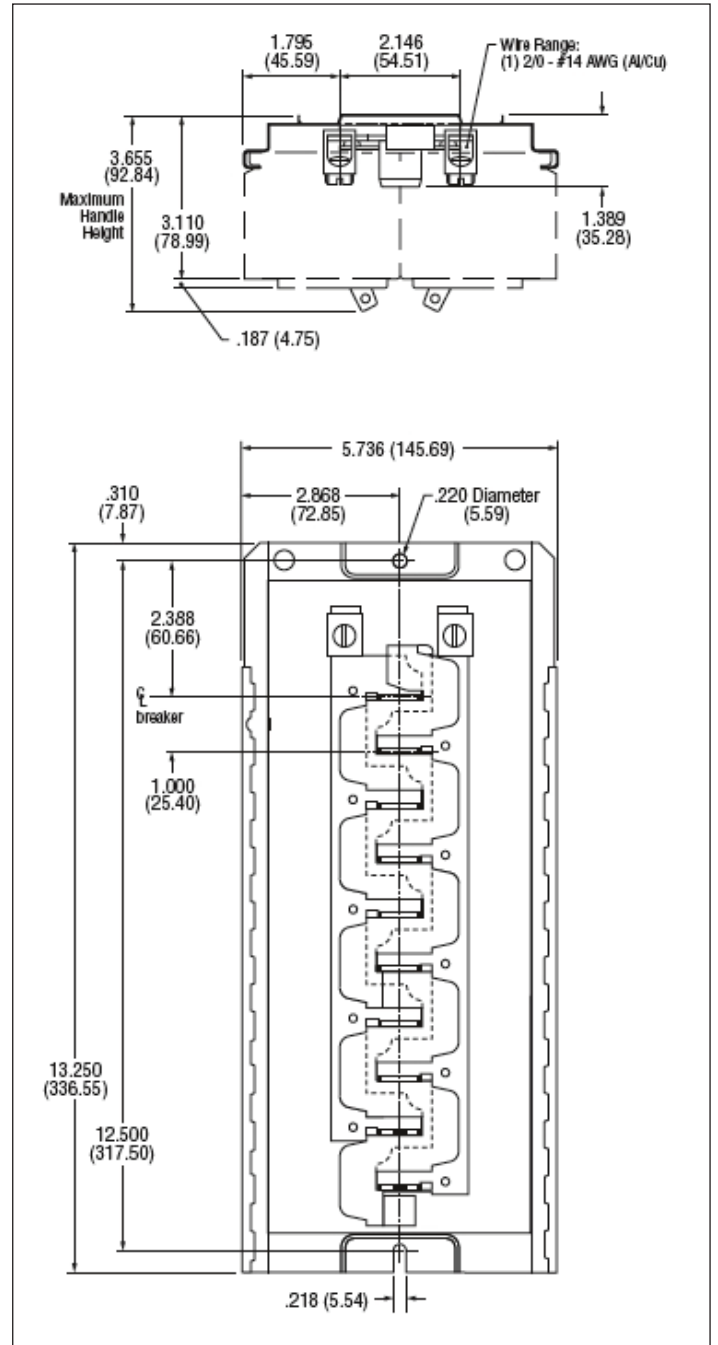

Figure 11. 2024INT125B

Plug-in OEM loadcentre interior assemblies

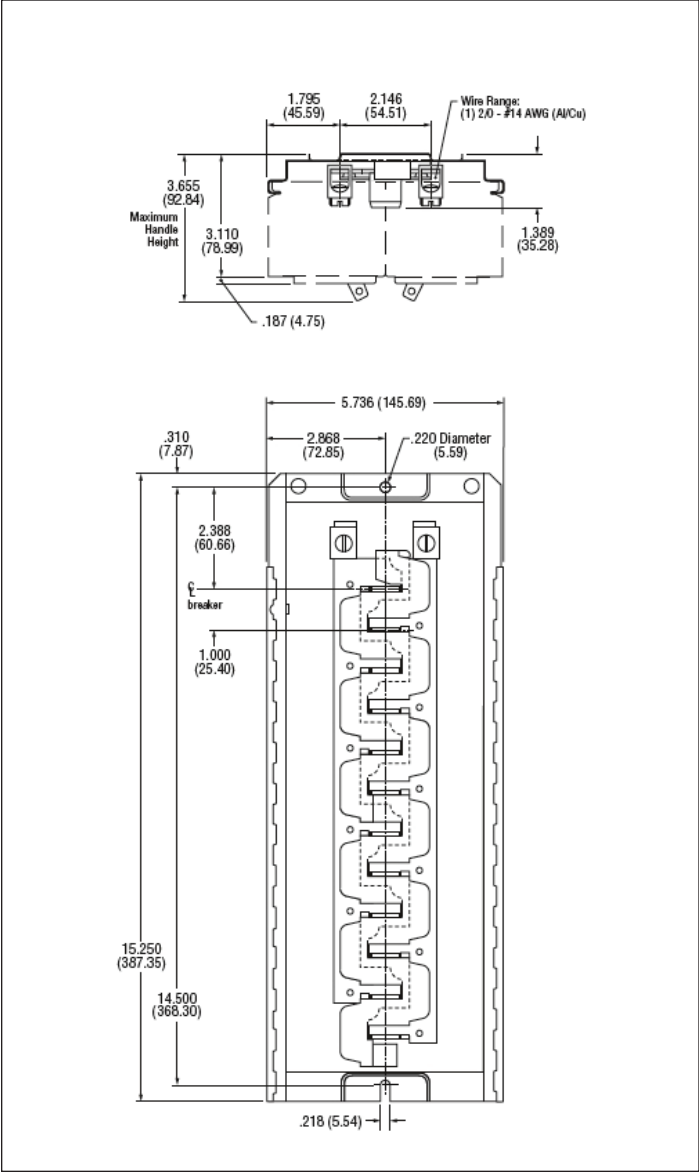

Figure 12. 2424INT125B

Product description

Loadcentres feature factory installed main lugs or main circuit breakers. The CH interiors are manufactured of formed, silver flash plated copper. Eaton also supplies a full line of Type CH branch circuit breakers and accessories for these loadcentres.

Product application

Designed for the protection and distribution of single and multi-dwelling residential and light commercial loads to 120/240 volts AC, such as lighting, heating, appliance and small motor branch circuits. All main circuit breaker combination loadcentres are CSA listed for use as service entrance equipment.

Ratings

Single-phase, three-wire, 120/240 volts AC. Mains through 200 A. Available with up to 120 branch circuits. Main breakers on 100 and 200 A panels are rated at 35,000 AIC.

Metal enclosure specifications

Enclosures are made of 16 gauge galvanized sheet steel powder coated sandalwood beige. The galvanized coating provides corrosion protection. Trims are similarly scratch-resistant powder coated a sandalwood beige colour to match the tub. A combination surface/flush cover with integral door is supplied.

All plug-in loadcentres are CSA listed to file LL98266.

Warranty

Limited lifetime.

Type CH plug-on neutral loadcentre features and benefits

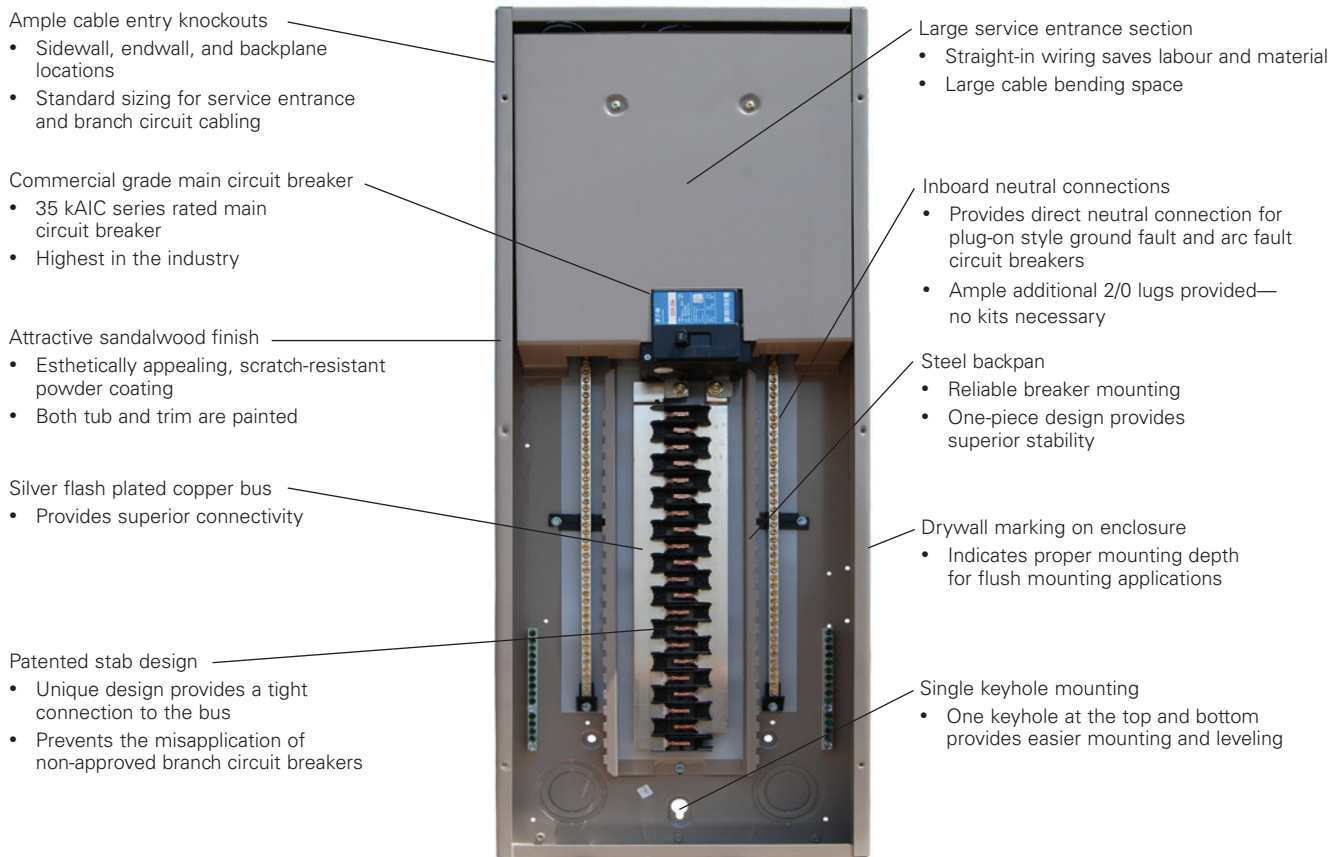

Type CH plug-in loadcentres

Combination and non-combination single-phase

Three-wire 120/240 Vac plug-on neutral style combination service entrance Type 1 (indoor)

Table 27. Type CH Main circuit breaker plug-on neutral indoor Type 1 loadcentres

Maximum ampere rating	Main breaker rating	Max. no. 3/4-inch spaces	Cover style	Type of main circuit breaker	Dimensions in inches (mm)			Wire size range for main Cu/Al	Catalogue number
					H	W	D		
100	100	24	Flush/surface	CSR	29.13 (739.8)	14.3 (363.2)	3.9 (99.06)	#2–300 kcmil	CCHPM124
100	100	32	Flush/surface	CSR	34.13 (866.8)	14.3 (363.2)	3.9 (99.06)	#2–300 kcmil	CCHPM132
125	125	32	Flush/surface	CSR	34.13 (866.8)	14.3 (363.2)	3.9 (99.06)	#2–300 kcmil	CCHPM132Z
100	100	42	Flush/surface	CSR	37.00 (939.8)	14.3 (363.2)	3.9 (99.06)	#2–300 kcmil	CCHPM142
125	125	42	Flush/surface	CSR	37.00 (939.8)	14.3 (363.2)	3.9 (99.06)	#2–300 kcmil	CCHPM142Z
200	200	42	Flush/surface	CSR	37.00 (939.8)	14.3 (363.2)	3.9 (99.06)	#2–300 kcmil	CCHPM242
200	200	60	Flush/surface	CSR	45.00 (1143.0)	14.3 (363.2)	3.9 (99.06)	#2–300 kcmil	CCHPM260

Three-wire 120/240 Vac plug-on neutral style non-combination service entrance Type 1 (indoor)

Table 28. Type CH main lug only plug-on neutral indoor Type 1 loadcentres

Maximum ampere rating	Max. no. 3/4-inch spaces	Cover style	Dimensions in inches (mm)			Wire size range for main Cu/Al	Catalogue number
			H	W	D		
125	24	Flush/surface	29.13 (739.8)	14.3(363.2)	3.9 (99.06)	#2–300 kcmil	CCHPL124
225	32	Flush/surface	34.13 (866.8)	14.3(363.2)	3.9 (93.06)	#2–300 kcmil	CCHPL232

Three-wire 120/240 Vac standard neutral non-combination Type 3R (outdoor/raintight) ^{ab}



CH6L125R



RCCHL102

Table 29. Type CH main lug only standard neutral outdoor/raintight Type 3R loadcentres ^a

Maximum ampere rating	Catalogue number	Max. no. 3/4-inch spaces	Max. no. 3/8-inch spaces	Enclosure style	Dimensions in inches (mm)			Wire size range for main CU/AL
					H	W	D	
100	RCCHL102	2	4	Indoor/outdoor Type 3R ^{ac}	12.00 (304.8)	6.88 (174.62)	4.38 (111.13)	#14–1/0
125	CH6L125R	6	12	Indoor/outdoor Type 3R	12.00 (304.8)	6.88 (174.62)	4.38 (111.13)	#14–1/0

^a Outdoor loadcentres accommodate Type DS conduit hubs. Hubs not included. See **page 15** for selection.

^b Does not accept plug-on neutral style of arc fault and ground fault circuit breakers. Uses standard type arc fault and ground fault circuit breakers.

^c Enclosure assembly incorporates a swing out locking hasp for the cover.

Type CH single, multi-pole, and twin

Type CH plug-in circuit breakers ^a

- 10,000 A interrupting capacity at 120/240 Vac
- Flag trip models provide visual indication of trip

Product selection

Table 30. Single- and multi-pole plug-in breakers

Ampere rating	Wire size range (Cu/AL 60 °C or 75 °C) (AWG)	Catalogue Number		
		Single-pole, 120/240 Vac Flag trip indication 10 per shelf carton	Two-pole, 120/240 Vac Flag trip indication 5 per shelf carton	Three-pole, 240 Vac Standard 5 per shelf carton
10	(1) #14-8 b, (2) #14-10 bc, (1) #14-6 d	—	—	—
15	(1) #14-8 b, (2) #14-10 bc, (1) #14-6 d	CHF115	CHF215	CH315 h
20	(1) #14-8 b, (2) #14-10 bc, (1) #14-6 d	CHF120	CHF220	CH320 h
25	(1) #14-8 b, (2) #14-10 bc, (1) #14-6 d	CHF125	CHF225	CH325 h
30	(1) #14-8 b, (2) #14-10 bc, (1) #14-6 d	CHF130	CHF230	CH330 h
35	#14-2 b, #14-6 d	CHF135	CHF235	CH335 h
40	#10-1/0 e, #14-2 f, #3-0 g	CHF140	CHF240	CH340 h
45	#10-1/0 e, #14-2 f, #3-0 g	CHF145	CHF245	CH345 h
50	#10-1/0 e, #14-2 f, #3-0 g	CHF150	CHF250	CH350 h
60	#10-1/0 e, #14-2 f, #3-0 g	CH160	CH260	CH360 h
70	#10-1/0 e, #14-2 f, #3-0 g	CH170	CH270	CH370 h
80	#10-1/0 e, #14-2 f, #3-0 g	—	CH280	CH380
90	#10-1/0 e, #14-2 f, #3-0 g	—	CH290	CH390
100	#10-1/0 e, #14-2 f, #3-0 g	—	—	CH3100
110	#10-1/0 e, #14-2 f, #3-0 g	—	—	—
125	#10-1/0 e, #14-2 f, #3-0 g	—	—	—

Requires three ¾-inch (19.1 mm) spaces

^a Not for use in Type BR loadcentres

^b For single- and two-pole breakers.

^c Solid and stranded wire can be used together.

^d For three-pole breakers.

^e Single-pole 60-70 A, two-pole 80-125 A, three-pole 40-100 A.

^f Single-pole 40-50 A, two-pole 40-70 A.

^g Two-pole 150 A.

^h HACR rated.

Type CH Twin Circuit Breakers ^{abc}

- 10,000 A interrupting capacity at 120/240 Vac
- Provides 2 single-pole circuits in one ¾-inch space

Table 31. Twin plug-in circuit breakers

Ampere rating	Wire size range (Cu/Al 60 °C or 75 °C) (AWG)	Catalogue number
		Single-pole, 120/240 Vac 10 per shelf carton
15-15	#14-8	CHT1515
15-20	#14-8	CHT1520
20-20	#14-8	CHT2020

Requires one ¾-inch (19.1 mm) space

^a Switching duty rated.

^b HACR rated.

^c Not for use in Type BR loadcentres i.e. CPM or CPL prefixed catalogue numbers.

Plug-in circuit breakers for CH

Type CHP commercial

Type CHP commercial circuit breakers ^a

- 10,000 A interrupting capacity at 120 Vac, 120/240 Vac, and 240 Vac
- Three-position trip breakers for commercial applications when On-Off and Trip position is required

Table 32. Commercial plug-in circuit breakers

Ampere rating	Wire size range (Cu/Al 60 °C or 75 °C) (AWG)	Catalogue number		
		Single-pole 120/240 Vac 10 per shelf carton	Two-pole 120/240 Vac 5 per shelf carton	Three-pole 240 Vac 5 per shelf carton
10	(1) #14-8 b, (2) #14-10 bc, (1) #14-6 d	CHP110	—	CHP310
15	(1) #14-8 b, (2) #14-10 bc, (1) #14-6 d	CHP115 gh	CHP215 h	CHP315 h
20	(1) #14-8 b, (2) #14-10 bc, (1) #14-6 d	CHP120 gh	CHP220 h	CHP320 h
25	(1) #14-8 b, (2) #14-10 bc, (1) #14-6 d	CHP125 h	CHP225 h	CHP325 h
30	(1) #14-8 b, (2) #14-10 bc, (1) #14-6 d	CHP130 h	CHP230 h	CHP330 h
35	#14-2 b, #14-6 d	CHP135 h	CHP235 h	CHP335 h
40	#10-1/0 e, #14-2 f	CHP140 h	CHP240 h	CHP340 h
45	#10-1/0 e, #14-2 f	CHP145 h	CHP245 h	CHP345 h
50	#10-1/0 e, #14-2 f	CHP150 h	CHP250 h	CHP350 h
60	#10-1/0 e, #14-2 f	— h	CHP260 h	CHP360 h
70	#10-1/0 e, #14-2 f	—	CHP270	CHP370
80	#10-1/0 e, #14-2 f	—	CHP280	—
90	#10-1/0 e, #14-2 f	—	CHP290	—
100	#10-1/0 e, #14-2 f	—	CHP2100	CHP3100
110	#10-1/0 e, #14-2 f	—	—	—
125	#10-1/0 e, #14-2 f	—	CHP2125	—
		Requires one ¾-inch (19.1 mm) space	Requires two ¾-inch (19.1 mm) spaces	Requires three ¾-inch (19.1 mm) spaces

a Not for use in Type BR loadcentres

b For single- and two-pole breakers.

c Solid and stranded wire can be used together.

d For three-pole breakers.

e Single-pole 60-70 A, two-pole 80-125 A, three-pole 40-100 A.

f Single-pole 40-50 A, two-pole 40-70 A.

g Switching duty rated.

h HACR rated.

Type CH arc fault circuit interrupter

Type CH arc fault circuit interrupter circuit breakers ^a

- 10,000 A interrupting capacity at 120 Vac, and 120/240 Vac
- Plug-on neutral style for plug-on neutral type CH loadcentres

A combination type arc fault circuit interrupter is a device intended to mitigate series and parallel arcing faults in the complete circuit, including connected cords. Parallel arcing faults can occur from line to neutral or line to ground. These arcing faults are in parallel with the load and produce the most energy of all arcing faults.

Table 33. Single- and two-pole plug-in FIRE-GUARD AFCI circuit breakers

Ampere rating	Wire size range (Cu/Al 60 °C or 75 °C) (AWG)	Configuration	Catalogue number	
			Single-pole, 120/240 Vac 10 per shelf carton 10 kAIC	Two-pole, 120/240 Vac 5 per shelf carton 10 kAIC ^b
15	#14-4	Pigtail	CHFCAF115	CH215CAF
15	#14-4	Plug-on neutral ^c	CHFCAF115PN	—
20	#14-4	Pigtail	CHFCAF120	CH220CAF
20	#14-4	Plug-on neutral ^c	CHFCAF120PN	—
			Requires one ¾-inch (19.1 mm) space	Requires two ¾-inch (19.1 mm) spaces

^a Not for use in Type BR loadcentres

^b Common trip refers to two-pole 240 V load application sourced by 120/240 Vac (see **Figure 14**).

^c Only for use in the Type CH plug-on neutral style of combination and non-combination loadcentres.

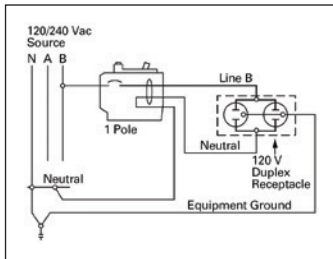

Figure 13. Single-pole, single 120 V load application sourced by 120/240 Vac

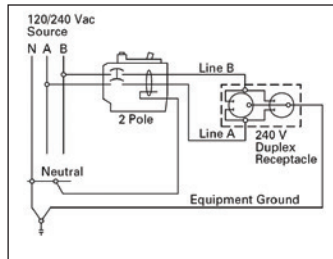

Figure 14. Two-pole, 240 V load application sourced by 120/240 Vac



Type CH single-pole AFCI circuit breaker



Type CH single-pole dual-purpose AFGF breaker

Table 34. Single-pole plug-in dual purpose AF/GF circuit breakers

Ampere rating	Wire size range (Cu/Al 60 °C or 75 °C) (AWG)	Configuration	Catalogue number	
			Single-pole 120/240 Vac 10 per shelf carton 10 kAIC	
15	#14-4	Pigtail	CHFAFGF115	
15	#14-4	Plug-on neutral ^a	CHFAFGF115PN	
20	#14-4	Pigtail	CHFAFGF120	
20	#14-4	Plug-on neutral ^a	CHFAFGF120PN	
			Combination AFCI and 5 mA people protection ground fault	Requires one ¾-inch (19.1 mm) space

^a Only for use in the Type CH plug-on neutral style of combination and non-combination loadcentres.

Plug-in circuit breakers for CH

Type CH ground fault

Type CH ground fault circuit breakers ^a

- 10,000 A interrupting capacity at 120 Vac and 120/240 Vac
- 5 mA “people protection” or 30 mA equipment protectors
- Two-pole version features common trip

Table 35. (5 mA) single- and two-pole plug-in ground fault circuit breakers

Ampere rating	Wire size range Cu/Al 60 °C or 75 °C (AWG)	Catalogue number		
		Single-pole, 120 Vac Standard Pigtail 1 per shelf carton 10 kAIC	Single-pole, 120 Vac Plug-on neutral ^b 1 per shelf carton 10 kAIC	Two-pole 120/240 Vac Standard 1 per shelf carton 10 kAIC
15	#14–6 ^c	CHFGFT115	CHFGFT115PN ^b	CH215GFT
20	#14–6 ^c	CHFGFT120	CHFGFT120PN ^b	CH220GFT
25	#14–6 ^c	CHFGFT125	—	CH225GFT
30	#14–6 ^c	CHFGFT130	CHFGFT130PN ^b	CH230GFT
35	#14–6 ^c	—	—	CH235GFT
40	#14–6 ^c	—	—	CH240GFT
45	#14–6 ^c	—	—	CH245GFT
50	#14–6 ^c	—	—	CH250GFT
60	#14–6 ^c	—	—	CH260GFT
		Requires one ¾-inch (19.1 mm) space		Requires two ¾-inch (19.1 mm) spaces

^a Not for use in Type BR loadcentres

^b Only for use in the Type CH plug-on neutral style of combination and non-combination loadcentres.

^c 60 A breaker listed for 75 °C Cu wire only.

Table 36. (30 mA) single- and two-pole plug-in ground fault circuit breaker equipment protectors

Ampere rating	Wire size range Cu/Al 60 °C or 75 °C (AWG)	Catalogue number	
		Single-pole, 120 Vac 1 per shelf carton 10 kAIC	Two-pole, 120/240 Vac 1 per shelf carton 10 kAIC
15	#14–6 ^a	CHFEP115	CH215EPD
20	#14–6 ^a	CHFEP120	CH220EPD
25	#14–6 ^a	CHFEP125	—
30	#14–6 ^a	CHFEP130	CH230EPD
40	#14–6 ^a	—	CH240EPD
50	#14–6 ^a	—	CH250EPD
60	#14–6 ^a	—	CH260EPD
		Requires one ¾-inch (19.1 mm) space	Requires two ¾-inch (19.1 mm) spaces

^a 60 A breaker listed for 75 °C Cu wire only.

Ground fault application

Single-pole ground fault circuit breakers (Type CHGFIs) are designed for use in two-wire, 120 Vac circuits. **Figure 15** shows a typical wiring configuration. Two-pole ground fault circuit breakers (Type CHGFIs) are designed for use in three-wire, 120/240 Vac circuits, 120 Vac multi-wire circuits employing common, neutral and two-wire, 240 Vac circuits obtained from a 120/240 Vac source. **Figure 16** and **Figure 17** illustrate typical wiring configurations for 120/240 Vac multi-wire circuits. **Figure 18** depicts a 240 Vac, two-wire circuit. Note the “panel neutral” conductor connects to the neutral bar, even though the neutral is not included in the load circuit. This connection is necessary to supply a 120 Vac power source to the ground fault sensing circuit. The figures are shown with a 120/240 Vac, single-phase, three-wire power source, but are also applicable to a 120/208 Vac, three-phase, four-wire power supply. For all figures the electrical operation of the Type CHGFI is not affected by the equipment ground.



Type CH two-pole GFCI circuit breaker

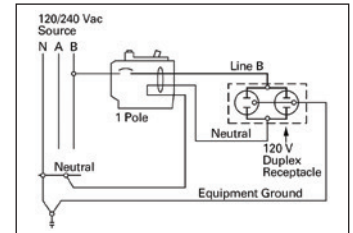

Figure 15. Single-pole single 120 V duplex receptacle application

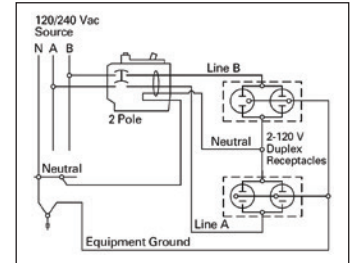

Figure 16. Two-pole 120 V multi-duplex receptacle application

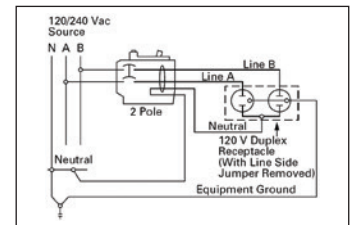

Figure 17. Two-pole 120 V duplex receptacle application

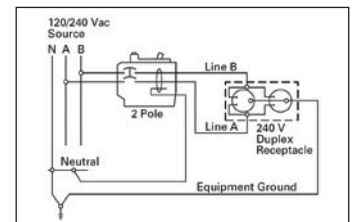

Figure 18. Two-pole 240 V duplex receptacle application

Plug-in loadcentre main circuit breakers for CH

Type CSR

Type CSR loadcentre main circuit breaker kit

- 25,000 A interrupting capacity at 120/240 Vac



CSR2150N

Product selection

Table 37. Two-pole main circuit breakers for single-phase plug-in combination loadcentres

Ampere rating	Wire size range Cu/Al 60 °C or 75 °C	Catalogue number
		Two-pole, 120/240 Vac 1 per shelf carton 25 kAIC
100	#2 AWG–300 kcmil	CSR2100N
125	#2 AWG–300 kcmil	CSR2125N
150	#2 AWG–300 kcmil	CSR2150N
200	#2 AWG–300 kcmil	CSR2200N

Plug-in loadcentres and circuit breaker accessories for CH

Type CH loadcentre and circuit breaker accessories

Table 38a. Field installation kits and parts for plug-in loadcentres and circuit breakers

Description	Ordering quantity ^a	Catalogue number
Bonding kit for bonding the neutral bus to the loadcenter	1	BONDKITP
Brown cover replacement latch—indoor loadcenters	1	LATCHPS
Retaining bracket for backfed main breaker—CH	1	CHPHD

Table 38b. Legacy Field installation kits and parts for CH loadcentres and circuit breakers

Description	Ordering quantity ^a	Catalogue number
Handle tie for single-pole Type CH circuit breakers. Joins handles on breakers mounted adjacent to each other via a moulded plastic handle cover.	1	CHHT
Handle lockoff (escutcheon mounted). Single- or two-pole Type CH circuit breakers.	1	CHPL
Handle lockoff (escutcheon mounted). Single- or two-pole Type CHGFI circuit breakers.	1	CHPLGF
Handle lockoff (escutcheon mounted). Locks the handle of main circuit breaker type CSH in the OFF of ON position.	1	MCBPL
Handle lockdog (handle mounted). Single-pole Type CH circuit breakers. Secures handle in the ON or OFF position.	1	CHLO
Subfeed kit for 125 A loadcentres. Requires two 3/4-inch (19.1 mm) spaces.	1	CHSF2125
3/4-inch (19.1 mm) filler plate kit ^a	1	CHFP ^a
Door lock for 24–60 circuit 100 and 200 A (CH)	1	TDL ^b
Trim screw kit (CH)	1	LCSS ^c
Sandalwood plastic replacement door latch	1	CHRLS
Branch circuit numbering strip kit for CH	1	CHMS ^d
Electronic breaker lockoff (escutcheon mounted) for type CHFCAF and CHFAGF		CHFAGFLOFF

^a Kit includes 25 pieces.

^b Comes with a set of keys.

^c Kit includes 25 pieces.

^d Kit includes 20 pieces.

Definitions

Handle ties: Devices used to join two similar independent single-pole circuit breakers to form a two-pole non-common trip breaker.

Handle lockoffs: Devices that use a padlock to lock a circuit breaker's handle in either the ON or OFF position.

Handle lockdogs: Devices used to secure a circuit breaker's handle in the ON or OFF position. They are not padlockable devices.

Escutcheon mounted: A semipermanent mounting to the face of the circuit breaker and secured by the loadcentre's deadfront cover.

Handle mounted: A mounting made directly to the handle of the circuit breaker by means of a set screw.

Screw mounted: A permanent mounting to the face of the circuit breaker by means of a non-removable screw.

Combination Service Entrance (main circuit breaker) single- and three-phase aluminum bus

Single-phase 120/240 Vac Type 1 (indoor) loadcentres combination service entrance

- CSA certified only (not UL approved)
- Utilize Type BAB, QBHW, QBA, DNBA, or QBGF circuit breakers as branch circuit breakers



3CBM230

Product selection

Table 39. Single-phase, three-wire 120/240 Vac aluminum bus loadcentres

Maximum ampere rating	Main breaker rating	Max. no. 1-inch spaces	Max. no. 1/2-inch spaces	Cover style	Dimensions in inches (mm)			Wire size range for main Cu/Al	Catalogue number
					H	W	D		
125	100	18	36	Flush/surface	27.00 (685.8)	14.25 (361.9)	3.75 (95.3)	#8-#1 Cu / #8-1/0 Al	CBM118 ^a
125	100	30	60	Flush/surface	34.13 (866.8)	14.25 (361.9)	3.75 (95.3)	#8-#1 Cu / #8-1/0 Al	CBM130 ^a
125	100	42	84	Flush/surface	39.00 (990.6)	14.25 (361.9)	3.75 (95.3)	#8-#1 Cu / #8-1/0 Al	CBM142 ^a
225	200	18	36	Flush/surface	34.13 (866.8)	14.25 (361.9)	3.75 (95.3)	#4-4/0	CBM218 ^b
225	200	30	60	Flush/surface	39.00 (990.6)	14.25 (361.9)	3.75 (95.3)	#4-4/0	CBM230 ^b

^a BAB2100 main circuit breaker factory installed.

^b ED2200 main circuit breaker factory installed.

Three-phase Combination service entrance 240 Vac Type 1 (indoor) loadcentres

- CSA certified only (not UL approved)
- Utilize Type BAB, QBHW, QBA, DNBA, or QBGF circuit breakers as branch circuit breakers

Table 40. Three-phase, four-wire 240 Vac maximum aluminum bus loadcentres

Maximum ampere rating	Main breaker rating	Max. no. 1-inch spaces	Max. no. 1/2-inch spaces	Cover style	Dimensions in inches (mm)			Wire size range for main Cu/Al	Catalogue number
					H	W	D		
125	100	18	36	Flush/surface	27.00 (685.8)	14.25 (361.9)	3.75 (95.3)	#8-#1 Cu / #8-1/0 Al	3CBM118 ^a
125	100	30	60	Flush/surface	34.13 (866.8)	14.25 (361.9)	3.75 (95.3)	#8-#1 Cu / #8-1/0 Al	3CBM130 ^a
125	100	42	84	Flush/surface	39.00 (990.6)	14.25 (361.9)	3.75 (95.3)	#8-#1 Cu / #8-1/0 Al	3CBM142 ^a
225	200	18	36	Flush/surface	34.13 (866.8)	14.25 (361.9)	3.75 (95.3)	#4-4/0	3CBM218 ^b
225	200	30	60	Flush/surface	39.00 (990.6)	14.25 (361.9)	3.75 (95.3)	#4-4/0	3CBM230 ^b

^a BAB3100H main circuit breaker factory installed.

^b ED3200 main circuit breaker factory installed.

Type CBM/CBL bolt-on loadcentres

Combination (main circuit breaker) single- and three-phase copper bus

Single-phase 120/240 Vac Type 1 (indoor) loadcentres combination service entrance

- CSA certified only (not UL approved)
- Utilize Type BAB, QBHW, QBA, DNBA, or QBGF circuit breakers as branch circuit breakers

Table 41. Single-phase, three-wire 120/240 Vac copper bus loadcentres

Maximum ampere rating	Main breaker rating	Max. no. 1-inch spaces	Max. no. 1/2-inch spaces	Cover style	Dimensions in inches (mm)			Wire size range for main Cu/Al	Catalogue number
					H	W	D		
125	100	18	36	Flush/surface	27.00 (685.8)	14.25 (361.9)	3.75 (95.3)	#8-#1 Cu / #8-1/0 Al	CBM118CU ^a
125	100	30	60	Flush/surface	34.13 (866.8)	14.25 (361.9)	3.75 (95.3)	#8-#1 Cu / #8-1/0 Al	CBM130CU ^a
125	100	42	84	Flush/surface	39.00 (990.6)	14.25 (361.9)	3.75 (95.3)	#8-#1 Cu / #8-1/0 Al	CBM142CU ^a
225	200	18	36	Flush/surface	34.13 (866.8)	14.25 (361.9)	3.75 (95.3)	#4-4/0	CBM218CU ^b
225	200	30	60	Flush/surface	39.00 (990.6)	14.25 (361.9)	3.75 (95.3)	#4-4/0	CBM230CU ^b

^a BAB2100 main circuit breaker factory installed.

^b ED2200 main circuit breaker factory installed.

Three-phase combination service entrance 240 Vac Type 1 (indoor) loadcentres

- CSA certified only (not UL approved)
- Utilize Type BAB, QBHW, QBA, DNBA, or QBGFT circuit breakers as branch circuit breakers

Table 42. Three-phase, four-wire 240 Vac maximum copper bus loadcentres

Maximum ampere rating	Main breaker rating	Max. no. 1-inch spaces	Max. no. 1/2-inch spaces	Cover style	Dimensions in inches (mm)			Wire size range for main Cu/Al	Catalogue number
					H	W	D		
125	100	18	36	Flush/surface	27.00 (685.8)	14.25 (361.9)	3.75 (95.3)	#8-#1 Cu / #8-1/0 Al	3CBM118CU ^a
125	100	30	60	Flush/surface	34.13 (866.8)	14.25 (361.9)	3.75 (95.3)	#8-#1 Cu / #8-1/0 Al	3CBM130CU ^a
125	100	42	84	Flush/surface	39.00 (990.6)	14.25 (361.9)	3.75 (95.3)	#8-#1 Cu / #8-1/0 Al	3CBM142CU ^a
225	200	30	60	Flush/surface	39.00 (990.6)	14.25 (361.9)	3.75 (95.3)	#4-4/0	3CBM230CU ^b

^a BAB3100H main circuit breaker factory installed.

^b ED3200 main circuit breaker factory installed.

Non-combination (main lug only) single- and three-phase aluminum bus

Single-phase 120/240 Vac Type 1 (indoor) loadcentres

- CSA certified only (not UL approved)
- Utilize Type BAB, QBHW, QBA, DNBA, or QBGF circuit breakers as branch circuit breakers



CBL130

Table 43. Single-phase, three-wire 120/240 Vac aluminum bus loadcentres

Maximum ampere rating	Max. no. 1-inch spaces	Max. no. 1/2-inch spaces	Cover style	Dimensions in inches (mm)			Wire size range for main Cu/Al	Catalogue number
				H	W	D		
125	18	36	Flush/surface	27.00 (685.8)	14.25 (361.9)	3.75 (95.3)	#6–300 MCM	CBL118
125	30	60	Flush/surface	34.13 (866.8)	14.25 (361.9)	3.75 (95.3)	#6–300 MCM	CBL130
125	42	84	Flush/surface	39.00 (990.6)	14.25 (361.9)	3.75 (95.3)	#6–300 MCM	CBL142
225	18	36	Flush/surface	27.00 (685.8)	14.25 (361.9)	3.75 (95.3)	#6–300 MCM	CBL218
225	30	60	Flush/surface	34.13 (866.8)	14.25 (361.9)	3.75 (95.3)	#6–300 MCM	CBL230
225	42	84	Flush/surface	39.00 (990.6)	14.25 (361.9)	3.75 (95.3)	#6–300 MCM	CBL242

Three-phase 240 Vac Type 1 (indoor) loadcentres

- CSA certified only (not UL approved)
- Utilize Type BAB, QBHW, QBA, DNBA, or QBGF circuit breakers as branch circuit breakers

Table 44. Three-phase, four-wire 240 Vac aluminum bus loadcentres

Maximum ampere rating	Max. no. 1-inch spaces	Max. no. 1/2-inch spaces	Cover style	Dimensions in inches (mm)			Wire size range for main Cu/Al	Catalogue number
				H	W	D		
125	18	36	Flush/surface	27.00 (685.8)	14.25 (361.9)	3.75 (95.3)	#6–300 MCM	3CBL118
125	30	60	Flush/surface	34.13 (866.8)	14.25 (361.9)	3.75 (95.3)	#6–300 MCM	3CBL130
125	42	84	Flush/surface	39.00 (990.6)	14.25 (361.9)	3.75 (95.3)	#6–300 MCM	3CBL142
225	18	36	Flush/surface	27.00 (685.8)	14.25 (361.9)	3.75 (95.3)	#6–300 MCM	3CBL218
225	30	60	Flush/surface	34.13 (866.8)	14.25 (361.9)	3.75 (95.3)	#6–300 MCM	3CBL230
225	42	84	Flush/surface	39.00 (990.6)	14.25 (361.9)	3.75 (95.3)	#6–300 MCM	3CBL242

Type CBM/CBL bolt-on loadcentres

Non-combination (main lug only) single- and three-phase copper bus

Single-phase 120/240 Vac Type 1 (indoor) loadcentres

- CSA certified only (not UL approved)
- Utilize Type BAB, QBHW, QBA, DNBA, or QBGF circuit breakers as branch circuit breakers

Table 45. Single-phase, three-wire 120/240 Vac copper bus loadcentres

Maximum ampere rating	Max. no. 1-inch spaces	Max. no. 1/2-inches spaces	Cover style	Dimensions in inches (mm)			Wire size range for main Cu/Al	Catalogue number
				H	W	D		
125	18	36	Flush/surface	27.00 (685.8)	14.25 (361.9)	3.75 (95.3)	#6–300 MCM	CBL118CU
125	30	60	Flush/surface	34.13 (866.8)	14.25 (361.9)	3.75 (95.3)	#6–300 MCM	CBL130CU
125	42	84	Flush/surface	39.00 (990.6)	14.25 (361.9)	3.75 (95.3)	#6–300 MCM	CBL142CU
225	18	36	Flush/surface	27.00 (685.8)	14.25 (361.9)	3.75 (95.3)	#6–300 MCM	CBL218CU
225	30	60	Flush/surface	34.13 (866.8)	14.25 (361.9)	3.75 (95.3)	#6–300 MCM	CBL230CU
225	42	84	Flush/surface	39.00 (990.6)	14.25 (361.9)	3.75 (95.3)	#6–300 MCM	CBL242CU

Three-phase 240 Vac Type 1 (indoor) loadcentres

- CSA certified only (not UL approved)
- Utilize Type BAB, QBHW, QBA, DNBA, or QBGF circuit breakers as branch circuit breakers

Table 46. Three-phase, four-wire 240 Vac copper bus loadcentres

Maximum ampere rating	Max. no. 1-inch spaces	Max. no. 1/2-inches spaces	Cover style	Dimensions in inches (mm)			Wire size range for main Cu/Al	Catalogue number
				H	W	D		
125	18	36	Flush/surface	27.00 (685.8)	14.25 (361.9)	3.75 (95.3)	#6–300 MCM	3CBL118CU
125	30	60	Flush/surface	34.13 (866.8)	14.25 (361.9)	3.75 (95.3)	#6–300 MCM	3CBL130CU
125	42	84	Flush/surface	39.00 (990.6)	14.25 (361.9)	3.75 (95.3)	#6–300 MCM	3CBL142CU
225	30	60	Flush/surface	34.13 (866.8)	14.25 (361.9)	3.75 (95.3)	#6–300 MCM	3CBL230CU
225	42	84	Flush/surface	39.00 (990.6)	14.25 (361.9)	3.75 (95.3)	#6–300 MCM	3CBL242CU

Type BAB and QBHW single- and multi-pole

Type BAB and QBHW

- 10,000/22,000 A interrupting capacity at 120 Vac, 120/240 Vac, and 240 Vac

Product selection

Table 47. Single- and multi-pole bolt-on circuit breakers

Ampere rating	Wire size range (Cu/Al 60 °C or 75 °C) (AWG)	Catalogue number					
		Single-pole, 120/240 Vac		Two-pole, 120/240 Vac		Three-pole, 120/240 Vac	
		10 kAIC	22 kAIC	10 kAIC	22 kAIC	10 kAIC	22 kAIC
10	#14-4	BAB1010	—	—	—	—	—
15	#14-4	BAB1015	QBHW1015	BAB2015	QBHW2015	BAB3015H	QBHW3015
20	#14-4	BAB1020	QBHW1020	BAB2020	QBHW2020	BAB3020H	QBHW3020
25	#14-4	BAB1025	—	—	—	—	—
30	#14-4	BAB1030	QBHW1030	BAB2030	QBHW2030	BAB3030H	QBHW3030
40	#14-4	BAB1040	QBHW1040	BAB2040	QBHW2040	BAB3040H	QBHW3040
50	#14-4	BAB1050	QBHW1050	BAB2050	QBHW2050	BAB3050H	QBHW3050
60	#8-1 Cu, #8-1/0 Al	BAB1060	QBHW1060	BAB2060	QBHW2060	BAB3060H	QBHW3060
70	#8-1 Cu, #8-1/0 Al	BAB1070	QBHW1070	BAB2070	QBHW2070	BAB3070H	QBHW3070
90	#8-1 Cu, #8-1/0 Al	—	—	BAB2090	QBHW2090	BAB3090H	QBHW3090
100	#8-1 Cu, #8-1/0 Al	—	—	BAB2100	QBHW2100	BAB3100H	QBHW3100
125	#8-1 Cu, #8-1/0 Al	—	—	BAB2125	QBHW2125	—	—
		Requires one 1-inch (25.4 mm) space		Requires two 1-inch (25.4 mm) spaces		Requires three 1-inch (25.4 mm) spaces	

Type BAB high intensity discharge (HID) rated

- 10,000 A interrupting capacity at 120 Vac, 120/240 Vac, and 240 Vac

Table 48. Single-pole HID rated bolt-on circuit breakers

Ampere rating	Wire size range (Cu/Al 60 °C or 75 °C) (AWG)	Catalogue number
		Single-pole, 120/240 Vac 10 kAIC
15	#14-4	BAB1015D
20	#14-4	BAB1020D
		Requires one 1-inch (25.4 mm) space

Table 49. Single-pole bolt-on fire alarm breakers

Ampere rating	Configuration	Catalogue number
		Single-pole, 120/240 Vac 10 per shelf carton 10 kAIC
15	Branch fire alarm	BABF1015
20	Branch fire alarm	BABF1020
	Compact body breaker	Requires one 1-inch (25.4 mm) space

Bolt-on circuit breakers for CBM/CBL

Type QBA arc fault circuit interrupter and DNBA duplex

Type QBA Arc fault circuit interrupter circuit breakers

- 10,000/22,000 A interrupting capacity at 120 Vac 120/240 Vac, and 240 Vac

Table 50. Single- and two-pole bolt-on FIRE-GUARD AFCI circuit breakers

Ampere rating	Configuration	Catalogue number		Wire size range (Cu/Al 60 °C or 75 °C) (AWG)
		Single-pole 120/240 Vac		
		10 kAIC	22 kAIC	
15	Combination	QB1015CAF	QBH1015CAF	#14–4
15	Dual With GFCI 5mA	QB1015AFGF	QBH1015AFGF	#14–4
20	Combination	QB1020CAF	QBH1020CAF	#14–4
20	Dual With GFCI 5mA	QB1020AFGF	QBH1020AFGF	#14–4
		Requires one 1-inch (25.4 mm) space	Requires one 1-inch (25.4 mm) space	

Type DNBA duplex circuit breakers

- 10,000 A interrupting capacity at 120/240 Vac
- Provides 2 single-pole circuits in one 1-inch space

Table 51. Twin plug-in circuit breakers

Ampere rating	Wire size range (Cu/Al 60 °C or 75 °C) (AWG)	Catalogue number
		Single-pole, 120/240 Vac 10 per shelf carton
15–15	#14–4	DNBA1515
20–20	#14–4	DNBA2020
30–30	#14–4	DNBA3030
Requires one 1-inch (25.4 mm) space		

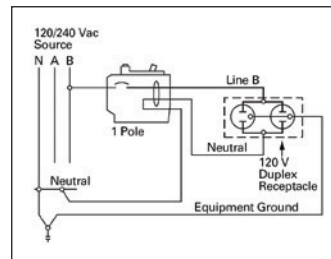

Figure 19. Single-pole, single 120 V load application sourced by 120/240 Vac

Type QBGF and QBGFEP ground fault

Type QBGF and QBGFEP ground fault circuit breakers

- 10,000/22,000 A interrupting capacity at 120 Vac and 120/240 Vac
- 5 mA “people protection” or 30 mA equipment protectors
- Two-pole version features common trip

Table 52. (5 mA) single- and two-pole bolt-on ground fault circuit breakers

Ampere rating	Wire size range Cu/Al 60 °C or 75 °C (AWG)	Catalogue number	
		Single-pole, 120 Vac 1 per shelf carton 10 kAIC	Two-pole, 120/240 Vac 1 per shelf carton 10 kAIC
15	#14–10 Cu, #12–10 Al	QB1015GF	QBGFT2015
20	#14–10 Cu, #12–10 Al	QB1020GF	QBGFT2020
30	#10 Cu, #8 Al	QB1030GF	QBGFT2030
40	#8 Cu, #8–6 Al	QBGFT1040	QBGFT2040
50	#8–6 Cu, #6–4 Al	—	QBGFT2050
		Requires one 1-inch (25.4 mm) space	Requires two 1-inch (25.4 mm) spaces

Table 53. (30 mA) single- and two-pole bolt-on ground fault circuit breaker equipment protectors

Ampere rating	Wire size range Cu/Al 60 °C or 75 °C (AWG)	Catalogue number			
		Single-pole, 120 Vac 1 per shelf carton		Two-pole, 120/240 Vac 1 per shelf carton	
		10 kAIC	22 kAIC	10 kAIC	22 kAIC
15	#14–4	QB1015EP	QBH1015EP	QBGFEP2015	QBHGFEP2015
20	#14–4	QB1020EP	QBH1020EP	QBGFEP2020	QBHGFEP2020
25	#14–4	QB1025EP	QBH1025EP	QBGFEP2025	QBHGFEP2025
30	#14–4	QB1030EP	QBH1030EP	QBGFEP2030	QBHGFEP2030
		Requires one 1-inch (25.4 mm) space	Requires one 1-inch (25.4 mm) space	Requires two 1-inch (25.4 mm) spaces	Requires two 1-inch (25.4 mm) spaces

Bolt-on loadcentre and circuit breaker accessories

Bolt-on accessories

Table 54. Field installation kits and parts for bolt-on loadcentres and circuit breakers

Description	Ordering quantity	Catalogue number
Handle lockoff single-pole of Type DNBA duplex circuit breakers (package of 10)	1	BRDL1-10
Handle lockoff Type BQL circuit breakers	1	BQL-10
Handle lockoff Type BAB and QBHW circuit breakers	1	QL123PL
Handle lockdog single-pole Type BAB and QBHW circuit breakers	1	QL1NPL
Handle lockdog two- and three-pole Type BAB and QBHW circuit breakers	1	QL23NPL
Filler plates 1-inch space (package of 24)	1	BRFP
Subfeed lug 100 A (for main lug panel style)	1	CBSF100
Subfeed lug 225 A (for main lug panel style)	1	CBSF225
Subfeed lug kit 100 A three-phase (for main lug panel style)	1	3CBSF100
Subfeed lug kit 225 A three-phase (for main lug panel style)	1	3CBSF225
Circuit breaker directory card 1–42 (package of 50)	1	DIRCARD42
Circuit breaker directory sleeve (package of 25)	1	DIRSLEEVE
Loadcentre door lock	1	TDL
Isolated ground kit	1	ISGRD

Definitions

Handle lockoffs: Devices that use a padlock to lock a circuit breaker's handle in either the ON or OFF position.

Handle lockdogs: Devices used to secure a circuit breaker's handle in the ON or OFF position. They are not padlockable devices.

Product description

A transfer switch panel is a device that is mounted next to or incorporated within the loadcentre (distribution panel) in the home or small business. The transfer switch panel is used in conjunction with an emergency generator (usually supplied by others) and serves the purpose of turning selected circuits on and off during a power outage. The transfer switch panel allows the owner to start up a generator and then restore power to critical circuits when utility power is not available.

The owner designates which circuits are critical such as their refrigerator, furnace, and certain lighting loads. Sometimes called emergency power panels, emergency generator panels, gen. panels, transfer switches or emergency panels; transfer switch panels provide the homeowner or small business owner with a safe and easy way to continue using essential electrical loads when utility power is not available.

Application description

Transfer switch panels are most often used in residential, agricultural and light commercial applications. Comfort and safety are key concerns of many homeowners who are dependent on an uninterrupted supply of electricity.

The increase in our dependence on power is due in part to the popularity of home business and in-home care. In addition, various rural and urban regions in North America experience periodic power outages due to extreme weather conditions such as ice and snowstorms, heat waves, tornadoes or hurricanes. Regions such as Pacific, Atlantic, and Central are the strongest markets for portable generators and transfer switch panels.

Features, functions, and benefits

Eaton offers two unique manual transfer switch emergency power solutions.

- Manual transfer switches or a generator sub-panel
- Combination service entrance loadcentre with generator sub-panel

IMPORTANT

BEFORE INSTALLATION, CONSULT APPROPRIATE ELECTRICAL CODES. INSTALLATION INFORMATION IS INCLUDED IN THE CARTON.

Manual transfer switches/generator panels

- Main utility and emergency (generator) breaker factory installed
- Available in 30 and 60 A design
- Utility breaker and generator breakers are mechanically interlocked to protect equipment and personnel by preventing dangerous dual-source feeding
- Critical loads permanently connected to allow for quick and convenient switching from utility power to stand-by generator power
- Designed for switched neutral applications. Can be reconfigured in field for non-switched neutral applications
- Sturdy and reliable 125 A rated aluminum bus design
- Type BR/DNPL branch breakers sold separately
- Ideal for new and retrofit installations
- EEMAC 1 indoor enclosure design
- Standards and certifications
- CSA approved

Product specifications

- 10,000 AIC rating
- Switching devices must be circuit breakers
- Transfer switch panel must be supplied with neutral and ground

Combination service entrance loadcentre generator panel CBRPM236GEN

- Single enclosure (EEMAC 1) to house both loadcentre and generator breakers
- Factory installed main breakers
- Available in 200 A designs
- Utility and emergency transfer switch breaker factory installed
- Utility breaker and generator breakers are mechanically interlocked to protect equipment and personnel by preventing dangerous dual-source feeding
- Critical loads permanently connected to allow for quick and convenient switching from utility power to stand-by generator power
- Designed for switched neutral applications. Can be reconfigured in field for non-switched neutral applications
- Type BR/DNPL branch breakers sold separately
- Ideal for new and retrofit installations
- EEMAC 1 indoor enclosure design

Standards and certifications

- CSA approved

Product specifications

- 25,000 AIC rating for CBRPM236GEN
- Switching devices must be circuit breakers
- Transfer switch panel must be supplied with neutral and ground

Manual transfer switches/generator panels

Product selection

Table 55. Manual transfer switches/generator panels

Bus rating (A)	Generator breaker (A)	Switched neutral	Enclosure rating	Max. total branch circuits (1-inch/½-inch)	Inlet receptacle type	Height branch circuits in inches (mm)	Width in inches (mm)	Depth in inches (mm)	Catalogue number
125	30	Yes	EEMAC 1	6/12	—	16.75 (425.5)	14.38 (365.1)	3.88 (98.4)	CBRPL112G3
125	60	Yes	EEMAC 1	6/12	—	16.75 (425.5)	14.38 (365.1)	3.88 (98.4)	CBRPL112G6
125	60	Yes	EEMAC 1	14/28	—	21.00 (533.4)	14.38 (365.1)	3.88 (98.4)	CBRPL120G6
125	60	Yes	EEMAC 1	24/48	—	29.13 (739.8)	14.38 (365.1)	3.88 (98.4)	CBRPL130G6

Table 56. Combination service entrance loadcentre generator panel

Bus rating (A)	Loadcentre main breaker (A)	Max. total branch circuits (1-inch/½-inch)	Generator breaker (A)	Switched neutral	Max. generator branch circuits	Height in inches (mm)	Width in inches (mm)	Depth in inches (mm)	Catalogue number
200	200	36/72	60	Yes	6/12	49.00 (1244.6)	14.38 (365.1)	3.88 (98.4)	CBRPM236GEN

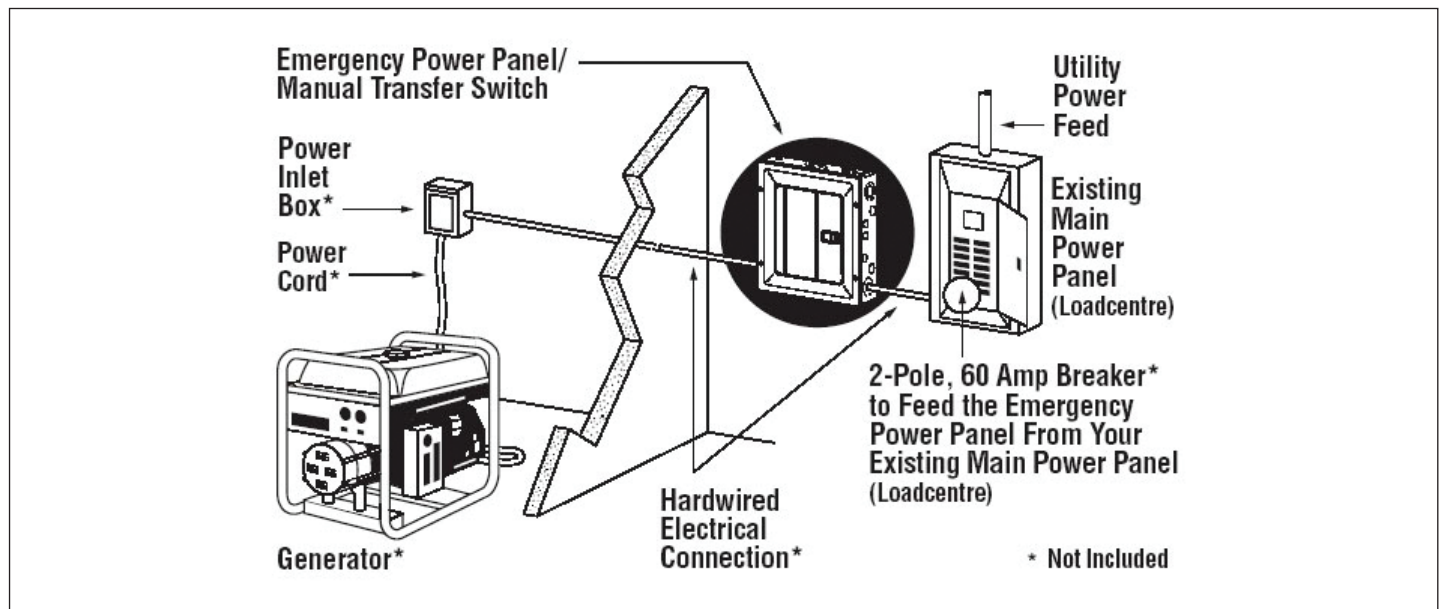

Figure 20. Typical installation diagram

Notes:

Combination service entrance loadcentre generator panels come complete with an integrated emergency generator panel.

Combination service entrance loadcentre generator panels come complete with factory installed utility feeder breaker for emergency generator panel section.

* Not Included

Single-phase, three-wire 120/240 Vac ground fault circuit interrupter spa panels

- Factory assembled, prewired, tested, and ready to install
- Two-pole 5 mA “people protection” Type CH ground fault circuit interrupter circuit breaker
- Two additional one-pole circuits available
- Test button provides a means of confirming proper GFCI circuit breaker operation
- 10,000 A interrupting capacity
- 120/240 Vac single-phase, three-wire
- Pre-installed neutral and ground bars
- Type 3R enclosure good for indoor or outdoor mounting
- Interior deadfront provides protection from energized parts
- Padlockable cover provides added security and safety
- Audible alarm option field installable
- Can be used as a disconnect to turn the spa pump on and off
- Main lug connections will accommodate a single #14–1/0 AWG conductor ^a

^a Refer to **page 34** for Type CH ground fault circuit breaker accepted load conductor sizes.



Product description

CEC Rule 68-086 (1) and (6) requires that a ground fault circuit interrupter, of a Class A Type, be installed not closer than 3 m (10 ft) to a pool or spa water. In cases where a spa is installed some distance from your main loadcentre it is often more convenient to locate this protection device in a small panel closer to the spa. Excessive cable lengths required to connect directly back to a protection device in your main loadcentre may be more susceptible to insulation breakage and result in nuisance tripping of the breaker. The reduced distance the owner must travel to reset a tripped circuit breaker in a localized spa panel may also be an excellent selling point for the owner.

Product selection

Table 57. Two-pole plug-in Type 3R spa panels

Breaker amperage (A)	Breaker type	Enclosure style	Audible alarm	Height in inches (mm)	Width in inches (mm)	Depth in inches (mm)	Catalogue number
30	CH	Indoor/outdoor Type 3R ^a	N	12.00 (304.8)	6.88 (174.6)	4.50 (114.3)	CH30SPAST
40	CH	Indoor/outdoor Type 3R ^a	N	12.00 (304.8)	6.88 (174.6)	4.50 (114.3)	CH40SPAST
50	CH	Indoor/outdoor Type 3R ^a	N	12.00 (304.8)	6.88 (174.6)	4.50 (114.3)	CH50SPAST
60	CH	Indoor/outdoor Type 3R ^a	N	12.00 (304.8)	6.88 (174.6)	4.50 (114.3)	CH60SPAST

^a Outdoor loadcentres accommodate Type DS conduit hubs. Hubs not included. See **page 15** for selection.

Table 58. Spa panel accessories

Description	Catalogue number
Field installable audible alarm kit (breaker and panel not included)	CHSPALARM

Note: CEC Rule 68-086 (1) and (6) requires that a ground fault circuit interrupter, of a Class A type, be installed not closer than 3 m (10 ft) to a pool or spa water.

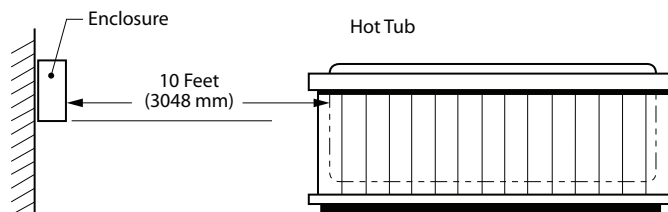

Check national and local codes for compliance.

Surge suppression products

Stage 1 and Stage 1 Type 2

Residential surge suppression products

- Stage 1 surge protection as well as Type 1 and Type 2 offering
- Convenient in-panel mount unit for Type BR loadcentres
- Knockout mount or surface mount CHSP design. DIN mount adapter for Type 1
- Limited lifetime warranty on CHSPT2ULTRA
- Dovetail clip together cable surge accessories for CHSPT2 design
- Flush mount kit for CHSPT2 design knockout mounting
- Type 2 surge suppression product designed to meet CSA C22.2 No.269-2 and UL 1449 3rd edition standard, cULus Listed No. N 024005



Product description

Today's homes are filled with increasing quantities of devices containing sensitive electronic components. These devices can easily be damaged by common power surges also some times called line transients, spikes, or voltage impulses. Lighting strikes, utility grid switching, other users on the powerline, and internal surges from air conditioners and powers tools are the most common sources these damaging line transients. To protect your investment it is recommended that a surge suppression device be installed. Surge protection can be broken into two stages. Stage 1 protection is primary protection for your service entrance. This protection is typically installed inside or adjacent to a home's service entrance distribution panel. Stage 2 protection is secondary protection or protection at the point of use. For proper surge protection both a stage 1 and stage 2 device must be installed. Eaton offers surge products to provide stage 1 protection to your sensitive equipment as well as both Type 1 and Type 2 surge devices that meet the latest CSA C22.2 No. 269 and UL 1449 3rd standard. We also offer surge protection devices for cable/satellite and Ethernet protection since surges are not isolated to the utility lines only.

Product selection
Combination of Surge Protection and Surge/Breaker Protection
 Ideal for applications with limited space in the panel.

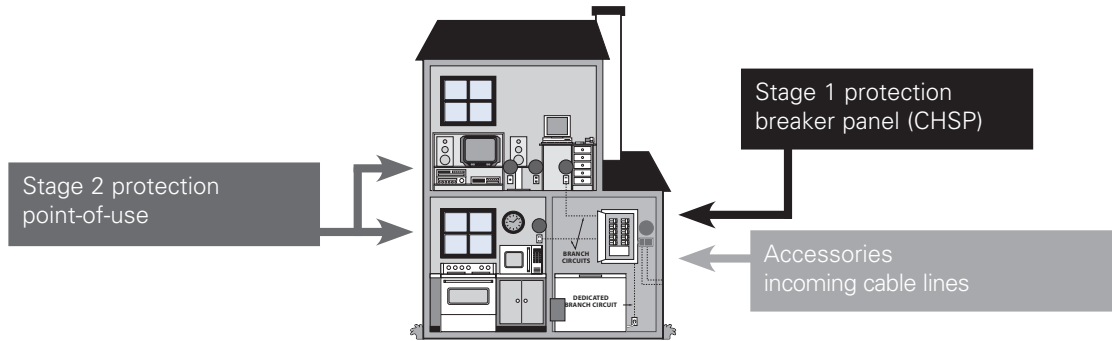

Table 59. Stage 1 Type 2 (point-of-service entrance) residential surge suppression products for Type BR/CH plug-in loadcentres

Connection	Voltage (Vac)	Phase	Frequency (Hz)	Maximum continuous operating voltage (V) ^a	Voltage protection rating ^b	Nominal discharge current (A) ^c	Short circuit current rating (A) ^d	Surge current capacity per phase (A) ^e	Catalogue number
Plug-on to loadcentre bus in Type BR loadcentres	120/240	Single	50/60	200 Line-to-Neutral (L-N) 400 Line-to-Line (L-L)	600 V L-N 1000 V L-L	3000	10,000	18,000	BRSURGE Surge only
Plug-on to loadcentre bus in Type BR loadcentres	120/240	Single	50/60	150 Line-to-Neutral (L-N) 300 Line-to-Line (L-L)	600 V L-N 1000 V L-L	10,000	10,000	36,000	BR230SUR Surge and Breaker
Plug-on to loadcentre bus in Type BR loadcentres	120/240	Single	50/60	150 Line-to-Neutral (L-N) 300 Line-to-Line (L-L)	600 V L-N 1000 V L-L	10,000	10,000	36,000	BR250SUR Surge and Breaker
Plug-on to loadcentre bus in Type CH loadcentres	120/240	Single	50/60	150 Line-to-Neutral (L-N) 300 Line-to-Line (L-L)	600 V L-N 1000 V L-L	10,000	10,000	36,000	CH230SUR Surge and Breaker
Plug-on to loadcentre bus in Type CH loadcentres	120/240	Single	50/60	150 Line-to-Neutral (L-N) 300 Line-to-Line (L-L)	600 V L-N 1000V L-L	10,000	10,000	36,000	CH250SUR Surge and breaker

a Maximum continuous operating voltage that may be applied to the device per mode.
 b Voltage protection rating is the measured limiting voltage after a surge event.
 c Nominal discharge current is the current that the device can withstand for 15 impulses.
 d The amount of current the product can withstand under short circuit conditions.
 e The maximum one time surge current rating per phase.

Table 60. Stage 1 Type 2 (point-of-service entrance) residential surge suppression products for any loadcentre

Connection	Voltage (Vac)	Phase	Frequency (Hz)	Maximum continuous operating voltage (V) ^a	Voltage protection rating ^b	Nominal discharge current (A) ^c	Short circuit current rating (A) ^d	Surge current capacity per phase (A) ^e	Catalogue number
Can be attached to the outside of any manufacturer's loadcentre (breaker box). This product should be connected on the load side of the loadcentre main service disconnect through a dedicated circuit breaker (follow CEC guidelines).	120/240	Single	60	150 Line-to-Neutral (L-N)	600 V L-N	5,000	22,000	36,000	CHSPT2SURGE
	120/240	Single	60	300 Line-to-Line (L-L)	1000 V L-L 800 V N-G	20,000 ^f	22,000	108,000	CHSPT2ULTRA
	120/240	Single	60		600 V L-G	20,000 ^f	22,000	108,000	CHSPT22PACK

^a Maximum continuous operating voltage that may be applied to the device per mode.

^b Voltage protection rating is the measured limiting voltage after a surge event.

^c Nominal discharge current is the current that the device can withstand for 15 impulses.

^d The amount of current the product can withstand under short circuit conditions.

^e The maximum one time surge current rating per phase.

^f When used with a 50 A two-pole breaker, 10 kA when used with a 15 A two-pole breaker.

^g CHSPT22PACK contains one each of CHSPT2ULTRA, CHSPCABLE.

Accessories



CHSPCABLE

Table 61. Residential surge suppression accessories

Description	Application	Product warranty	Connected equipment warranty	Maximum surge current (A) ^a	Catalogue number
SurgeCable™	Cable TV, satellite, cable modems (2 lines)	Lifetime	\$10,000	20,000	CHSPCABLE
Flushmount Kit™	Flush mount kit for finished wall installations	—	N/A	N/A	CHSPFMKIT

^a Maximum surge rating is the sum of all modes of protection.

Installation

CHSP and accessories can be mounted on the side, top, or bottom of a circuit breaker panel.

Note: CHSP SURGE, ULTRA or the 2-pack can be used interchangeably depending on protection required.

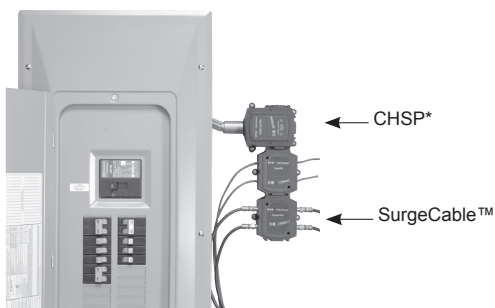

Street lighting panels

In-pole



Service entrance approved street and roadway lighting panels

- Compact in-pole panel fits into lighting pole hand well
- Pedestal mount 3R (rain-tight) street lighting panels feature a Eaton loadcentre housed in a Pencil enclosure

Product description

Since January 1, 2003 the Ontario Electric Safety Code requires that all roadway lighting shall meet the service entrance requirements of Rule 30-1002. Eaton has developed several designs of approved products to suit the various installation points (pole mounted, within an enclosure etc.). All products are CSA approved.

In-pole street lighting panels

- Fits into most pole manufacturers' hand well
- Service entrance approved
- 3R rain-tight
- Pre-wired
- Single- or two-pole, 22 kA, 50 A versions
- Removable mounting plates accommodate multiple hand wells
- CSA approved
- Approximate dimensions 9 x 2.25 x 4 inches
- Line power connections via #6 AWG conductor pigtail
- Load power connections via #14 AWG conductor pigtail
- #6 AWG conductor pigtail provided for daisy chaining of additional light poles

Product selection

Table 62. In-pole street lighting panels

Description	Voltage (Vac)	Main circuit breaker	Interrupting (kAIC)	Catalogue number
120 Vac in-pole compact street lighting panel	120	Single-pole 15 A	22	1SL150PCO
120 Vac in-pole compact street lightning panel	120	Single-pole 30 A	22	1SL300PCO
120 Vac in-pole compact street lighting panel	120	Single-pole 50 A	22	1SL500PCO
240 Vac in-pole compact street lighting panel	120/240	Two-pole 15 A	22	2SL150PCO
240 Vac in-pole compact street lighting panel	120/240	Two-pole 30 A	22	2SL300PCO
240 Vac in-pole compact street lighting panel	120/240	Two-pole 50 A	22	2SL500PCO

Pedestal

Pedestal mounted street lighting panels

- Lightweight, stand-alone units mount on the ground
- Polyethylene Pencil enclosure provides rugged, low profile, rain-tight assembly
- Penta head and key lock provision for security
- Vented or non-vented enclosure styles
- Two extra 1-inch breaker locations accept Type BR and DNPL plug-in circuit breakers for additional lighting loads
- Service entrance approved
- 3R rain-tight
- Single- or two-pole 22 kA, 50, 60, or 70 A versions
- CSA approved
- Underground duct or direct burial cable accessible



Product selection

Table 63. Pedestal mount non-vented street lighting panels

Voltage (Vac)	Main circuit breaker	Interrupting (kAIC)	Branch circuits (1-inch/½-inch)	Extension	Main circuit breaker wire size range (Cu/Al 60 °C or 75 °C) (AWG)	Catalogue number
120	Single-pole 50 A	22	2/4	No	#14–4	1SL502NV
120	Single-pole 60 A	22	2/4	No	#4–1/0	1SL602NV
120	Single-pole 70 A	22	2/4	No	#4–1/0	1SL702NV
120/240	Two-pole 50 A	22	2/4	No	#14–4	2SL502NV
120/240	Two-pole 60 A	22	2/4	No	#4–1/0	2SL602NV
120/240	Two-pole 70 A	22	2/4	No	#4–1/0	2SL702NV
120	Single-pole 50 A	22	2/4	Yes	#14–4	1SL502NVE
120	Single-pole 60 A	22	2/4	Yes	#4–1/0	1SL602NVE
120	Single-pole 70 A	22	2/4	Yes	#4–1/0	1SL702NVE
120/240	Two-pole 50 A	22	2/4	Yes	#14–4	2SL502NVE
120/240	Two-pole 60 A	22	2/4	Yes	#4–1/0	2SL602NVE
120/240	Two-pole 70 A	22	2/4	Yes	#4–1/0	2SL702NVE

Table 64. Pedestal mount vented street lighting panels

Voltage (Vac)	Main circuit breaker	Interrupting (kAIC)	Branch circuits (1-inch/½-inch)	Extension	Main circuit breaker wire size range (Cu/Al 60 °C or 75 °C) (AWG)	Catalogue number
120	Single-pole 50 A	22	2/4	Yes	#14–4	1SL502VE
120	Single-pole 60 A	22	2/4	Yes	#4–1/0	1SL602VE
120	Single-pole 70 A	22	2/4	Yes	#4–1/0	1SL702VE
120/240	Two-pole 50 A	22	2/4	Yes	#14–4	2SL502VE
120/240	Two-pole 60 A	22	2/4	Yes	#4–1/0	2SL602VE
120/240	Two-pole 70 A	22	2/4	Yes	#4–1/0	2SL702VE

Combined loadcentre and meter socket

Combined loadcentre and meter socket

- 4 Jaw, 100 and 200 A, 120/240 V, 22 kAIC
- Service entrance rated with 100 or 200 A main circuit breaker included
- Suitable for underground or overhead service entrance
- Meter socket mechanical lugs accommodate #6–250 MCM Cu/Al line conductors and (2) #6–300 MCM Cu/Al neutral conductors
- Loadcentre mechanical lugs load and neutral (2) #6–300 MCM Cu/Al
- CSR circuit breaker mechanical load lugs #2–300 MCM
- Suitable for overhead or underground service entrance
- Suitable applications include farming, temporary service, construction sites, trailers, and mobile homes
- Hub opening and plate included. Hubs ordered separately (use DS type hubs)
- 3R enclosure
- CSA approved



Product selection

Table 65. Combined loadcentre and meter socket

Enclosure	Voltage (V)	Amperage (A)	Interrupting (kAIC)	Entrance type	Branch circuits (1-inch/½-inch)	Weight in lb (kg)	Dimensions in inches (mm)	Catalogue number
Indoor/outdoor Type 3R	120/240	100	22	Underground/overhead	8/16	36.5 (16.6)	28.38 x 14.44 x 5.38 (974.7 x 366.7 x 136.5)	RCPM108M
Indoor/outdoor Type 3R	120/240	200	22	Underground/overhead	8/16	36.5 (16.6)	28.38 x 14.44 x 5.38 (974.7 x 366.7 x 136.5)	RCPM208M

Table 66 Knockout legend

Location	Knockout size in inches (mm)	Quantity
Bottom end wall	0.50 (12.7)	7
Bottom end wall	0.50, 0.75 (12.7, 19.1)	4
Bottom end wall	0.50, 0.75, 1.00 (12.7, 19.1, 25.4)	1
Bottom end wall	1.00, 1.25, 1.50, 2.00 (25.4, 31.8, 38.1, 50.8)	1
Bottom end wall	1.25, 1.50, 2.00, 2.50, 3.00 (31.8, 38.1, 50.8, 63.5, 76.2)	1
Top end wall	Provision for Hub ^a (e.g. DS200H2, DS250H2, DS300H2)	2
Backplane	1.25, 1.50, 2.00, 2.50 (31.8, 38.1, 50.8, 63.5)	1
Backplane	1.25, 1.50, 2.00 (31.8, 38.1, 50.8)	1
Right sidewall	1.25, 1.50, 2.00, 2.50 (31.8, 38.1, 50.8, 63.5)	1

^a Accommodate Type DS conduit hubs. Hubs not included. See **page 15** for selection.

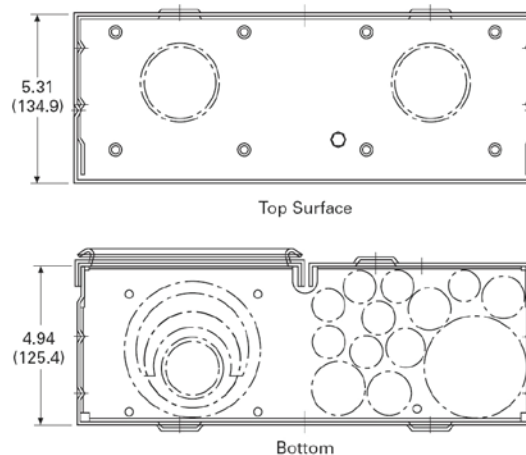

Metered temporary ground fault power panel

Metered temporary power panel with ground fault protection

- Combination loadcentre, meter socket, and electrical outlets for temporary work site installations
- Single-phase, three-wire
- 4 jaw, 100 or 200 A, 120/240 V, 22 kAIC meter socket
- Suitable for overhead or underground service entrance
- CSA approved for service entrance
- 3R enclosure suitable for outdoor installations
- Two different receptacle combinations 6X20A and 2X30A or 10X20A
- Hub opening and plate included. Hubs ordered separately (uses DS type hubs)
- Meter socket mechanical lugs accommodate #6–250 MCM Cu/Al line conductors and #6–300 MCM Cu/Al neutral conductors



Product selection

Table 67. Metered temporary ground fault protected power panel

Enclosure	Voltage (V)	Amperage (A)	Interrupting (kAIC)	Entrance Type	20 A receptacles	30 A receptacles	Dimensions in inches (mm)	Catalogue number
Indoor/outdoor Type 3R	120/240	100	22	Underground/overhead	6	2	34.38 x 22.00 x 5.38 (873.1 x 558.8 x 136.5)	RCPM1GF6H
Indoor/outdoor Type 3R	120/240	100	22	Underground/overhead	10	0	34.38 x 22.00 x 5.38 (873.1 x 558.8 x 136.5)	RCPM1GF10
Indoor/outdoor Type 3R	120/240	200	22	Underground/overhead	6	2	34.38 x 22.00 x 5.38 (873.1 x 558.8 x 136.5)	RCPM2GF6H
Indoor/outdoor Type 3R	120/240	200	22	Underground/overhead	10	0	34.38 x 22.00 x 5.38 (873.1 x 558.8 x 136.5)	RCPM2GF10

Table 68. Knockout legend

Catalogue number	Knockout size (inches)	Quantity
Bottom endwall	0.50, 0.75	6
Bottom endwall	0.50, 0.75, 1.00, 1.25	2
Bottom endwall	1.00, 1.25, 1.50, 2.00, 2.50	1
Bottom endwall	1.00, 1.25, 1.50, 2.00, 2.50, 3.00	1
Top endwall	Provision for Hub a (e.g. DS200H2, DS250H2, DS300H2)	1

a Accommodate Type DS conduit hubs. Hubs not included. See **page 13** for selection.



Top Surface

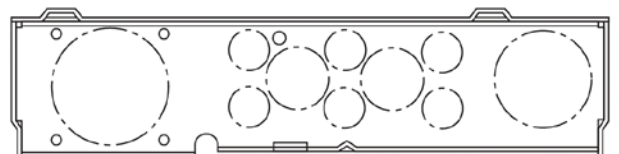

Bottom

Mini-power centres



Mini-power centres

- Distribution transformer, breaker protection, and loadcentre all in one compact package
- Primary and secondary breaker protection via factory installed EHD or FDB type MCCBs
- 18, 25, or 35 kAIC interrupting capacity versions available on select models through special order
- Two styles of interior; one for plug-in or bolt-on (breakers not included)
- Loadcentre accommodates up to 24 feeder circuit breakers (breakers purchased separately)
- Aluminum chassis on plug-in type, copper chassis on bolt-on type, standard ground bar, and enclosure grounded neutral bar
- All live parts are enclosed
- Hinged, padlockable cover prevents removal
- Enclosure includes grounding terminal
- Type 3R enclosure with baked polymer polyester powder coating is good for indoor or outdoor mounting
- Optional Type 3R, 316 grade stainless steel enclosure
- Main circuit breaker barrier provides CSA approval for service entrance applications
- Electrical grade aluminum windings standard on the distribution transformer (copper optional)
- Copper windings standard on bolt-on style units
- 185 °C insulation system
- 115 °C winding temperature rise
- Full capacity taps (FCBN) 2–5%
- Resin encapsulated, core-coil assembly (cores grounded with copper lead)

Product description

Contemporary electrical distribution systems are required to do more in less space while at the same time being cost-effective. Eaton provides a solution to these requirements with the proven mini-power centre. It occupies considerably less space and can save up to 31 percent of the installation costs normally required when individual components are used. The solution is possible because a mini-power centre combines three individual components into one NEMA Type 3R enclosure: a main breaker, an encapsulated Type EP or EPT dry-type transformer, and a secondary distribution loadcentre with main breaker. Interconnecting wiring is completed at the factory. A mini-power centre is delivered ready for installation. It's suitable for use as service entrance equipment, too. Mini-power centres are used wherever there is a 480 V or 600 V distribution system and loads requiring 208Y/120 V three-phase or 120/240 V single-phase.

Typical installations include:

- Industrial plant assembly lines
- Plant expansions
- Commercial buildings
- Test equipment
- Temporary power at construction sites
- Sewage disposal plants
- Warehouses
- Car washes
- Parking lots

The mini-power centre saves you space, time, and money. A mini-power centre installation takes up only 42% of the space taken up by a typical installation. A typical installation being comprised of a separately mounted distribution transformer, disconnect switch, loadcentre and all associated wiring and connectors.

The installation costs of a mini-power centre are 31% less when compared with the same typical installation.

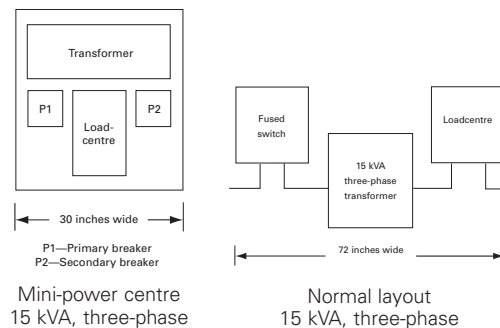

Time to perform task(s) a (hours)

Installation	15 kVA		25 kVA	
	Typical installation	Mini-power centre installation	Typical installation	Mini-power centre installation
Switch and fuse mounting	5	0	5	0
Transformer layout (remove knockout, etc.)	16	16	24	24
Fasten transformer to wall	4	0	4	0
Layout loadcentre, mount and connect source	4	4	6	4
Total hours	29	20	39	28
% time saved by using a eaton mini-power centre		31%		28%

Plug-in

Table 69. Single-phase plug-in mini-power centres

kVA	Primary and secondary voltage (V)	Catalogue number ^a	Main circuit breaker ^b		Maximum number of feeder circuit breakers			Maximum amperage	Dimensions in inches (mm) ^c			Weight in lb (kg)
			Primary	Secondary	Single-pole	Two-pole	Three-pole		Height	Width	Depth	
3	480 to 120/240	P48G11S03P	EHD2015	BR215	8	4	—	12	27.05 (699.0)	12.60 (320.0)	9.70 (245.0)	105 (47)
5	480 to 120/240	P48G11S05P	EHD2020	BR225	12	6	—	20	29.50 (749.0)	12.60 (320.0)	9.70 (245.0)	105 (47)
7.5	480 to 120/240	P48G11S07P	EHD2030	BR230	12	6	—	30	29.50 (749.0)	12.60 (320.0)	9.70 (245.0)	125 (56)
10	480 to 120/240	P48G11S10P	EHD2040	BR250	12	6	—	40	38.20 (970.0)	13.50 (343.0)	11.80 (300.0)	177 (80)
15	480 to 120/240	P48G11S15P	EHD2060	BR270	20	10	—	60	38.20 (970.0)	13.50 (343.0)	11.80 (300.0)	212 (96)
25	480 to 120/240	P48G11S25P	EHD2100	BR2125	26	13	—	100	43.90 (1115.0)	16.40 (417.0)	11.80 (300.0)	373 (169)
5	600 to 120/240	P60G11S05P	FDB2015	BR225	12	6	—	20	29.50 (749.0)	12.60 (320.0)	14.60 (370.0)	105 (47)
7.5	600 to 120/240	P60G11S07P	FDB2030	BR230	12	6	—	30	29.50 (749.0)	12.60 (320.0)	9.70 (245.0)	125 (56)
10	600 to 120/240	P60G11S10P	FDB2040	BR250	12	6	—	40	38.20 (970.0)	13.50 (343.0)	9.70 (245.0)	177 (80)
15	600 to 120/240	P60G11S15P	FDB2060	BR270	20	10	—	60	38.20 (970.0)	13.50 (343.0)	11.80 (300.0)	212 (96)
25	600 to 120/240	P60G11S25P	FDB2100	BR2125	26	13	—	100	43.90 (1115.0)	16.40 (417.0)	14.60 (370.0)	373 (169)

a For a primary main circuit breaker interrupting capacity greater than 10 kAIC, add the following suffixes to the catalogue number; for 18 kAIC, add "F"; for 25 kAIC, add "H"; and for 35 kAIC, add "C".

b Main circuit breakers fixed only. No substitutes.

c Not for construction purposes.

Note: For price and delivery on a unit with copper transformer windings or 316 grade stainless steel enclosure, contact your local Eaton sales representative or our Customer Service centre at 1-800-268-3578. Feeder circuit breakers not included. Uses Eaton Type BR circuit breakers.

Table 70. Three-phase plug-in mini-power centres

kVA	Primary and secondary voltage (V)	Catalogue number ^a	Main circuit breaker ^b		Maximum number of feeder circuit breakers			Maximum amperage	Dimensions in inches (mm) ^c			Weight in lb (kg)
			Primary	Secondary	Single-pole	Two-pole	Three-pole		Height	Width	Depth	
15	480 to 120/208	P48G28T15P	EHD3040	BR350	18	9	6	40	36.10 (917.0)	28.80 (732.0)	9.70 (245.0)	320 (145)
22.5	480 to 120/208	P48G28T21P	EHD3070	BR370	18	9	6	60	40.90 (1039.0)	29.90 (759.0)	11.80 (300.0)	565 (256)
30	480 to 120/208	P48G28T30P	EHD3090	BR3100	24	12	8	80	41.90 (1064.0)	29.90 (759.0)	13.60 (346.0)	635 (288)
15	600 to 120/208	P60G28T15P	FDB3030	BR350	18	9	6	40	36.10 (917.0)	28.80 (732.0)	9.40 (238.0)	320 (145)
22.5	600 to 120/208	P60G28T21P	FDB3050	BR370	18	9	6	60	40.90 (1039.0)	29.90 (759.0)	5650 (256.0)	565 (256)
30	600 to 120/208	P60G28T30P	FDB3070	BR3100	24	12	8	80	41.90 (1064.0)	29.90 (759.0)	6350 (288.0)	635 (288)

a For a primary main circuit breaker interrupting capacity greater than 10 kAIC, add the following suffixes to the catalogue number; for 18 kAIC add "F", for 25 kAIC add "H", and for 35 kAIC add "C".

b Main circuit breakers fixed only. No substitutes.

c Not for construction purposes.

Note: For price and delivery on a unit with copper transformer windings or 316 grade stainless steel enclosure, contact your local Eaton sales representative or our Customer Service centre at 1-800-268-3578. Feeder circuit breakers not included. Uses Eaton Type BR circuit breakers.

Bolt-on mini-power centres

Bolt-on

Table 71. Single-phase bolt-on mini-power centres

kVA	Primary and secondary voltage (V)	Catalogue number	Main circuit breaker ^a		Maximum number of feeder circuit breakers ^{bc}			Maximum amperage	Dimensions in inches (mm) ^d			Weight in lb (kg)
			Primary	Secondary	Single-pole	Two-pole	Three-pole		Height	Width	Depth	
3	480 to 120/240	P48G11S03CUB	EHD2015L	BAB2015	12	6	—	12	33.20 (845.0)	12.60 (320.0)	9.70 (245.0)	105 (47)
5	480 to 120/240	P48G11S05CUB	EHD2020L	BAB2025	18	9	—	20	36.10 (918.0)	12.60 (320.0)	9.70 (245.0)	110 (50)
7.5	480 to 120/240	P48G11S07CUB	EHD2030L	BAB2030	18	9	—	30	36.10 (918.0)	12.60 (320.0)	9.70 (245.0)	110 (50)
10	480 to 120/240	P48G11S10CUB	EHD2040L	BAB2050	18	9	—	40	40.90 (1038.0)	13.50 (343.0)	11.80 (300.0)	180 (82)
15	480 to 120/240	P48G11S15CUB	EHD2060L	BAB2070	24	12	—	60	43.90 (1115.0)	15.00 (380.0)	11.80 (300.0)	215 (98)
25	480 to 120/240	P48G11S25CUB	EHD2100L	BAB2125	30	15	—	100	43.40 (1102.0)	20.40 (518.0)	14.60 (370.0)	385 (175)
3	600 to 120/240	P60G11S03CUB	FDB2015L	BAB2015	12	6	—	12	33.20 (845.0)	12.60 (320.0)	9.70 (245.0)	105 (47)
5	600 to 120/240	P60G11S05CUB	FDB2020L	BAB2025	18	9	—	20	36.10 (918.0)	12.60 (320.0)	9.70 (245.0)	110 (50)
7.5	600 to 120/240	P60G11S07CUB	FDB2030L	BAB2030	18	9	—	30	36.10 (918.0)	12.60 (320.0)	9.70 (245.0)	110 (50)
10	600 to 120/240	P60G11S10CUB	FDB2040L	BAB2050	18	9	—	40	40.90 (1038.0)	13.50 (343.0)	11.80 (300.0)	180 (82)
15	600 to 120/240	P60G11S15CUB	FDB2060L	BAB2070	24	12	—	60	43.90 (1115.0)	15.00 (380.0)	11.80 (300.0)	215 (98)
25	600 to 120/240	P60G11S25CUB	FDB2100L	BAB2125	30	15	—	100	43.40 (1102.0)	20.40 (518.0)	14.60 (370.0)	385 (175)

a Main circuit breakers fixed only. No substitutes.

b Feeder circuit breakers not included. Uses Eaton Type BAB circuit breakers.

c Combinations can be selected.

d Not for construction purposes.

Table 72. Three-phase bolt-on mini-power centres

kVA	Primary and secondary voltage (V)	Catalogue number	Main circuit breaker ^a		Maximum number of feeder circuit breakers ^{bc}			Maximum amperage	Dimensions in inches (mm) ^d			Weight in lb (kg)
			Primary	Secondary	Single-pole	Two-pole	Three-pole		Height	Width	Depth	
15	480 to 120/208	P48G28T15CUB	EHD3040L	BAB3050H	18	9	6	40	36.10 (917.0)	28.70 (730.0)	9.40 (238.0)	320 (148)
22.5	480 to 120/208	P48G28T21CUB	EHD3070L	BAB3070H	18	9	6	60	40.90 (1038.0)	29.90 (759.0)	13.60 (346.0)	565 (257)
30	480 to 120/208	P48G28T30CUB	EHD3090L	BAB3100H	24	12	8	80	41.90 (1063.0)	29.90 (759.0)	13.60 (346.0)	635 (288)
15	600 to 120/208	P60G28T15CUB	FDB3030	BAB3050H	18	9	6	40	36.10 (917.0)	28.70 (730.0)	9.40 (238.0)	320 (148)
22.5	600 to 120/208	P60G28T21CUB	FDB3050	BAB3070H	18	9	6	60	40.90 (1038.0)	29.90 (759.0)	13.60 (346.0)	565 (257)
30	600 to 120/208	P60G28T30CUB	FDB3070	BAB3100H	24	12	8	80	41.90 (1063.0)	29.90 (759.0)	13.60 (346.0)	635 (288)

a Main circuit breakers fixed only. No substitutes.

b Feeder circuit breakers not included. Uses Eaton Type BAB circuit breakers.

c Combinations can be selected.

d Not for construction purposes.

Residential fuse panel inserts

- Convenient and economical option to completely replacing an entire fuse panel assembly
- Original fuse panel tub and wiring remains in place and only the fuse panel trim and interior is removed and replaced
- 16 and 24 circuit breaker interiors designed to fit any manufacturers' fuse panel or discontinued design circuit breaker panel
- Custom trim and door oversized to ensure fit with existing tub
- Circuit breaker interior replacement eliminates the possibility of improperly sized amperage protection
- No more loose fuses causing arcing and damage to the panel or wiring
- CSA certified to mount into any existing box under file LL264-222
- Can be mounted in any orientation as defined by the existing fuse panel tub orientation
- Accepts plug-in Type BR, DNPL, or GFCB circuit breakers (circuit breakers sold separately, refer to **page 17** to **page 20** for selection)
- Trim comes complete with hinged door, non-locking spring latch, clear plastic card holder, and circuit directory card
- Tin plated aluminum bus bars

^a Not for use as service entrance equipment.

Product description

Fuses and fuse panels were designed decades ago, to prevent the overload of circuit wiring that could lead to fires caused by overloaded electrical circuit connections and/or short circuits. Records show however, that problems of fire and smoke inhalation are the more serious causes of death or injury.

Since early 1960's, technology has allowed a tremendous increase in the number and use of appliances, tools, and control systems, many of which are automatically controlled and cycle on and off. We now know that a cycling load will actually cause a plug (screw-on-type) fuse to loosen in its holder (that explains why you can always find one or two fuses that can be tightened a quarter turn). Loose connections such as these develop heat, and in turn increase the risk of fire.

Small overloads can be absorbed by the margin of safety built into CSA certified devices. However, prolonged overloads or loose fuses will cause arcing and ultimately, melting of the connections in either the panel or wiring, wherever the weakest link may be.

Eaton has designed a low cost method of replacing fuse panels with modern circuit breaker panels. This method eliminates the need for cutting, re-plastering and repainting the walls around the old panel.

Another risk with the old fuse panel design was the ease with which incorrect fuses could be used or changed without realization of the risks involved.

To eliminate these potential hazards Eaton has a new circuit breaker interior and trim kit that will quickly upgrade the existing installation to today's electrical standards and needs. An average upgrade takes one hour and thus creates the minimum of inconvenience to the homeowner/occupant.

Sample specification

- Supply and install a new circuit breaker interior to replace existing plug fuse panel interior or out of date circuit breaker interior in each apartment or condominium
- Interior to be 16 or 24 circuit, rated 100 A and 120/240 V, designed in a single row breaker arrangement for fitting into existing recessed electrical panels
- Supply and install new trim and door assembly slightly larger then discarded fuse trim to minimize any requirements for patching or repainting
- Bus bars shall be tin plated aluminum suitable for plug-in circuit breakers
- Supply and install a trim and door assembly with latch, to protect the circuit breaker toggle handles
- Inserts must be CSA certified for mounting in any position, for ease in connecting to existing wiring
- Install circuit breakers with ratings as indicated in specifications or drawings
- Interiors to be mounted with directions template and hardware supplied by Eaton
- Inserts, trim and door assembly and circuit breakers, shall be manufactured by Eaton
- Provide a circuit identification card, mounted under clear plastic on the inside of the door

Residential fuse panel inserts

Insert interiors

Residential fuse panel insert interiors

- 100 A single-phase, three-wire 120/240 Vac
- 16 and 24 circuit breaker capacity ^a
- CSA certified to mount into any existing box under file LL264-222
- Accepts plug-in type BR and DNPL circuit breakers ^{ab}
- Tin plated aluminum bus bars
- Neutral available with 16 or 24 Cu/Al terminals
- Main and neutral lugs located at the same end
- All terminals accept #14–3 AWG cabling

^a Filler plates for unused fuse panel insert circuit breaker installation locations can be ordered as BRFP (package of 24).

^b Refer to **page 17** to **page 20** for plug-in circuit breaker selection.

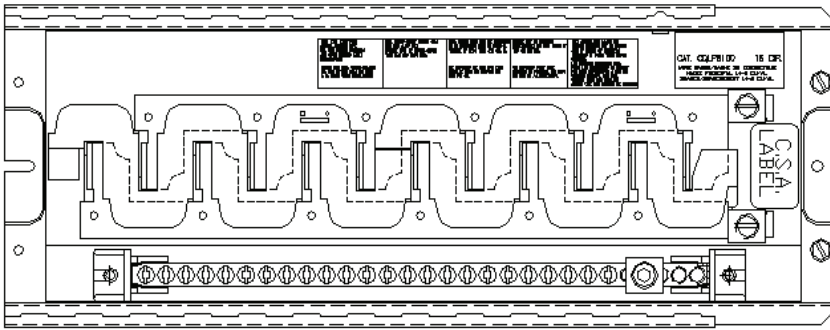
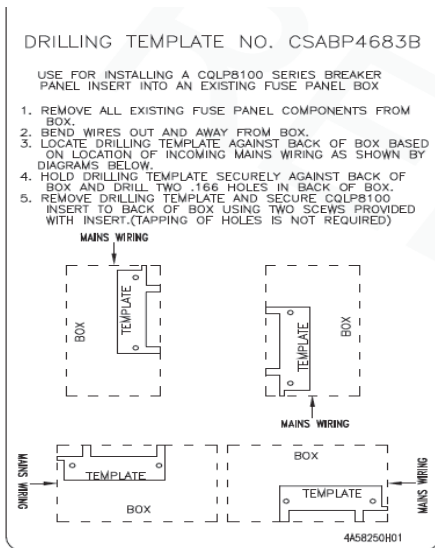

Table 73. Three-wire 120/240 Vac fuse panel insert interiors

Amperage rating (A)	Voltage (V)	Number of installable circuit breakers		Bus material	Neutral material	Wire size range Cu/Al	Catalogue number	Drilling template catalogue number ^a
		1-inch spaces	1/2-inch spaces					
100	120/240	8	16	Aluminum	Aluminum	#14–3 AWG	CQLP8100	CSABP4683B
100	120/240	12	24	Aluminum	Aluminum	#14–3 AWG	CQLP12100	CSABP4734B

^a We suggest the use of templates to ensure proper sizing for installation.



Trims

Residential fuse panel insert trims

- Doors are die formed with sloping sides and rounded corners and permanently mounted to the trim
- Semi concealed hinges ^a
- Includes circuit directory card and self adhesive clear plastic directory holder
- Painted ASA61 light grey baked on enamel
- Mounting hardware included ^b
- Trims are custom sized larger than the existing trim and door
- Trim mounting holes located to line up with existing box holes ^c

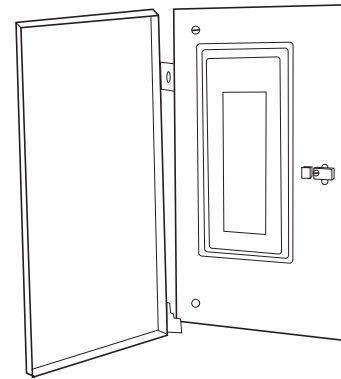

^a If the main service entrance is bottom entry, the door hinges left. If it is top entry, then the door hinges right.

^b The hardware supplied will accommodate boxes that are mounted up to 1/2-inch too deep or equal to 3-1/2 inches net depth.

^c Measure the existing box holes locations as they may be part of the end walls, side walls, or tapped into a box flange.

Table 74. Fuse panel insert trims

Original manufacturer	Fuse panel catalogue number	Box dimensions (inches)			Replacement trim catalogue number	Trim size (inches)		Replacement interior catalogue number	Trim mounting holes (inches)	
		Height	Width	Depth		Height	Width		Height	Width
Amalgamated	4112	16-1/8	8-1/2	2-15/16	QLPT16D	18-1/4	9-3/4	CQLP8100	16-1/6	4
Amalgamated	4116	19-1/2	8-1/2	2-15/16	QLPT19D	20-7/8	9-3/4	CQLP8100	18-11/16	4
Amalgamated	4120	22-7/8	8-1/2	2-15/16	QLPT22AD	25	10-1/2	CQLP12100 ^a	22-1/4	6
Amalgamated	4208	16-1/8	8-1/2	2-15/16	QLPT16AD	18-1/4	10-5/16	CQLP8100	15-1/2	6
Amalgamated	4212	19-1/2	8-1/2	2-15/16	QLPT20AD	20-7/8	9-3/4	CQLP8100	18-11/16	6
Amalgamated	4216	22-7/8	8-1/2	2-15/16	QLPT22AD	25	10-1/2	CQLP12100 ^a	22-1/4	6
Amalgamated	4220	24-1/8	8-1/2	2-15/16	QLPT24D	26	9-3/4	CQLP12100 ^a	23-13/16	4
Amalgamated	4312	22-7/8	8-1/2	2-15/16	QLPT22AD	25	10-1/2	CQLP12100 ^a	22-1/4	6
CEB	NHP10-636-3 ^b	24	10	3	QLPT24LD	26	12	CQLP12100 ^a	23-13/16	4
CEB	NHP6-60 ^c	14	7-3/4	3	QLPT14D	16	9-3/4	CQLP8100	13-3/16	4
CEB	NHP12-60	20	7-3/4	3	QLPT20D	21-3/4	9-3/4	CQLP12100 ^a	19-9/16	4
CEB	NHP12-633	23	7-3/4	3	QLPT24D	26	9-3/4	CQLP12100 ^a	23-13/16	4
CEB	NHP4-632	16-1/4	7-3/4	3	QLPT16D	18-1/4	9-3/4	CQLP8100	16-1/6	4
CEB	NHP6-633	20	7-3/4	3	QLPT19D	20-7/8	9-3/4	CQLP8100	18-11/16	4
CEB	NHP6-636-4	24	7-3/4	3	QLPT24D	26	9-3/4	CQLP12100 ^a	23-13/16	4
CEB	NHP8-60	16-1/8	7-3/4	3	QLPT16D	18-1/4	9-3/4	CQLP8100	16-1/6	4
CEB	NHP8-635-3	23	7-3/4	3	QLPT24D	26	9-3/4	CQLP12100 ^a	23-13/16	4
Taylor (Crouse-Hinds)	NHP6-30-60	21	7-3/8	3	QLPT20D	21-3/4	9-3/4	CQLP12100 ^a	19-9/16	4
Taylor (Crouse-Hinds)	NHP20-1231	24-1/2	9-1/2	3	QLPT24D	26	9-3/4	CQLP12100 ^a	23-13/16	4
Taylor (Crouse-Hinds)	NHP20-0821-6	24-1/2	9-1/2	3	QLPT24D	26	9-3/4	CQLP12100 ^a	23-13/16	4
Taylor (Crouse-Hinds)	NHP12B-1000-2	17-1/8	9-1/2	3	QLPT16AD	18-1/8	10-5/16	CQLP8100	15-1/2	6
Taylor (Crouse-Hinds)	NHP10-0401-4	17-1/8	9-1/2	3	QLPT16AD	18-1/8	10-5/16	CQLP8100	15-1/2	6
Taylor (Crouse-Hinds)	NHP10-0601-2	17-1/8	9-1/2	3	QLPT16AD	18-1/8	10-5/16	CQLP8100	15-1/2	6
Taylor (Crouse-Hinds)	NHP10-0611	17-1/8	9-1/2	3	QLPT16AD	18-1/8	10-5/16	CQLP8100	15-1/2	6
Taylor (Crouse-Hinds)	NHP10-0801	17-1/8	9-1/2	3	QLPT16AD	18-1/8	10-5/16	CQLP8100	15-1/2	6
Taylor (Crouse-Hinds)	NHP12-0811	19-1/4	9-1/2	3	QLPT22AD	25	10-1/2	CQLP12100 ^a	22-1/4	6
Taylor (Crouse-Hinds)	NHP14-0801-4	19-1/4	9-1/2	3	QLPT22AD	25	10-1/2	CQLP12100 ^a	22-1/4	6
Taylor (Crouse-Hinds)	NHP14-0621-2	19-1/4	9-1/2	3	QLPT22AD	25	10-1/2	CQLP12100 ^a	22-1/4	6

^a Panel insert CQLP8100 can also be used with this size trim.

^b For box sizes either 26 inches or 27-1/2 inches high, no insert or trim is available.

^c For box size 14" only

Replacement classic circuit breakers

Bolt-on Type BQL single-, multi-pole, Duplex, and Quadplex

Type BQL ^a

- 10,000/22,000 A interrupting capacity at 120/240 Vac
- Captive line screw included (#2 Robertson/Slot)

^a HACR rated.

Product selection

Table 75. Single- and multi-pole bolt-on classic replacement circuit breakers

Ampere rating	Wire size range (Cu/Al 60 °C or 75 °C) (AWG)	Catalogue number					
		Single-pole, 120/240 Vac		Two-pole, 120/240 Vac	Three-pole, 120/240 Vac		
		10 kAIC	22 kAIC	10 kAIC	10 kAIC	22 kAIC	
15	#14–8	BQL15 ^a	HBQL15	BQL215	BQL315	HBQL315	
20	#14–8	BQL20 ^a	HBQL20	BQL220	BQL320	—	
25	#14–8	BQL25	HBQL25	BQL225	—	—	
30	#14–8	BQL30	HBQL30	BQL230	BQL330	HBQL330	
40	#14–4	BQL40	HBQL40	BQL240	BQL340	—	
50	#14–4	BQL50	HBQL50	BQL250	BQL350	HBQL350	
60	#8–2/0	BQL60	HBQL60	BQL260	BQL360	HBQL360	
70	#8–2/0	—	—	BQL270	BQL370	HBQL370	
90	#8–2/0	—	—	BQL290	BQL390	HBQL390	
100	#8–2/0	—	—	BQL2100	BQL3100	HBQL3100	
125	#8–2/0	—	—	BQL2125	—	—	
135	#8–2/0	—	—	BQL2135	—	—	
		Requires one 1-inch (25.4 mm) space		Requires two 1-inch (25.4 mm) spaces		Requires three 1-inch (25.4 mm) spaces	

^a Switching duty rated (SWD).

Type BQL Duplex and Quadplex ^a

- 10,000 A interrupting capacity at 120/240 Vac
- Captive line screw included (#2 Robertson/Slot)

^a HACR rated.

Table 76. Type BQL Duplex and Quadplex bolt-on classic replacement circuit breakers

Duplex		Quadplex independent trip						Wire size range (Cu/Al 60 °C or 75 °C) (AWG)	
Two single-pole circuits		Two single-pole circuits and one two-pole circuit				Two two-pole circuits			
Ampere rating		Ampere rating				Ampere rating			
		120 Vac	120/240 Vac	120 Vac	120/240 Vac				
120 Vac	Catalogue number	Outer left (single-pole)	Centre (two-pole)	Outer right (single-pole)	Catalogue number	Outer left and right (two-pole)	Centre (two-pole)	Catalogue number	
15–15	BQLT15 ^a	15	15	15	BQLT15215	15	15	BQLT215215	#14–4
20–20	BQLT20 ^a	15	20	15	BQLT15220	20	20	BQLT220220	#14–4
30–30	BQLT30 ^a	15	25	15	BQLT15225	15	30	BQLT215230	#14–4
—	—	15	30	15	BQLT15230	15	40	BQLT215240	#14–4
—	—	15	40	15	BQLT15240	—	—	—	#14–4
Requires one 1-inch (25.4 mm) space		Requires two 1-inch (25.4 mm) spaces				Requires two 1-inch (25.4 mm) spaces			

^a Switching duty rated (SWD).

Bolt-on Type BQL ground fault and moulded case switches

Type BQL ground fault circuit breakers

- 10,000 A interrupting capacity at 120/240 Vac
- 5 mA “people protection”

Product selection

5 mA single- and two-pole bolt-on ground fault circuit breakers are no longer able to be manufactured due to change in UL standard to require all GF devices to “Self Test.”

Type BQL non-automatic circuit breakers (moulded case switches)

- 240 Vac
- Two- and three-pole versions

Table 77. Two- and three-pole bolt-on non-automatic circuit breakers (moulded case switches)

Ampere rating	Wire size range Cu/Al 60 °C or 75 °C (AWG)	Catalogue number	
		Two-pole, 240 Vac	Three-pole, 240 Vac
60	#8-1 Cu #8-1/0 Al	BQL260NA Requires two 1-inch (25.4 mm) spaces	BQL360NA Requires three 1-inch (25.4 mm) spaces

Note: When the Canadian Electrical Code requires the use of an unfused disconnect device as a local isolation switch, then a circuit breaker enclosure may be used in conjunction with a moulded case switch (a.k.a. a non-automatic circuit breaker). For example, with an air conditioning unit, the protective device for these applications is located upstream.

Replacement classic circuit breakers

Bolt-on Type QBH single- and multi-pole.

Type QBH

- 120/240 Vac
- 3/4-inch form factor
- Designed to fit the classic CEB, Sylvania or Commander Electric design bolt-on loadcentres
- Suitable for loadcentres, lighting and distribution panelboards, and meter centres
- Silver Tungsten contacts with wiping action to prevent carbon buildup on the contact surface
- Handle provides clear indication of ON/OFF/TRIPPED position
- Quick-make / quick-break mechanism provides tease-proof operation
- Internal common trip mechanism on two-pole circuit breakers
- Each breaker is electronically calibrated for 40 °C
- Compression moulded housing and handle for durability and service

Table 78. Single- and two-pole bolt-on classic replacement circuit breakers

Ampere rating	Wire size range 60 °C or 75 °C (AWG)	Catalogue number	
		Single-pole, 120 Vac 10 kAIC	Two-pole, 120/240 Vac 10 kAIC
15	#14–10 Cu, #12–10 Al	QBH15	QBH215
20	#14–10 Cu, #12–10 Al	QBH20	QBH220
25	#14–10 Cu, #12–10 Al	QBH25	QBH225
30	#10–2 Cu, #10–1 Al	QBH30	QBH230
40	#10–2 Cu, #10–1 Al	QBH40	QBH240
50	#10–2 Cu, #10–1 Al	QBH50	QBH250
60	#10–2 Cu, #10–1 Al	QBH60	QBH260
70	#10–2 Cu, #10–1 Al	—	QBH270
90	#10–2 Cu, #10–1 Al	—	QBH290
100	#10–2 Cu, #10–1 Al	—	QBH2100
125	#10–1 Cu	—	QBH2125
		Requires one 3/4-inch (19.1 mm) space	Requires two 3/4-inch (19.1 mm) spaces

Plug-in Type BJ two- and three-pole

Type BJ ^a

- Main circuit breakers for classic Westinghouse NovaLine loadcentres
- 10,000 A interrupting capacity at 120/240 Vac

^a BJ breakers are also approved as branch circuit breakers on CPM/CPL panels 200 A and greater.

Table 79. Type BJ two- and three-pole plug-in classic replacement circuit breakers

Ampere rating	Wire size range Cu/Al 60 °C or 75 °C (AWG)	Catalogue number	
		Two-pole, 120/240 Vac 1 per shelf carton 10 kAIC	Three-pole, 120/240 Vac 1 per shelf carton 10 kAIC
125	#2–300 MCM	BJ2125	BJ3125
150	#2–300 MCM	BJ2150	BJ3150
175	#2–300 MCM	BJ2175	BJ3175
200	#2–300 MCM	BJ2200	BJ3200
		Requires four 1-inch (25.4 mm) spaces ^a	Requires six 1-inch (25.4 mm) spaces ^b

^a When mounted, the Type BJ circuit breakers span both sides of the bus bar occupying an equivalent number of pole spaces on both the left and right side of the loadcentre. For example a two-pole Type BJ circuit breaker occupies 2 pole spaces on the left and the same number of spaces on the right thus requiring four 1-inch spaces.

^b When mounted, the Type BJ circuit breakers span both sides of the bus bar occupying an equivalent number of pole spaces on both the left and right side of the loadcentre. For example a three-pole Type BJ circuit breaker occupies 3 pole spaces on the left and the same number of spaces on the right thus requiring six 1-inch spaces.

Pressure switches

- Ensures smooth delivery of water into your home
- Commercial, residential, or agricultural applications
- Can be used on all types of pumps
- Pressure ratings 20–40 PSI, 30–50 PSI, and 40–60 PSI
- Adjustable cut-in and cut-out pressure
- Easy installation
- CSA certified and UL listed
- Pulsation plug models prevent pump cycling due to water surges
- Low pressure cut-off models prevent pump burn out due to lack of well water (10 PSI below turn on pressure)
- 3-year product warranty



Pressure switch

Product selection

Table 80. Pressure switches

Description	Enclosure style	Catalogue number
20–40 PSI pressure switch	NEMA 1	CHWPS2040D
20–40 PSI pressure switch with pulsation plug	NEMA 1	CHWPS2040DP
20–40 PSI pressure switch with low pressure cut-off	NEMA 1	CHWPS2040DL
30–50 PSI pressure switch	NEMA 1	CHWPS3050D
30–50 PSI pressure switch with low pressure cut-off	NEMA 1	CHWPS3050DL
40–60 PSI pressure switch	NEMA 1	CHWPS4060D

Table 81. Pressure switch ratings

Phase	Voltage (AC)	Amperage	Horsepower
Single	115	20	1.5
Handle tie	230	12	2.0

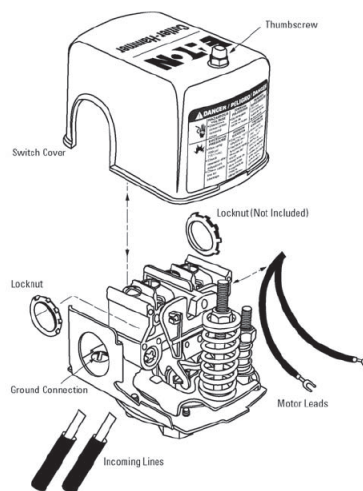

Table 82. Pressure switch cross-reference

Description	Catalogue number				
	Eaton	Square DT	Flotec ^T	Water Ace ^T	Furnas ^T
20–40 PSI pressure switch	CHWPS2040D	9013FSG2J20	—	15767A510	69WA4Z2040
20–40 PSI pressure switch with pulsation plug	CHWPS2040DP	9013FSG2J20P	—	—	69WA4Z2040B
20–40 PSI pressure switch with low pressure cut-off	CHWPS2040DL	9013FSG2J20M4	—	—	69WEC
30–50 PSI pressure switch	CHWPS3050D	9013FSG2J21	TC2151	15760A501	69WA4
30–50 PSI pressure switch with low pressure cut-off	CHWPS3050DL	9013FSG2J21M4	FP217-1140	19180A501	—
40–60 PSI pressure switch	CHWPS4060D	9013FSG2J24	TC2153	—	69WA4Z4060

Notes:

- CSA is a registered trademark of the Canadian Standards Association
- UL is a federally registered trademark of Underwriters Laboratories Inc.
- NEMA is the registered trademark and service mark of the National Electrical Manufacturers Association
- Square D is a federally registered trademark of Schneider Electric
- Flotec is a registered trademark of Flotec
- Furnas is a registered trademark of Siemens Energy and Automation, Inc.
- Water Ace is a registered trademark of the Pentair Pump Group

Index

1SL150PCO 50	3CCPL103 12	BAB2100 41	BQL230 60
1SL300PCO 50	3CPL112 12	BAB2125 41	BQL240 60
1SL500PCO 50	3CPL124 12	BAB3015H 41	BQL250 60
1SL502NV 51	3CPL130 12	BAB3020H 41	BQL260 60
1SL502NVE 51	3CPL136 12	BAB3030H 41	BQL260NA 61
1SL502VE 51	3CPL218 12	BAB3040H 41	BQL270 60
1SL602NV 51	3CPL224 12	BAB3050H 41	BQL290 60
1SL602NVE 51	3CPL230 12	BAB3060H 41	BQL315 60
1SL602VE 51	3CPL242 12	BAB3070H 41	BQL320 60
1SL702NV 51	3CPL442 12	BAB3090H 41	BQL330 60
1SL702NVE 51	3CPM112 8	BAB3100H 41	BQL340 60
1SL702VE 51	3CPM130 8	BABF1015 41	BQL350 60
2SL150PCO 50	3CPM230 8	BHGW-10 24	BQL360 60
2SL300PCO 50	3CPM442 8	BHLW1-10 24	BQL360NA 61
2SL500PCO 50	48INT125B 25	BHLW2-10 24	BQL370 60
2SL502NV 51	52-3125-5 15	BHLW-10 24	BQL390 60
2SL502NVE 51	52-3125-6 15	BJ2125 63	BQL2100 60
2SL502VE 51	816INT125B 25	BJ2150 63	BQL2125 60
2SL602NV 51	1224INT125B 25	BJ2175 63	BQL2135 60
2SL602NVE 51	1624INT125B 25	BJ2200 63	BQL3100 60
2SL602VE 51	2024INT125B 25	BJ3125 63	BQLT15 60
2SL702NV 51	2424INT125B 25	BJ3150 63	BQLT20 60
2SL702NVE 51	4112 59	BJ3175 63	BQLT30 60
2SL702VE 51	4116 59	BJ3200 63	BQLT15215 60
3BRS225 15	4120 59	BP2 18	BQLT15220 60
3BRS400 15	4208 59	BP4 18	BQLT15225 60
3CBL118 39	4212 59	BP16 18	BQLT15230 60
3CBL118CU 40	4216 59	BP18 18	BQLT15240 60
3CBL130 39	4220 59	BP21 18	BQLT215215 60
3CBL130CU 40	4312 59	BP23 18	BQLT215230 60
3CBL142 39	BAB1010 41	BP24 18	BQLT215240 60
3CBL142CU 40	BAB1015 41	BP27 18	BQLT220220 60
3CBL218 39	BAB1015D 41	BP31 18	BR115 17
3CBL230 39	BAB1020 41	BP32 18	BR115E 21
3CBL230CU 40	BAB1020D 41	BP41 18	BR120 17
3CBL242 39	BAB1025 41	BP54 18	BR120E 21
3CBL242CU 40	BAB1030 41	BP3110C 15	BR125 17
3CBM118 37	BAB1040 41	BQHT-10 24	BR125E 21
3CBM118CU 38	BAB1050 41	BQL-10 44	BR130 17
3CBM130 37	BAB1060 41	BQL15 60	BR130E 21
3CBM130CU 38	BAB1070 41	BQL20 60	BR135 17
3CBM142 37	BAB2015 41	BQL25 60	BR135E 21
3CBM142CU 38	BAB2020 41	BQL30 60	BR140 17
3CBM218 37	BAB2030 41	BQL40 60	BR140E 21
3CBM230 37	BAB2040 41	BQL50 60	BR150 17
3CBM230CU 38	BAB2050 41	BQL60 60	BR150E 21
3CBM242 37	BAB2060 41	BQL215 60	BR160 17
3CBSF100 44	BAB2070 41	BQL220 60	BR160E 21
3CBSF225 44	BAB2090 41	BQL225 60	BR170 17

Residential and light commercial products

BR170E 21	BR390E 21	BRH270 17	BRN120AFC 19
BR215 17	BR2100 17	BRH270E 21	BRN120DFC 19
BR215E 21	BR2100E 21	BRH280 17	BRN120EP 20
BR220 17	BR2100NA 22	BRH280E 21	BRN120GFC 20
BR220E 21	BR2125 17	BRH290 17	BRN125EP 20
BR225 17	BR3100 17	BRH290E 21	BRN125GFC 20
BR225E 21	BR3100E 21	BRH315 17	BRN130EP 20
BR230 17	BRCAFLOFF 24	BRH315E 21	BRN130GFC 20
BR230E 21	BRDL1-10 24, 44	BRH320 17	BRP115AFC 19
BR235 17	BRF115 19	BRH320E 21	BRP115DFC 19
BR235E 21	BRF120 19	BRH325 17	BRP120AFC 19
BR240 17	BRFP 15, 44, 58	BRH325E 21	BRP120DFC 19
BR240E 21	BRH115 17	BRH330 17	BRQLW-10 24
BR245 17	BRH115E 21	BRH330E 21	BRS225 15
BR245E 21	BRH120 17	BRH335 17	BRS400 15
BR250 17	BRH120E 21	BRH335E 21	BRSF125 15
BR250E 21	BRH125 17	BRH340 17	BRSURGE 48
BR250NA 22	BRH125E 21	BRH340E 21	CBL118 39
BR260 17	BRH130 17	BRH345 17	CBL118CU 40
BR260E 21	BRH130E 21	BRH345E 21	CBL130 39
BR260NA 22	BRH135 17	BRH350 17	CBL130CU 40
BR270 17	BRH135E 21	BRH350E 21	CBL142 39
BR270E 21	BRH140 17	BRH360 17	CBL142CU 40
BR280 17	BRH140E 21	BRH360E 21	CBL218 39
BR280E 21	BRH145 17	BRH370 17	CBL218CU 40
BR290 17	BRH145E 21	BRH370E 21	CBL230 39
BR290E 21	BRH150 17	BRH380 17	CBL230CU 40
BR315 17	BRH150E 21	BRH380E 21	CBL242 39
BR315E 21	BRH160 17	BRH390 17	CBL242CU 40
BR320 17	BRH160E 21	BRH390E 21	CBM118 37
BR320E 21	BRH170 17	BRH2100 17	CBM118CU 38
BR325 17	BRH170E 21	BRH2100E 21	CBM130 37
BR325E 21	BRH215 17	BRH3100 17	CBM130CU 38
BR330 17	BRH215E 21	BRH3100E 21	CBM142 37
BR330E 21	BRH220 17	BRHN115AF 19	CBM142CU 38
BR335 17	BRH220E 21	BRHN115GF 20	CBM218 37
BR335E 21	BRH225 17	BRHN120AF 19	CBM218CU 38
BR340 17	BRH225E 21	BRHN120GF 20	CBM230 37
BR340E 21	BRH230 17	BRHN125GF 20	CBM230CU 38
BR345 17	BRH230E 21	BRHN130GF 20	CBM242 37
BR345E 21	BRH235 17	BRL215CAF 19	CBRPL112 10
BR350 17	BRH235E 21	BRL220CAF 19	CBRPL112G3 46
BR350E 21	BRH240 17	BRLAFGFLOFF 24	CBRPL112G6 46
BR360 17	BRH240E 21	BRLW1-10 24	CBRPL116 10
BR360E 21	BRH245 17	BRLW2-10 24	CBRPL120 10
BR370 17	BRH245E 21	BRLW-10 24	CBRPL120G6 46
BR370E 21	BRH250 17	BRN115AFC 19	CBRPL130 10
BR380 17	BRH250E 21	BRN115DFC 19	CBRPL130G6 46
BR380E 21	BRH260 17	BRN115EP 20	CBRPL220 10
BR390 17	BRH260E 21	BRN115GFC 20	CBRPL240 10

Residential and light commercial products

CBRPM112 6	CH215EPD 34	CHF250 31	CHP280 32
CBRPM116 6	CH215GFT 34	CHFAGGF115 33	CHP290 32
CBRPM116Z 6	CH220CAF 33	CHFAGGF115PN 33	CHP310 32
CBRPM120 6	CH220EPD 34	CHFAGGF120 33	CHP315 32
CBRPM130 6	CH220GFT 34	CHFAGGF120PN 33	CHP320 32
CBRPM130Z 6	CH225GFT 34	CHFAGGFLOFF 36	CHP325 32
CBRPM140 6	CH230EPD 34	CHFCAF115 33	CHP330 32
CBRPM140Z 6	CH230GFT 34	CHFCAF115PN 33	CHP335 32
CBRPM216 6	CH235GFT 34	CHFCAF120 33	CHP340 32
CBRPM220 6	CH240EPD 34	CHFCAF120PN 33	CHP345 32
CBRPM230 6	CH240GFT 34	CHFEP115 34	CHP350 32
CBRPM236GEN 45, 46	CH245GFT 34	CHFEP120 34	CHP360 32
CBRPM240 6	CH250EPD 34	CHFEP125 34	CHP370 32
CBRPM260 6	CH250GFT 34	CHFEP130 34	CHP2100 32
CBRPM1520 6	CH250SUR 48	CHFGFT115 34	CHP2125 32
CBRPM1530 6	CH260 31	CHFGFT115PN 34	CHP3100 32
CBRPM1540 6	CH260EPD 34	CHFGFT120 34	CHPL 36
CBSF100 44	CH260GFT 34	CHFGFT120PN 34	CHPLGF 36
CBSF225 44	CH270 31	CHFGFT125 34	CHRLS 36
CC3100 23	CH280 31	CHFGFT130 34	CHSF2125 36
CC3125 23	CH290 31	CHFGFT130PN 34	CHSPALARM 47
CC3150 23	CH310 31	CHFP 36	CHSPCABLE 49
CC3200 23	CH315 31	CHHT 36	CHSPFMKIT 49
CCHPL124 30	CH320 31	CHLO 36	CHSPT2MICRO 49
CCHPL232 30	CH325 31	CHNS 36	CHSPT2ULTRA 49
CCHPM124 30	CH330 31	CHNT1515 31	CHSPT22PACK 49
CCHPM132 30	CH335 31	CHNT1520 31	CHT1515 31
CCHPM132Z 30	CH340 31	CHNT2020 31	CHT1520 31
CCHPM142 30	CH345 31	CHP110 32	CHT2020 31
CCHPM142Z 30	CH350 31	CHP115 32	CHWPS2040D 64
CCHPM242 30	CH360 31	CHP120 32	CHWPS2040DL 64
CCHPM260 30	CH370 31	CHP125 32	CHWPS2040DP 64
CCL300 24	CH380 31	CHP130 32	CHWPS3050D 64
CCPL 24	CH390 31	CHP135 32	CHWPS3050DL 64
CCPL102 10	CH3100 31	CHP140 32	CHWPS4060D 64
CCPL104 10	CHF115 31	CHP145 32	CPL072 14
CCPL108 10	CHF120 31	CHP150 32	CPL072FGP 14
CH6L125R 30	CHF125 31	CHP160 32	CPL072R 14
CH9FL 15	CHF130 31	CHP170 32	CPL072RGP 14
CH30SPAST 47	CHF135 31	CHP210 32	CPL072SGP 14
CH40SPAST 47	CHF140 31	CHP215 32	CPL400KIT 15
CH50SPAST 47	CHF145 31	CHP220 32	CPL442 10
CH60SPAST 47	CHF150 31	CHP225 32	CPM116COV 15
CH115AF 33	CHF215 31	CHP230 32	CPM120COV 15
CH115AFPN 33	CHF220 31	CHP235 32	CPM342 6
CH115EPD 34	CHF225 31	CHP240 32	CPM400KIT 15
CH115GF 34	CHF230 31	CHP245 32	CPM442 6
CH160 31	CHF235 31	CHP250 32	CPM1520 6
CH170 31	CHF240 31	CHP260 32	CPM1530 6
CH215CAF 33	CHF245 31	CHP270 32	CPM1540 6

Residential and light commercial products

CQLP8100 58, 59	GFTCB230 20	NHP20-1231 59	QB1030GF 43
CQLP12100 58, 59	GFTCB240 20	NL20 15	QBGFEF2015 43
CSABP4683B 58	GFTCB250 20	NL30 15	QBGFEF2020 43
CSABP4734B 58	GFTCB260 20	NL300 15	QBGFEF2025 43
CSR2100N 35	GFTCBH215 20	NSP42 15	QBGFEF2030 43
CSR2125N 23, 35	GFTCBH220 20	P48G11S03CUB 56	QBGFT1040 43
CSR2150N 23, 35	GFTCBH225 20	P48G11S03P 55	QBGFT2015 43
CSR2200N 23, 35	GFTCBH230 20	P48G11S05CUB 56	QBGFT2020 43
CVRSCRW 15	GFXB115B2 22	P48G11S05P 55	QBGFT2030 43
DIRCARD42 44	GFXB120B2 22	P48G11S07CUB 56	QBGFT2040 43
DIRSLEEVE 44	GFXB125B2 22	P48G11S07P 55	QBGFT2050 43
DNBA1515 42	GFXB130B2 22	P48G11S10CUB 56	QBH15 62
DNBA2020 42	HBQL15 60	P48G11S10P 55	QBH20 62
DNBA3030 42	HBQL20 60	P48G11S15CUB 56	QBH25 62
DNPL1515 18	HBQL25 60	P48G11S15P 55	QBH30 62
DNPL1515E 21	HBQL30 60	P48G11S25CUB 56	QBH40 62
DNPL1520 18	HBQL40 60	P48G11S25P 55	QBH50 62
DNPL1520E 21	HBQL50 60	P48G28T15CUB 56	QBH60 62
DNPL1530 18	HBQL60 60	P48G28T15P 55	QBH215 62
DNPL2020 18	HBQL315 60	P48G28T21CUB 56	QBH220 62
DNPL2020E 21	HBQL330 60	P48G28T21P 55	QBH225 62
DNPL151515 18	HBQL350 60	P48G28T30CUB 56	QBH230 62
DNPL152015 18	HBQL360 60	P48G28T30P 55	QBH240 62
DNPL152515 18	HBQL370 60	P60G11S03CUB 56	QBH250 62
DNPL153015 18	HBQL390 60	P60G11S05CUB 56	QBH260 62
DNPL154015 18	HBQL3100 60	P60G11S05P 55	QBH270 62
DNPL155015 18	HLW1-10 24	P60G11S07CUB 56	QBH290 62
DNPL215215 18	ISGRD 15, 44	P60G11S07P 55	QBH1015AFGF 42
DNPL215220 18	LCCS 36	P60G11S10CUB 56	QBH1015CAF 42
DNPL215230 18	MABL300 24	P60G11S10P 55	QBH1015EP 43
DNPL215240 18	MCBPL 24, 36	P60G11S15CUB 56	QBH1020AFGF 42
DNPL220220 18	NHP4-632 59	P60G11S15P 55	QBH1020CAF 42
DNPL220230 18	NHP6-30-60 59	P60G11S25CUB 56	QBH1020EP 43
DS075H1 15	NHP6-60 59	P60G11S25P 55	QBH1025EP 43
DS100H1 15	NHP6-633 59	P60G28T15CUB 56	QBH1030EP 43
DS125H1 15	NHP6-636-4 59	P60G28T15P 55	QBH2100 62
DS150H1 15	NHP8-60 59	P60G28T21CUB 56	QBH2125 62
DS200H1 15	NHP8-635-3 59	P60G28T21P 55	QBHGFEP2015 43
DS200H2 15, 52, 53	NHP10-0401-4 59	P60G28T30CUB 56	QBHGFEP2020 43
DS250H2 15, 52, 53	NHP10-0601-2 59	P60G28T30P 55	QBHGFEP2025 43
DS300H2 15, 52, 53	NHP10-0611 59	QB1015AFGF 42	QBHGFEP2030 43
GFEP215 20	NHP10-636-3 59	QB1015CAF 42	QBHW1015 41
GFEP220 20	NHP10-0801 59	QB1015EP 43	QBHW1020 41
GFEP225 20	NHP12-60 59	QB1015GF 43	QBHW1030 41
GFEP230 20	NHP12-633 59	QB1020AFGF 42	QBHW1040 41
GFEP240 20	NHP12-0811 59	QB1020CAF 42	QBHW1050 41
GFEP250 20	NHP12B-1000-2 59	QB1020EP 43	QBHW1060 41
GFTCB215 20	NHP14-0621-2 59	QB1020GF 43	QBHW1070 41
GFTCB220 20	NHP14-0801-4 59	QB1025EP 43	QBHW2015 41
GFTCB225 20	NHP20-0821-6 59	QB1030EP 43	QBHW2020 41

QBHW2030	41	RCPM108M	52
QBHW2040	41	RCPM112	7
QBHW2050	41	RCPM120	7
QBHW2060	41	RCPM130	7
QBHW2070	41	RCPM208M	52
QBHW2090	41	RCPM220	7
QBHW2100	41	RCPM230	7
QBHW2125	41	RCPM240	7
QBHW3015	41	RCPM1530	7
QBHW3020	41	RH75P	15
QBHW3030	41	RH100P	15
QBHW3040	41	RH125P	15
QBHW3050	41	SPC61	15
QBHW3060	41	SPCWH	15
QBHW3070	41	TDL	15, 36, 44
QBHW3090	41	THOW-10	24
QBHW3100	41	THS1	24
QL1NPL	44		
QL23NPL	44		
QL123PL	44		
QLPT14D	59		
QLPT16AD	59		
QLPT16D	59		
QLPT19D	59		
QLPT20AD	59		
QLPT20D	59		
QLPT22AD	59		
QLPT24D	59		
QLPT24LD	59		
R3CCPL103	13		
R3CPL112	13		
R3CPL130	13		
R3CPL136	13		
R3CPL230	13		
R3CPL242	13		
R3CPM112	9		
R3CPM130	9		
R3CPM230	9		
RCCHL102	30		
RCCPL102	11		
RCCPL104	11		
RCCPL108	11		
RCPL112	11		
RCPL120	11		
RCPL130	11		
RCPL220	11		
RCPL240	11		
RCPM1GF6H	53		
RCPM1GF10	53		
RCPM2GF6H	53		
RCPM2GF10	53		

Residential and light commercial products

Eaton
1000 Eaton Boulevard
Cleveland, OH 44122
United States
Eaton.com

Canadian Operations
5050 Mainway
Burlington, ON L7L 5Z1
Canada
EatonCanada.ca

© 2019 Eaton
All Rights Reserved
Printed in Canada
Publication No. CA003011EN
March 2019

Eaton is a registered trademark.

All other trademarks are property
of their respective owners.