

Version 2:

- Set the run-on time on the motion sensor to a value greater than 5 minutes
- Remain in the activation range of the motion sensor for a short time
 - > The motion sensor detects movement and switches on
 - > The corridorFUNCTION is activated automatically after 5 minutes
 - > The light value switches to presence value (default: 100%)
- Reset the run-on time of the motion sensor to the required value

Connecting Multiple Luminaires:

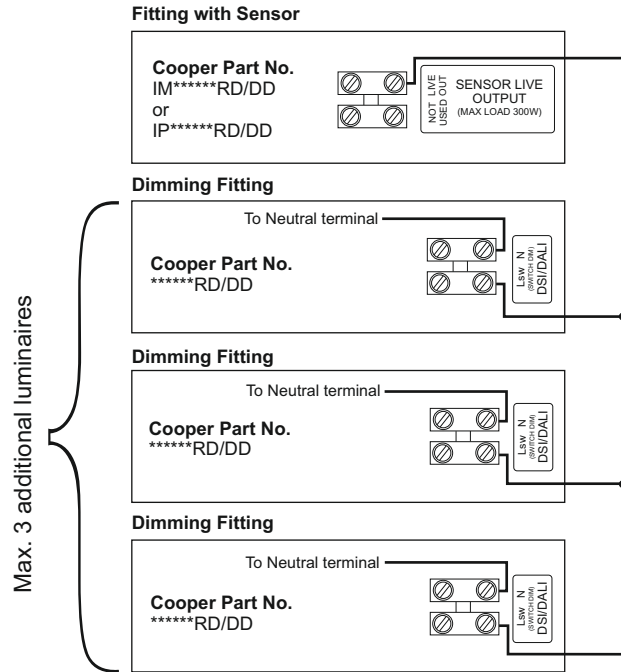

Deactivating the CorridorFUNCTION from the ***RD/DD luminaires:**

If the corridorFUNCTION is activated the ballast is controlled only by motion. To operate the *****RD/DD luminaires via DALI, DSI or switchDIM the corridorFUNCTION must be deactivated.

Procedure:

- Fitting must be powered
- Connect mains voltage switch to control input Lsw
- Connect neutral conductor to control input at input N
- Press the switch 5 times within 3 seconds



Installation Instructions for: Microwave Motion Sensor

Technical Specifications

PRODUCT TYPE: Microwave Motion Sensor
OPERATING VOLTAGE: 220/240V ~ 50Hz/60Hz
HF SYSTEM: 5.8GHz CW radar
TRANSMISSION POWER: <1mW
RATED LOAD: 800W (resistive load)
 400W (inductive load)

DETECTION ANGLE: 30~150°
POWER CONSUMPTION: Approx 0.9W
REACH: 1-5m (radi), adjustable
TIME SETTING: 5s~25min
MOUNTING: Indoors, ceiling & walling mounted
LIGHT CONTROL: 2~30 LUX
Working temperature: 0~50°C

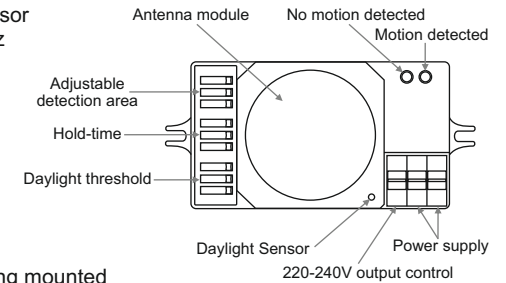

The sensor is an active motion detector; it emits a high-frequency electromagnetic wave 5.8GHz and receives its echo. The sensor detects the change in echo from movement in its detection zone. A microprocessor then triggers the switch light ON command. Detection is possible through doors, panels of glass or thin walls.

NOTE: the high-frequency output of this sensor is<1mW; approximately just 1% of the transmission power of a mobile telephone or the output of a microwave oven.

IMPORTANT
PLEASE READ THESE INSTRUCTIONS CAREFULLY PRIOR TO INSTALLATION AND RETAIN THIS LEAFLET IN A KNOWN AND SAFE PLACE FOR FUTURE REFERENCE

Section 1 Installation

ENSURE THAT THE ELECTRICITY SUPPLY IS SWITCHED OFF COMPLETELY BEFORE INSTALLING OR SERVICING THIS PRODUCT

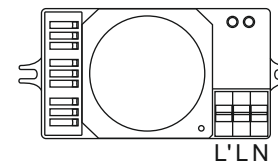

The sensor works with main voltage of 220-240V (+/- 10%) 50/60 Hz. A 100-120 V version is available on request.
 The sensor has a 3-wire electrical interface:
 N (neutral / 230 V AC)
 L (phase / 230 V AC)
 L' (switched phase / output)

This sensor is suitable for indoor use, and is also designed for installation at 3~5m in height. While sensor use with Hytronik sensorDIM ballast or other dimming ballast, please keep the sensor antenna module from the ballast and lamp filament by at least 80mm.

Section 2 Settings

Detection range:

This determines the effective range of the motion detector and is set by DIP switches at the sensor itself, refer to figure. Note that reducing the sensitivity will also narrow the detection range.

The following settings are available:

- I - maximum range up to 5m
- II - range up to 3.5m
- III - range up to 2m
- IV - range up to 1.5m
- V - range up to 1m

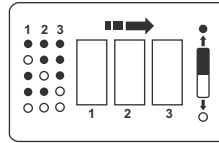

Hold time:

This determines the time the fitting remains at 100% level on motion detector and is set with DIP switches at the sensor itself, refer to figure. The walk test setting is useful when installing the fitting to establish correct operation and range.

The following settings are available:

- I - Walk test mode 5s
- II - 30s
- III - 3 minutes
- IV - 5 minutes
- V - 15 minutes
- VI - 25 minutes

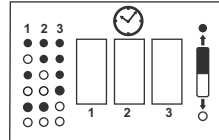

Daylight sensor:

This setting holds off the 100% light output should there be sufficient daylight and is set using DIP switches at the sensor itself, refer to figure.

The following settings are available:

- I - 2 lux darkness operation only
- II - 5 lux darkness operation only
- III - 20 lux twilight operation
- IV - 30 lux twilight operation
- V - *daylight, photocell disabled

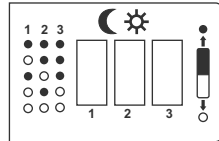

If the sensor is positioned next to a light source this must be disabled

*In daylight setting the lamp(s) will always be on with motion detected and operate at 100% light output, even in bright daylight

Section 3 Troubleshooting

MALFUNCTION CAUSE REMEDY	CAUSE	REMEDY
The load will not work	Incorrect light-control setting selected	Adjust setting
	Load faulty	Replace load
	Mains switch OFF	Switch ON
The load is always on	Continuous movement in detection zone	Check zone setting
The load is on without any identifiable movement	The sensor is not mounted for reliably detecting movement	Securely mount enclosure
	Movement occurred, but not identified by the sensor (movement behind wall, movement of small object in immediate lamp vicinity etc.)	Check zone setting
The load will not work despite movement	Rapid movements are being suppressed to minimise malfunctioning or the detection radius is too small	Check zone setting

Installation Instructions for:

CorridorFUNCTION

This section only relevant to products with the CorridorFUNCTION installed.

Important!

To optimise lamp life and performance, a minimum burn-in period of 100 hours at full output is recommended before dimming the lamp

This instruction leaflet gives details of how to wire and commission a luminaire or series of luminaires for CorridorFUNCTION. CorridorFUNCTION is a feature of the ballast and not the occupancy detector. It allows the detector to switch the ballast such that it will dim to 10% rather than switching off when occupancy is no longer detected.

Cooper IM/IP*****RD/DD luminaires enable CorridorFUNCTION to be used. One 'master' luminaire with the IM/IP detector can be used to control up to 3 additional Cooper *****RD/DD luminaires. Take care to ensure the occupancy detection coverage is suitable when controlling multiple luminaires from one detector.

CorridorFUNCTION Details:

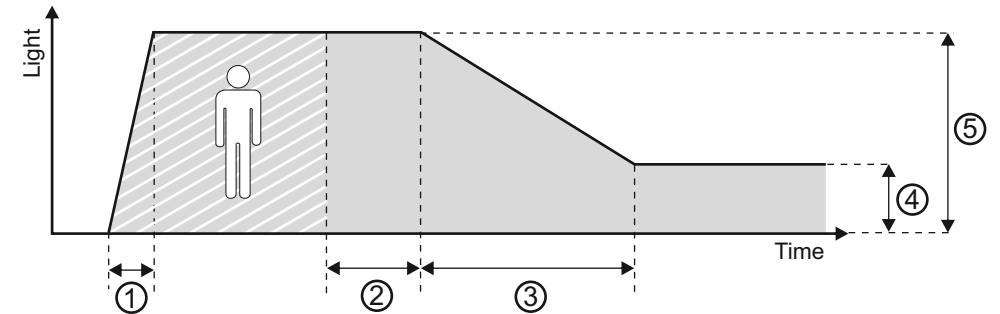

1. Fade-in time: the time that starts as soon as the presence of a person is detected.
2. Run-on time (Dependent on sensor): the time that starts as soon as the presence of a person is no longer detected.
3. Fade time (32s): the time during which the luminous intensity is faded from the presence value to the absence value.
4. Absence value (10%): the luminous intensity when there is no person present
5. Presence value (100%): the luminous intensity when persons are present

Activating the CorridorFUNCTION:

Activating the corridorFUNCTION is simple. If an ac voltage of 230 V is applied to the digital interface of the ballast for a period of at least 5 minutes the ballast detects the corridorFUNCTION and automatically activates it. Activation is required only once per device.

There are two procedures for activating by means of the mains voltage.

Procedure:

Version 1:

- Remain in the activation range of the motion sensor for more than 5 minutes
 - > The motion sensor detects movement and switches on
 - > The corridorFUNCTION is activated automatically after 5 minutes
 - > The light value switches to presence level (default: 100%)