

CEAG Products
Explosion protected luminaires

CROUSE-HINDS
SERIES



RLF LED A 600 (N) / 1200 (N)

Explosion-protected LED-recessed ceiling luminaire for Zone 1, 2, 21 and 22



EATON

Powering Business Worldwide

Explosion-protected recessed ceiling LED-light fittings in compact metal design

RLF LED A 600, RLF LED A 1200 and self-contained emergency luminaire RLF LED A 600 N, RLF LED A 1200 N (Zone 1, 2, 21, 22)

The explosion-protected lighting concept for recessed ceiling light fittings.

The new Ex recessed-ceiling light fittings RLF ..LED A are especially used for spraying cabinets and paint shops for installation in ceilings where smooth and flush surfaces are important. The glass pane, which is installed with a metal hinge, allows the use of cleaning solvents, if necessary, in order to remove easily spray mist and paintbrushes. Similar requirements are also encountered in the pharmaceutical and chemical industries as well as in technology labs, where simple cleaning and smooth design are essential.

Designed for easy installation

The housing comprises white-painted steel sheet with an optional cover frame for ceiling mounting. In addition, it can also be fixed by means of two M8 drilled holes on the top of the housing. For an external PE-connection two screw terminals up to 6 mm² are available.



The hinged, frameless pane made of 5 mm thick safety glass is fixed with 2 resp. 3 captive screws and has inside hinges. The EPDM sealing ensures the high degree of protection IP65.

Long-term safety

Thanks to its large input voltage range the electronic driver (110- 254 A AC / 220- 250 V DC) can be used internationally. Due to the low self-heating, ambient temperatures up to +60 °C are possible.

Versatile light

Depending on the application, three luminous flux versions are available in efficient LED technology (2500/5000/10000 lm) in various sizes. Through their variety even demanding lighting tasks can be faced. In addition, the light colour 6000K ensures an illumination similar to daylight, which is a high priority, for example, in paint shops.

Easy to install

The double-sided through-wiring in combination with the generous connecting space provides a cost-saving installation.



Using optional mounting brackets the luminaires can be installed adjustable on walls or ceilings

If you need a reliable and decentralised emergency lighting

The self-contained emergency light fitting RLF LED A... N ensures decentralised emergency lighting, independent of central systems. These luminaires offers in particular significant cost advantages, particularly in large-scale installations.

















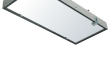



The self-contained emergency light fitting with integrated battery allows an autonomous emergency lighting with 1.5 h or 3 h rated operating time.



Features

- Universal electronic driver for 110 - 254 V AC / 220 - 250 V DC
- Various lumen packages up to 13447 lm in different sizes available
- Suitable for high ambient temperatures up to +60 °C
- Flush installation, especially for spraying cabinets and paint shops with optional mounting bracket
- Toughened safety glass
- With self-contained battery unit (RLF 250 LED...N)
- Suitable for B15 fire resistance ceilings

Ordering details

Type	Content	Luminous flux	Emergency lighting duration	Cable gland/ thread	Screw plugs	Order No.
RLF LED A 600						
	RLF LED A 600 3L	2/5-2K	3373 lm	1 x M25, Plastic cable gland	1 x M25	1 2286 111 103
	RLF LED A 600 3L	2/5-2M ¹⁾	3373 lm	2 x M20, Metal thread	1 x M20	1 2286 111 111
	RLF LED A 600 7L	2/5-2K	6664 lm	1 x M25, Plastic cable gland	1 x M25	1 2286 141 103
	RLF LED A 600 7L	2/5-2M ¹⁾	6664 lm	2 x M20, Metal thread	1 x M20	1 2286 141 111
RLF LED A 1200						
	RLF LED A 1200 7L	2/5-2K	6742 lm	1 x M25, Plastic cable gland	1 x M25	1 2286 241 103
	RLF LED A 1200 7L	2/5-2M ¹⁾	6742 lm	2 x M20, Metal thread	1 x M20	1 2286 241 111
	RLF LED A 1200 13L	2/5-2K	13447 lm	1 x M20, Plastic cable gland	1 x M25	1 2286 271 103
	RLF LED A 1200 13L	2/5-2M ¹⁾	13447 lm	2 x M20, Metal thread	1 x M20	1 2286 271 111
RLF LED A 600 N (self-contained emergency light fitting)						
	RLF LED A 600 N 3L	2/4-2K	3373 lm	1.5 h	1 x M25, plastic cable gland	1 x M25 1 2288 111 103
	RLF LED A 600 N 3L	2/5-2M ¹⁾	3373 lm	1.5 h	2 x M20, Metal thread	1 x M20 1 2288 111 111
	RLF LED A 600 N 3L	2/5-2K	3373 lm	3 h	1 x M25, Plastic cable gland	1 x M25 1 2289 111 103
	RLF LED A 600 N 3L	2/5-2M ¹⁾	3373 lm	3 h	2 x M20, Metal thread	1 x M20 1 2289 111 111
	RLF LED A 600 N 7L	2/5-2K	6664 lm	1.5 h	1 x M25, Plastic cable gland	1 x M25 1 2288 141 103
	RLF LED A 600 N 7L	2/5-2M ¹⁾	6664 lm	1.5 h	2 x M20, Metal thread	1 x M20 1 2288 141 111
	RLF LED A 600 N 7L	2/5-2K	6664 lm	3 h	1 x M25, Plastic cable gland	1 x M25 1 2289 141 103
	RLF LED A 600 N 7L	2/5-2M ¹⁾	6664 lm	3 h	2 x M20, Metal thread	1 x M20 1 2289 141 111
RLF LED A 1200 N (self-contained emergency light fitting)						
	RLF LED A 1200 N 7L	2/5-2K	6742 lm	1.5 h	1 x M25, Plastic cable gland	1 x M25 1 2288 241 103
	RLF LED A 1200 N 7L	2/5-2M ¹⁾	6742 lm	1.5 h	2 x M20, Metal thread	1 x M20 1 2288 241 111
	RLF LED A 1200 N 7L	2/5-2K	6742 lm	3 h	1 x M25, Plastic cable gland	1 x M25 1 2289 241 103
	RLF LED A 1200 N 7L	2/5-2M ¹⁾	6742 lm	3 h	2 x M20, Metal thread	1 x M20 1 2289 241 111
	RLF LED A 1200 N 10L	2/5-2K	13447 lm	1.5 h	1 x M25, Plastic cable gland	1 x M25 1 2288 271 103
	RLF LED A 1200 N 13L	2/5-2M ¹⁾	13447 lm	1.5 h	2 x M20, Metal thread	1 x M20 1 2288 271 111
	RLF LED A 1200 N 13L	2/5-2K	13447 lm	3 h	1 x M25, Plastic cable gland	1 x M25 1 2289 271 103
	RLF LED A 1200 N 13L	2/5-2M ¹⁾	13447 lm	3 h	2 x M20, Metal thread	1 x M20 1 2289 271 111

Scope of delivery with LED and without fixing accessories
Metal cable glands see catalogue part 2: 2.3.12 ff

Accessories / Polar curve / Dimension drawing

RLF LED A (N)

Accessories



Type	Application	Order No.
Mounting frame for ceiling mounting	for RLF LED A 600 / 600 N 3L	3 2283 000 001
Mounting frame for ceiling mounting	for RLF LED A 600 / 600 N 7L	3 2283 000 002
Mounting frame for ceiling mounting	for RLF LED A 1200 / 1200 N 3L	3 2283 000 003
Mounting frame for ceiling mounting	for RLF LED A 1200 / 1200 N 13L	3 2283 000 004
Set of wall bracket adjustable (2 pcs.)	for RLF LED A....	3 2283 000 007

Polar curve RLF... LED A

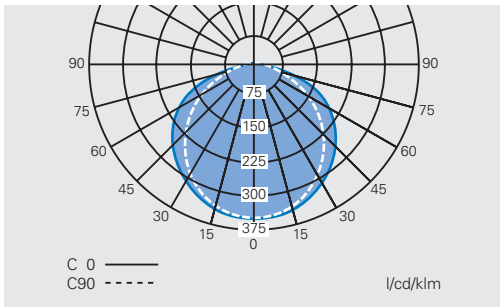

RLF LED A 600 / 1200..(N)

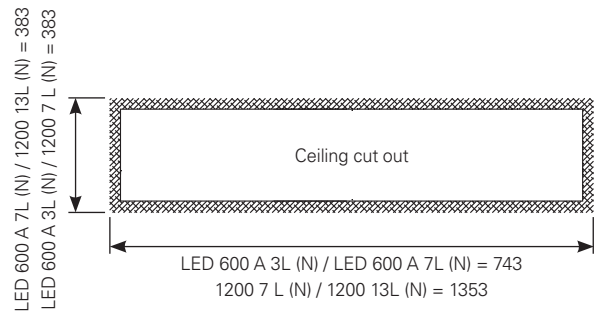
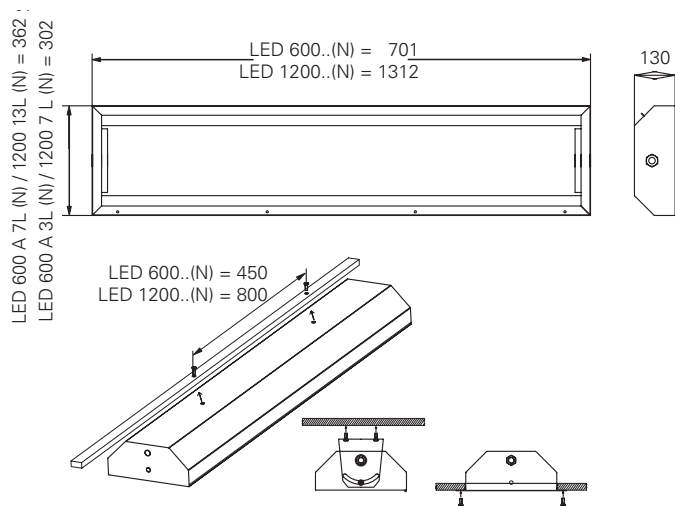

Mounting frame RLF LED A 600 / 1200..(N)

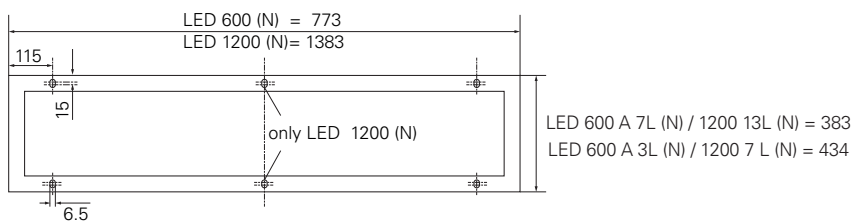

Dimensions in mm

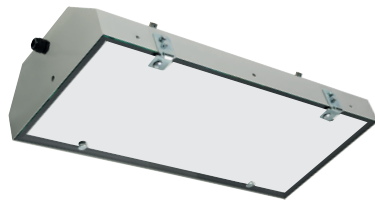

Technical data

	RLF LED A 600 3L / 7L	RLF LED A 1200 7L / 13L
EU-Type Examination Certificate	FTZÚ 17 ATEX 0002X	FTZÚ 17 ATEX 0002X
Marking accd. to 2014/34/EU	Ⓔ II 2 G Ex eb mb op is IIC T4 Gb Ⓔ II 2 D Ex tb IIIC T67°C Db	Ⓔ II 2 G Ex eb mb op is IIC T4 Gb Ⓔ II 2 D Ex tb IIIC T67°C Db
Permissible ambient temperature	-20 °C up to +60 °C	-20 °C up to +55 °C
Rated voltage	110- 254 V AC / 220- 250 V DC	110- 254 V AC / 220- 250 V DC
Rated current	0.13 A / 0.26 A at 230 V	0.24 A / 0.48 A at 230 V
Frequency	50- 60 Hz	50- 60 Hz
Power factor cos φ	≥ 0.95	≥ 0.95
Circuit	electronic LED-driver	electronic LED-driver
Protection class	I	I
Lamp / Illuminant	LED module 1 x 25 W / 2 x 25 W	LED module 1 x 50 W / 2 x 50 W
Rated luminous flux of the luminaire	3373 lm (3L) / 6664 lm (7L)	6742 lm (7L) / 13447 lm (13L)
Light colour/ CRI	6000 K / R _a >70 ²⁾	6000 K / R _a >70 ²⁾
Dimensions (L x W x H)	701 x 302 x 130 mm / 701 x 362 x 130 mm	1312 x 302 x 130 mm / 1312 x 362 x 130 mm
Connecting terminals	L1, L2, L3, N, PE; max. 2 x 2.5 mm ² twin-ended through-wiring	L1, L2, L3, N, PE; max. 2 x 2.5 mm ² twin-ended through-wiring
Enclosure colour	white RAL 9010	white RAL 9010
Enclosure material	painted steel sheet ³⁾	painted steel sheet ³⁾
Weight	9.5 kg (3L) / 11.9 kg (7L)	15.6 kg (7L)/ 18.4 kg (13L)
Cable glands / gland plates / enclosure drilling	Ex-e cable glands M25 x 1.5 (plastic), option: M20 x 1.5 metal thread ¹⁾	Ex-e cable glands M25 x 1.5 (plastic), option: M20 x 1.5 metal thread ¹⁾
Degree of protection accd. to EN 60529	IP65	IP65
Protective cover / protective bowl	single-safety glass pane of 5 mm thick	single-safety glass pane of 5 mm thick

1) with dustcover if entry/thread is not closed

2) 4000 K on request

3) polished stainless steel 304 (1.4301 (Inox) on request

Technical Data

RLF LED 600 N / RLF LED 1200 N

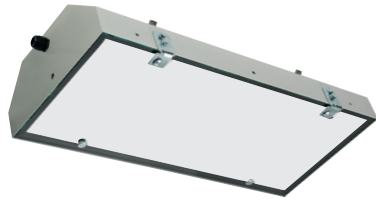

Technical data

	RLF LED 600 N 3L / 7L	RLF LED 1200 N 7L / 13L
EU-Type Examination Certificate	FTZÚ 17 ATEX 0002X	FTZÚ 17 ATEX 0002X
Marking accd. to 2014/34/EU	⊕ II 2 G Ex eb mb op is IICT4 Gb ⊕ II 2 D Ex tb IICT67°C Db	⊕ II 2 G Ex eb mb op is IICT4 Gb ⊕ II 2 D Ex tb IICT67°C Db
Permissible ambient temperature	0 °C up to +40 °C	0 °C up to +35 °C
Rated voltage	110- 254 V AC / 220- 250 V DC	110- 254 V AC / 220- 250 V DC
Rated current	0.14 A / 0.26 A at 230 V	0.25 A / 0.49 A at 230 V
Frequency	50- 60 Hz	50- 60 Hz
Power factor cos φ	≥ 0.95	≥ 0.95
Circuit	electronic LED-driver	electronic LED-driver
Protection class	I	I
Lamp / Illuminant	LED module 1 x 30 W / 2 x 30 W	LED module 1 x 50 W / 2 x 50 W
Rated luminous flux of the luminaire	3373 lm (3L) / 6664 lm (7L)	6742 lm (7L) / 13447 lm (13L)
Light colour/ CRI	6000 K / R _a >70 ²⁾	6000 K / R _a >70 ²⁾
luminous flux in emergency mode 1.5 h, one LED module 3 h, one LED module	RLF LED A 600 N 1.5h 3L – 515lm RLF LED A 600 N 3.0h 3L – 383lm RLF LED A 600 N 1.5h 7L- 746lm RLF LED A 600 N 3.0h 7L- 406lm	RLF LED A 1200 N 1.5h 7L – 829lm RLF LED A 1200 N 3.0h 7L- 447lm RLF LED A 1200 N 1.5h 13L – 829lm RLF LED A 1200 N 3.0h 13L – 455lm
Emergency lighting duration	1.5 h or 3 h	1.5 h or 3 h
Dimensions (L xW x H)	701 x 302 x 130 mm / 701 x 362 x 130 mm	1312 x 302 x 130 mm / 1312 x 362 x 130 mm
Connecting terminals	L, L1,L2, L3, N, PE; max. 2 x 2.5 mm ² twin-ended through-wiring	L, L1,L2, L3, N, PE; max. 2 x 2.5 mm ² twin-ended through-wiring
Enclosure colour	white RAL 9010	white RAL 9010
Enclosure material	painted steel sheet ³⁾	painted steel sheet ³⁾
Weight	11.50 kg 3L (1.5h)/ 12.10 kg 7L (3h) 13.60 kg 7L (1.5h)/ 14.80 kg 13L (3h)	16.40 kg 7L (1.5h)/ 18.40 kg 7L (3h) 18.50 kg 13L (1.5h)/ 19.10 kg 13L (3h)
Cable glands / gland plates / enclosure drilling	Ex-e cable glands M25 x 1.5 (plastic) , option: M20 x 1.5 metal thread ¹⁾	Ex-e cable glands M25 x 1.5 (plastic) , option: M20 x 1.5 metal thread ¹⁾
Degree of protection accd. to EN 60529	IP65	IP65
Protective cover / protective bowl	single-safety glass pane of 5 mm thick	single-safety glass pane of 5 mm thick

1) with dustcover if entry/thread is not closed

2) 4000 K on request

3) polished stainless steel 304 (1.4301 (Inox) on request

Eaton's Crouse-Hinds Business

The safety you rely on.

See the complete offering of Hazardous and Industrial Products at www.crouse-hinds.de.

U.S. (Global Headquarters): Eaton's Crouse-Hinds Business

1201 Wolf Street
Syracuse, NY 13208

(866) 764-5454
FAX: (315) 477-5179
FAX Orders Only:
(866) 653-0640

CrouseCustomerCTR@Eaton.com

For more information:

If further assistance is required, please contact an authorized Eaton Distributor, Sales Office, or Customer Service Department.

Australia

Phone +61-2-8787-2777
Fax +61-2-9609-2342
crousehindsanz@eaton.com

China

Phone +86-21-2899-3600
Fax +86-21-2899-4055
ECHsales@eaton.com

Great Britain

Phone +44-247-630-89 30
Fax +44-247-630-10 27
sales5@eaton.com

India

Phone +91-124-4683888
Fax +91-124-4683899
cchindia@eaton.com

Canada

Toll Free +1-800-265-0502
Fax +1-800-263-9504
Fax orders only:
+1-866-653-0645

Korea

Phone +82-2-3484-6783
Fax +82-2-3484-6778
CCHK-sales@
cooperindustries.com

Mexico/Latin America/ Caribbean

Phone +52-555-804-4000
Fax +52-555-804-4020
mxmercadotecnica@cooperindustries.com

Spain

Phone +34-9-37362710
Fax +34-9-37835055
sales.CCH.es@cooperindustries.com

Middle East (Dubai)

Phone +971-4-427-2522 / 2500
Fax +971-4-429-8521
CHMEsales@Eaton.com

The Netherlands

Phone +31-10-2452145
Fax +31-10-2452121
CHRD_mail@Eaton.com

Norway

Phone +47-32-244600
Fax +47-32-244646
CHLloffice@eaton.com

Singapore:

Phone +65-6645-9888
Fax +65-6297-4819
CHSI-Sales@Eaton.com

Turkey

Phone +90-216-464-20-20
Fax +90-216-464-20-10
infoEGTurkey@eaton.com

Russia

Phone +7-495 510-24-27
Fax +7-495 510-24-28
info@cooper.ru.com
www.cooper-russia.ru

Eaton

Neuer Weg – Nord 49
D-69412 Eberbach

Phone +49 (0) 6271/806-500
Fax +49 (0) 6271/806-476
E-mail info-ex@eaton.com
Internet www.crouse-hinds.de

Eaton

1000 Eaton Boulevard
Cleveland, OH 44122
United States
Eaton.com

© 2017 Eaton Corporation
All Rights Reserved
Printed in Germany
Publication No. BR 300 8000 2286
August 2023

Changes to the products, to the information contained in this document, and to prices are reserved; so are errors and omissions. Only order confirmations and technical documentation by Eaton is binding. Photos and pictures also do not warrant a specific layout or functionality. Their use in whatever form is subject to prior approval by Eaton. The same applies to Trademarks (especially Eaton, Moeller, and Cutler-Hammer). The Terms and Conditions of Eaton apply, as referenced on Eaton Internet pages and Eaton order confirmations.

Eaton's Crouse-Hinds Business

1201 Wolf Street
Syracuse, NY 13208
(866) 764-5454
CrouseCustomerCTR@Eaton.com

Eaton is a registered trademark.

All other trademarks are property of their respective owners.



Powering Business Worldwide