

LED lighting
Champ-Pak® WPMV LED wall pack

CROUSE-HINDS
SERIES

Champ-Pak WPMV

LED wall pack for heavy industrial



Safe. Reliable. Efficient.
3,000, 5,000 & 7,000 lumen models

EATON

Powering Business Worldwide



Champ-Pak WPMV wall packs

Safe. Reliable. Efficient.

Featuring a broad range of LED luminaires for harsh industrial environments, Eaton's Crouse-Hinds delivers lighting solutions that perform reliably in even the worst operating conditions. This reduces energy, maintenance, and manpower costs.

Why LED?

Energy efficiency

LED average energy consumption is significantly less than traditional fluorescent and HID fixtures

Start/restart time

Instant illumination vs. 10 minute restrike time for HID

Light quality

Higher color rendering compared to fluorescent and HID

Environmental benefits

Mercury-free LED eliminates disposal costs and lower energy consumption for a smaller carbon footprint

Why Crouse-Hinds?

Industry-best reliability

Built to withstand a wide array of applications

Thermal management

Effective heat sinking ensures longer life

Quality of light

Custom optics designed to maximize light distribution and intensity

Globally certified

Designed to global specifications for IEC and NEC applications

Serviceable drivers

Easy access to drivers for service or replacement

Design features

Built to last:

- Type 4X rated
- Impact-resistant lens sealed from the outside environment provides ingress protection against water and dust
- 60,000+ hours of operation at 55°C
- 5 year fixture warranty†

† Refer to the authorized distributor price book for Crouse-Hinds standard Terms and Conditions.



High efficiency:

- Up to 116 lumens per watt

Multiple lens options:

- Clear glass lens standard
- Optional lenses include:
 - Diffused glass
 - Clear polycarbonate
 - Diffused polycarbonate

Simple installation and replacement:

- Contractor-friendly design is ideal for both retrofit and new construction
- Available with lever lock connectors



Rugged design

- Engineered to perform in ambient temperatures from -40°C to +55°C
- Die cast aluminum LED housing provides efficient thermal path to heat sink assembly
- Vertical fin design facilitates air flow and dust shedding



Why choose Champ-Pak LED wall packs?

Reliable floodlights. WPMV LED wall packs are engineered to deliver high lumen output and maintenance-free long life in the toughest conditions.

WPMV7L vs. 150 watt HID



70%
ENERGY
EFFICIENCY



65%
TOTAL COST
OF OWNERSHIP



100%
MAINTENANCE
REDUCTION

Assumptions: Calculations based on overall life of the LED system. Energy cost of \$.09 per kilowatt; 24 hour per day operation; labor rate of \$75 each for 2 workers; average time for fixture maintenance of 1 hour.

Champ-Pak WPMV LED wall pack



Rugged wall pack solutions.

Eaton's Crouse-Hinds Champ-Pak WPMV LED wall packs are engineered to provide maintenance-free illumination, long life and high performance in extreme conditions.

The Champ WPMV LED is available from 3,000 to 7,000 lumens and is designed for harsh and heavy industrial applications.

Available models:

Model number	Nominal lumens*	Watts	Efficacy	Equivalent MH luminaire
WPMV3L	3,400	30.6	111 Lm/W	70W
WPMV5L	5,200	44.8	116 Lm/W	100W
WPMV7L	6,800	58.9	115 Lm/W	150W-175W

*Nominal lumens based on 5000K CCT with clear glass lens. Wattage measured at 120 VAC.

Primary applications:

- Indoor and outdoor wall mounting or vertical surfaces where minimal depth is required.
- Heavy industrial, mine site processing areas, platforms, loading docks, tunnels, outdoor wall and areas requiring frequent on-and-off of lights
- Locations requiring continuous and consistent light levels in extreme ambient temperatures
- Where extremely corrosive, wet, dusty, hot and/or cold conditions exist
- Type 4X, marine, wet locations and hose-down environments

Certifications & compliances:

- DesignLights Consortium® Qualified (*pending*)
- NEC and CEC
 - UL Standards: UL1598, UL1598A, UL8750
 - CSA Standard: C22.2 No. 250
- Marine and Wet Locations, NEMA 4X and IP66



Electrical ratings:

Model number	120V		277V		347V		480V	
	Input power	Input amps	Input power	Input amps	Input power	Input amps	Input power	Input amps
WPMV3L	30.6	0.26	30.6	0.11	29.9	0.09	30.3	0.07
WPMV5L	44.8	0.37	43.9	0.16	43.3	0.13	43.7	0.09
WPMV7L	58.9	0.50	57.8	0.23	56.0	0.16	56.2	0.12

All models

Voltage range, VAC	120-277V at 50/60 Hz, 347-480V at 60 Hz
Voltage range, VDC	125, 250VDC
Power factor	≥0.90
Surge	6kV standard
THD	≤ 20%



Champ-Pak WPMV wall packs are designed, tested and certified for extreme environments

Ordering information

Part number example

WPMV3LW-UNV1-S891

Champ-Pack Pro WPMV LED wall pack, NEC/CEC rated, 3,400 lumens, 3000K warm white, wall mount, 120-277 VAC, diffused glass window

WPMV 3L

Light source/intensity

3L	3,400 nominal lumens
5L	5,200 nominal lumens
7L	6,800 nominal lumens

W

Color temperature

BLANK	Cool (5000K)
N*	Neutral (4000K)
W	Warm (3000K)

*Consult factory for availability.

- UNV1

Voltage

-UNV1	120-277 VAC, 50/60 Hz; 125, 250VDC
-UNV34	347-480 VAC, 50/60 Hz

- S891

Window material

BLANK	Clear glass
S891	Diffused glass
S903	Clear polycarbonate
S903D	Diffused polycarbonate

Dimensions

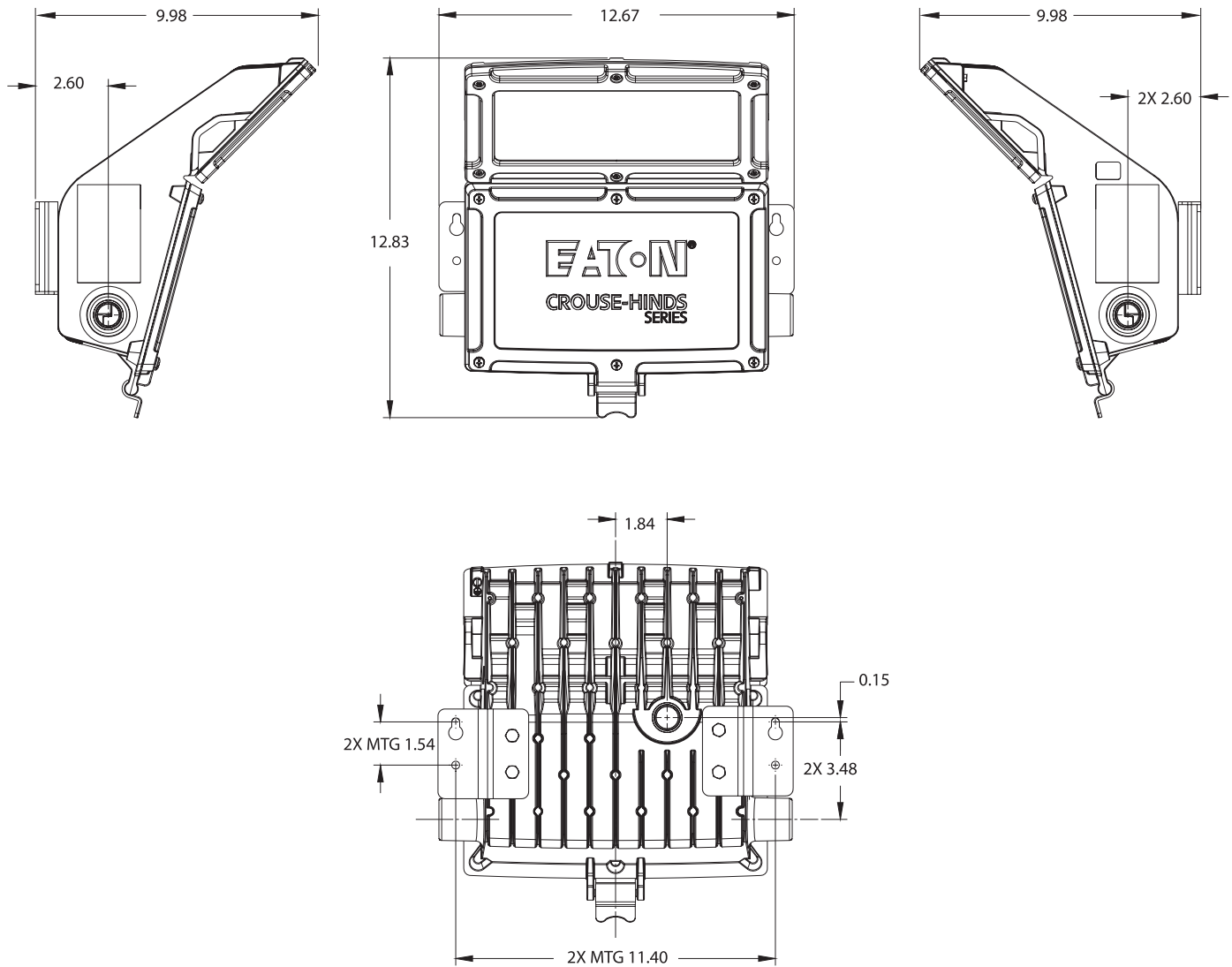

Photometrics

WPMV3L-UNV1

Illuminance (Fc)	
Average	0.3
Min.	0.0
Max.	1.6

CPMVM 070

Illuminance (Fc)	
Average	0.3
Min.	0.0
Max.	1.3

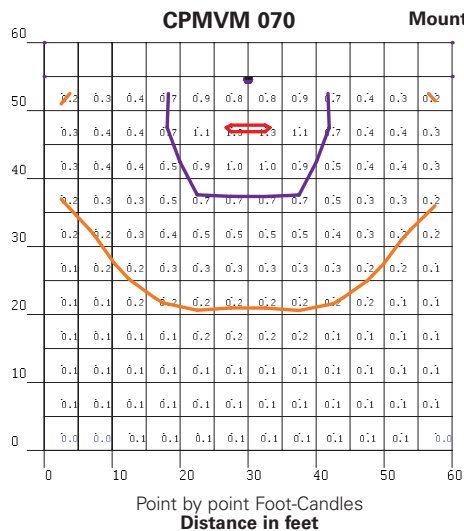

WPMV3L-UNV1

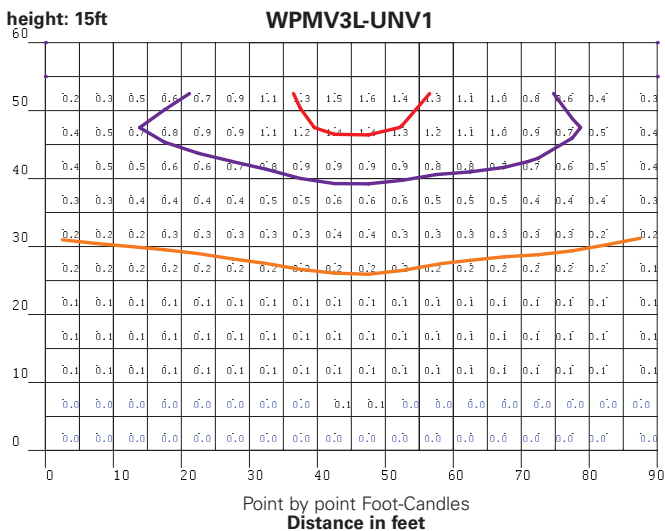

WPMV5L-UNV1

Illuminance (Fc)	
Average	0.5
Min.	0.0
Max.	2.4

CPMVM 100

Illuminance (Fc)	
Average	0.5
Min.	0.1
Max.	2.3

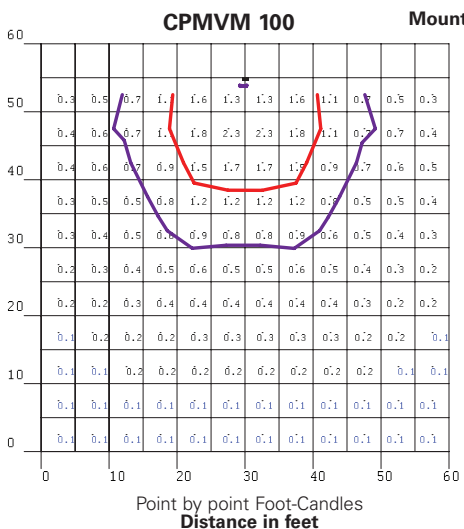

WPMV5L-UNV1

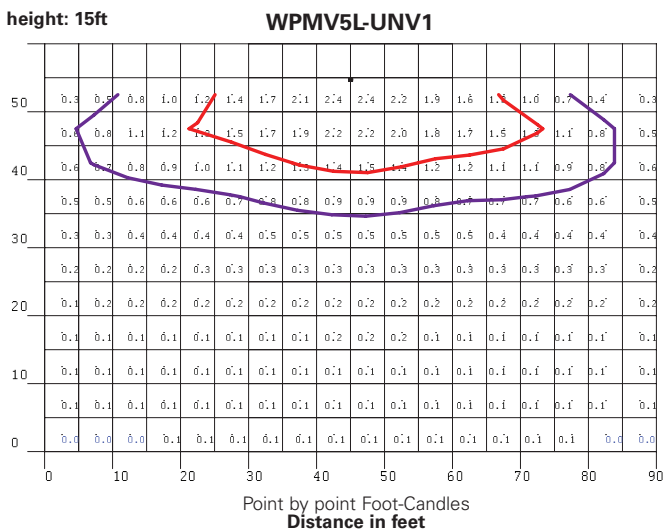

WPMV7L-UNV1

Illuminance (Fc)	
Average	0.7
Min.	0.1
Max.	3.2

CPMVM 150

Illuminance (Fc)	
Average	0.8
Min.	0.1
Max.	1.5

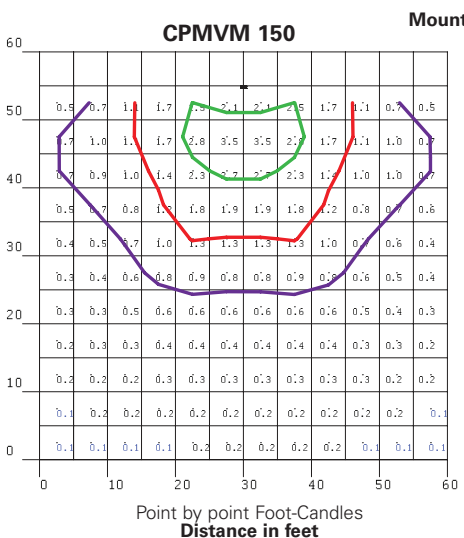

WPMV7L-UNV1

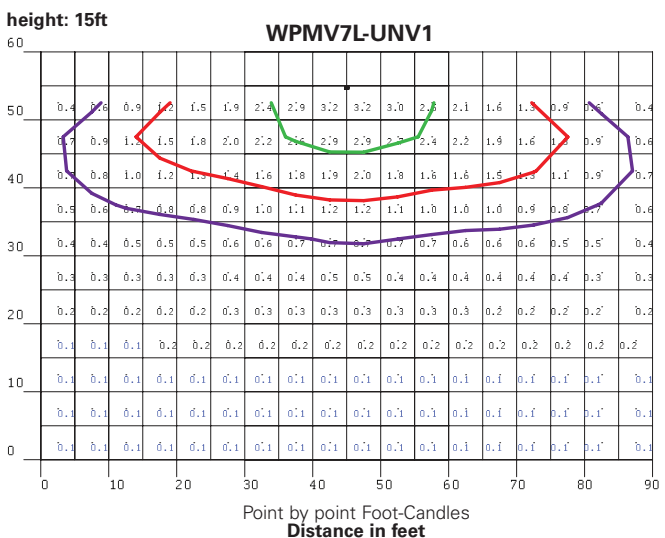

**U.S. (global headquarters):
Eaton's Crouse-Hinds Division**

1201 Wolf Street
Syracuse, NY 13208

(866) 764-5454
FAX: (315) 477-5179
FAX Orders Only:
(866) 653-0640

crousecustomerctr@eaton.com

For more information:

If further assistance is required, please contact an authorized Eaton Distributor, Sales Office, or Customer Service Department.

Canada

Toll Free: 800-265-0502
FAX: (800) 263-9504
FAX Orders only: (866) 653-0645

Mexico/Latin America/Caribbean

52-555-804-4000
FAX: 52-555-804-4020
ventascentromex@eaton.com

Europe (Germany)

49 (0) 6271 806-500
49 (0) 6271 806-476
info-ex@eaton.com

Middle East

971 4 8066100
FAX: 971 4 8894813
chmesales@eaton.com

Singapore

65-6645-9888
FAX: 65-6297-4819
chsi-sales@eaton.com

China

86-21-2899-3600
FAX: 86-21-2899-4055
echsales@eaton.com

Korea

82 2 6380 4032
82-2-6380-4070
ECHKsales@eaton.com

Australia

1300-332-866
FAX: 61-2-9693-5127
crousehindsanz@eaton.com

India

91-124-4683888
FAX: 91-124-4683899
cchindia@eaton.com

Eaton
1000 Eaton Boulevard
Cleveland, OH 44122
United States
Eaton.com

© 2019 Eaton
All Rights Reserved
Printed in USA
Publication No. 5430-0120
January 2020

Eaton is a registered trademark.

All other trademarks are property of their respective owners.