

EMAR ECOS SERIES

LINEAR FLUORESCENT LUMINAIRES

Installation & Maintenance Information

COOPER Crouse-Hinds
PAULUHN
IF LBL1579

SAVE THESE INSTRUCTIONS FOR FUTURE REFERENCE

CAUTION Read carefully before installing and wiring the luminaire. These instructions include information for installation in Marine locations. Any warning or special instructions should be closely followed. Must be installed in accordance with the NEC (National Electrical Code) or CEC (Canadian Electrical Code) and all other applicable codes. All luminaires must be properly grounded.

Disconnect the fixture from the supply circuit before opening. Keep tightly closed when in operation. Do not attempt to install this luminaire unless you are familiar with warnings, cautions and procedures outlined in this information sheet. These luminaires are provided with one 3/4" plastic gland, one end plugged. NOTE: Do not use luminaire as a connection box or thru wiring for a circuit other than branch circuit supplying the luminaire.

INSTALLATION & ELECTRICAL WIRING

WARNING Risk of electrical shock hazard, only qualified personnel should conduct this procedure! Do not make electrical connections with the power ON. Disconnect supply circuit before opening fixture for servicing and/or re-lamping. Refer to fixture nameplate for minimum supply wire rating. See Emergency Battery Backup Ballast Instructions for fixture with EM option.

- Assemble Mounting Bracket (1A, 2x) to Housing using M8x15mm hexagon Bolts (1B, 2x) provided.
- Mount the fixture by the mounting brackets (1A, 2x). Select proper anchor and surface to support fixture. See mounting dimensions illustration below.
- Release each lens latches (2A, 5x or 3x) and open lens (2B). Avoid damaging the sealing gasket during installation and/or servicing.
- Push retaining clips (3A, 2 sides) to open reflector (3A).
- If additional entries are needed, install listed or recognized water tight cord grips(s) thru the 3/4" NPT slip hole (4A). Proper cord grip(s) should be used and installed per manufacturers instructions to maintain a water tight seal.
- Route supply cable thru fitting.
- Strip the supply cable(s) jacket (not provided) back.
- Strip the insulation of the supply wires.
- WARNING** See nameplate for voltage & frequency requirements! See separate instruction sheets for fixture with optional emergency battery backup ballast. Fixtures may be provided with multi-voltage ballast, 120-277VAC 50/ 60Hz.
- Connect L1 or hot lead to terminal block L1 (5A) or black wire. Connect L2 or neutral to terminal block N (5A) or the common white wire. Connect ground wire to terminal block (5A) or green ground wire.
- Pull excess supply wire out of housing and tighten fitting to supply cable.
- Close reflector assembly (3A) and verify that each retaining clips (3A, 2side) are engage.
- WARNING** Verify that the fluorescent lamp complies with lamp specifications on fixture nameplate.
- Install the proper type & wattage lamps (not provided) into the lamp holder (6A) and rotate 90 degrees to lock into place, or simply depress spring loaded lamp holder.
- Replace lens (2B) and engage each lens latches (2A, 3x or 5x).
- WARNING** Product must be used only with lens intact and all lens latches fully engaged. Replace cracked or damaged lens prior to use.

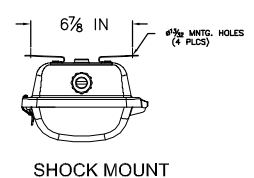
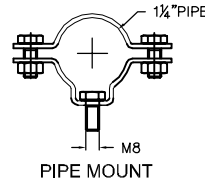
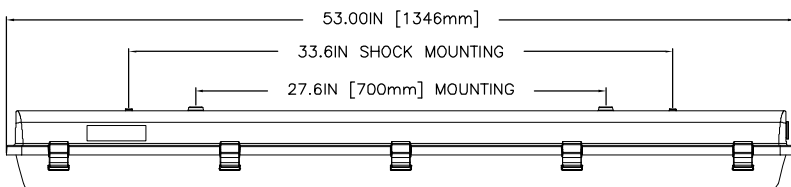
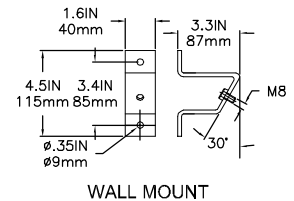
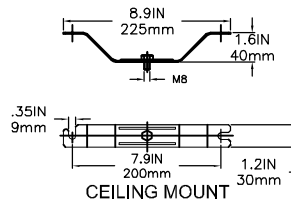
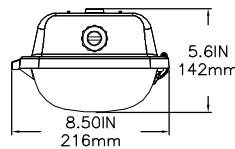
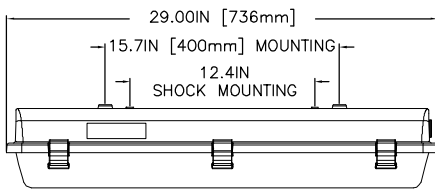
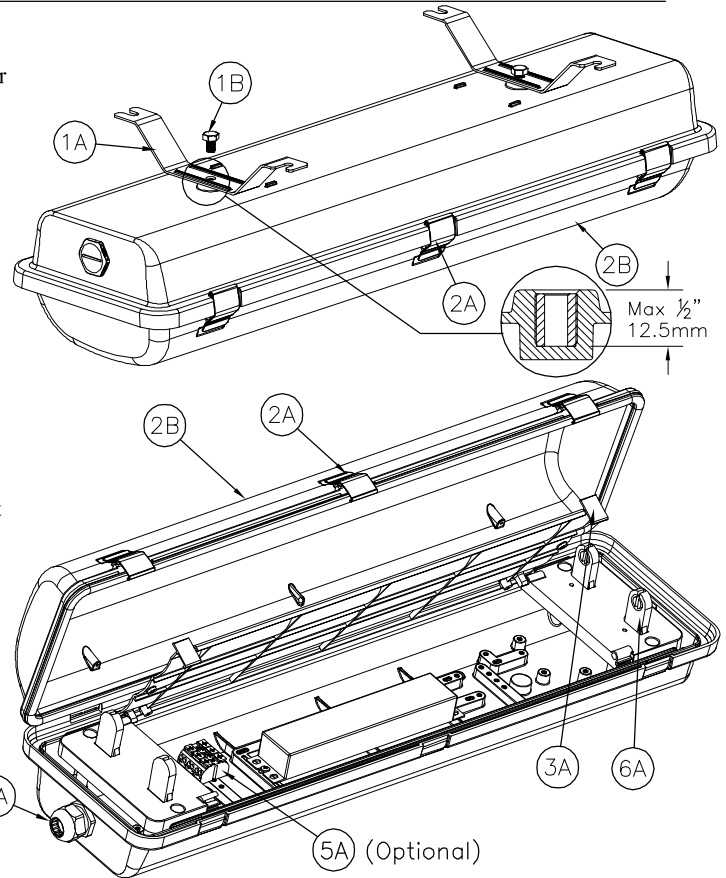

All statements, technical information and recommendations contained herein are based on information and tests we believe to be reliable. The accuracy or completeness thereof are not guaranteed. In accordance with Crouse-Hinds "Terms and Conditions of Sale", and since conditions of use are outside our control, the purchaser should determine the suitability of the product for his intended use and assumes all risk and liability whatsoever in connection therewith.