

Explosion-protected recessed ceiling LED-light and fluorescent light fittings

LED 600, RLF LED 1200 and self-contained emergency luminaire RLF LED 600 N, RLF LED 1200 N RLF/RLF-INOX 250 18 - 58 W / RLF/RLF-INOX 250... N 18 - 36 W (Zone 1, 2, 21, 22)

The explosion-protected lighting concept for recessed ceiling light fittings.

The new Ex recessed-ceiling light fittings RLF ..LED completes the portfolio together with the RLF 250... for spraying cabinets and paint shops for installation in ceilings where smooth and flush surfaces are important. The glass pane, which is installed with a metal hinge, allows the use of cleaning solvents, if necessary, in order to remove easily spray mist and paintbrushes. Similar requirements are also encountered in the pharmaceutical and chemical industries as well as in technology labs, where simple cleaning and smooth design are essential.

Designed for easy installation

The housing comprises white-painted steel sheet with an optional cover frame for ceiling mounting. In addition, it can also be fixed by means of two M8 drilled holes on the top of the housing.

Optional a **stainless steel enclosure** is available on request. For an external PE-connection two screw terminals up to 6 mm² are available.



The hinged, frameless pane made of 5 mm thick safety glass is fixed with 2 resp. 3 captive screws and has inside hinges. The EPDM sealing ensures the high degree of protection IP65.

Long-term safety

Thanks to its large input voltage range the electronic driver (110- 254 A AC / 220- 250 V DC) can be used internationally. Due to the low self-heating, ambient temperatures up to +60 ° C are possible. The fluorescent version RLF 250 .. contains a wide range voltage dual-channel electronic ballast with EOL circuit.

Versatile light

Depending on the application, three luminous flux versions are available in efficient LED technology (2500/5000/10000 lm) in various sizes. Through their variety even demanding lighting tasks can be faced. In addition, the light colour 6000K ensures an illumination similar to daylight, which is a high priority, for example, in paint shops. Using traditional fluorescent lamps the RLF 250... series combines light output with easy re-lamping.



Using optional mounting brackets the luminaires can be installed adjustable on walls or ceilings

Easy to install

The double-sided through-wiring in combination with the generous connecting space provides a cost-saving installation.

If you need a reliable and decentralised emergency lighting

The self-contained emergency light fitting RLF LED... N or RLF 250 ... N ensures decentralised emergency lighting, independent of central systems. These luminaires offers in particular significant cost advantages, particularly in large-scale installations.

























The self-contained emergency light fitting with integrated battery allows an autonomous emergency lighting with 1.5 h or 3 h rated operating time.



Features



- Universal electronic driver for 110 - 254 V AC / 220 - 250 V DC (LED) and electronic ballast for fluorescent lamps
- Various lumen packages for LED up to 9180 lm in different sizes available
- Suitable for high ambient temperatures up to +60 ° C (LED)
- Flush installation, especially for spraying cabinets and paint shops with optional mounting bracket
- Toughened safety glass
- Stainless steel enclosure on request
- With self-contained battery unit (RLF LED...N and RLF 250... N)
- Suitable for B15 fire resistance ceilings

Ordering details



Type	Content	Luminous flux	Emergency lighting duration	Cable gland/ thread	Screw plugs	Order No.	
RLF LED 600							
	RLF LED 600 2L	2/5-2K	2490 lm	1 x M25, Plastic cable gland	1 x M25	1 2285 006 001	
	RLF LED 600 2L	2/5-2M ¹⁾	2490 lm	2 x M20, Metal thread	1 x M20	1 2285 006 003	
	RLF LED 600 5L	2/5-2K	4540 lm	1 x M25, Plastic cable gland	1 x M25	1 2285 006 002	
	RLF LED 600 5L	2/5-2M ¹⁾	4540 lm	2 x M20, Metal thread	1 x M20	1 2285 006 004	
RLF LED 1200							
	RLF LED 1200 5L	2/5-2K	4860 lm	1 x M25, Plastic cable gland	1 x M25	1 2285 012 001	
	RLF LED 1200 5L	2/5-2M ¹⁾	4860 lm	2 x M20, Metal thread	1 x M20	1 2285 012 003	
	RLF LED 1200 10L	2/5-2K	9180 lm	1 x M20, Plastic cable gland	1 x M25	1 2285 012 002	
	RLF LED 1200 10L	2/5-2M ¹⁾	9180 lm	2 x M20, Metal thread	1 x M20	1 2285 012 004	
RLF LED 600 N (self-contained emergency light fitting)							
	RLF LED 600 N 2L	2/4-2K	2490 lm	1.5 h	1 x M25, plastic cable gland	1 x M25	1 2285 006 201
	RLF LED 600 N 2L	2/5-2M ¹⁾	2490 lm	1.5 h	2 x M20, Metal thread	1 x M20	1 2285 006 202
	RLF LED 600 N 2L	2/5-2K	2490 lm	3 h	1 x M25, Plastic cable gland	1 x M25	1 2285 006 301
	RLF LED 600 N 2L	2/5-2M ¹⁾	2490 lm	3 h	2 x M20, Metal thread	1 x M20	1 2285 006 302
	RLF LED 600 N 5L	2/5-2K	4540 lm	1.5 h	1 x M25, Plastic cable gland	1 x M25	1 2285 006 203
	RLF LED 600 N 5L	2/5-2M ¹⁾	4540 lm	1.5 h	2 x M20, Metal thread	1 x M20	1 2285 006 204
	RLF LED 600 N 5L	2/5-2K	4540 lm	3 h	1 x M25, Plastic cable gland	1 x M25	1 2285 006 303
	RLF LED 600 N 5L	2/5-2M ¹⁾	4540 lm	3 h	2 x M20, Metal thread	1 x M20	1 2285 006 304
RLF LED 1200 N (self-contained emergency light fitting)							
	RLF LED 1200 N 5L	2/5-2K	4860 lm	1.5 h	1 x M25, Plastic cable gland	1 x M25	1 2285 012 201
	RLF LED 1200 N 5L	2/5-2M ¹⁾	4860 lm	1.5 h	2 x M20, Metal thread	1 x M20	1 2285 012 202
	RLF LED 1200 N 5L	2/5-2K	4860 lm	3 h	1 x M25, Plastic cable gland	1 x M25	1 2285 012 301
	RLF LED 1200 N 5L	2/5-2M ¹⁾	4860 lm	3 h	2 x M20, Metal thread	1 x M20	1 2285 012 302
	RLF LED 1200 N 10L	2/5-2K	9180 lm	1.5 h	1 x M25, Plastic cable gland	1 x M25	1 2285 012 203
	RLF LED 1200 N 10L	2/5-2M ¹⁾	9180 lm	1.5 h	2 x M20, Metal thread	1 x M20	1 2285 012 204
	RLF LED 1200 N 10L	2/5-2K	9180 lm	3 h	1 x M25, Plastic cable gland	1 x M25	1 2285 012 303
	RLF LED 1200 N 10L	2/5-2M ¹⁾	9180 lm	3 h	2 x M20, Metal thread	1 x M20	1 2285 012 304

Scope of delivery with LED and without fixing accessories
Metal cable glands see catalogue part 2: 2.3.12 ff

Ordering details

Type	Content	Terminals	Through-wiring single-ended	Through-wiring twin-ended	Cable gland/ thread	Screw plugs	Blanking plug	Order No.
RLF 250../.. (twin lamp)								
	RLF 25018/18 (2 x 18 W)	2/5-2K	2 x 5	–	x	2 x M25, plastic	1	1 2283 218 001
	RLF 25018/18 (2 x 18 W)	2/5-2M ¹⁾	2 x 5	–	x	2 x M20, metal thread	1 x M20	1 2283 218 002
	RLF 25036/36 (2 x 36 W)	2/5-2K	2 x 5	–	x	2 x M25, plastic	1	1 2283 236 001
	RLF 25036/36 (2 x 36 W)	2/5-2M ¹⁾	2 x 5	–	x	2 x M20, metal thread	1 x M20	1 2283 236 002
	RLF 25058/58 (2 x 58 W)	2/5-2K	2 x 5	–	x	2 x M25, plastic	1	1 2283 258 001
	RLF 25058/58 (2 x 58 W)	2/5-2M ¹⁾	2 x 5	–	x	2 x M20, metal thread	1 x M20	1 2283 258 002
RLF 2503.. (three lamps)								
	RLF 250336 (3 x 36 W)	2/5-2K	2 x 5	–	x	2 x M25, plastic	1	1 2283 336 011
	RLF 250336 (3 x 36 W)	2/5-2M ¹⁾	2 x 5	–	x	2 x M20, metal thread	1 x M20	1 2283 336 012
	RLF 250358 (3 x 58 W)	2/5-2K	2 x 5	–	x	2 x M25, plastic	1	1 2283 358 011
	RLF 250358 (3 x 58 W)	2/5-2M ¹⁾	2 x 5	–	x	2 x M20, metal thread	1 x M20	1 2283 358 012
RLF 2504.. (four lamps)								
	RLF 250418 (4 x 18 W)	2/5-2K	2 x 5	–	x	2 x M25, plastic	1	1 2283 418 011
	RLF 250418 (4 x 18 W)	2/5-2M ¹⁾	2 x 5	–	x	2 x M20, metal thread	1 x M20	1 2283 418 012
	RLF 250436 (4 x 36 W)	2/5-2K	2 x 5	–	x	2 x M25, plastic	1	1 2283 436 011
	RLF 250436 (4 x 36 W)	2/5-2M ¹⁾	2 x 5	–	x	2 x M20, metal thread	1 x M20	1 2283 436 012
	RLF 250458 (4 x 58 W)	2/5-2K	2 x 5	–	x	2 x M25, plastic	1	1 2283 458 011
	RLF 250458 (4 x 58 W)	2/5-2M ¹⁾	2 x 5	–	x	2 x M20, metal thread	1 x M20	1 2283 458 012

Ordering details

Type	Content	Emergency lighting duration	Terminals	Through-wiring single-ended	Through-wiring twin-ended	Cable gland/ thread	Screw plugs	Order No.	
RLF 250../.. N (twin lamp)									
	RLF 25018/18 N (2 x 18 W)	2/6-2K	1.5 h	2 x 6	–	x	2 x M25, plastic	1 x M25	1 2283 218 201
	RLF 25018/18 N (2 x 18 W)	2/6-2M	1.5 h	2 x 6	–	x	2 x M20 x 1.5, metal thread	1 x M20	1 2283 218 202
	RLF 25018/18 N (2 x 18 W)	2/6-2K	3 h	2 x 6	–	x	2 x M25, plastic	1 x M25	1 2283 218 301
	RLF 25018/18 N (2 x 18 W)	2/6-2M	3 h	2 x 6	–	x	2 x M20 x 1.5, metal thread	1 x M20	1 2283 218 302
	RLF 25036/36 N (2 x 36 W)	2/6-2K	1.5 h	2 x 6	–	x	2 x M25, plastic	1 x M25	1 2283 236 201
	RLF 25036/36 N (2 x 36 W)	2/6-2M	1.5 h	2 x 6	–	x	2 x M20 x 1.5, metal thread	1 x M20	1 2283 236 202
	RLF 25036/36 N (2 x 36 W)	2/6-2K	3 h	2 x 6	–	x	2 x M25, plastic	1 x M25	1 2283 236 301
	RLF 25036/36 N (2 x 36 W)	2/6-2M	3 h	2 x 6	–	x	2 x M20 x 1.5, metal thread	1 x M20	1 2283 236 302
RLF 2504.. N (four lamps)									
	RLF 250418 N (4 x 18 W)	2/6-2K	1.5 h	2 x 6	–	x	2 x M25, plastic	1 x M25	1 2283 418 201
	RLF 250418 N (4 x 18 W)	2/6-2M	1.5 h	2 x 6	–	x	2 x M20 x 1.5, metal thread	1 x M20	1 2283 418 202
	RLF 250418 N (4 x 18 W)	2/6-2K	3 h	2 x 6	–	x	2 x M25, plastic	1 x M25	1 2283 418 301
	RLF 250418 N (4 x 18 W)	2/6-2M	3 h	2 x 6	–	x	2 x M20 x 1.5, metal thread	1 x M20	1 2283 418 302
	RLF 250436 N (4 x 36 W)	2/6-2K	1.5 h	2 x 6	–	x	2 x M25, plastic	1 x M25	1 2283 436 201
	RLF 250436 N (4 x 36 W)	2/6-2M	1.5 h	2 x 6	–	x	2 x M20 x 1.5, metal thread	1 x M20	1 2283 436 202
	RLF 250436 N (4 x 36 W)	2/6-2K	3 h	2 x 6	–	x	2 x M25, plastic	1 x M25	1 2283 436 301
	RLF 250436 N (4 x 36 W)	2/6-2M	3 h	2 x 6	–	x	2 x M20 x 1.5, metal thread	1 x M20	1 2283 436 302

Scope of delivery without lamp and fixing accessories
Metal cable glands see catalogue part 2: 2.3.12 ff

Accessories



Type	Application	Order No.
Mounting frame for recessed ceiling mounting	for RLF LED 600 / 600 N 2L, RLF 25018/18, 2 x 18 W	3 2283 000 001
Mounting frame for recessed ceiling mounting	for RLF LED 600 / 600 N 5L / RLF 250418, 4 x 18 W	3 2283 000 002
Mounting frame for recessed ceiling mounting	for RLF LED 1200 / 1200 N 5L / RLF 250, 2/3 x 36 W,	3 2283 000 003
Mounting frame for recessed ceiling mounting	for RLF LED 1200 / 1200 N 10L / RLF 250436, 4 x 36 W	3 2283 000 004
Mounting frame for recessed ceiling mounting	for RLF 250, 2/3 x 58 W	3 2283 000 005
Mounting frame for recessed ceiling mounting	for RLF 250458, 4 x 58 W	3 2283 000 006
Set of wall bracket adjustable (2 pcs.)	for RLF 250..	3 2283 000 007

2

Polar curve RLF... LED

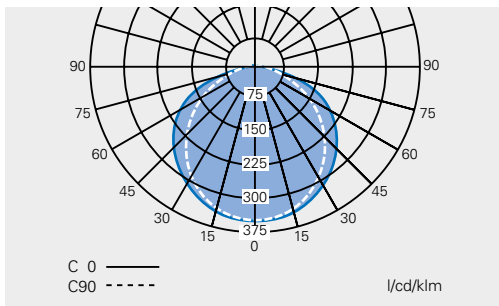

Polar curve RLF..

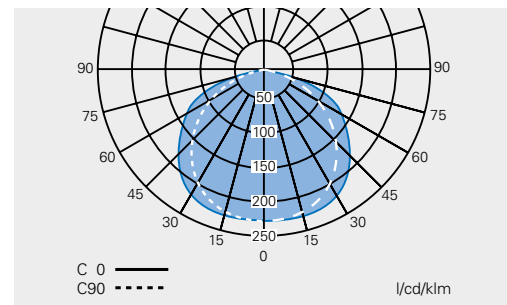

RLF LED 600 / 1200..(N) / RLF 250 ... (N)

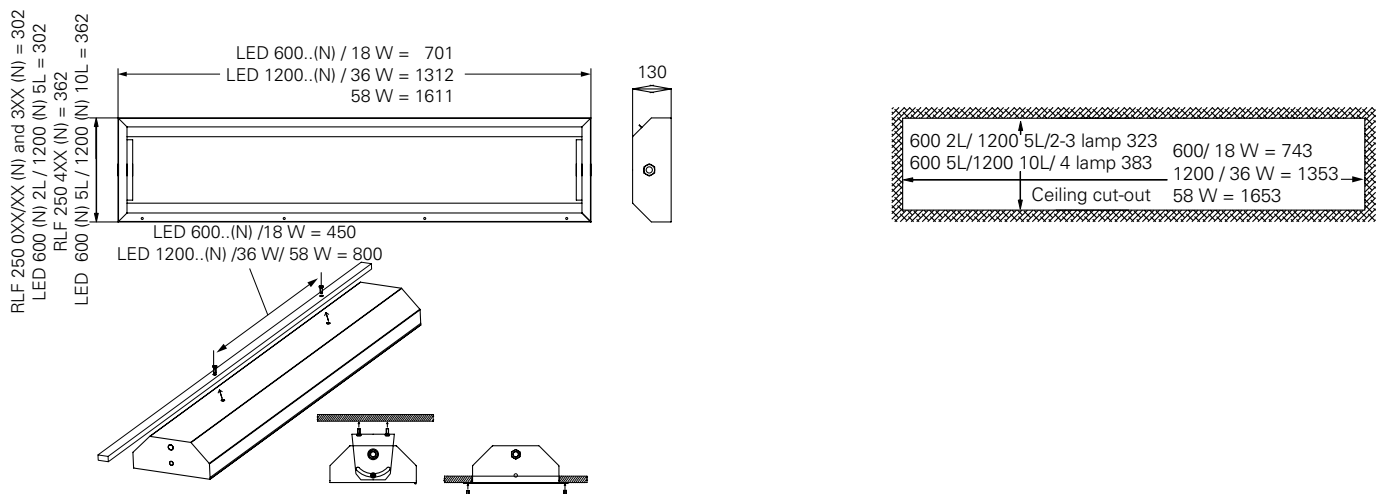

Mounting frame RLF

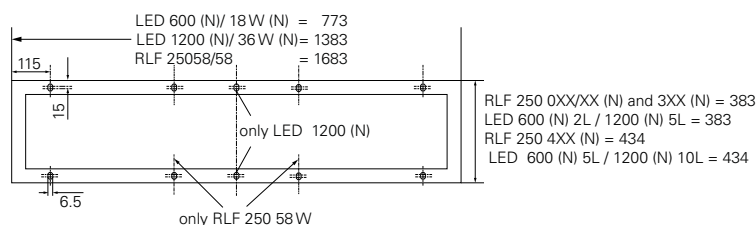

Dimensions in mm



Technical data

	RLF LED 600 2L / 5L	RLF LED 1200 5L / 10L
EU-Type Examination Certificate	FTZÚ 17 ATEX 0002X	FTZÚ 17 ATEX 0002X
Marking accd. to 2014/34/EU	Ⓜ II 2 G Ex eb mb op is IIC T4 Gb Ⓜ II 2 D Ex tb IIIC T67°C Db	Ⓜ II 2 G Ex eb mb op is IIC T4 Gb Ⓜ II 2 D Ex tb IIIC T67°C Db
Permissible ambient temperature	-20 °C up to +60 °C	-20 °C up to +55 °C
Rated voltage	110 - 254 V AC / 220 - 250 V DC	110 - 254 V AC / 220 - 250 V DC
Rated current	0.13 A / 0.26 A at 230 V	0.24 A / 0.48 A at 230 V
Frequency	50 - 60 Hz	50 - 60 Hz
Power factor cos φ	≥ 0.95	≥ 0.95
Circuit	electronic LED-driver	electronic LED-driver
Protection class	I	I
Lamp / Illuminant	LED module 1 x 25 W / 2 x 25 W	LED module 1 x 50 W / 2 x 50 W
Rated luminous flux of the luminaire	2490 lm (2L) / 4540 lm (5L)	4860 lm (5L) / 9180 lm (10L)
Light colour/ CRI	6000 K / R _a >70 ²⁾	6000 K / R _a >70 ²⁾
Dimensions (L x W x H)	701 x 302 x 130 mm / 701 x 362 x 130 mm	1312 x 302 x 130 mm / 1312 x 362 x 130 mm
Connecting terminals	L1, L2, L3, N, PE; max. 2 x 2.5 mm ² twin-ended through-wiring	L1, L2, L3, N, PE; max. 2 x 2.5 mm ² twin-ended through-wiring
Enclosure colour	white RAL 9010	white RAL 9010
Enclosure material	painted steel sheet, white optional: polished stainless steel 304 (1.4301)	painted steel sheet, white optional: polished stainless steel 304 (1.4301)
Weight	9.5 kg (2L) / 11.9 kg (5L)	15.6 kg (5L) / 18.4 kg (10L)
Cable glands / gland plates / enclosure drilling	Ex-e cable glands M25 x 1.5 (plastic), option: M20 x 1.5 metal thread ¹⁾	Ex-e cable glands M25 x 1.5 (plastic), option: M20 x 1.5 metal thread ¹⁾
Degree of protection accd. to EN 60529	IP65	IP65
Protective cover / protective bowl	single-safety glass pane of 5 mm thick	single-safety glass pane of 5 mm thick

1) with dustcover if entry/thread is not closed

2) 4000 K on request



2

Technical data

	RLF LED 600 N 2L / 5L	RLF LED 1200 N 5L / 10L
EU-Type Examination Certificate	FTZÚ 17 ATEX 0002X	FTZÚ 17 ATEX 0002X
Marking accd. to 2014/34/EU	Ⓜ II 2 G Ex eb mb op is IIC T4 Gb Ⓜ II 2 D Ex tb IIIC T67°C Db	Ⓜ II 2 G Ex eb mb op is IIC T4 Gb Ⓜ II 2 D Ex tb IIIC T67°C Db
Permissible ambient temperature	0 °C up to +40 °C	0 °C up to +35 °C
Rated voltage	110 - 254 V AC / 220 - 250 V DC	110 - 254 V AC / 220 - 250 V DC
Rated current	0.14 A / 0.26 A at 230 V	0.25 A / 0.49 A at 230 V
Frequency	50 - 60 Hz	50 - 60 Hz
Power factor cos φ	≥ 0.95	≥ 0.95
Circuit	electronic LED-driver	electronic LED-driver
Protection class	I	I
Lamp / Illuminant	LED module 1 x 25 W / 2 x 25 W	LED module 1 x 50 W / 2 x 50 W
Rated luminous flux of the luminaire	2490 lm (2L) / 4540 lm (5L)	4860 lm (5L) / 9180 lm (10L)
Light colour/ CRI	6000 K / R _a >70 ²⁾	6000 K / R _a >70 ²⁾
luminous flux in emergency mode		
1.5 h, one LED module	375 lm	534 lm
3 h, one LED module	249 lm	291 lm
Emergency lighting duration	1.5 h or 3 h	1.5 h or 3 h
Dimensions (L x W x H)	701 x 302 x 130 mm / 701 x 362 x 130 mm	1312 x 302 x 130 mm / 1312 x 362 x 130 mm
Connecting terminals	L, L1,L2, L3, N, PE; max. 2 x 2.5 mm ² twin-ended through-wiring	L, L1,L2, L3, N, PE; max. 2 x 2.5 mm ² twin-ended through-wiring
Enclosure colour	white RAL 9010	white RAL 9010
Enclosure material	painted steel sheet, white optional: polished stainless steel 304 (1.4301)	painted steel sheet, white optional: polished stainless steel 304 (1.4301)
Weight	11,50 kg 2L (1,5h)/ 12,10 kg 2L (3h) 13,60 kg 5L (1,5h)/ 14,80 kg 5L (3h)	16,40 kg 5L (1,5h)/ 18,40 kg 5L (3h) 18,50 kg 10L (1,5h)/ 19,10 kg 10L (3h)
Cable glands / gland plates / enclosure drilling	Ex-e cable glands M25 x 1.5 (plastic) , option: M20 x 1.5 metal thread ¹⁾	Ex-e cable glands M25 x 1.5 (plastic) , option: M20 x 1.5 metal thread ¹⁾
Degree of protection accd. to EN 60529	IP65	IP65
Protective cover / protective bowl	single-safety glass pane of 5 mm thick	single-safety glass pane of 5 mm thick

1) with dustcover if entry/thread is not closed

2) 4000 K on request



Technical data

	RLF 25018/18 / RLF 250418	RLF 25036/36 / RLF 250336
EC-Type Examination Certificate	FTZU 06 ATEX 0050 X	FTZU 06 ATEX 0050 X
Marking accd. to 2014/34/EU	⊕ II 2 G Ex ed IIC T4 Gb ⊕ II 2 D Ex tb IIIC T60 °C Db	⊕ II 2 G Ex ed IIC T4 ⊕ II 2 D Ex tb IIIC T60 °C Db
Permissible ambient temperature	-20 °C up to +40 °C	-20 °C up to +40 °C
Rated voltage	110 - 250 V AC / 110 - 250 V DC	110 - 250 V AC / 110 - 250 V DC
Rated current	0.18 A / 0.36 A	0.34 A / 0.51 A
Frequency	50 - 60 Hz	50 - 60 Hz
Power factor cos φ	≥ 0.95	≥ 0.95
Circuit	EVG	EVG
Protection class	I	I
Lamp / Illuminant	2 x T26 / 18 W (T8) / 4 x T26 / 18 W (T8)	2 x T26 / 36 W (T8) / 3 x T26 / 36 W (T8)
Rated luminous flux	2700 lm ¹⁾ / 5400 lm ¹⁾	6700 lm ¹⁾ / 10050 lm ¹⁾
Lamp cap	G13 accd. to IEC 60061-1	G13 accd. to IEC 60061
Light output ratio	70 % / 69 %	70 % / 68 %
Dimensions (L x W x H)	701 x 302 x 130 mm / 701 x 362 x 130 mm	1312 x 302 x 130 mm
Connecting terminals	L1, L2, L3, N, PE; max. 2 x 2.5 mm ² through-wiring twin-ended	L1, L2, L3, N, PE; max. 2 x 2.5 mm ² through-wiring twin-ended
Enclosure colour	white RAL 9010	white RAL 9010
Enclosure material	painted steel sheet, white optional: polished stainless steel 304 (1.4301)	painted steel sheet, white optional: polished stainless steel 304 (1.4301)
Weight	6.9 kg / 9.5 kg	12.9 kg / 13.4 kg
Cable glands / gland plates / enclosure drilling	Ex-e cable glands M25 x 1.5 (plastic) , option: M20 x 1.5 metal thread ²⁾	Ex-e cable glands M25 x 1.5 (plastic) , option: M20 x 1.5 metal thread ²⁾
Degree of protection accd. to EN 60529	IP65	IP65
Protective cover / protective bowl	single-safety glass pane of 5 mm thick	single-safety glass pane of 5 mm thick

¹⁾ depends on used lamps²⁾ with dustcover if entry/thread is not closed



Technical data

	RLF 250436	RLF 25058/58
EC-Type Examination Certificate	FTZU 06 ATEX 0050 X	FTZU 06 ATEX 0050 X
Marking accd. to 2014/34/EU	Ⓜ II 2 G Ex ed IIC T4 Ⓜ II 2 D Ex tb II IC T60 °C Db	Ⓜ II 2 G Ex ed IIC T4 Ⓜ II 2 D Ex tb IIIC T60 °C Db
Permissible ambient temperature	-20 °C up to +40 °C	-20 °C up to +40 °C
Rated voltage	110 - 250 V AC / 110 - 250 V DC	220 - 250 V AC / 195 - 250 V DC
Rated current	0.68 A	0.53 A
Frequency	50 - 60 Hz	50 - 60 Hz
Power factor cos φ	≥ 0.95	≥ 0.95
Circuit	EVG	EVG
Protection class	I	I
Lamp / Illuminant	4 x T26 / 36 W (T8)	2 x T26 / 58 W (T8)
Rated luminous flux	13400 lm ¹⁾	10400 lm ¹⁾
Lamp cap	G13 accd. to IEC 60061-1	G13 accd. to IEC 60061-1
Light output ratio	69 %	68 %
Dimensions (L x W x H)	1312 x 362 x 130 mm	1611 x 302 x 130 mm
Connecting terminals	L1, L2, L3, N, PE; max. 2 x 2.5 mm ² through-wiring twin-ended	L1, L2, L3, N, PE; max. 2 x 2.5 mm ² through-wiring twin-ended
Enclosure colour	white RAL 9010	white RAL 9010
Enclosure material	painted steel sheet, white optional: polished stainless steel 304 (1.4301)	painted steel sheet, white optional: polished stainless steel 304 (1.4301)
Weight	16.5 kg	17.2 kg
Cable glands / gland plates / enclosure drilling	Ex-e cable glands M25 x 1.5 (plastic) , option: M20 x 1.5 metal thread ²⁾	Ex-e cable glands M25 x 1.5 (plastic) , option: M20 x 1.5 metal thread ²⁾
Degree of protection accd. to EN 60529	IP65	IP65
Protective cover / protective bowl	single-safety glass pane of 5 mm thick	single-safety glass pane of 5 mm thick

¹⁾ depends on used lamps

²⁾ with dustcover if entry/thread is not closed



Technical data

	RLF 250358	RLF 250458
EC-Type Examination Certificate	FTZU 06 ATEX 0050 X	FTZU 06 ATEX 0050 X
Marking accd. to 2014/34/EU	Ⓜ II 2 G Ex ed IIC T4 Ⓜ II 2 D Ex tb IIIC T60 °C Db	Ⓜ II 2 G Ex ed IIC T4 Gb Ⓜ II 2 D Ex tb IIIC T60 °C Db
Permissible ambient temperature	-20 °C up to +40 °C	-20 °C up to +40 °C
Rated voltage	220 - 250 V AC / 195 - 250 V DC	220 - 250 V AC / 195 - 250 V DC
Rated current	0.80 A	1.06 A
Frequency	50 - 60 Hz	50 - 60 Hz
Power factor cos φ	≥ 0.95	≥ 0.95
Circuit	EVG	EVG
Protection class	I	I
Lamp / Illuminant	3 x T26 / 58 W (T8)	4 x T26 / 58 W (T8)
Rated luminous flux	15600 lm ¹⁾	20800 lm ¹⁾
Lamp cap	G13 accd. to IEC 60061-1	G13 accd. to IEC 60061-1
Light output ratio	66 %	67 %
Dimensions (L x W x H)	1611 x 302 x 130 mm	1611 x 362 x 130 mm
Connecting terminals	L1, L2, L3, N, PE; max. 2 x 2.5 mm ² through-wiring twin-ended	L1, L2, L3, N, PE; max. 2 x 2.5 mm ² through-wiring twin-ended
Enclosure colour	white RAL 9010	white RAL 9010
Enclosure material	painted steel sheet, white optional: polished stainless steel 304 (1.4301)	painted steel sheet, white optional: polished stainless steel 304 (1.4301)
Weight	17.8 kg	19.8 Kg
Cable glands / gland plates / enclosure drilling	Ex-e cable glands M25 x 1.5 (plastic) , option: M20 x 1.5 metal thread ²⁾	Ex-e cable glands M25 x 1.5 (plastic) , option: M20 x 1.5 metal thread ²⁾
Degree of protection accd. to EN 60529	IP65	IP65
Protective cover / protective bowl	single-safety glass pane of 5 mm thick	single-safety glass pane of 5 mm thick

¹⁾ depends on used lamps

²⁾ with dustcover if entry/thread is not closed



Technical data

	RLF 25018/18 N / RLF 25036/36 N	RLF 250418 N / RLF 250436 N
EC-Type Examination Certificate	FTZU 06 ATEX 0050 X	FTZU 06 ATEX 0050 X
Marking accd. to 2014/34/EU	Ⓜ II 2 G Ex d e ib mb IIC T4 Gb Ⓜ II 2 D Ex tb IIIC T60 °C Db	Ⓜ II 2 G Ex d e ib mb IIC T4 Gb Ⓜ II 2 D Ex tb IIIC T60 °C Db
Permissible ambient temperature	0 °C up to +40 °C (specified data)	0 °C up to +40 °C
Battery	3.6 V/4 Ah NC-Accu / 6 V/4 Ah NC-Accu	3.6 V/4 Ah NC-Accu / 6 V/4 Ah NC-Accu
Rated voltage	230 - 240 V AC	230 - 240 V AC
Rated current	0.20 A / 0.36 A	0.36 A / 0.68 A
Frequency	50 - 60 Hz	50 - 60 Hz
Charging duration	≥ 24 h	≥ 24 h
Power factor cos φ	≥ 0.95	≥ 0.95
Circuit	EVG with emergency lighting supply	EVG with emergency lighting supply
Protection class	I	I
Lamp / Illuminant	2 x T26 / 18 W (T8) / 2 x T26 / 36 W (T8)	4 x T26 / 18 W (T8) / 4 x T26 / 36 W (T8)
Rated luminous flux	2700 lm ¹⁾ / 6700 lm ¹⁾	5400 lm ¹⁾ / 13400 lm ¹⁾
Lamp cap	G13 accd. to IEC 60061-1	G13 accd. to IEC 60061-1
Light output ratio	70 %	70 %
Luminous flux in emergency operation (1.5 h, one lamp)	270 lm (20 %) / 603 lm (18 %)	270 lm (20 %) / 603 lm (18 %)
Luminous flux in emergency operation (3 h, one lamp)	216 lm (16 %) / 436 lm (13 %)	216 lm (16 %) / 436 lm (13 %)
Rated emergency lighting duration	1.5 h / 3 h	1.5 h / 3 h
Dimensions (L x W x H)	701 x 302 x 130 mm / 1312 x 302 x 130 mm	701 x 362 x 130 mm / 1312 x 362 x 130 mm
Connecting terminals	L, L1, L2, L3, N, PE; max. 2 x 2.5 mm ² through-wiring twin-ended	L, L1, L2, L3, N, PE; max. 2 x 2.5 mm ² through-wiring twin-ended
Enclosure colour	white RAL 9010	white RAL 9010
Enclosure material	painted steel sheet, white optional polished stainless steel	painted steel sheet, white optional polished stainless steel
Weight	8.9 kg / 14.9 kg	11.5 kg / 18.5 kg
Cable glands / gland plates / enclosure drilling	Ex-e cable glands M25 x 1.5 (plastic), option: M20 x 1.5 metal thread ²⁾	Ex-e cable glands M25 x 1.5 (plastic), option: M20 x 1.5 metal thread ²⁾
Degree of protection accd. to EN 60529	IP65	IP65
Protective cover / protective bowl	single-safety glass pane of 5 mm thick	single-safety glass pane of 5 mm thick

¹⁾ depends on used lamps

²⁾ with dustcover if entry/thread is not closed