

4.4

Ex Pendant light fittings for high-pressure discharge lamps EV. / dHLS / EVZ

4 (Zone 1, 2, 21, 22)

Ex pendant light fittings for high-pressure discharge lamps

These EV, dHLS and EVZ luminaire series are designed for the use of high-pressure discharge lamps. Ballasts and lamps are located in a common housing. The flameproof enclosures are connected via an easy-to-mount Ex-e terminal compartment. The protective cover is made of borosilicate glass and is extremely impact and heat resistant. All external

screws are made of stainless steel. The lamp replacement is done by opening the PTFE coated connection ring. Both the glass dome and the connection ring are hinged for easy access. Depending on the type, the light fittings are certified for ambient temperatures from -45 °C up to 55 °C.



EV pendant light fitting with 2 housing sizes

The EV pendant light series is suitable for use with sodium or metal halide high-pressure discharge lamps. The small enclosure solution can be used with lamps up to 125 W. The large enclosure solution is suitable for lamps with a power consumption of up to 250 W.

al safety, it has been used in chemical plants and on- and offshore platforms for illuminating large areas and selective large objects for many years now. The light fitting is fitted with a dome-shaped glass cover and can also be fitted with an external reflector.

EVZ - highly versatile

The EVZ pendant light fittings are available in 2 versions for 70 W to 150 W and 150 W to 400 W. The luminaire can be fitted with a swivel bracket for wall or pole mounting. Two external reflectors and a protective guard are available as an option.

dHLS – the robust pendant light

The robust dHLS pendant light fitting has been certified for hazardous areas in Zones 1 and 2 and is suitable for 250 W and 400 W high pressure lamps . The housing is made of a light alloy with a powder coating. Because of its high operation-

Features

- Various enclosure-size solutions
- For high-pressure discharge lamps
- Robust design for harsh environments
- Large Ex-e terminal compartment
- Wide ambient temperature range depending on the version from -45 ° C up to +55 ° C
- CU-Certificate for Eurasian Economic Community available
- Meets the highest standards of corrosion protection and mechanical strength



Ordering details

Type	Lamp / Illuminant	Rated luminous flux ²⁾	Weight	Metal thread/ plastic cable gland	Threaded plug	Dust cap	Order No.
EV ...							
EVS 70 ZM	HSE 70 W	5600 lm	14 kg	2 x M25	1 x M25 Ex-e	x	NOR 000 115 110 880
EVS 70 ZM, -45 °C up to +55 °C	HSE 70 W	5600 lm	14 kg	2 x M25	1 x M25 Ex-e	x	NOR 000 115 110 886
EVS 150 ZM	HSE 150 W	14000 lm	22.4 kg	2 x M25	1 x M25 Ex-e	x	NOR 000 115 110 883
EVS 150 ZM, -45 °C up to +55 °C	HSE 150 W	14000 lm	22.4 kg	2 x M25	1 x M25 Ex-e	x	NOR 000 115 110 887
EVS 250 ZM	HSE 250 W	25000 lm	22.4 kg	2 x M25	1 x M25 Ex-e	x	NOR 000 115 110 882
EVS 250 ZM, -45 °C up to +55 °C	HSE 250 W	25000 lm	22.4 kg	2 x M25	1 x M25 Ex-e	x	NOR 000 115 110 888
EVH 250 ZM	HIE 250 W	17000 lm	22.4 kg	2 x M25	1 x M25 Ex-e	x	NOR 000 115 110 945
EVH 250 ZM, -45 °C up to +55 °C	HIE 250 W	17000 lm	22.4 kg	2 x M25	1 x M25 Ex-e	x	NOR 000 115 110 889
dHLS 85 ...							
dHLS 85250 HSE IND	HSE 250 W	25000 lm	30 kg	1 x M25 plastic	1 x M25 Ex-e	x	CGS 123 8688 P2001
dHLS 85250 HSE KOMP ¹⁾	HSE 250 W	25000 lm	37 kg	1 x M25 plastic	1 x M25 Ex-e	x	CGS 123 8688 P3001
dHLS 85400 HSE IND	HSE 400 W	48000 lm	30 kg	1 x M25 plastic	1 x M25 Ex-e	x	CGS 123 8788 P2001
dHLS 85400 HSE KOMP ¹⁾	HSE 400 W	48000 lm	37 kg	1 x M25 plastic	1 x M25 Ex-e	x	CGS 123 8788 P3001
dHLS 85400 HSE IND, -50 °C up to +50 °C	HSE 400 W	48000 lm	30 kg	1 x M25 plastic	1 x M25 Ex-e	x	CGS 123 8788 P2002
EVZ small enclosure							
EVZIS2M075 - 230 V AC	HSE 70 W	5600 lm	10 kg	2 x M25	1 x M25 Ex-e	x	CCL 1077 028 /S6E
EVZIS2M076 - 240 V AC	HSE 70 W	5600 lm	10 kg	2 x M25	1 x M25 Ex-e	x	CCL 1077 040 /S6E
EVZIS2M105 - 230 V AC	HSE 100 W	8800 lm	11 kg	2 x M25	1 x M25 Ex-e	x	CCL 1077 088 /S6E
EVZIS2M106 - 240 V AC	HSE 100 W	8800 lm	11 kg	2 x M25	1 x M25 Ex-e	x	CCL 1077 100 /S6E
EVZIS2M155 - 230 V AC	HSE 150 W	14000 lm	12 kg	2 x M25	1 x M25 Ex-e	x	CCL 1077 148 /S6E
EVZIS2M156 - 240 V AC	HSE 150 W	14000 lm	12 kg	2 x M25	1 x M25 Ex-e	x	CCL 1077 160 /S6E
EVZIM2M075 - 230 V AC	HIE 70 W	5100 lm	10 kg	2 x M25	1 x M25 Ex-e	x	CCL 1077 034 /S6E
EVZIM2M076 - 240 V AC	HIE 70 W	5100 lm	10 kg	2 x M25	1 x M25 Ex-e	x	CCL 1077 046 /S6E
EVZIM2M105 - 230 V AC	HIE 100 W	7800 lm	11 kg	2 x M25	1 x M25 Ex-e	x	CCL 1077 094 /S6E
EVZIM2M106 - 240 V AC	HIE 100 W	7800 lm	11 kg	2 x M25	1 x M25 Ex-e	x	CCL 1077 106 /S6E
EVZIM2M155 - 230 V AC	HIE 150 W	11000 lm	12 kg	2 x M25	1 x M25 Ex-e	x	CCL 1077 154 /S6E
EVZIM2M156 - 240 V AC	HIE 150 W	11000 lm	12 kg	2 x M25	1 x M25 Ex-e	x	CCL 1077 166 /S6E

¹⁾ with installed ballast enclosure on top $\cos \varphi \geq 0.9$

²⁾ depends on used lamps

Scope of delivery without lamp and fixing accessories, if not stated otherwise.

Metal cable glands see catalogue part 2: 2.3.12 ff



4.4

Ordering details / Accessories

Pendant light fittings

Ordering details

Type	Lamp / Illuminant	Rated luminous flux ²⁾	Weight	Metal thread	Threaded plug	Dust cap	Order No.
EVZ large enclosure							
EVZIS2M255 - 230 V AC	HSE 250 W	25000 lm	16 kg	2 x M25	1 x M25 Ex-e	x	CCL 1075 088 /S6E
EVZIS2M256 - 240 V AC	HSE 250 W	25000 lm	16 kg	2 x M25	1 x M25 Ex-e	x	CCL 1075 100 /S6E
EVZIS2M405 - 230 V AC	HSE 400 W	48000 lm	18 kg	2 x M25	1 x M25 Ex-e	x	CCL 1075 136 /S6E
EVZIS2M406 - 240 V AC	HSE 400 W	48000 lm	18 kg	2 x M25	1 x M25 Ex-e	x	CCL 1075 142 /S6E
EVZIS2M605 - 230 V AC	HST 600 W	90000 lm	20 kg	2 x M25	1 x M25 Ex-e	x	CCL 1075 196 /S6E
EVZIS2M606 - 240 V AC	HST 600 W	90000 lm	20 kg	2 x M25	1 x M25 Ex-e	x	CCL 1075 202 /S6E
EVZIM2M255 - 230 V AC	HIE 250 W	19000 lm	16 kg	2 x M25	1 x M25 Ex-e	x	CCL 1075 094 /S6E
EVZIM2M256 - 240 V AC	HIE 250 W	19000 lm	16 kg	2 x M25	1 x M25 Ex-e	x	CCL 1075 106 /S6E
EVZIM2M405 - 230 V AC	HIT 400 W	33000 lm	18 kg	2 x M25	1 x M25 Ex-e	x	CCL 1075 166 /S6E
EVZIM2M406 - 240 V AC	HIT 400 W	33000 lm	18 kg	2 x M25	1 x M25 Ex-e	x	CCL 1075 172 /S6E

²⁾ depends on used lamps

Accessories

Type	Content	Application	OU	Order No.
G. EV 200	Wire guard	EV.. small enclosure	1	CHR 2100 3
G. EV 500	Wire guard	EV.. large enclosure	1	CHR 8208 FS
PC. EV 200	External reflector	EV.. 70-125 ..	1	NOR 000 005 110 894
PC. EV 500	External reflector	EV.. 150-250 ..	1	NOR 000 005 110 901
KEY, EV	Luminaire key	EV..	1	NOR 000 005 110 886
CEV/AB	Eye bolt	EV..	1	NOR 000 005 110 852
SPU.EV/AB	Wall mounting bracket, adjustable	EV..	1	NOR 000 005 110 951
AS.EV	Ceiling bracket	EV..	1	NOR 000 005 110 828
BC. EV	Pole mounting bracket for poles Ø 44 - 64 mm	EV..and EVZ	1	NOR 000 005 110 836
SP. EV 200	Wall mounting bracket	EV 70..-125 ..	1	NOR 000 005 110 935
SP. EV 500	Wall mounting bracket	EV 150..-250 ..	1	NOR 000 005 110 943
RS	Eye bolt M10 (10 pcs.) galvanised	dHLS 85	1	GHG 690 1921 R0003
L 218	Mounting bracket for inductive version	dHLS 85	1	GHG 690 1913 R0001
L 430	Mounting bracket for compensated version	dHLS 85	1	GHG 690 1913 R0002
AR	External reflector metal, powder coating white	dHLS 85	1	CGS 223 7990 P1000
U-bracket	for ceiling- and wall mounting	EVZ - small enclosure	1	CCL 1076 001
U-bracket	for ceiling- and wall mounting	EVZ - large enclosure	1	CCL 1076 002
RA725	Asymmetrical external reflector	EVZ - small enclosure	1	750 283
RD725	Symmetrical external reflector	EVZ - small enclosure	1	7502 86
RA	Asymmetrical external reflector	EVZ - large enclosure	1	CHR 9973
RD	Symmetrical external reflector	EVZ - large enclosure	1	CHR 9972
Wire guard	Stainless steel SS316	EVZ - small enclosure	1	CHR 8138
Wire guard	Stainless steel SS316	EVZ - large enclosure	1	CHR 7870
Eye bolt		EVZ	1	CHR 6196
HSE 70 W	High pressure sodium lamp 70 W E27	EVS 70, EVZIS2M07	1	3 2475 900 012
HSE 100 W	High pressure sodium lamp 100 W E40	EVZIS2M10	1	3 2475 900 013
HSE 150 W	High pressure sodium lamp 150 W E40	EVS 150, EVZIS2M15	1	3 2475 900 014
HSE 250 W	High pressure sodium lamp 250 W E40	EVS 250, dHLS 85250, EVZIS2M25	1	CGS 3238 600 P1009
HSE 400 W	High pressure sodium lamp 400 W E40	EVS 4000, dHLS 85400, EVZIS2M40	1	CGS 3238 700 P1009
HSE 600 W	High pressure sodium lamp 600 W E40	EVZIS2M60	1	on request

Scope of delivery without lamp and fixing accessories, if not stated otherwise. Metal cable glands see catalogue part 2: 2.3.12 ff



Type	Content	Application	OU	Order No.
HIE 70 W	High pressure metal halide lamp 70 W E27	EVZIM2M07	1	3 2475 900 010
HIE 100 W	High pressure metal halide lamp 100 W E27	EVZIM2M10	1	3 2475 900 011
HIE 150 W	High pressure metal halide lamp 150 W E40	EVZIM2M15	1	on request
HIE 250 W/	High pressure metal halide lamp 250 W E40	EVH 250, EVZIM2M25	1	3 2475 900 017
HIE 400 W/	High pressure metal halide lamp 400 W E40	EVZIM2M40	1	3 2475 900 018

Scope of delivery without lamp and fixing accessories, if not stated otherwise.
Metal cable glands see catalogue part 2: 2.3.12 ff

Other lamps on request

4

Polar curve without external reflector dHLS

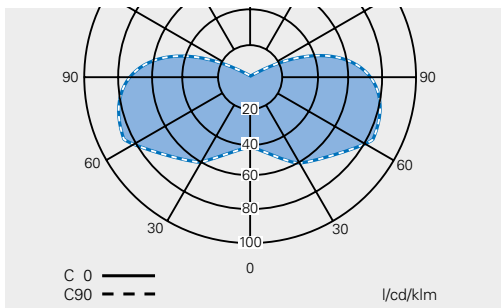

dHLS 85 ... ind.

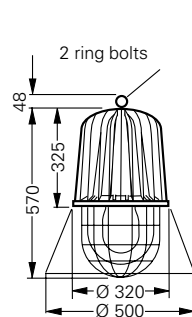

dHLS 85 ... comp.

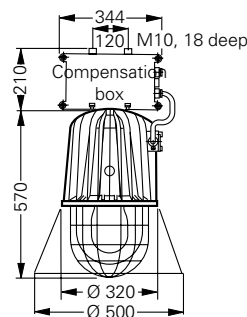

Polar curve EV 200/500 without external reflector

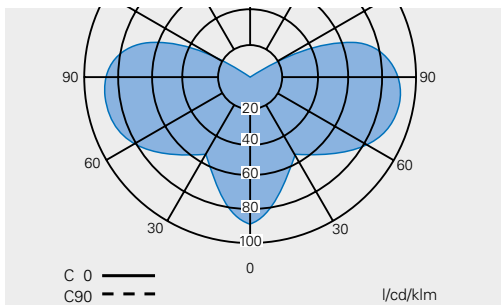

EV ... 70 - 125 ZM

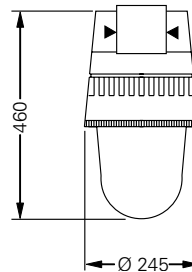

EV ... 150 - 250 ZM

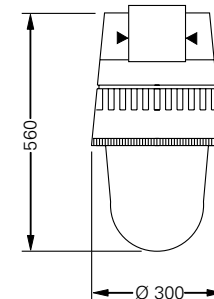

Polar curve EV 200/500 with external reflector

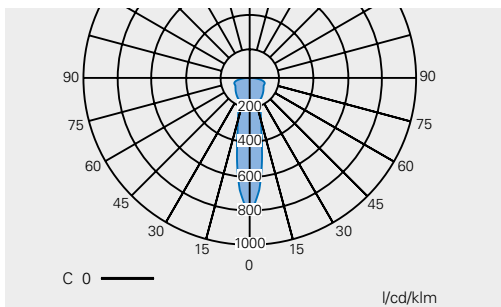

SPEV 200/500

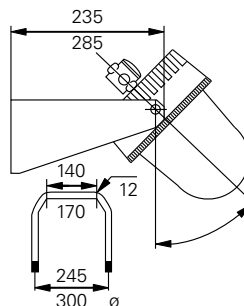

SPU EV/AB

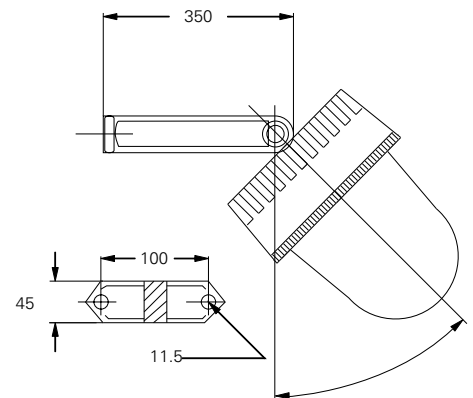

KEY.EV

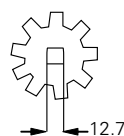

CEV/AB

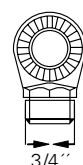

AS.EV

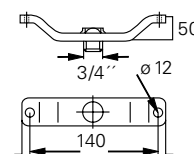

BC.EV

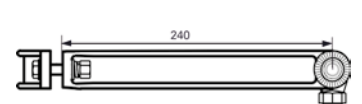

Dimensions in mm

4.4

Polar curve / Dimension drawing

Pendant light fittings

Polar curve EVZ small enclosure

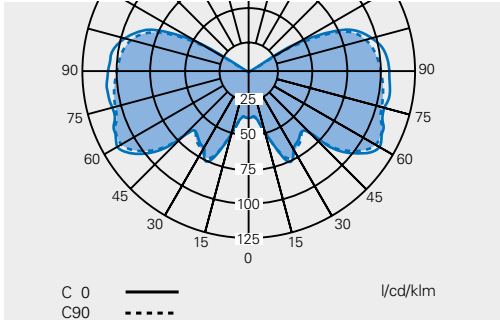

Polar curve EVZ large enclosure

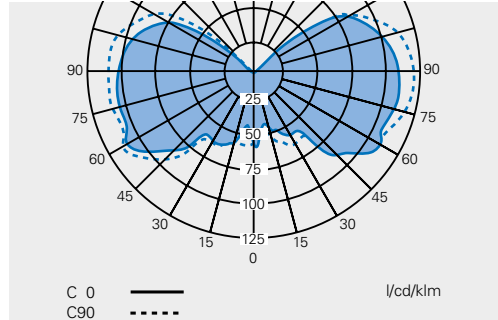

Polar curve EVZ small enclosure with reflector RD

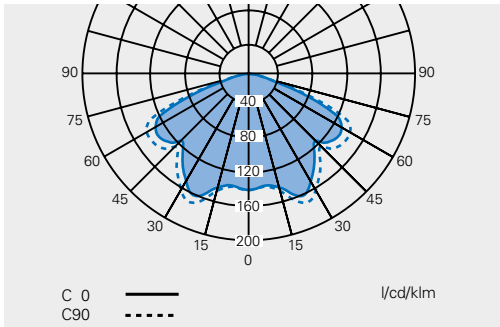

Polar curve EVZ large enclosure with reflector RD

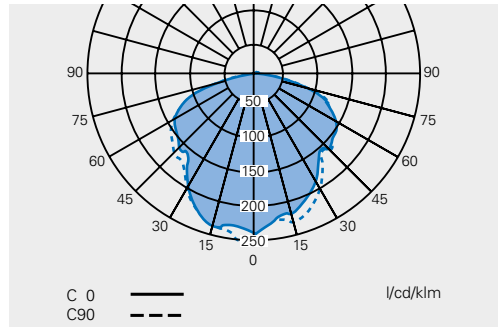

Polar curve EVZ small enclosure with reflector RA

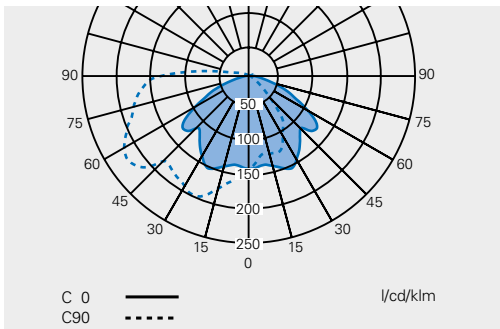

Polar curve EVZ large enclosure with reflector RA

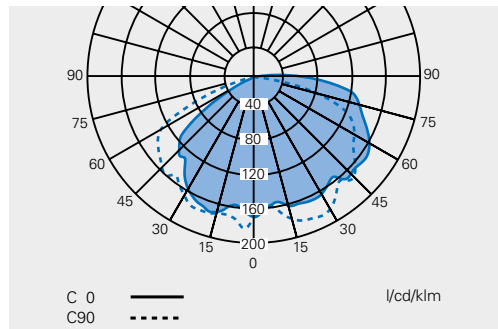

EVZ small enclosure

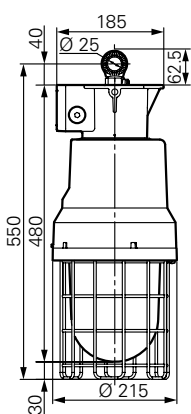

EVZ large enclosure

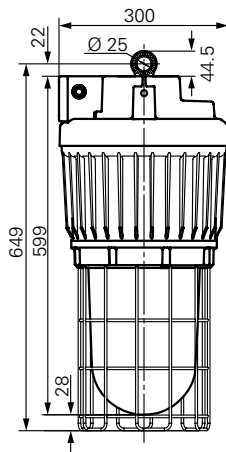

U-bracket

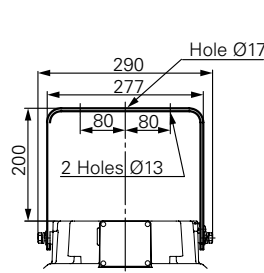

Bracket for pole mounting

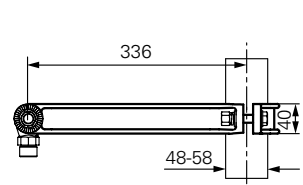

Dimensions in mm



Technical data

4

	EV ≤ 125 W (small enclosure)	EV ≤ 250 W (large enclosure)
EC-Type Examination Certificate	LOM 02 ATEX 2012 X	LOM 02 ATEX 2012 X
IECEX Certificate of Conformity	IECEX BK1 07.0031X	IECEX BK1 07.0031X
Marking accd. to 2014/34/EU	⊕ II 2 G Ex de IIC T ¹ Db ⊕ II 2 D Ex tb IIIC T...°C Db	⊕ II 2 G Ex de IIC T ¹ Db ⊕ II 2 D Ex tb IIIC T...°C Db
Marking accd. to IECEx	Ex de IIC T ¹ Gb Ex tD A21 IP67 T ¹	Ex de IIC T ¹ Ex tD A21 IP67 T ¹
Permissible ambient temperature	-20 °C up to +55 °C -45 °C up to +55 °C (option)	-20 °C up to +55 °C -45 °C up to +55 °C (option)
Rated voltage	230 V AC	230 V AC
Frequency	50 Hz	50 Hz
Power factor cos φ	≥ 0.85	≥ 0.85
Circuit	electromagnetical	electromagnetical
Protection class	I	I
Lamp / Illuminant	HME 125 W, HSE 70 W	HME 250 W, HSE 150 - 250 W, HIE 250 W
Lamp name	high pressure sodium lamp	high pressure sodium lamp, Metal-halide lamp
Rated luminous flux	¹⁾	¹⁾
Lamp cap	E27 accord. IEC 60238	E40 accord. IEC 60238
Light output ratio	76 %	76 %
Dimensions (L x W x H)	480 mm x Ø 245 mm	560 mm x Ø 300 mm
Connecting terminals (Ex-e)	L, N, PE: 2 x 2.5 mm ² PE external 2 x 6 mm ²	L, N, PE: 2 x 2.5 mm ² PE external 2 x 6 mm ²
Enclosure colour	epoxy paint, body RAL 7032 / cover RAL 7016 / ring RAL 6005	epoxy paint, body RAL 7032 / cover RAL 7016 / ring RAL 6005
Enclosure material	light alloy	light alloy
Weight	14.1 kg	22.4 kg
Cable glands / gland plates / enclosure drilling	2 x M25 thread (Ex-e), 1 x plugged	2 x M25 thread (Ex-e), 1 x plugged
Type of mounting	ceiling mounting	ceiling mounting
Degree of protection accd. to EN 60529	IP66	IP66
Protective cover / protective bowl	borosilicate glass	borosilicate glass

¹⁾ see table luminaire data

Additional luminaire data EV.

Lamp	Power	luminous flux ²⁾	Type	Enclosure size		Temperature class II 2 G		max. surface temp. II 2 D	
				small	large	T ₀ ≤ 40 °C	T ₀ ≤ 55 °C	T ₀ ≤ 40 °C	T ₀ ≤ 55 °C
High pressure sodium lamp HSE	70 W	5600 lm	EVS 70 ZM	X		T5	T4	T95°C	T110°C
High pressure sodium lamp HSE	150 W	14000 lm	EVS 150 ZM		X	T5	T4	T90°C	T105°C
High pressure sodium lamp HSE	250 W	25000 lm	EVS 250 ZM		X	T4	T4	T115°C	T130°C
Metal halide lamp HIE	250 W	19000 lm	EVH 250 ZM		X	T4	T3	T125°C	T140°C

²⁾ depends on used lamps

4.4

Technical data

dHLS 85



4 Technical data

dHLS 85

EC-Type Examination Certificate	DMT 03 ATEX E 039
IECEX Certificate of Conformity	IECEX BVS 11.0066
Marking accd. to 2014/34/EU	Ⓜ II 2 G Ex de IIC T3 Gb
Marking accd. to IECEX	Ex de IIC T3 Gb
Permissible ambient temperature	-20 °C up to +50 °C / -20 °C up to +55 °C (250 W) -50 °C up to +50 °C (option)
Rated voltage	230 V AC
Frequency	50 Hz
Power factor cos	0.5 ind. / 0.9 comp. ²⁾
Circuit	inductive circuit / compensated circuit ²⁾
Protection class	I
Lamp / Illuminant	HSE/HME 250 - 400 W
Lamp name	Mercury vapour, high pressure sodium lamp
Rated luminous flux	¹⁾
Lamp cap	E40 accord. IEC 60238
Connecting terminals	L, N, PE max. 2 x 2.5 mm ²
Enclosure material	light alloy with powder coating
Weight	30 kg
Cable glands / gland plates / enclosure drilling	1 x M25 x 1.5 for cables from Ø 8 - 17 mm 1 x M25 x 1.5 with blanking plug
Type of mounting	ceiling mounting
Degree of protection accd. to EN 60529	IP65
Protective cover / protective bowl	borosilicate glass

¹⁾ see table luminaire data

²⁾ with installed ballast enclosure on top

Additional luminaire data dHLS 85

Lamp	Power	luminous flux ²⁾	Type
High pressure sodium lamp HSE	250 W	25000 lm	dHLS 85250
High pressure sodium lamp HSE	400 W	48000 lm	dHLS 85400



Technical data

	EVZ (small enclosure)	EVZ (large enclosure)
EC-Type Examination Certificate	TÜV 12 ATEX 7169X	TÜV 12 ATEX 7169X
IECEX Certificate of Conformity	IECEX CQM 11.0002	IECEX CQM 11.0002
Marking accd. to 2014/34/EU	⊕ II 2 G Ex d e IIC T* Gb ¹⁾ ⊕ II 2 D Ex tD A21 IP66 T* ¹⁾	⊕ II 2 G Ex d e IIC T* Gb ¹⁾ ⊕ II 2 D Ex tD A21 IP66 T* ¹⁾
Marking accd. to IECEx	Ex d e IIC T* Gb ¹⁾ Ex tD A21 IP66 T* ¹⁾	Ex d e IIC T* Gb ¹⁾ Ex tD A21 IP66 T* ¹⁾
Permissible ambient temperature	-40 °C up to +55 °C	-40 °C up to +55 °C
Frequency	50 Hz	50 Hz
Power factor cos φ	≥ 0.9	≥ 0.9
Protection class	I	I
Lamp / Illuminant	HSE 70 - 150 W, HIE 70 - 150 W	HSE 250 - 600 W, HIE 250 - 400 W
Lamp name	High pressure sodium lamp, Metal halide lamp	High pressure sodium lamp, Metal halide lamp
Rated luminous flux	¹⁾	¹⁾
Lamp cap	E27 accord. IEC 60238 (HSE 70 W, HIE. 70 - 150 W) E40 accord. IEC 60238 (HSE 100 - 150 W)	E40 accord. IEC 60238
Dimensions (L x W x H)	Ø 215 mm x 480 mm	Ø 300 mm x 599 mm
Connecting terminals (Ex-e)	3 x 2 x 4 mm ² (L, N, PE) max. 2 Leiter	3 x 2 x 4 mm ² (L, N, PE) max. 2 Leiter
Enclosure colour	grey	grey
Enclosure material	copper free aluminium	copper free aluminium
Weight	14.1 kg	22.4 kg
Cable glands / gland plates / enclosure drilling	2 x M25 thread, 1 x M25 Ex-e screw plug	2 x M25 thread, 1 x M25 Ex-e screw plug
Type of mounting	ceiling mounting	ceiling mounting
Degree of protection accd. to EN 60529	IP66	IP66
Protective cover / protective bowl	toughened glass	toughened glass

¹⁾ see table luminaire data

Additional luminaire data EVZ

Lamp	Power	luminous flux ²⁾	Type	Temperature class II 2 G		max. surface temp. II 2 D	
				T _u ≤ 40 °C	T _u ≤ 55 °C	T _u ≤ 40 °C	T _u ≤ 55 °C
High pressure sodium lamp HSE	70 W	5600 lm	EVZIS*07*	T5	T4	83 °C	98 °C
High pressure sodium lamp HSE	100 W	8800 lm	EVZIS*10*	T5	T4	94 °C	109 °C
High pressure sodium lamp HSE	150 W	14000 lm	EVZIS*15*	T4	T4	113 °C	128 °C
High pressure sodium lamp HSE	250 W	25000 lm	EVZIS*25*	T3	T3	134 °C	149 °C
High pressure sodium lamp HSE	400 W	48000 lm	EVZIS*40*	T3	T3	146 °C	161 °C
High pressure sodium lamp HSE	600 W	90000 lm	EVZIS*60*	T3	T3	167 °C	182 °C
Metal halide lamp HIE	70 W	5100 lm	EVZIM*07*	T5	T4	83 °C	98 °C
Metal halide lamp HIE	100 W	7800 lm	EVZIM*10*	T4	T4	97 °C	112 °C
Metal halide lamp HIE	150 W	11000 lm	EVZIM*15*	T4	T4	111 °C	126 °C
Metal halide lamp HIE	250 W	19000 lm	EVZIM*25*	T3	T3	132 °C	147 °C
Metal halide lamp HIE	400 W	33000 lm	EVZIM*40*	T3	T3	167 °C	182 °C

²⁾ depends on used lamps