

# A softer start, from pumps right up to the complex machines



Powering Business Worldwide

# Eaton – the Right Drive for your Technology.

In the field of plant and machinery construction Eaton is your single-source provider. Whether energy management, automation, signaling or solutions all around the motor – Eaton covers the entire machine. Variable frequency drives, soft starters, motor starters and hydraulics components provide solutions for all tasks involving drives.

### Motor-protective circuit-breaker PKZ

SmartWire-DT turns standard switchgear into intelligent automation devices.

### PKE motor-protective circuit-breakers

Knowing exactly how much power a motor is using at all times has clear benefits: Overload increases machine availability.

### DS7 soft starters

Through SmartWire-DT the PLC has direct access to all of the soft starter's parameters.

### PowerXL™ variable frequency drives

All variable frequency drives of the PowerXL family DC1 and DA1 can be quickly connected to SmartWire-DT.

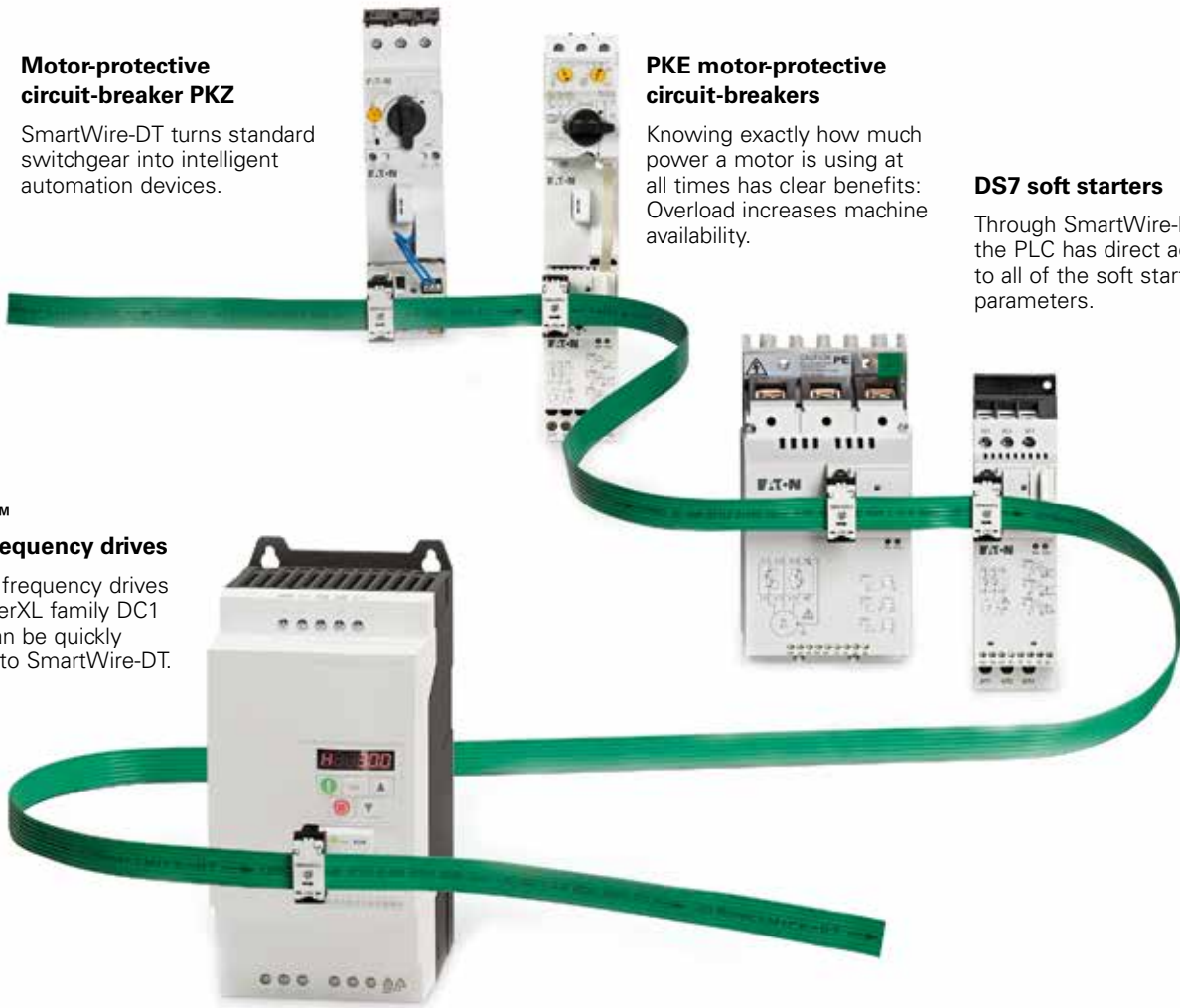

### Reduce costs with SmartWire-DT

Machinery construction needs a technology that simplifies its processes. SmartWire-DT moves the I/O level to the devices, allowing simple, quickly engineered structures without an I/O level at the PLC. Data transparency simplifies diagnostics and maintenance, thereby reducing wiring, testing and commissioning time and costs by up to 85 %.

### Example: Savings at every stage of the lifecycle

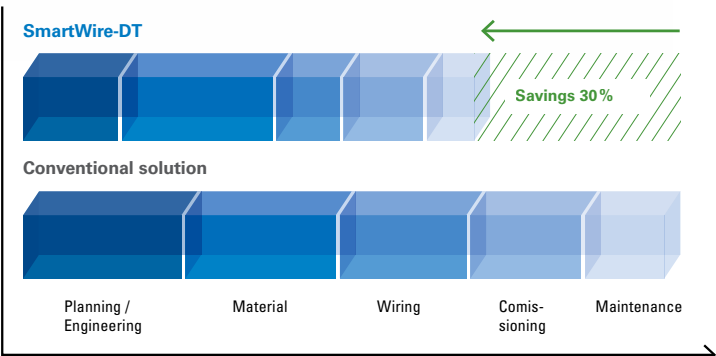



Eaton produces world market products for machinery construction. [www.eaton.eu/softstarter](http://www.eaton.eu/softstarter)



Eaton has a local presence for its customers in more than 175 countries. [www.eaton.eu/electrical/customersupport](http://www.eaton.eu/electrical/customersupport)



For CAD data for our products see on [www.eaton.eu/cad](http://www.eaton.eu/cad)



In the drive technology product range catalog you will find all data at a glance [http://ecat.moeller.net/flip-cat/?edition=DRIVES1\\_EN](http://ecat.moeller.net/flip-cat/?edition=DRIVES1_EN)

### Ahead of the future

Machinery construction is becoming increasingly demanding and competitiveness depends more and more on the technology and on the suppliers's capability to present themselves effectively on the market. Eaton is your right partner to help you achieve these aims. From effective detail solutions

through overall efficiency to our comprehensive service we provide al-inclusive solutions on a national and global level.

### A focus on drives engineering

With its Moeller Series products Eaton has been a reliable partner in machinery engineering for many decades. Product brands such as PKZ, DIL and RMQ-Titan prove the

point. A further focus is on drives engineering, which is continually being expanded with innovative new products. The development focus here is on the efficiency of your processes and solutions.

### SmartWire-DT for drives engineering

Our intelligent connection and communications technology SmartWire-DT is gaining

popularity and is successfully establishing in all segments. The core of the SmartWire-DT strategy is the identification and optimization of the operating sequences in machinery and control panel construction. Our product portfolio – from motor starters through soft starters to variable frequency drives – has continued to expand to the present day.





## Soft starter in the xStart system. Soft at the start, high on torque

The soft starter has become increasingly established as an alternative to the star-delta starter. The soft starter DS7 can handle applications based around a single-phase load of up to 200 A without further add-ons. It combines the benefits of its predecessor, the DS4, with those of the xStart system.

The DS7 is a fully integral element in this system; all existing components can be used. The DS7 replaces the mechanical contactor and extends the function "Motor soft start". Motor start-up is soft but still at a higher torque than other available solutions using a patented method. Extended service intervals and reduced operating costs are welcomed side effects.

Designed for normal applications such as pumps, fans and small conveyors, the compact DS7 is ideal. The DS7 will soon be available with a SmartWire-DT connection to simplify wiring and enhance functionality as an automation solution.





### Application examples

- Single and three-phase inductive loads
- Noiseless and soft switching of motor starters in transport and conveyor belts
- Soft starting of pumps reduces the load on the entire installation (water impact)

- Solid-state switching of pumps in the extreme environments of chemical plants and filling stations
- Smooth start that reduces wear on V-belts in fan drives

### Soft starting: the modern alternative to star-delta starters

Electronic soft starter fulfil the customer demand for an impact free rise in torque and a determined reduction in current during the start phase. You control the power supply of the three-phase motor in the start phase so that the motor matches the load behaviour of the load machine. The mechanical equipment is accelerated with the minimum of stress as a result. The operating behaviour and the work processes are influenced positively which means that negative influences are avoided such as:

- Impacting of cog edges in the gearbox,
- Reduction of the water hammers in pipe systems,
- Slipping of V-belts,
- Jitter with conveyor systems.

The product standard for the area of soft starters is the IEC / EN 60 947-4-2.

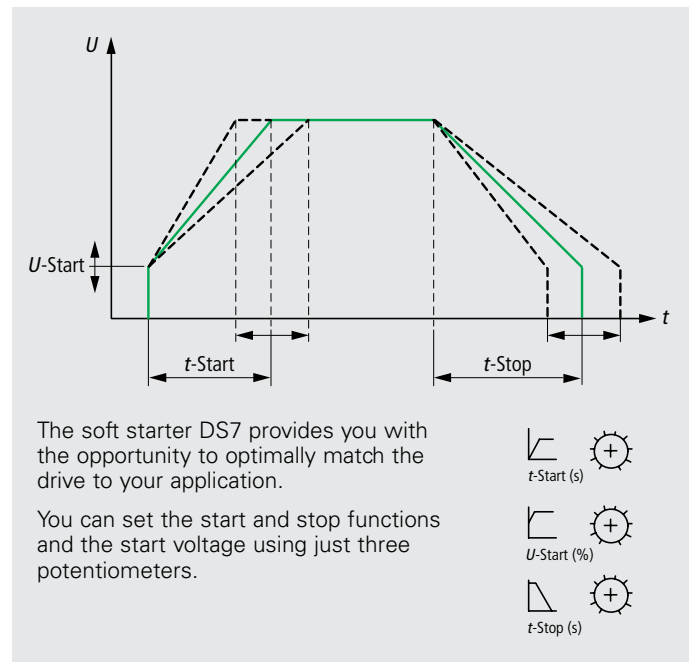

### Asymmetric control: It does not get any softer

The asymmetrical trigger control developed and patented (PCT/EP00/12938, 19.12.2000) by Eaton makes it possible. It avoids DC components which normally result on a two-phase controlled soft starter (see diagram). They suppress the formation of an elliptical rotating field, which leads to an irregular acceleration of the motor and unnecessarily extends acceleration times. On DS7 series devices, an asymmetric trigger control is active during the start and stop ramp.

### Current characteristic in the uncontrolled phase

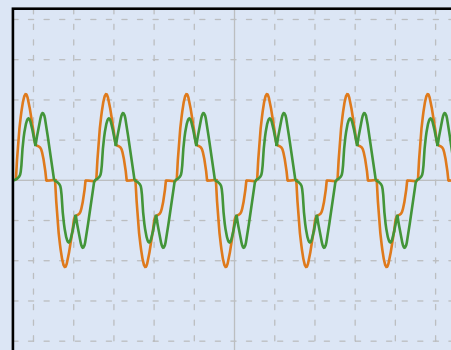

Conventional methods:

Symmetrical control with high level of DC components

New process from Eaton:

Asymmetric control without DC components



### Full integration prevents limitations

The built-in fan removes any limitations when connecting accessories. Even with a built-in fan, the overload relay can be attached directly to the DS7. Accordingly, the handling does not need to be reconsidered irrespective of whether standard

applications or applications requiring additional cooling are necessary, e.g. with increased starting frequency or higher ambient temperatures. The xStart system concept is retained.

## Soft starter DS7 up to 32 A for three-phase power supply

low operating frequency (5 s, 3x le, 10 Starts)



Assigned motor rating at 400 V kW	Assigned motor rating at 460 V HP	Rated operational current <sup>1)</sup> A
1,1	1,5	3
1,5	2	4
2,2	3	5
3	5	7
4	5	9
5,5	10	12
7,5	10	16
11	15	24
15	25	32

#### Softstarter

#### Contactor and motor protection<sup>2)</sup>

#### Overload relay<sup>3)</sup> (optional)

#### Mains contactor<sup>4)</sup> (optional)

			<b>In-Line</b>	<b>Part no.</b>	<b>Part no.</b>	<b>Part no.</b>
			<b>Part no.</b>			
			DS7-34xSX004NO-x	PKZM0-4 (+ CL-PKZ0)	ZB12-4	DILM7
			DS7-34xSX004NO-x	PKZM0-4 (+ CL-PKZ0)	ZB12-4	DILM7
			DS7-34xSX007NO-x	PKZM0-6,3 (+ CL-PKZ0)	ZB12-6	DILM7
			DS7-34xSX007NO-x	PKZM0-10 (+ CL-PKZ0)	ZB12-10	DILM9
			DS7-34x009NO-x	PKZM0-10 (+ CL-PKZ0)	ZB12-10	DILM9
			DS7-34xSX0012NO-x	PKZM0-12 (+ CL-PKZ0)	ZB12-12	DILM12
			DS7-34xSX0016NO-x	PKZM0-16 (+ CL-PKZ0)	ZB32-16	DILM17
			DS7-34xSX0024NO-x	PKZM0-25 (+ CL-PKZ0)	ZB32-24	DILM25
			DS7-34xSX0032NO-x	PKZM0-32 (+ CL-PKZ0)	ZB32-32	DILM32

- Notes:**
- 1) Rated operational current related to the stated load cycle.
  - 2) States the required circuit-breaker for the defined load cycle. With other switching operations (operating frequency, overcurrent, overcurrent time, duty factor) this value changes and must be matched accordingly. The same applies with higher motor currents.
  - 3) An external overload relay is necessary, if the main circuit is not to be disconnected with an overload but rather a controlled soft stop is required
  - 4) A mains contactor is not necessary. Isolating characteristics to VDE can only be assured via the stated circuit-breaker.

## Together they are strong – xStart system

Whether motor connector or PKE connection, the soft starter DS7 integrates seamlessly into this system. Even integration into the automation using a SmartWire-DT connection is possible. Should separate motor protection be required, the overload relays ZB12 or ZB32 can also be mounted together with the optional fan. A system without limitations that can be configured to the requirements of the user.



## Soft starter DS7 in the xStart System (up to 32 A)

### Legend

1. DS7 with SmartWire-DT
2. DS7 size 1 up to 12 A
3. DS7 size 2 up to 32 A
4. Device fan DS7-FAN-32
5. SmartWire-DT gateways
6. SmartWire-DT external device connector
7. SmartWire-DT cable
8. Overload relay
9. Motor connector in tool-less plug connection
10. Socket for motor connector
11. Wiring set PKZM0-XDM in tool-less plug connection
12. Wiring set PKZM0-XDM in tool-less plug connection
13. Wiring set PKZM0-XDM
14. Three-phase commoning link
15. Standard auxiliary contact
16. Early-make auxiliary contact
17. Motor-protective circuit-breaker PKZM0
18. Motor-protective circuit-breaker PKE
19. Incoming terminal
20. Voltage release
21. Standard auxiliary contact
22. Standard auxiliary contact
23. Motor-starter combination with PKZ
24. Motor-starter combination with PKE
25. Busbar adapter
26. Top-hat rail adapter plate
27. Top-hat rail adapter plate

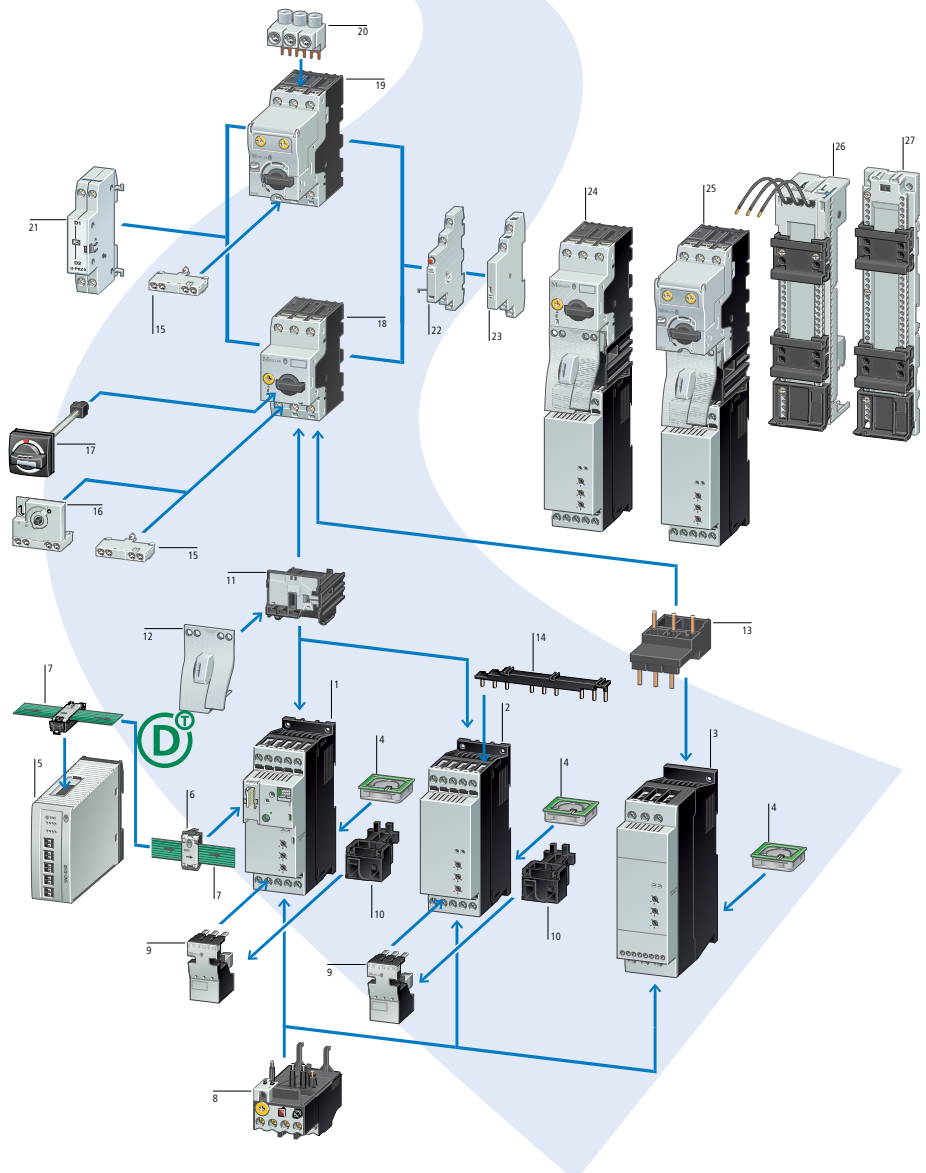

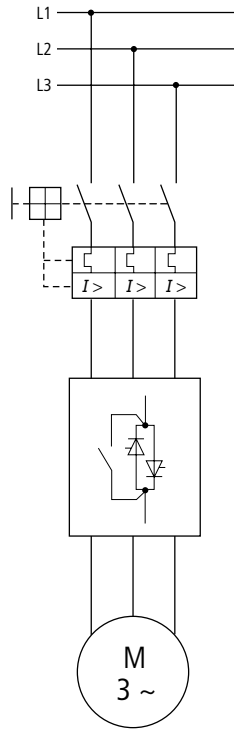

### Compact „in-line“ starter – Soft starter DS7 in a system

The performance spectrum is spread across just two sizes. The dimensions and the terminals correspond with the tried and tested Eaton standard from the circuit-breakers NZM1 (up to 55kW) and NZM2 (up to 110 kW).

In conjunction with the mounting and connection accessories of the circuit-breaker series NZM, the devices of the DS7 series provide the opportunity for compact electronic motor starters up to 200 A.

The terminals on the NZM can be optimally matched to those of the DS7 with the spacers NZM1/2-XAB.

## Soft starter DS7 up to 200 A for three-phase power supply

low operating frequency (5 s, 3x Ie, 10 Starts)



Assigned motor rating at 400 V kW	Assigned motor rating at 460 V HP	Rated operational current <sup>1)</sup> A	Soft starter <b>In-Line</b> Part no.	Contactor and motor protection <sup>2)</sup> Coordination type 1) Part no.	Overload relay <sup>3)</sup> Part no.	Mains contactor optional <sup>4)</sup> Part no.
22	30	41	DS7-34xSX041N0-x	NZMN1-M50 / PKZM4-50	ZB65-40+ZB65-XEZ	DILM50
30	40	55	DS7-34xSX055N0-x	NZMN1-M63 / PKZM4-58	ZB65-57+ZB65-XEZ	DILM65
37	50	70	DS7-34xSX070N0-x	NZMN1-M80	ZB150-70/KK	DILM80
45	60	81	DS7-34xSX081N0-x	NZMN1-M100	ZB150-100/KK	DILM95
55	75	100	DS7-34xSX100N0-x	NZMN1-M100	ZB150-100/KK	DILM115
75	100	135	DS7-34xSX135N0-x	NZMN2-M160	ZB150-150/KK	DILM150
90	125	160	DS7-34xSX160N0-x	NZMN2-M200	Z5-160/FF250	DILM185
110	150	200	DS7-34xSX200N0-x	NZMN2-M200	Z5-220/FF250	DILM225

- Notes:**
- 1) Rated operational current related to the stated load cycle.
  - 2) States the required circuit-breaker for the defined load cycle. With other switching operations (operating frequency, overcurrent, overcurrent time, duty factor) this value changes and must be matched accordingly. The same applies with higher motor currents.
  - 3) An external overload relay is necessary, if the main circuit is not to be disconnected with an overload but rather a controlled soft stop is required
  - 4) A mains contactor is not necessary. Isolating characteristics to VDE can only be assured via the stated circuit-breaker.



# Soft starter DS7 with circuit-breaker NZM (up to 200 A)

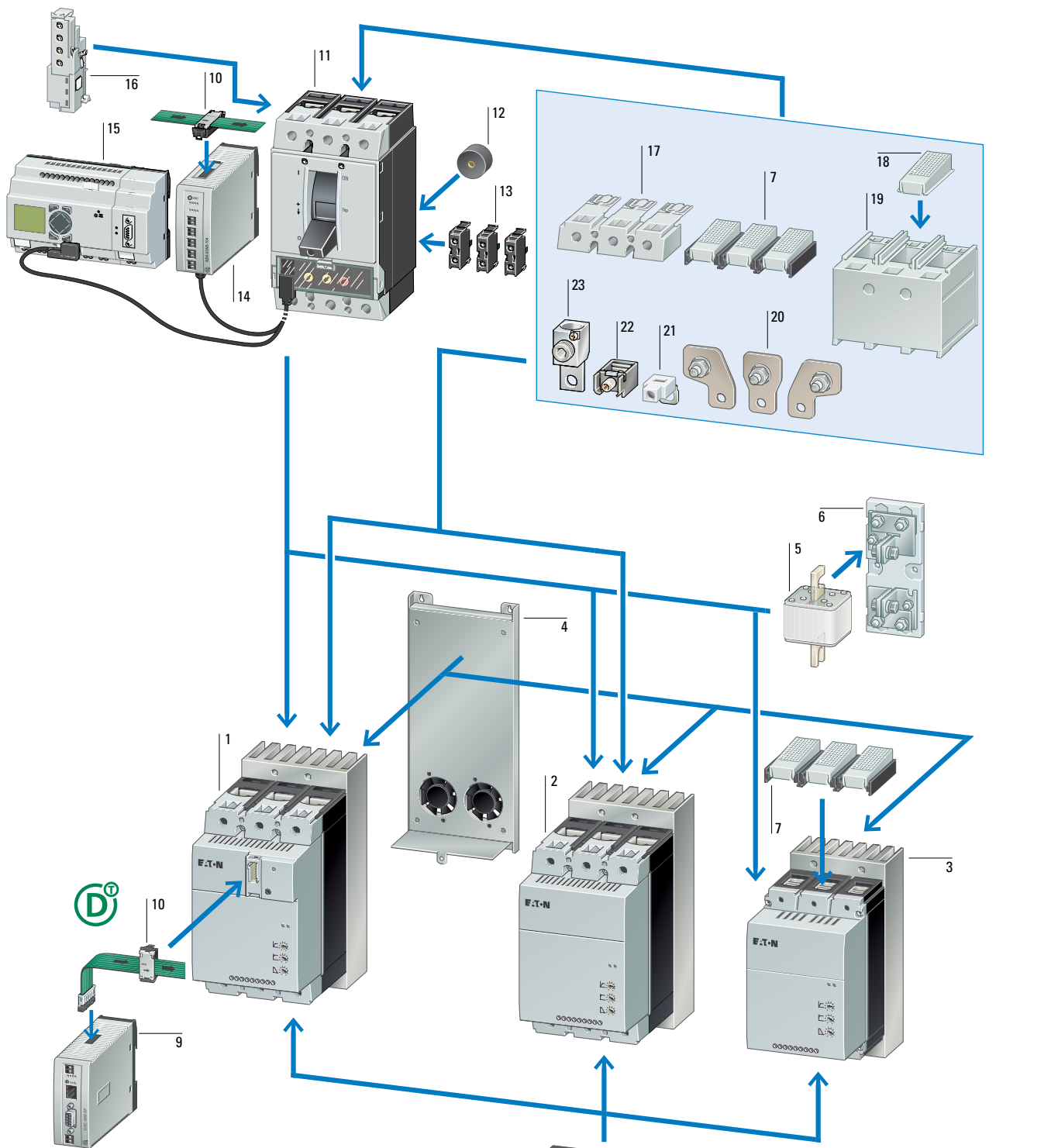

## Legend

- |   |   |   |
|---|---|---|
| 1. DS7 with SmartWire-DT                          | 7. IP2X protection against contact with a finger    | 8. Overload relay                                   |
| 2. DS7 size 4 up to 200 A                         | 8. Overload relay                                   | 9. Gateways for SmartWire-DT                        |
| 3. DS7 size 3 up to 100 A                         | 9. Gateways for SmartWire-DT                        | 10. SmartWire-DT external device connector          |
| 4. Device fan                                     | 10. SmartWire-DT external device connector          | 11. Circuit-breaker NZM                             |
| 5. Superfast semi-conductor fuses                 | 11. Circuit-breaker NZM                             | 12. Spacer  |
| 6. Fuse holder for superfast semi-conductor fuses | 12. Spacer  | 13. Voltage release                                 |
|   | 13. Voltage release                                 | 14. NZM communication module for SmartWire-DT       |
|   | 14. NZM communication module for SmartWire-DT       | 15. Data management Interface (DMI module)          |
|   | 15. Data management Interface (DMI module)          | 16. Voltage releases / Earlymake auxiliary contacts |
|   | 16. Voltage releases / Earlymake auxiliary contacts | 17. Terminal covers for terminals                   |
|   | 17. Terminal covers for terminals                   | 18. IP2X protection against contact with a finger   |
|   | 18. IP2X protection against contact with a finger   | 19. Terminal covers for cable lugs                  |
|   | 19. Terminal covers for cable lugs                  | 20. Connection width extension                      |
|   | 20. Connection width extension                      | 21. Control circuit terminal                        |
|   | 21. Control circuit terminal                        | 22. Box terminals                                   |
|   | 22. Box terminals                                   | 23. Tunnel terminals for and copper cables          |
|   | 23. Tunnel terminals for and copper cables          |   |



## SmartWire-DT – efficient engineering, convenient communication



### DS7 soft starters with SmartWire-DT keep tabs on everything.

SmartWire-DT is an innovative intelligent connection system for your control cabinet. Simply make connections and work without control wiring, without a distributed I/O level, and without having to resort to clunky DIP switch-based address configurations.

In peripheral devices, SmartWire-DT is routed directly to the machine and turns standard switchgear into intelligent and communications-capable automation devices.

SmartWire-DT is the optional add-on and provides all required information without complex and expensive wiring.

### DS7 soft starters with SmartWire-DT – Direct access to all parameters

Being able to use a controller to directly access all of a soft starter's parameters via SmartWire-DT is the epitome of ease of operation. Users can read and overwrite potentiometer settings. Extended status, error, and diagnostic messages can be retrieved directly. The result: absolute data transparency. The plug-in units make installation fast and foolproof, and the resulting connection includes the soft starter's control current supply.

Advantages:

- Reduced I/O level
- Plug-in control wiring prevents wiring errors
- Integrated solution does not require any additional options





Reduced engineering costs, by up to 70%



Fault-free mounting and wiring



Reduced time required for wiring, testing and commissioning by up to 85%

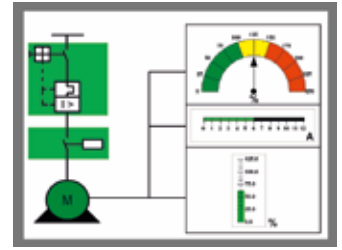

Maintenance with direct diagnostics

### Motor starters from our standard range of products with SmartWire-DT

DS7 soft starters are connected to PKZ or PKE motor-protective circuit-breakers by means of a plug-in design that does not require any tools. NZM circuit-breakers are available for soft starting three-phase asynchronous motors with currents of 32 A and higher.

In conjunction with a PLC, SmartWire-DT is not only a simple and cost-effective solution, but also has many advantages:

- Access to all parameters (read and write)
- Read and overwrite manually configured device parameters
- Detailed diagnostics and status messages available
- Parameter access with a service laptop (parallel to PLC access) even during ongoing operation

### Motor starter combination – Perfect motor protection with PKE

In connection with SmartWire-DT, using a motor-starter combination consisting of a PKE motor-protective circuit-breaker and a DS7 soft starter results in a number of new advantages that provide perfect motor protection and increased availability.

- Device protection against overloads
- Additional soft starter protection if there are too many starts per hour
- Overload protection relay function (in the event of an overload, the DS7 will trip instead of the PKE)
- Diagnostics and status messages available via SmartWire-DT
- Increases system availability by transmitting process-relevant data
- Advance warning function for avoiding overloads
- Eliminates time-consuming troubleshooting during commissioning and maintenance
- Adjustable current limiting function

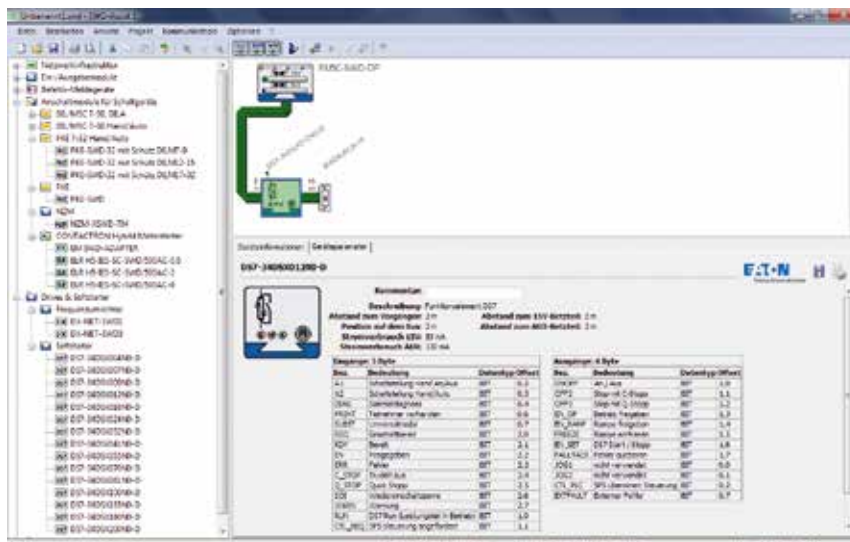

### SWD-Assist helps achieve objectives quickly and simply

SWD-Assist enables users to simply select functional elements from a device catalog and place them where needed. This is of enormous help when planning, designing, and commissioning SmartWire-DT networks, as configurations can be saved and reused in other projects. The software can also test networks and be used to add any missing components.

SWD-Assist can be downloaded for free at:  
<http://applications.eaton.eu/sdlc/?LX=11>



## Soft starter S811+

### Soft to start, powerful range of functionality



The soft starter has become increasingly established as an alternative to the star-delta starter. The DS7 series from Eaton offers solutions for simple applications with up to 200 A of motor current, while the S811+ can handle more complex tasks up to 1450 A.

Three-phase motors are typically for simple and economic implementation of machine and system concepts. Unlike star-delta starters, the soft starter offers a smooth motor start that protects the network. For many applications, it is simply a better solution.

The Eaton S811+ soft starter family is ideal for applications involving pumps, fans and conveyor applications. Extended service intervals and reduced operating costs are welcomed side effects.

The S811+ offer very good performance, including protection functions. The devices are equipped with monitoring functions and are suitable for use in more complex applications. The ease of operation, compact sizes and user-friendly diagnostic functions translate into reduced running costs, despite higher productivity and longer lifespans.



### Application examples

- Three-phase inductive loads
- Soft switching of motor starters in transport and conveyor belts
- Soft starting of pumps reduces the load on the entire installation (water impact)
- Solid-state switching of pumps in the extreme environments of chemical plants and filling stations
- Star-delta replacement (especially for motors over 5.5 kW that must be operated using star-delta starters)
- Fans and pumps for HVAC applications
- Water/water treatment industry
- Mixer
- Crusher
- Underground applications
- Chemical industry
- Extreme ambient conditions (temperature, vibration, aggressive gasses)

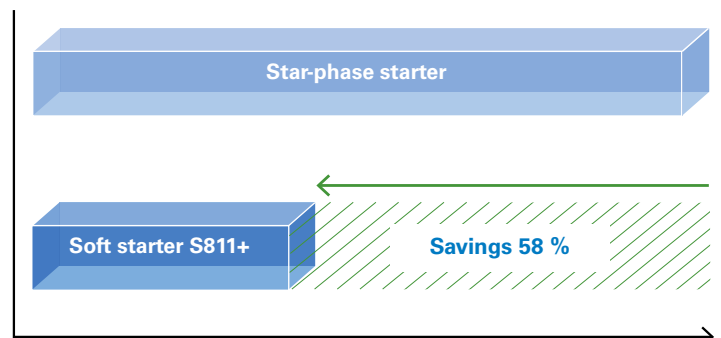

### More power in a minimum of space

When compared with a standard 30 kW star-phase starter, the soft starter S811+ stands out for its minimal size and compactness. As much as 58% less space is required. The soft starter also saves value space in the control cabinet compared with competitors' products.

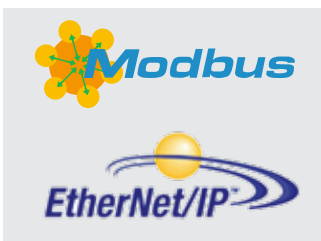

### Simply communicative

The S811+ has an on-board Modbus RTU interface capable of establishing communication without any additional options. All device and monitor data can then be polled within the PLC. A network connector for Ethernet/IP, Modbus TCP, Profibus and DeviceNet (C441x) is also optionally available to make it fully compatible with complex systems.

### On-site diagnostics

The control panel provides clear-text information about the current operating state, regardless of whether it's displaying the three phase currents or offering a diagnostic alarm. As such the user can review the status of the machine without having to reach for the manual.

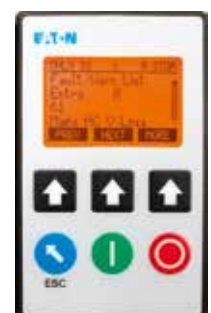

## Water hammer effect, begone

The special pumping algorithm used in the S811+ prevents the infamous water hammer effect when the pump stops. This is above and beyond the normal ramping function in the soft starter, as the algorithm detects the status of the pump and follows its non-linear characteristic curve in a special way to avoid water hammer effect.

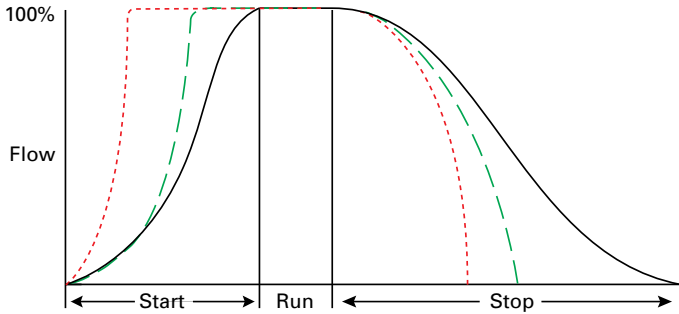

- Direct start by contactor, top load for the mechanics and the pipeline system, water hammer effect „included in the design“
- - - - Conventional soft start, gentle initiation of the pump, soft stop, but always with (reduced) water hammer effect
- Eaton pump stop, with a gentle, steady start even in the final phase and a gentle stop until complete standstill of the pump is achieved, without (or with highly reduced and barely perceptible) water hammer effect, the soft alternative for pump and pipeline systems.

## Tested switchgear combinations for in-line and in-delta connections

Soft starter S811+ offers a flexibly adjustable internal motor protection function. Motor current and overload class can be set up to class 30, eliminating the need for an external overload relay. The measured current can be read out of the internal Modbus interface for further use in the process. The S811+ requires only the NZM circuit-breaker against short circuiting of the motor lines to achieve full motor output. The „In-Delta“ connection is only possible with S811+, as it necessitates an extra mains contactor that is not required for „in-line“ operation.

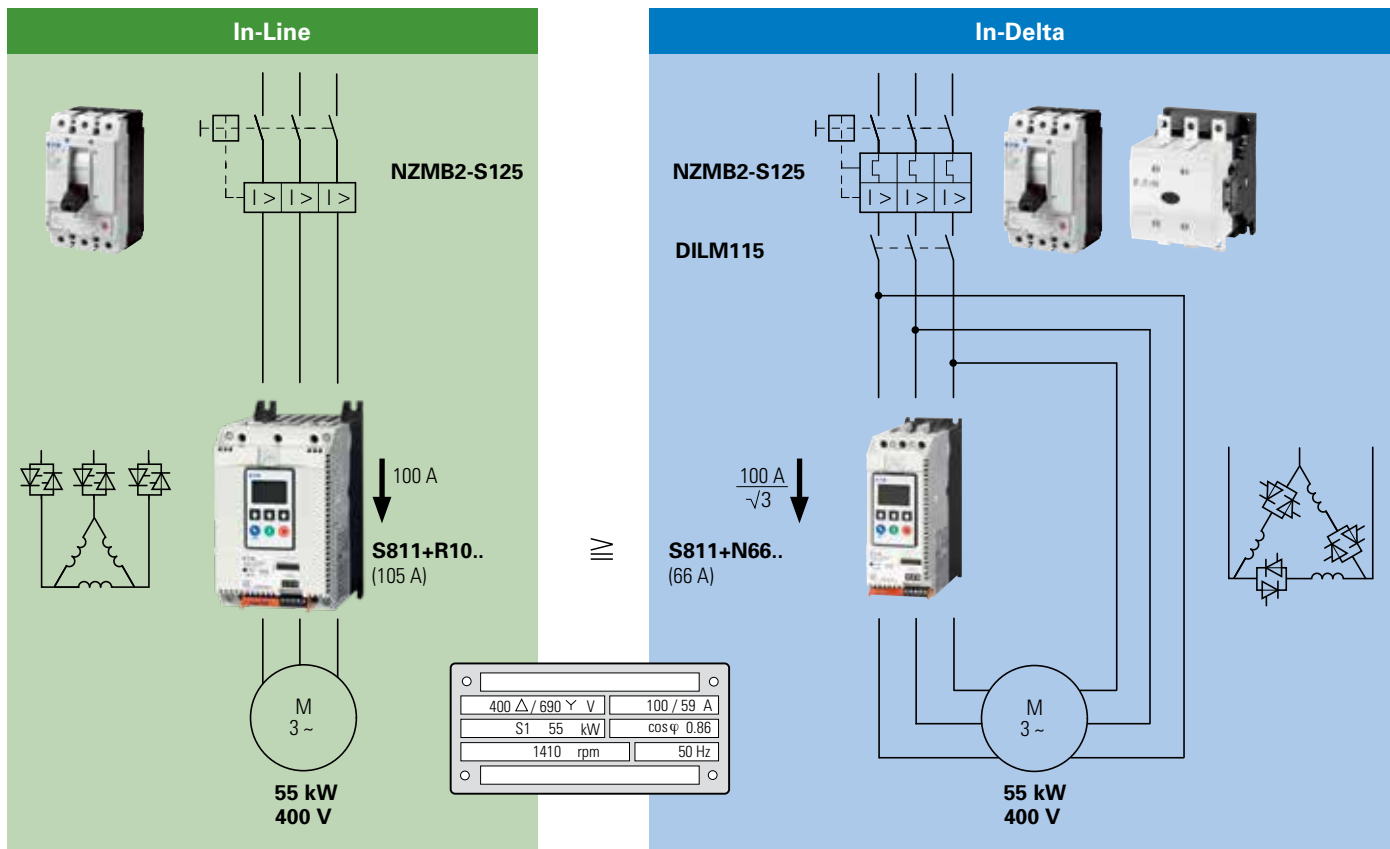

## Soft starter S811+ up to 1471 A



Rated operational current <b>A</b>	assigned motor rating at 400 V <b>kW</b>	assigned motor rating at 480 V <b>HP</b>	Soft starter	Soft starter	Mains contactor	Cable protection
			<b>In-Line</b>	<b>In-Delta</b>		
			Part no.	Part no.	Part no.	Part no.
37	18,5	25	<b>S811+N37P3S</b>			<b>PKM4-40</b>
66	30	50	<b>S811+N66P3S</b>	<b>S811+N37P3S</b>	<b>DILM72</b>	<b>NZMN1-S80</b>
105	55	75	<b>S811+R10P3S</b>	<b>S811+N66P3S</b>	<b>DILM115</b>	<b>NZMN2-S125</b>
135	75	100	<b>S811+R13P3S</b>			<b>NZMN2-S160</b>
180	90	150	<b>S811+T18P3S</b>	<b>S811+R10P3S</b>	<b>DILM185A</b>	<b>NZMN2-S200</b>
240	132	200	<b>S811+T24P3S</b>	<b>S811+R13P3S</b>	<b>DILM250</b>	<b>NZMN3-S250</b>
304	160	250	<b>S811+T30P3S</b>	<b>S811+T18P3S</b>	<b>DILM400</b>	<b>NZMN3-S320</b>
360	200	250	<b>S811+U36P3S</b>	<b>S811+T24P3S</b>	<b>DILM400</b>	<b>NZMN3-S400</b>
360	200	250	<b>S811+V36P3S</b>			<b>NZMN3-S400</b>
420	200	350	<b>S811+U42P3S</b>			<b>NZMN3-S500</b>
420	200	350	<b>S811+V42P3S</b>			<b>NZMN3-S500</b>
500	250	400	<b>S811+V50P3S</b>	<b>S811+T30P3S</b>	<b>DILM580</b>	<b>NZMN3-S500</b>
650	315	500	<b>S811+V65P3S</b>	<b>S811+U36P3S</b>	<b>DILM750</b>	<b>NZMN4-ME875</b>
720	400	600	<b>S811+V72P3S</b>	<b>S811+U42P3S</b>	<b>DILM750</b>	<b>NZMN4-ME875</b>
850	450	600	<b>S811+V85P3S</b>	<b>S811+V50P3S</b>	<b>DILM1000</b>	<b>NZMN4-ME875</b>
1125	630	850		<b>S811+V65P3S</b>	<b>DILM1600</b>	<b>NZMN4-ME1400</b>
1246	630	850		<b>S811+V72P3S</b>	<b>DILM1600</b>	<b>NZMN4-ME1400</b>
1471	750	1100		<b>S811+V85P3S</b>	<b>DILM1600</b>	<b>IZMX16...</b>

(\*) Switch only when at a complete stop

Eaton's mission is to improve the quality of life and the environment through the use of power management technologies and services. We provide sustainable solutions that help our customers effectively manage electrical, hydraulic, and mechanical power – more safely, more efficiently, and more reliably. Eaton's 2019 revenues were \$21.4 billion, and we sell products to customers in more than 175 countries. We have approximately 95,000 employees. For more information, Visit **Eaton.com**

Changes to the products, to the information contained in this document, and to prices are reserved; so are errors and omissions. Only order confirmations and technical documentation by Eaton is binding. Photos and pictures also do not warrant a specific layout or functionality. Their use in whatever form is subject to prior approval by Eaton. The same applies to Trademarks (especially Eaton, Moeller, Cutler-Hammer). The Terms and Conditions of Eaton apply, as referenced on Eaton internet pages and Eaton order confirmations.

**Eaton Industries GmbH**  
Hein-Moeller-Str. 7–11  
D-53115 Bonn/Germany

© 2017 by Eaton Corporation  
All rights reserved  
Publication No.: BR039001EN  
October 2020



*Powering Business Worldwide*

Eaton is a registered trademark of Eaton Corporation

All other trademarks are property of their respective owners.