

9000X AF Drives

User Manual

May 2011
Supersedes June 2009



Disclaimer of Warranties and Limitation of Liability

The information, recommendations, descriptions, and safety notations in this document are based on Eaton Electrical Inc. and/or Eaton Corporation's ("Eaton") experience and judgment, and may not cover all contingencies. If further information is required, an Eaton sales office should be consulted.

Sale of the product shown in this literature is subject to the terms and conditions outlined in appropriate Eaton selling policies or other contractual agreement between Eaton and the purchaser.

THERE ARE NO UNDERSTANDINGS, AGREEMENTS, WARRANTIES, EXPRESSED OR IMPLIED, INCLUDING WARRANTIES OF FITNESS FOR A PARTICULAR PURPOSE OR MERCHANTABILITY, OTHER THAN THOSE SPECIFICALLY SET OUT IN ANY EXISTING CONTRACT BETWEEN THE PARTIES. ANY SUCH CONTRACT STATES THE ENTIRE OBLIGATION OF EATON. THE CONTENTS OF THIS DOCUMENT SHALL NOT BECOME PART OF OR MODIFY ANY CONTRACT BETWEEN THE PARTIES. In no event will Eaton be responsible to the purchaser or user in contract, in tort (including negligence), strict liability or otherwise for any special, indirect, incidental, or consequential damage or loss whatsoever, including but not limited to damage or loss of use of equipment, plant or power system, cost of capital, loss of power, additional expenses in the use of existing power facilities, or claims against the purchaser or user by its customers resulting from the use of the information, recommendations, and descriptions contained herein.

The information contained in this manual is subject to change without notice.

Cover Photo: SVX9000/SPX9000 AF Drives.

Support Services

The goal of Eaton is to ensure your greatest possible satisfaction with the operation of our products. We are dedicated to providing fast, friendly, and accurate assistance. That is why we offer you so many ways to get the support you need. Whether it's by phone, fax, or e-mail, you can access Eaton's support information 24 hours a day, seven days a week. Our wide range of services is listed below.

You should contact your local distributor for product pricing, availability, ordering, expediting, and repairs.

Web Site

Use the Eaton Web site to find product information. You can also find information on local distributors or Eaton's sales offices.

Web Site Address

www.eaton.com/drives

EatonCare Customer Support Center

Call the EatonCare Support Center if you need assistance with placing an order, stock availability or proof of shipment, expediting an existing order, emergency shipments, product price information, returns other than warranty returns, and information on local distributors or sales offices.

Voice: 877-ETN-CARE (877-386-2273) (8:00 a.m.–6:00 p.m. Eastern Time U.S. [UTC –5])

FAX: 800-752-8602

After-Hours Emergency: 800-543-7038

(6:00 p.m.–8:00 a.m. Eastern Time U.S. [UTC –5])

If you are in the U.S. or Canada, and have OI or PLC questions, you can take advantage of our toll-free line for technical assistance with hardware and software product selection, system design and installation, and system debugging and diagnostics. Technical support engineers are available for calls during regular business hours.

Drives Technical Resource Center

Voice: 800-322-4986 or +1 828-651-0984 (8:00 a.m.–5:00 p.m. Central Time U.S. [UTC –6])

Fax: +1 920-262-6070

e-mail: TRCDrives@Eaton.com

For Customers in Europe, Contact:

Eaton Industries GmbH

Electrical Sector

After Sales Service

Hein-Moeller-Str. 7-11

D-53115 Bonn

Phone: +49 (0) 228 6 02-3640

Fax: +49 (0) 228 6 02-61400

Hotline: +49 (0) 180 5 223822

e-mail: AfterSalesEGBonn@Eaton.com

www.moeller.net/aftersales

Table of Contents

SAFETY

Definitions and Symbols	viii
Hazardous High Voltage	viii

OVERVIEW

How to Use This Manual	1
Receiving and Inspection	1
Open SVX9000/SPX9000 Catalog Numbers	2

MOUNTING

Space Requirements	3
Environmental Requirements	4
Standard Mounting Instructions	4

POWER WIRING

Guidelines	5
UL Compatible Cable Selection and Installation	6
UL Compatible Cable Selection and Installation with Breaker	10
Installation Instructions	12
Standard Wiring Diagrams and Terminal Locations	14
Power and Motor Wiring Terminals	17
Checking the Cable and Motor Insulation	20

CONTROL WIRING

General Information	21
Control Wiring Details	23

MENU INFORMATION

Keypad Operation	28
Menu Navigation	30

STARTUP

Safety Precautions	47
Overview	47
Sequence of Operation to Commission an Induction Motor	48
Manual Tuning of the SVX9000/SPX9000	50
Closed Loop Vector Control Manual Tuning (SPX9000 Only)	55

Table of Contents, continued

TECHNICAL DATA

- General **58**
- Specifications **59**
- SVX9000/SPX9000 Series Drives **61**
- Dimensions **64**
- EMC Capability **80**
- Declaration of Conformity **80**
- Warranty and Liability Information **80**

FAULT AND WARNING CODES

- Fault Codes **81**

TROUBLESHOOTING CHARTS USING FAULT CODES

- Using Fault Codes **84**

SPARE PARTS

- Series Option Board Kits **111**
- Johnson Controls Metasys N2 Network Communications **113**
- Drive Options **114**
- Spare Units and Replacement Parts for 9000X Drives **115**

List of Figures

SVX9000/SPX9000 AF Drive Catalog Numbering System	2
Input Power and Motor Cable Stripping and Wire Lengths	12
Wiring Plate.	13
Ground Terminal Locations	13
Cable Protection Plate.	14
Principle Wiring Diagram of SVX9000/SPX9000 Power Unit, FR7 and FR8	15
Principle Wiring Diagram of SVX9000/SPX9000 Power Unit, FR9 to FR10	16
Frame Size: FR4 (230V, 3/4–3 hp and 480V, 1–5 hp).	17
Frame Size: FR5 (230V, 5–7-1/2 hp and 480V, 7-1/2–15 hp)	17
Frame Size: FR6 (230V, 10–15 hp, 480V, 20–30 hp and 575V, 2–25 hp)	18
Frame Size: FR7 (230V, 20–30 hp, 480V, 40–60 hp and 575V, 30–40 hp)	18
Frame Size: FR8 (480V, 75–125 hp and 575V, 50–75 hp)	19
Frame Size: FR9 (480V, 150–200 hp and 575V, 100–175 hp)	19
Option Board Slots	21
Option Board A9 Wiring Diagram	23
Option Board A9 Jumper Location and Settings.	25
Option Board A2 Wiring Diagram	26
Option Board A2 Terminal Locations.	26
Positive Logic	27
Negative Logic	27
Keypad and Display.	28
Main Menu Navigation	31
Parameter Menu Structure Example	32
M2 Keypad Control Menu.	33
Active Fault Display Example	34
Sample Fault History Display	36
System Menu Structure	36
Expander Board Menu Structure	43
Digital Inputs— DIN1, DIN2, DIN3 Status.	44
Digital Inputs— DIN4, DIN5, DIN6 Status.	44
Digital and Relay Outputs— DO1, RO1, RO2 Status	44
Operate Menu Navigation.	45
Open Loop Tuning.	50
Motor Current after V/f Curve Tuning	52
Motor Current Equivalent Circuit	53
OL Speed Control Off OL Speed Control On	54
Closed Loop Motor Voltage	55
Closed Loop Current Limit	57
SVX9000/SPX9000 Block Diagram	58
NEMA Type 1 and Type 12 Enclosure Dimensions.	64
NEMA Type 1 and Type 12 with Flange Kit, FR4, FR5, and FR6 Enclosure Dimensions.	65
NEMA Type 1 with Flange Kit, FR7, and FR8 Enclosure Dimensions.	66
FR9 Enclosure Dimensions.	67
FR9 with Flange Kit Enclosure Dimensions	68
SPX9000, FR10 Open Chassis	69
SPX9000, FR11 Open Chassis	70
SPX9000, FR13 Open Chassis Inverter	71
SPX9000, FR13 Open Chassis Converter	72
SPX9000, FR13 Open Chassis Converter—900/1000 hp 480V	73

List of Figures, continued

AC Choke—CHK0650	74
AC Choke—CHK0520	75
AC Choke—CHK0400	76
AC Choke—CHK0261	77
Control Unit—SPX9000 FR10–FR14	78
Control Unit with Star-Coupler Board, FR12 or FR14 Only	79
F1—Overcurrent	84
F2—Overvoltage	85
F3—Earth Fault	86
F5—Charging Switch	87
F6—Emergency Stop	88
F7—Saturation Trip	89
F8—System Fault	90
F9—Undervoltage	91
F10—Input Line Supervision	92
F11—Output Phase Supervision	93
F12—Brake Chopper Supervision	94
F13—Frequency Converter Under Temperature	95
F14—Frequency Converter Over Temperature	96
F15—Motor Stalled	97
F16—Motor Over Temperature	98
F17—Motor Under Load	99
F22—Param Fault	100
F24—Counter Fault	100
F25—Microprocessor Watchdog Fault	100
F31—IGBT Temperature (Hardware)	101
F32—Fan Cooling	102
F36—Control Unit	103
F37—Device Change	103
F38—Device Added (Indication Only)	103
F39—Device Removed	103
F40—Device Unknown	104
F41—IGBT Temperature	105
F42—Brake Resistor Over Temperature	106
F44—DevParChange	107
F45—DevParAdded	108
F50—Analog Input Iin <4 mA	108
F51—External Fault	109
F52—Keypad Communication Fault	110
9000X Series Option Boards	111
Catalog Number Selection	124

List of Tables

Space Requirements for Mounting an SVX9000/SPX9000 Drive	3
Cooling Airflow Requirements	5
Cable Spacing	5
40°C Cable and Fuse Sizes—230V Ratings	6
40°C Cable and Fuse Sizes—480V Ratings	6
40°C Cable and Fuse Sizes—575V Ratings	7
Cable and Bus Bar Sizes, SPX FR10–FR12—480V Ratings	8
Cable and Bus Bar Sizes, SPX FR13–FR14—480V Ratings	8
Cable and Bus Bar Sizes, SPX FR10–FR12—575V Ratings	9
Cable and Bus Bar Sizes, SPX FR13–FR14—575V Ratings	9
Cable and Breaker Sizes—230V Ratings	10
Cable and Breaker Sizes—480V Ratings	10
Cable and Breaker Sizes—575V Ratings	11
Power Connection Tightening Torque	12
Power and Motor Cable Stripping Lengths	13
Tightening Torques of Terminals	21
Control Wiring Instructions	22
Option Board A9 Terminal Descriptions	24
Option Board A2 Terminal Descriptions	26
LCD Status Indicators	28
Navigation Buttons	29
Fault Types	35
Fault Time Data	35
Total Counters	41
Trip Counters	41
Software Information	41
Application Information	42
Hardware Information	42
Expander Board Information	42
Monitoring Menu Items—Standard Application Example	44
Operate Menu Items—Standard Application Example	45
SVX9000/SPX9000 Drive Specifications	59
208–240V Power Ratings—NEMA Type 1/IP21 or NEMA Type 12/IP54	61
380–500V Power Ratings—NEMA Type 1/IP21 or NEMA Type 12/IP54	62
525–690V Power Ratings—NEMA Type 1/IP21 or NEMA Type 12/IP54	63
Fault Type Categories	81
Fault Codes	81
Option Board Kits	111
Control Panel Factory Options	114
9000X Spare Units	115
Replacement Parts—9000X Drives, 208–240V	115
Replacement Parts—FR4–FR9 9000X Drives, 380–500V	117
Replacement Parts—FR10–FR12 9000X Drives, 380–500V	119
Replacement Parts—FR6–FR9 9000X Drives, 525–690V	121
Replacement Parts—FR10–FR12 9000X Drives, 525–690V	123

Safety

Definitions and Symbols

WARNING

This symbol indicates high voltage. It calls your attention to items or operations that could be dangerous to you and other persons operating this equipment. Read the message and follow the instructions carefully.



This symbol is the “Safety Alert Symbol.” It occurs with either of two signal words: CAUTION or WARNING, as described below.

WARNING

Indicates a potentially hazardous situation which, if not avoided, can result in serious injury or death.

CAUTION

Indicates a potentially hazardous situation which, if not avoided, can result in minor to moderate injury, or serious damage to the product. The situation described in the CAUTION may, if not avoided, lead to serious results. Important safety measures are described in CAUTION (as well as WARNING).

Hazardous High Voltage

WARNING

Motor control equipment and electronic controllers are connected to hazardous line voltages. When servicing drives and electronic controllers, there may be exposed components with housings or protrusions at or above line potential. Extreme care should be taken to protect against shock.

Stand on an insulating pad and make it a habit to use only one hand when checking components. Always work with another person in case an emergency occurs. Disconnect power before checking controllers or performing maintenance. Be sure equipment is properly grounded. Wear safety glasses whenever working on electronic controllers or rotating machinery.

CAUTION

Remove any External Start signals or permissives before resetting the fault to prevent an unintentional restart of the SVX9000/SPX9000, which could result in personal injury or equipment damage.

WARNING

- 1 Before startup, observe the warnings and safety instructions provided throughout this manual. Internal components and circuit boards (except the isolated I/O terminals) are at utility potential when the SVX9000/SPX9000 is connected to the line. This voltage is extremely dangerous and may cause death or severe injury if you come in contact with it.**
- 2 When the SVX9000/SPX9000 is connected to the utility, the motor connections U (T1), V (T2), W (T3) and DC bus/brake resistor connections B-, B+, and R- are live even if the motor is not running.**
- 3 Do not make any connections when the AF drive is connected to the utility line.**
- 4 Do not open the cover of the AF drive immediately after disconnecting power to the unit, because components within the drive remain at a dangerous voltage potential for some time. Wait at least five minutes after the cooling fan has stopped and the keypad or cover indicators are dark before opening the SVX9000/SPX9000 cover.**
- 5 The control I/O terminals are isolated from the utility potential, but relay outputs and other I/Os may have dangerous external voltages connected even if power is disconnected from the SVX9000/SPX9000.**
- 6 Before connecting to the utility, make sure that the cover of the drive is closed.**

Overview

This chapter describes the purpose and contents of this manual, the receiving inspection recommendations, and the SVX9000/SPX9000 catalog numbering system.

How to Use This Manual

The purpose of this manual is to provide you with information necessary to install, set, and customize parameters, startup, troubleshoot and maintain the Eaton SVX9000/SPX9000 AF drives by Eaton's electrical business. To provide for safe installation and operation of the equipment, read the safety guidelines at the beginning of this manual and follow the procedures outlined before connecting power to the SVX9000/SPX9000. Keep this user manual handy and distribute to all users, technicians, and maintenance personnel for reference along with the appropriate application manual.

Receiving and Inspection

This SVX9000/SPX9000 AC drive has met a stringent series of factory quality requirements before shipment. It is possible that packaging or equipment damage may have occurred during shipment. After receiving your SVX9000/SPX9000 drive, please check for the following:

- Check to make sure that the package(s) includes the proper drive, the User Manual, and rubber conduit covers, screws, conduit plate, and ground straps
- Inspect the unit to ensure it was not damaged during shipment
- Make sure that the part number indicated on the nameplate corresponds with the catalog number on your order

If shipping damage has occurred, please contact the carrier involved and file a claim immediately.

If the delivery does not correspond to your order, please contact your Eaton representative.

Note: Do not destroy the packing. The template printed on the protective cardboard can be used for marking the mounting points of the SVX9000/SPX9000 AF drives on the wall or cabinet.

Overview

Open SVX9000/SPX9000 Catalog Numbers

SVX9000/SPX9000 AF Drive Catalog Numbering System

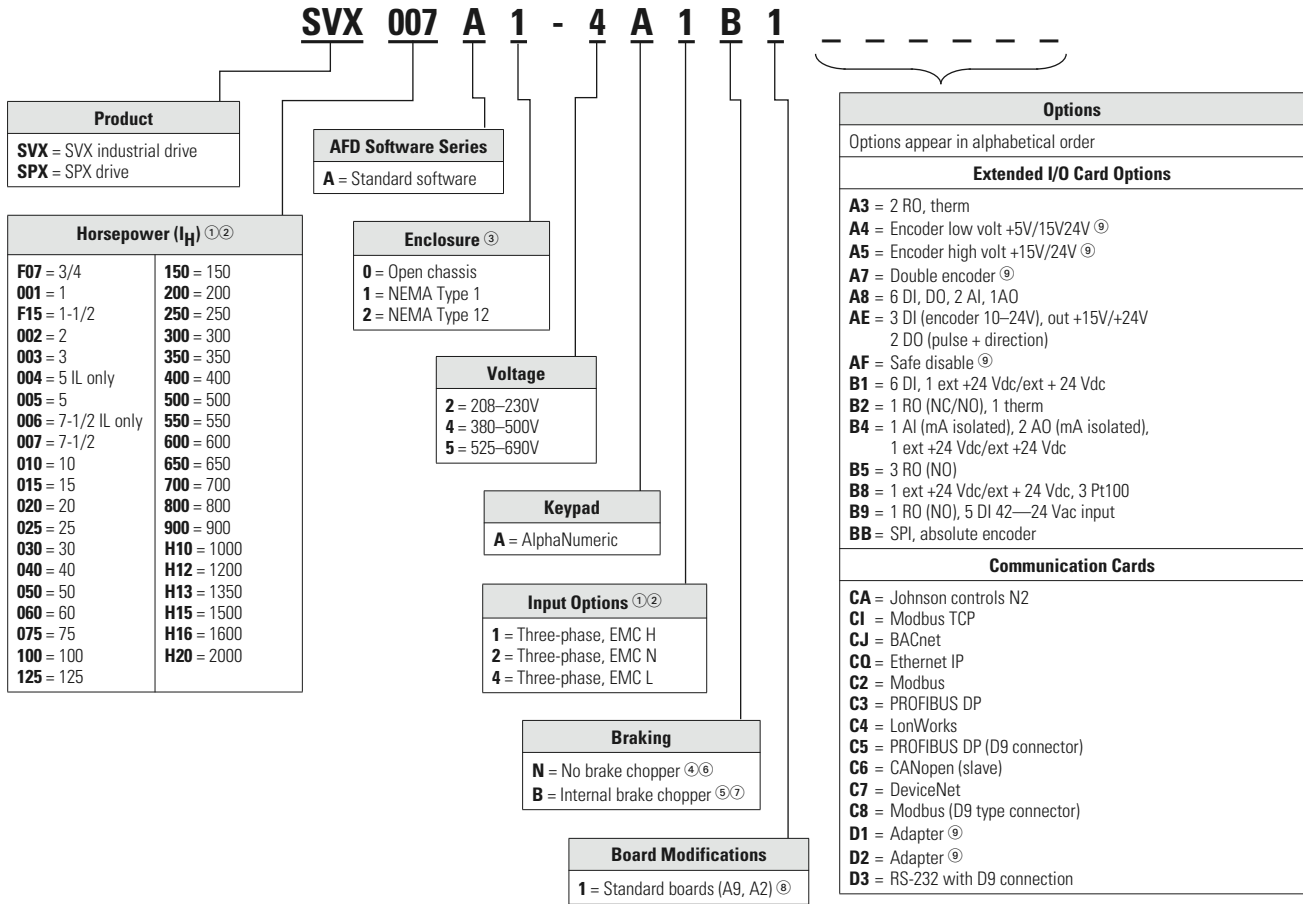

Notes

- ① All 230V drives and 480V drives up to 200 hp (I_H) are only available with input option 1.
- ② 480V drives 250 hp (I_H) or larger are only available with input option 2.
- ③ 480V drives 250 hp, 300 hp and 350 hp (I_H) are only available with enclosure style 0 (chassis).
- ④ 480V drives up to 30 hp (I_H) are only available with brake chopper option B.
- ⑤ 230V drives up to 15 hp (I_H) are only available with brake chopper option B.
- ⑥ 480V drives 40 hp (I_H) and larger come with brake chopper option N as standard.
- ⑦ 230V drives 20 hp (I_H) or larger come with brake chopper option N as standard.
- ⑧ Factory promise delivery. Consult Sales Office for availability.
- ⑨ SPX9000 drives only.

Mounting

The SVX9000/SPX9000 drive may be mounted side-by-side or stacked vertically, as outlined in the following section.

Space Requirements

If several units are mounted above each other, the clearance between the drives should equal C + D (see table and figure on this page). In addition, the outlet air used for cooling the lower unit must be directed away from the inlet air used by the upper unit.

To ensure proper air circulation and cooling, follow the guidelines below.

Space Requirements for Mounting an SVX9000/SPX9000 Drive

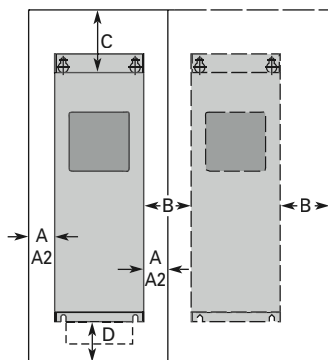

Approximate Dimensions in Inches (mm) ①②

Frame	Drive Type	A ②	A ₂ ③	B ④	C ⑤	D ⑥
4	230V, 1–3 hp I _L , 3/4–3 hp I _H	0.8 (20)	—	0.8 (20)	3.9 (100)	2.0 (50)
	480V, 1–5 hp I _H , 1-1/2–7-1/2 hp I _L					
5	230V, 5–10 hp I _L , 5–7-1/2 hp I _H	1.2 (30)	—	0.8 (20)	4.7 (120)	2.4 (60)
	480V, 7-1/2–15 hp I _H , 10–20 hp I _L					
6	230V, 15–20 hp I _L , 10–15 hp I _H	1.2 (30)	—	0.8 (20)	6.3 (160)	3.1 (80)
	480V, 20–30 hp I _H , 25–40 hp I _L					
	575V, 2–25 hp I _H , 3–30 hp I _L					
7	230V, 25–40 hp I _L , 20–30 hp I _H	3.1 (80)	—	3.1 (80)	11.8 (300)	3.9 (100)
	480V, 40–60 hp I _H , 50–75 hp I _L					
	575V, 30–40 hp I _H , 40–50 hp I _L					
8	480V, 75–125 hp I _H , 100–150 hp I _L	3.1 (80)	5.9 (150)	3.1 (80)	11.8 (300)	7.9 (200)
	575V, 50–75 hp I _H , 60–100 hp I _L					
9	480V, 200–250 hp I _L , 150–200 hp I _H	2.0 (50)	—	3.1 (80)	15.7 (400)	9.8 (250)
	575V, 100–150 hp I _H , 150–200 hp I _L					13.8 (350) ⑦

Notes

- ① Dimensions represent the minimum clearance needed when mounting an SVX9000/SPX9000. See figure above.
- ② A = clearance around the SVX9000/SPX9000.
- ③ A₂ = clearance needed to change the fan without disconnecting the motor cables.
- ④ B = distance between adjacent SVX9000/SPX9000 drives or between the SVX9000/SPX9000 and an enclosure wall.
- ⑤ C = clearance above the SVX9000/SPX9000.
- ⑥ D = clearance below the SVX9000/SPX9000.
- ⑦ Minimum clearance below the SVX9000/SPX9000 needed to change the fan.

Mounting

Environmental Requirements

Ensure that the environment meets the requirements listed in the table on **Pages 59** and **60** for any storage or operating situation.

The table below specifies the minimum airflow required in the area where the drive will be mounted.

Cooling Airflow Requirements

Drive Type	Cooling Air Required
230V, 3/4–3 hp I _H	41 cfm (70 m ³ /h)
480V, 1–5 hp I _H	
230V, 5–7-1/2 hp I _H	112 cfm (190 m ³ /h)
480V, 7-1/2–15 hp I _H	
230V, 10–15 hp I _H	250 cfm (425 m ³ /h)
480V, 20–30 hp I _H	
575V, 2–25 hp I _H	
230V, 20–30 hp I _H	250 cfm (425 m ³ /h)
480V, 40–60 hp I _H	
575V, 30–40 hp I _H	
480V, 75–125 hp I _H	383 cfm (650 m ³ /h)
575V, 60–75 hp I _H	
480V, 150–200 hp I _H	765 cfm (1300 m ³ /h)
575V, 100–150 hp I _H	
480V, 250–350 hp I _H	1530 cfm (2600 m ³ /h)
575V, 200–300 hp I _H	
480V, 400–550 hp I _H	2295 cfm (3900 m ³ /h)
575V, 400–500 hp I _H	
480V, 600–700 hp I _H	3060 cfm (5200 m ³ /h)
575V, 550–700 hp I _H	

Standard Mounting Instructions

1. Measure the mounting space to ensure that it allows for the minimum space surrounding the drive. Drive dimensions are in “Dimensions” starting on **Page 64**.
2. Make sure the mounting surface is flat and strong enough to support the drive, is not flammable, and is not subject to excessive motion or vibration.
3. Ensure that the minimum airflow requirements for your drive are met at the mounting location.
4. Mark the location of the mounting holes on the mounting surface, using the template provided on the cover of the cardboard shipping package.
5. Using fasteners appropriate to your drive and mounting surface, securely attach the drive to the mounting surface using all four screws or bolts.

Power Wiring

Guidelines

To ensure proper wiring, use the following guidelines:

- Use heat-resistant copper cables only, 75°C or higher
- The input line cable and line fuses must be sized in accordance with the rated input current of the unit. See **Pages 6–9**
- Provide a ground wire with both input power and output motor leads

The control should be installed in accordance with all applicable codes. In accordance with NEC 430 Part IV, a protective device is required in the installation of the control. This protective device can be either a fuse or a circuit breaker. An RK fuse is an acceptable component. For maximum protection, Eaton recommends a Class T fuse.

Input line cable and line fuses must be sized in accordance with tables on **Pages 6–9**.

- If the motor temperature sensing is used for overload protection, the output cable size may be selected based on the motor specifications
- If three or more shielded cables are used in parallel for the output on the larger units, every cable must have its own overload protection
- Avoid placing the motor cables in long parallel lines with other cables
- If the motor cables run in parallel with other cables, note the minimum distances between the motor cables and other cables given in the following table

Cable Spacing

Minimum Distance Between Cables in ft (m)	Cable in ft (m)
1 (0.3)	≤164 (50)
3.3 (1.0)	≤656 (200)

Note: The cable spacings also apply between the motor cables and signal cables of other systems.

- The maximum lengths of the motor cables are as follows:
 - 1–2 hp, 230V units, 328 ft (100m)
 - All other hp units, 984 ft (300m)
- The motor cables should cross other cables at an angle of 90 degrees
- If conduit is being used for wiring, use separate conduits for the input power wiring, the output power wiring, the signal wiring, and the control wiring

SVX9000/SPX9000 Drive Short-Circuit Current Rating

The SVX9000/SPX9000 drive has a maximum symmetrical short-circuit current (ISC) rating of 100 kA rms. The ISC ampere rating is in accordance with the requirements of UL 508C “Standard for Power Conversion Equipment”. These requirements cover “open or enclosed equipment that supplies power to control a motor or motors operating at a frequency or voltage different than that of the input supply” including devices rated 1500 volts or less. The SVX9000/SPX9000 drive series uses an electronic overcurrent protection feature for compliance with the UL 508C requirement.

Branch circuit protection must be provided in accordance with local codes.

Power Wiring

UL Compatible Cable Selection and Installation

Use only copper wire with temperature rating of at least 75°C.

40°C Cable and Fuse Sizes—230V Ratings

I _L hp	Frame Size	NEC I (A)	I (A)	Fuse ① Quantity	Fuse (A)	Wire Size	Terminal Size		
						AWG Power	Ground	Power	Ground
1	FR4	4.2	4.8	3	10	14	14	16–12	16–14
1-1/2		6	6.6	3	10	14	14	16–12	16–14
2		6.8	7.8	3	10	14	14	16–12	16–14
3	FR5	9.6	11	3	15	14	14	16–12	16–14
5		15.2	17.5	3	20	12	12	16–8	16–8
7-1/2		22	25	3	30	10	10	16–8	16–8
10	FR6	28	31	3	40	8	8	16–8	16–8
15		42	48	3	60	4	8	14–1/0	10–2
20		54	61	3	80	2	6	14–1/0	10–2
25	FR7	68	72	3	100	2	6	14–1/0	10–2/0
30		80	87	3	110	1	6	14–1/0	10–2/0
40		104	114	3	125	1/0	4	14–1/0	10–2/0
50	FR8	130	140	3	175	3/0	2	4–3/0	4–3/0
60		154	170	3	200	4/0	1/0	3/0–350 kcmil	4–3/0
75		192	205	3	250	300	2/0	3/0–350 kcmil	4–3/0
100	FR9	248	261	3	300	2 x 4/0	3/0	2 x 3/0–350 kcmil	4–3/0

40°C Cable and Fuse Sizes—480V Ratings

I _L hp	Frame Size	NEC I (A)	I (A)	Fuse ① Quantity	Fuse (A)	Wire Size	Terminal Size		
						AWG Power	Ground	Power	Ground
1-1/2	FR4	3	3.3	3	10	14	14	16–12	16–14
2		3.4	4.3	3	10	14	14	16–12	16–14
3		4.8	5.6	3	10	14	14	16–12	16–14
5	FR5	7.6	7.6	3	10	14	14	16–12	16–14
7-1/2		11	12	3	15	12	14	16–12	16–14
10		14	16	3	20	10	12	16–8	16–8
15	FR6	21	23	3	30	10	10	16–8	16–8
20		27	31	3	35	8	8	16–8	16–8
25		34	38	3	50	6	8	14–1/0	10–2
30	FR7	40	46	3	60	4	8	14–1/0	10–2
40		52	61	3	80	2	6	14–1/0	10–2
50		65	72	3	100	2	6	14–1/0	10–2/0
60	FR8	77	87	3	110	1	6	14–1/0	10–2/0
75		96	105	3	125	1/0	4	14–1/0	10–2/0
100		124	140	3	175	3/0	2	4–3/0	4–3/0
125	FR9	156	170	3	200	4/0	1/0	3/0–350 kcmil	4–3/0
150		180	205	3	250	300	2/0	3/0–350 kcmil	4–3/0

Note

① UL recognized type JJS is preferred but RK is acceptable.

40°C Cable and Fuse Sizes—480V Ratings, continued

I _L hp	Frame Size	NEC I (A)	I (A)	Fuse ① Quantity	Fuse (A)	Wire Size	Terminal Size		
						AWG Power	Ground	Power	Ground
200	FR9	240	261	3	350	2 x 4/0	3/0	2 x 3/0–350 kcmil	4–000
250		302	300	3	400	2 x 250	300	2 x 3/0–350 kcmil	4–000
300	FR10	361	385	3	450	2 x 250	300	600 kcmil	300 kcmil
350		414	460	3	500	2 x 300	300	600 kcmil	300 kcmil
400		477	520	3	600	2 x 400	350	600 kcmil	300 kcmil
500	FR11	590	590	6	350	2 x 500	500	Bus bar	Bus bar
550		NS	650	6	400	4 x 4/0	500	Bus bar	Bus bar
600		NS	730	6	450	4 x 250	600	Bus bar	Bus bar
650	FR12	NS	820	6	500	4 x 300	600	Bus bar	Bus bar
700		NS	920	6	500	4 x 300	600	Bus bar	Bus bar
800		NS	1030	6	600	4 x 350	—	Bus bar	Bus bar

40°C Cable and Fuse Sizes—575V Ratings

I _L hp	Frame Size	NEC I (A)	I (A)	Fuse ① Quantity	Fuse (A)	Wire Size	Terminal Size		
						AWG Power	Ground	Power	Ground
3	FR6	3.9	4.5	3	10	14	14	14–1/0	14–2
5		6.1	7.5	3	10	14	14	14–1/0	14–2
7-1/2		9	10	3	15	12	14	14–1/0	14–2
10		11	13.5	3	20	12	12	14–1/0	14–2
15		17	18	3	30	10	10	14–1/0	14–2
20		22	22	3	35	8	8	14–1/0	14–2
25		27	27	3	40	8	8	14–1/0	14–2
30	FR7	32	34	3	45	6	8	14–1/0	14–2
40		41	41	3	50	6	8	14–1/0	10–1/0
50		52	52	3	70	4	6	14–1/0	10–1/0
60	FR8	62	62	3	80	2	6	4–3/0	4–3/0
75		77	80	3	125	1/0	6	4–3/0	4–3/0
100		99	100	3	150	2/0	6	4–3/0	4–3/0
125	FR9	125	125	3	175	3/0	6	4–3/0	4–3/0
150		144	144	3	250	300	1/0	3/0–350 kcmil	4–3/0
200		192	208	3	275	350	2/0	3/0–350 kcmil	4–3/0
250	FR10	242	261	3	350	2 x 4/0	3/0	600 kcmil	300 kcmil
300		289	325	3	400	2 x 250	300	600 kcmil	300 kcmil
400		382	385	3	450	2 x 300	300	600 kcmil	300 kcmil
450	FR11	412	460	6	250	2 x 300	300	Bus Bar	Bus bar
500		472	502	6	300	2 x 350	350	Bus Bar	Bus bar
550		NS	590	6	350	2 x 500	500	Bus Bar	Bus bar
600	FR12	NS	650	6	400	4 x 4/0	500	Bus Bar	Bus bar
700		NS	750	6	450	4 x 250	600	Bus Bar	Bus bar
800		NS	820	6	500	4 x 300	600	Bus Bar	Bus bar

Note

① UL recognized type JJS is preferred but RK is acceptable.

Power Wiring

Cable and Bus Bar Sizes, SPX FR10–FR12—480V Ratings

I _H hp	Frame Size	Current	Internal Power Cables ①	External Power Bus Bars	Qty.
			Cu (per Phase)	Cu (in Inches)	
250	FR10	300	2 x 2/0	1.18 x 0.25	3
300		385	2 x 3/0	1.57 x 0.25	3
350		460	2 x 3/0	1.57 x 0.25	3
400	FR11	520	2 x 2 x 2/0	1.18 x 0.25	6
500		590	2 x 2 x 2/0	1.18 x 0.25	6
—		650	2 x 2 x 2/0	1.18 x 0.25	6
600	FR12	750	2 x 2 x 3/0	1.57 x 0.25	6
—		820	2 x 2 x 3/0	1.57 x 0.25	6
700		920	2 x 2 x 3/0	1.57 x 0.25	6

Cable and Bus Bar Sizes, SPX FR13–FR14—480V Ratings

I _H hp	Frame Size	Current	Internal Power Connections		Supply Bus Bars		
			Bus Bar Size NFE–INU (in Inches)	Bus Bar Size/Phase ② (Choke—NFE) (in Inches)	Cable Size/Phase (Choke—NFE)	Cu (in Inches)	Qty.
800	FR13	1030	2.36 x 0.39	1.57 x 0.25	2 x 300 kcmil	1.57 x 0.25	6
900		1150	3.15 x 0.39	1.57 x 0.25	2 x 250 kcmil	1.57 x 0.25	12
1000		1300	3.15 x 0.39	1.57 x 0.25	2 x 250 kcmil	1.57 x 0.25	12
1200	FR14	1600	2.36 x 0.39	1.57 x 0.25	2 x 250 kcmil	1.57 x 0.25	12
1600		1940	2.36 x 0.39	1.57 x 0.25	2 x 300 kcmil	1.57 x 0.25	12

Notes

- ① 90°C rating recommended.
- ② Rigid copper connection.

Cable and Bus Bar Sizes, SPX FR10–FR12—575V Ratings

I _H hp	Frame Size	Current	Internal Power Cables ①	External Power Bus Bars	Qty.
			Cu (per Phase)	Cu (in Inches)	
200	FR10	208	2 x 2/0	1.18 x 0.25	3
250		261	2 x 2/0	1.18 x 0.25	3
300		325	2 x 2/0	1.18 x 0.25	3
400	FR11	385	2 x 3/0	1.57 x 0.25	3
450		460	2 x 3/0	1.57 x 0.25	3
500		502	2 x 2 x 2/0	1.18 x 0.25	6
—	FR12	590	2 x 2 x 2/0	1.18 x 0.25	6
600		650	2 x 2 x 2/0	1.18 x 0.25	6
700		750	2 x 2 x 2/0	1.18 x 0.25	6

Cable and Bus Bar Sizes, SPX FR13–FR14—575V Ratings

I _H hp	Frame Size	Current	Internal Power Connections		Supply Bus Bars		
			Bus Bar Size NFE–INU (in Inches)	Bus Bar Size/ Phase ② (Choke—NFE) (in Inches)	Cable Size/ Phase (Choke—NFE)	Cu (in Inches)	Qty.
800	FR13	820	2.36 x 0.39	1.57 x 0.25	2 x 300 kcmil	1.18 x 0.25	6
900		920	2.36 x 0.39	1.57 x 0.25	2 x 250 kcmil	1.18 x 0.25	6
1000		1030	2.36 x 0.39	1.57 x 0.25	2 x 300 kcmil	1.18 x 0.25	6
1350	FR14	1300	3.15 x 0.39	1.57 x 0.25	2 x 250 kcmil	1.18 x 0.25	12
1500		1500	2.36 x 0.39	1.57 x 0.25	2 x 250 kcmil	1.18 x 0.25	12
2000		1900	2.36 x 0.39	1.57 x 0.25	2 x 300 kcmil	1.18 x 0.25	12

Notes

① 90°C rating recommended.

② Rigid copper connection.

UL Compatible Cable Selection and Installation with Breaker

Use only copper wire with temperature rating of at least 75°C.

Cable and Breaker ① Sizes—230V Ratings

I _H hp	Frame Size	FLA	Breaker Current	Wire Size ②		Terminal Size	
				AWG Power	Ground	Power	Ground
1	FR4	4.8	15	14	14	12–16	14–16
1-1/2		6.6	15	14	14	12–16	14–16
2		7.8	15	14	14	12–16	14–16
3	FR5	11	15	12	12	12–16	14–16
5		17.5	20	10	10	8–16	8–16
7-1/2		25	30	8	8	8–16	8–16
10	FR6	31	40	8	8	1/0–14	2–14
15		48	60	4	6	1/0–14	2–14
20	FR7	61	80	2	6	1/0–14	2/0–10
25		72	100	2	6	1/0–14	2/0–10
30		87	100	1/0	4	1/0–14	2/0–10

Cable and Breaker ① Sizes—480V Ratings

I _H hp	Frame Size	FLA	Breaker Current	Wire Size ②		Terminal Size	
				AWG Power	Ground	Power	Ground
1-1/2	FR4	3.3	15	14	14	12–16	14–16
2		4.3	15	14	14	12–16	14–16
3		5.6	15	14	14	12–16	14–16
5		7.6	15	14	14	12–16	14–16
7-1/2	FR5	12	20	12	12	8–16	8–16
10		16	30	10	10	8–16	8–16
15		23	30	8	8	8–16	8–16
20	FR6	31	40	8	8	1/0–14	2–14
25		38	50	6	8	1/0–14	2–14
30		46	60	4	6	1/0–14	2–14
40	FR7	61	80	2	6	1/0–14	2/0–10
50		72	100	2	6	1/0–14	2/0–10
60		87	100	1/0	4	1/0–14	2/0–10
75	FR8	105	125	2/0	2	3/0–4	3/0–4
100		140	150	4/0	1/0	350 kcmil–3/0	3/0–4
125		170	200	300	2/0	350 kcmil–3/0	3/0–4
150	FR9	205	250	350	3/0	350 kcmil–2 x 3/0	3/0–4
200		261	300	2 x 250	3/0	350 kcmil–2 x 3/0	3/0–4
250		FR10	300	400	2 x 250	300 kcmil	600 kcmil
300	385		500	2 x 300	300 kcmil	600 kcmil	600 kcmil
350	460		600	2 x 400	300 kcmil	600 kcmil	600 kcmil

Notes

① A UL listed breaker must be used.

② Based on a maximum environment of 104°F (40°C).

Cable and Breaker ① Sizes—480V Ratings, continued

I _H hp	Frame Size	FLA	Breaker Current	Wire Size ②		Terminal Size	
				AWG Power	Ground	Power	Ground
400	FR11	520	700	2 x 500	500	Bus bar	Bus bar
500		590	800	4 x 4/0	500	Bus bar	Bus bar
550		650	900	4 x 250	600	Bus bar	Bus bar
600	FR12	750	1000	4 x 300	600	Bus bar	Bus bar
650		820	1000	4 x 300	600	Bus bar	Bus bar
700		920	1200	4 x 400	—	Bus bar	Bus bar

Cable and Breaker ① Sizes—575V Ratings

I _H hp	Frame Size	FLA	Breaker Current	Wire Size ②		Terminal Size	
				AWG Power	Ground	Power	Ground
2	FR6	3.3	15	14	14	1/0–14	2–14
3		4.5	15	14	14	1/0–14	2–14
5		7.5	15	14	14	1/0–14	2–14
7-1/2		10	20	12	14	1/0–14	2–14
10		13.5	30	10	12	1/0–14	2–14
15		18	30	10	10	1/0–14	2–14
20		22	40	8	8	1/0–14	2–14
25		27	40	8	8	1/0–14	2–14
30	FR7	34	50	6	8	1/0–14	1/0–10
40		41	60	4	6	1/0–14	1/0–10
50	FR8	52	100	2	6	3/0–4	3/0–4
60		62	100	1	6	3/0–4	3/0–4
75		80	125	1/0	6	3/0–4	3/0–4
100		100	150	3/0	6	3/0–4	3/0–4
125	FR9	125	200	4/0	2	350 kcmil–2x3/0	3/0–4
150		144	250	350	1/0	350 kcmil–2x3/0	3/0–4
200	FR10	208	300	2 x 250	300 kcmil	600 kcmil	600 kcmil
250		261	400	2 x 300	300 kcmil	600 kcmil	600 kcmil
300		325	500	2 x 350	300 kcmil	600 kcmil	600 kcmil
400	FR11	385	500	2 x 300	300	Bus bar	Bus bar
450		460	600	2 x 350	350	Bus bar	Bus bar
500		502	700	2 x 500	500	Bus bar	Bus bar
550	FR12	590	800	4 x 4/0	500	Bus bar	Bus bar
600		650	900	4 x 250	600	Bus bar	Bus bar
700		750	1000	4 x 300	600	Bus bar	Bus bar

Notes

The current interrupting of the breaker, up to 100 kAIC, will determine the overall current rating of the combination.

① A UL listed breaker must be used.

② Based on a maximum environment of 104°F (40°C).

Power Wiring

Power Connection Tightening Torque

Rating	Frame Size	Tightening Torque (in-lbs)	Tightening Torque (Nm)
230V, 3/4–3 hp	FR4	5	0.6
480V, 1–5 hp		5	0.6
230V, 5–7-1/2 hp	FR5	13	1.5
480V, 7-1/2–15 hp		13	1.5
230V, 10–15 hp	FR6	35	4
480V, 20–30 hp		35	4
575V, 2–25 hp		35	4
230V, 20–30 hp	FR7	85	10
480V, 40–60 hp		85	10
575V, 30–40 hp		85	10
480V, 75–125 hp	FR8	340/187 ①	40/22 ①
575V, 50–75 hp		340/187 ①	40/22 ①
480V, 150–200 hp	FR9	340/187 ①	40/22 ①
575V, 100–175 hp		340/187 ①	40/22 ①

Installation Instructions

- Strip the motor and input power cables as shown in the figure below and the table on **Page 13**.

Input Power and Motor Cable Stripping and Wire Lengths

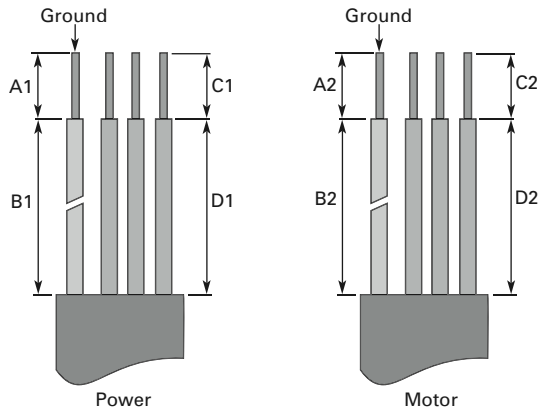

Note

- ① The isolation standoff of the bus bar will not withstand the listed tightening torque. Use a wrench to apply a counter torque when tightening.

Cable Stripping Lengths for Power and Motor Cables

Power and Motor Cable Stripping Lengths

Product hp	Voltage	Frame Size	Power Wiring in Inches (mm)				Motor Wiring in Inches (mm)			
			A1	B1	C1	D1	A2	B2	C2	D2
3/4–3	230V	FR4	0.59 (15)	1.38 (35)	0.39 (10)	0.79 (20)	0.28 (7)	1.97 (50)	0.28 (7)	1.38 (35)
1–5	480V									
5–7-1/2	230V	FR5	0.79 (20)	1.57 (40)	0.39 (10)	1.18 (30)	0.79 (20)	2.36 (60)	0.39 (10)	1.57 (40)
7-1/2–15	480V									
10–15	230V	FR6	0.79 (20)	3.54 (90)	0.59 (15)	2.36 (60)	0.79 (20)	3.54 (90)	0.59 (15)	2.36 (60)
20–30	480V									
2–25	575V									
20–30	230V	FR7	0.98 (25)	4.72 (120)	0.98 (25)	4.72 (120)	0.98 (25)	4.72 (120)	0.98 (25)	4.72 (120)
40–60	480V									
30–40	575V									
75–125	480V	FR8	1.10 (28)	9.45 (240)	1.10 (28)	9.45 (240)	1.10 (28)	9.45 (240)	1.10 (28)	9.45 (240)
50–75	575V									
150–200	480V	FR9	1.10 (28)	11.61 (295)	1.10 (28)	11.61 (295)	1.10 (28)	11.61 (295)	1.10 (28)	11.61 (295)
100–300	575V									

- Locate the plastic bag containing the wiring plate.

Wiring Plate

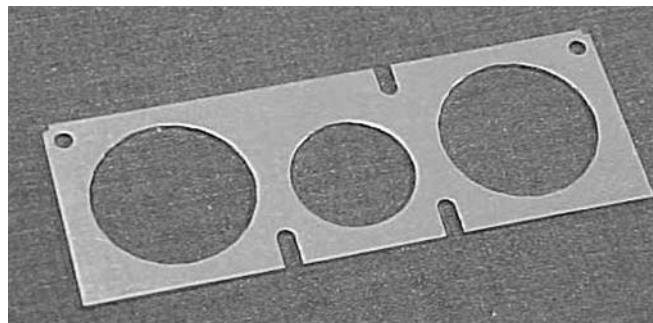

- If conduit is being used, attach the wiring plate to the drive then conduit.
- Pass the motor and input power wires/cables through the holes of the wiring plate.
- Connect the input power and motor and control wires to their respective terminals according to the wiring diagrams in the section marked "Standard Wiring Diagrams and Terminal Locations" on **Page 14**.
- If an optional external brake resistor is used, connect its cable to the appropriate terminals. See "Standard Wiring Diagrams and Terminal Locations" on **Page 14**.
- If shielded cable is used, connect the shields of the input line power cable and the motor cable to the ground terminals of the SVX9000/SPX9000 drive, the motor, and the line power supply.

Ground Terminal Locations

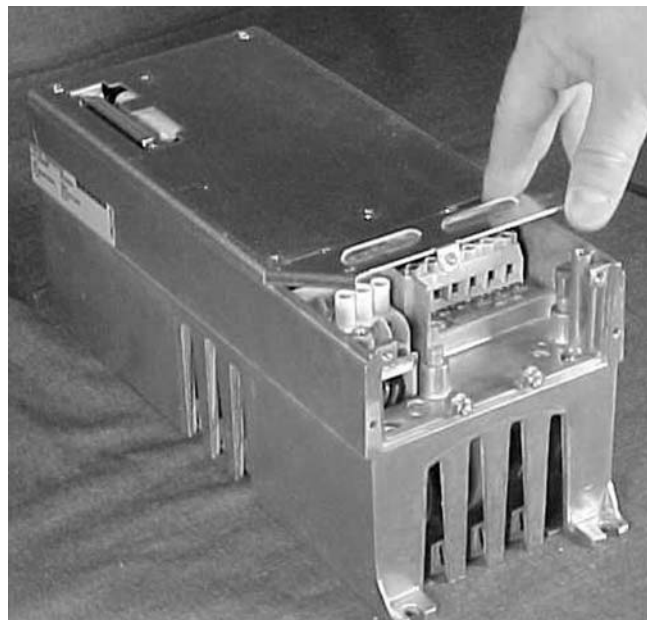

- If shielded cable is not used, check the connection of the ground cable to the motor, the SVX9000/SPX9000 drive, and the input line power terminals marked with .

Power Wiring

9. Attach the wiring plate with the screws provided. Ensure that no wires are trapped between the frame and the wiring plate.
10. Insert the rubber grommets supplied into the wiring plate holes that have not been used, as illustrated in the figure to the right.

Cable Protection Plate

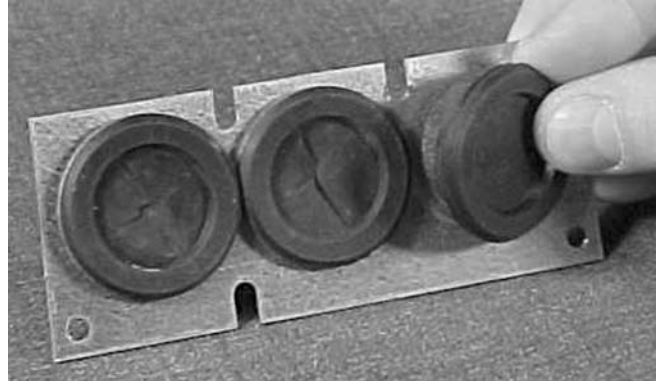

Standard Wiring Diagrams and Terminal Locations

The following wiring diagrams show the line and motor connections of the frequency converter.

Principle Wiring Diagram of SVX9000/SPX9000 Power Unit, FR4 to FR5 and FR6

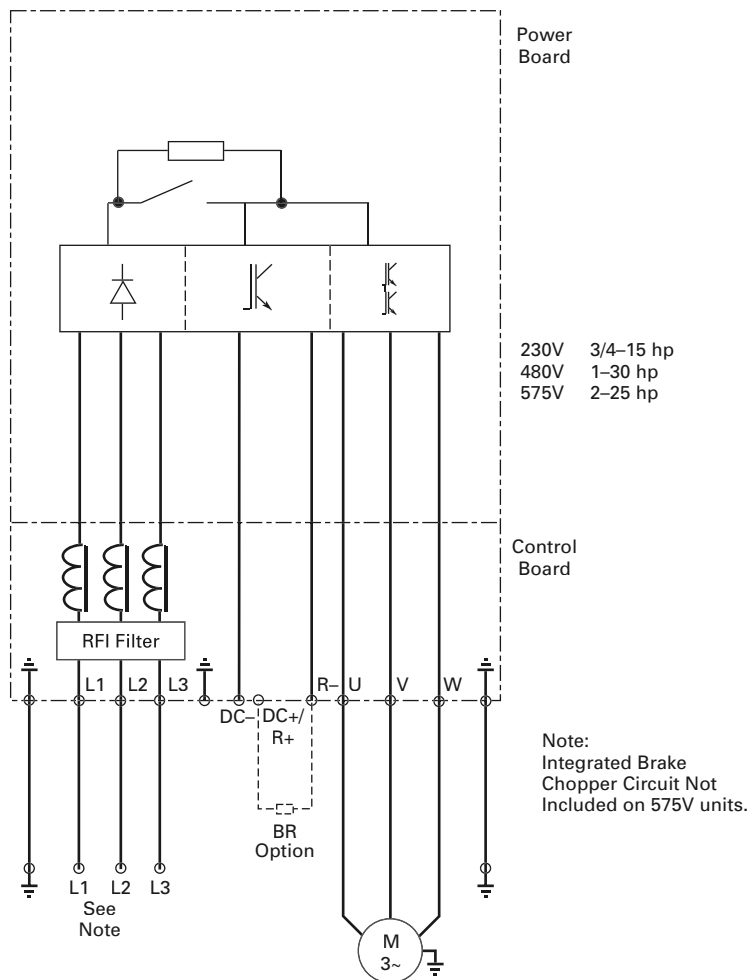

Note: When using a single-phase supply, for units rated for such, connect the input power to terminals L1 and L2. Consult Eaton for more information.

Principle Wiring Diagram of SVX9000/SPX9000 Power Unit, FR7 and FR8

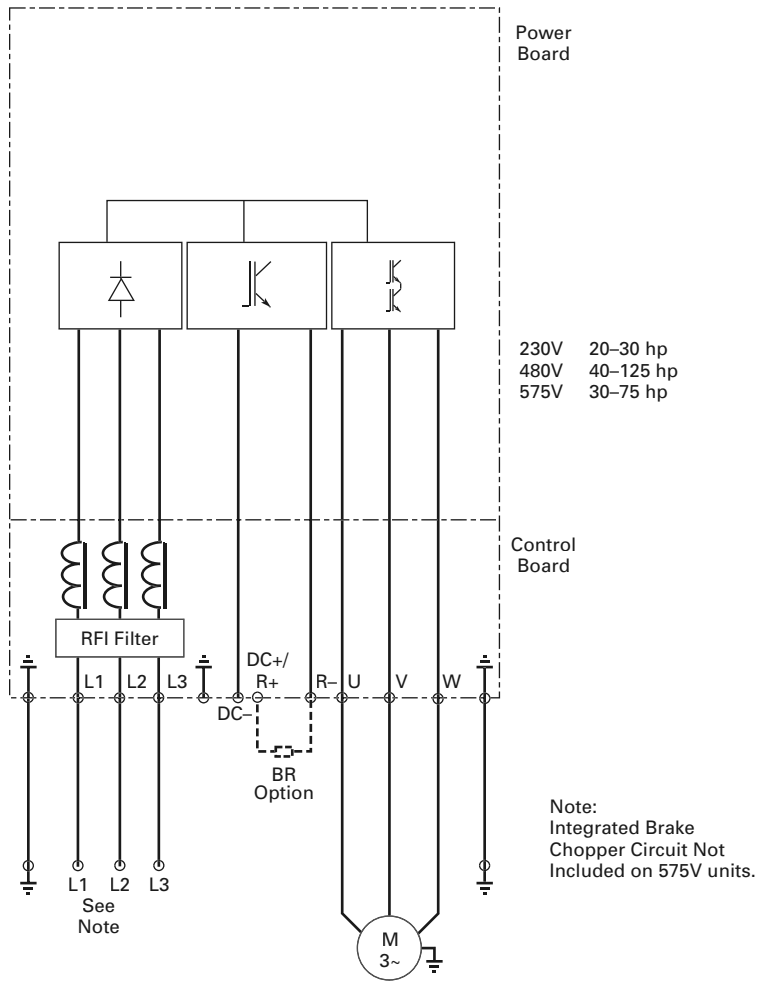

Note: When using a single-phase supply, for units rated for such, connect the input power to terminals L1 and L2. Consult Eaton for more information.

Power Wiring

Principle Wiring Diagram of SVX9000/SPX9000 Power Unit, FR9 to FR10

The dotted lines refer to components present in FR9 but not in FR10.

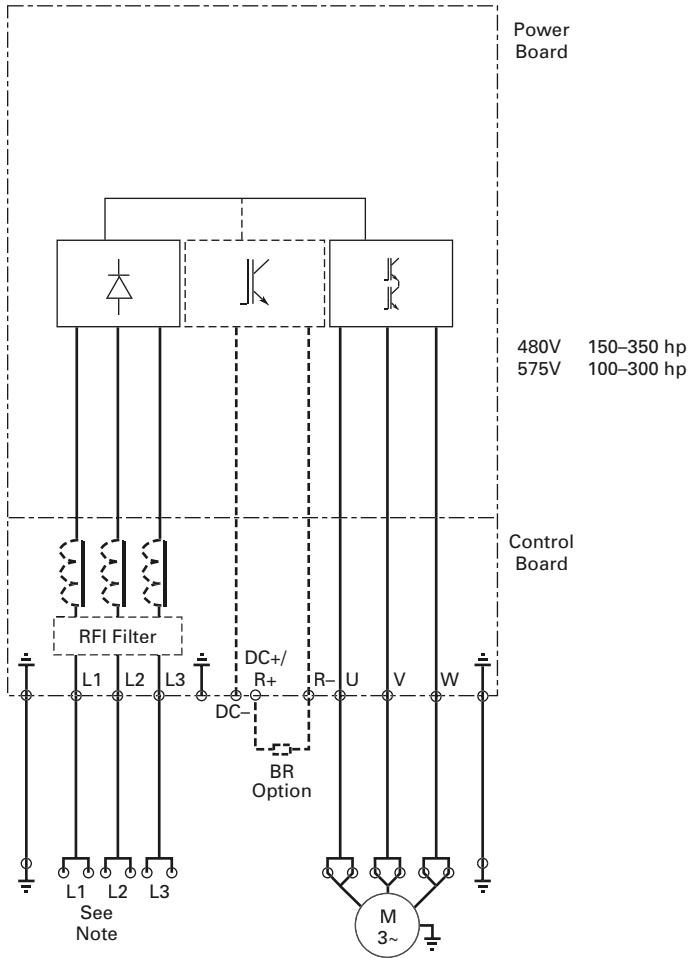

Power and Motor Wiring Terminals

Frame Size: FR4 (230V, 3/4–3 hp and 480V, 1–5 hp)

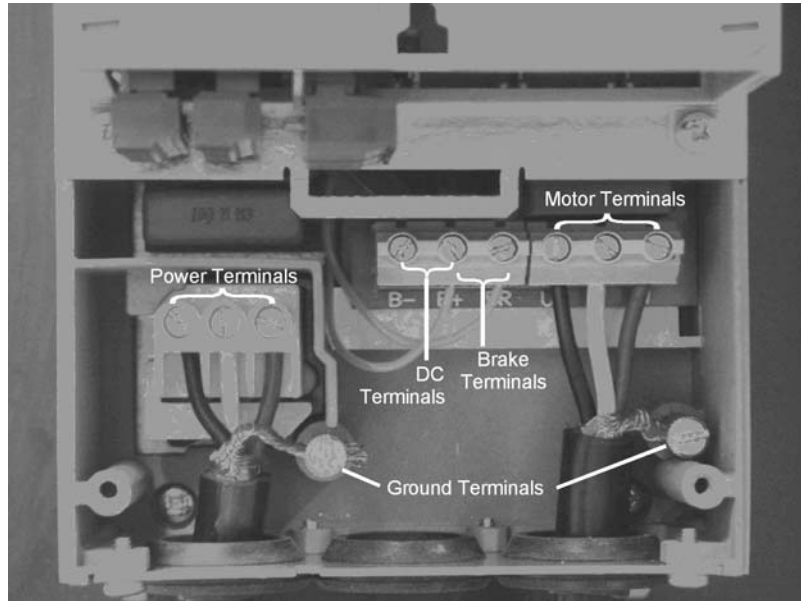

Frame Size: FR5 (230V, 5–7-1/2 hp and 480V, 7-1/2–15 hp)

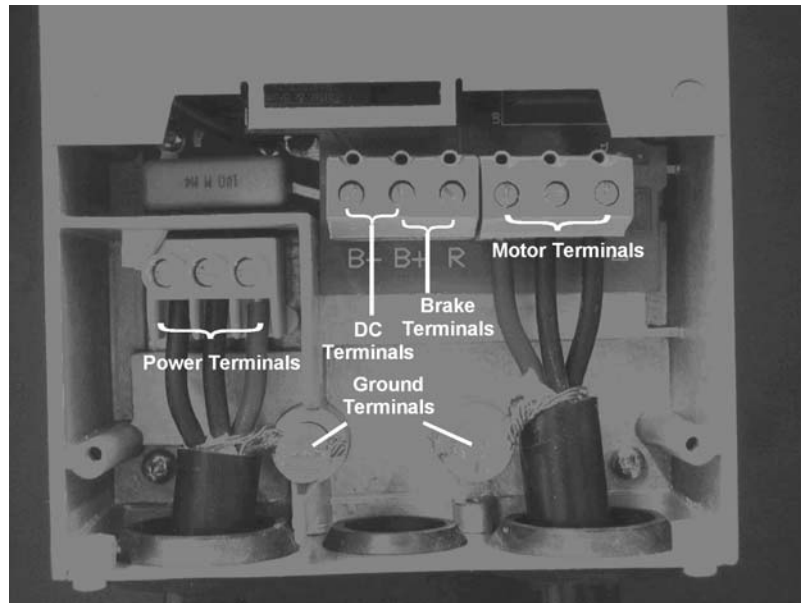

Power Wiring

Frame Size: FR6 (230V, 10–15 hp, 480V, 20–30 hp and 575V, 2–25 hp)

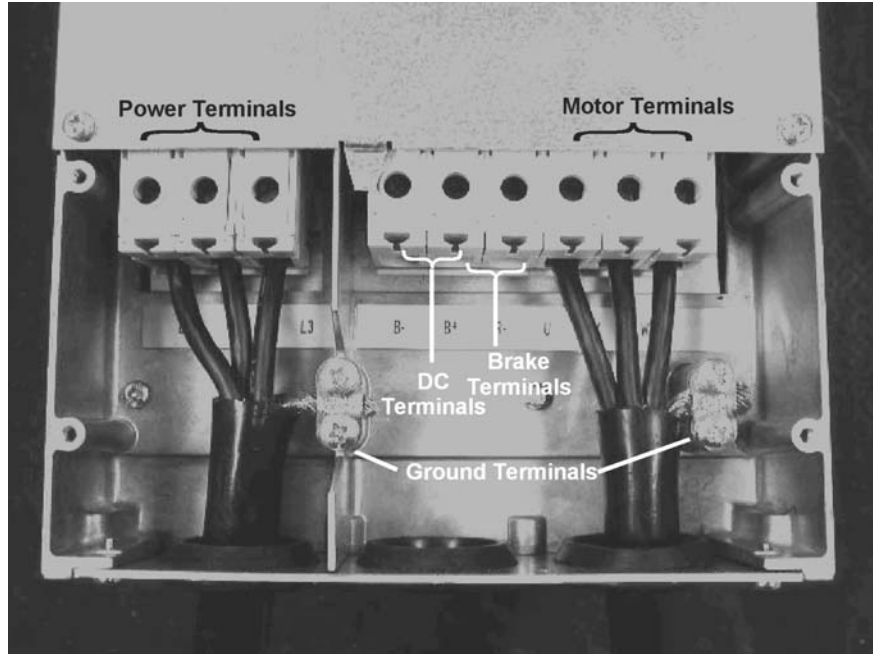

Frame Size: FR7 (230V, 20–30 hp, 480V, 40–60 hp and 575V, 30–40 hp)

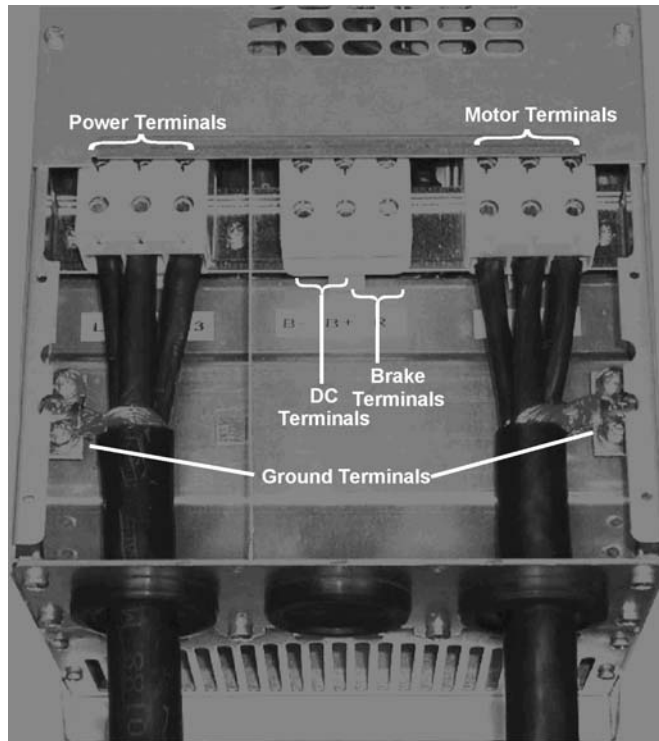

Frame Size: FR8 (480V, 75–125 hp and 575V, 50–75 hp)



Supplied only when
brake chopper
included with drive

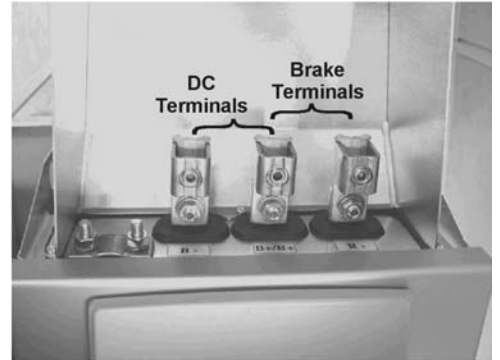
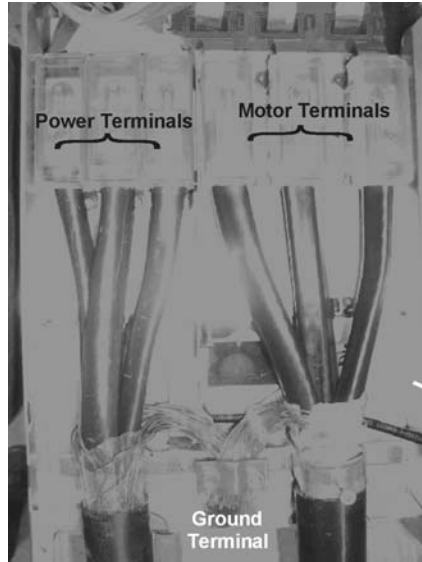

Frame Size: FR9 (480V, 150–200 hp and 575V, 100–175 hp)



Checking the Cable and Motor Insulation

1. Check the motor cable insulation as follows:

Disconnect the motor cable from terminals U, V, and W of the SVX9000/SPX9000 and from the motor.

Measure the insulation resistance of the motor cable between each phase conductor as well as between each phase conductor and the protective ground conductor.

The insulation resistance must be >1M ohms.

2. Check the input power cable insulation as follows:

Disconnect the input power cable from terminals L1, L2, and L3 of the SVX9000/SPX9000 and from the utility line feeder.

Measure the insulation resistance of the input power cable between each phase conductor as well as between each phase conductor and the protective ground conductor.

The insulation resistance must be >1M ohms.

3. Check the motor insulation as follows:

Disconnect the motor cable from the motor and open any bridging connections in the motor connection box.

Measure the insulation resistance of each motor winding. The measurement voltage must equal at least the motor nominal voltage but not exceed 1000V.

The insulation resistance must be >1M ohms.

Control Wiring

General Information

The control unit of the SVX9000/SPX9000 consists of the control board and various option boards that plug into the five slot connectors (A to E) of the control board.

Galvanic isolation of the control terminals is provided as follows:

- The control connections are isolated from power, and the GND terminals are permanently connected to ground
- The digital inputs are galvanically isolated from the I/O ground
- The relay outputs are double-isolated from each other at 300 Vac

Option Board General Information

The SVX9000/SPX9000 series drives can accommodate a wide selection of *expander* and *adapter option boards* to customize the drive for your application needs.

The drive's control unit is designed to accept a total of five option boards. Option boards are available for normal analog and digital inputs and outputs, communication, and additional application-specific hardware.

The SVX9000/SPX9000 factory-installed standard option board configuration includes an A9 I/O board and an A2 relay output board, which are installed in slots A and B. For information on additional option boards, see the *9000X Series Drives Option Board User Manual*.

Option Board Slots

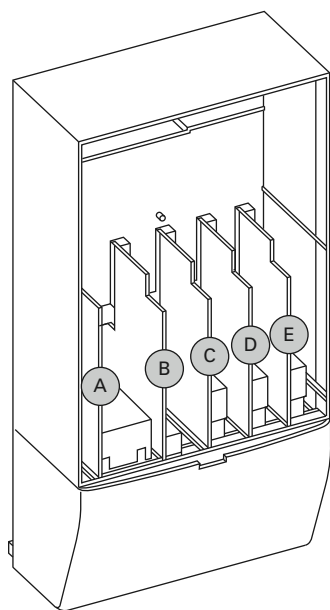

Control Wiring Guidelines

Wire the control terminals using the following guidelines:

- The control wires shall be at least AWG 20 (0.5 mm²) shielded cables
- The maximum wire size is AWG 14 (2.5 mm²) for the relay terminals and AWG 16 (1.5 mm²) for all other terminals
- The tightening torques for the option board terminals are listed in the table below

Tightening Torques of Terminals

Terminal Screw	Tightening Torque	
	in-lbs	Nm
Relay and thermistor terminals (M3 screw)	4.5	0.5
Other terminals (M2.6 screw)	2.2	0.25

Control Wiring

Control Wiring Instructions

Step

Example

1. Unlock the bottom cover by turning the locking screw 90 degrees counterclockwise.



2. Remove the bottom cover by rotating the cover toward you on the base hinges, then lifting the cover away from the base.



3. Wire the control terminals by following the details for the specific option boards shown on the following pages.

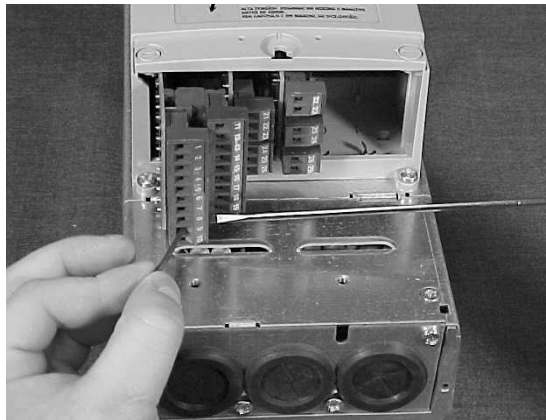

Note: For ease of access, the option board terminal blocks can be unplugged for wiring.

Control Wiring Details

Wiring Option Board A9

Option Board A9 Wiring Diagram

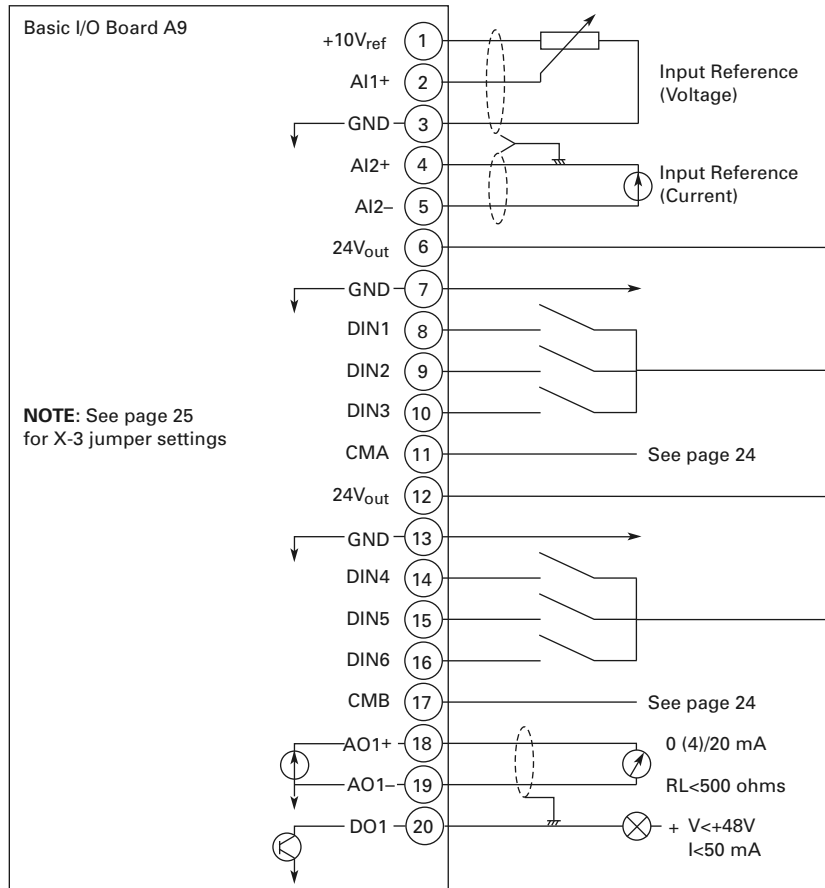

Control Wiring

Option Board A9 Terminal Descriptions

Terminal	Signal	Description and Parameter Reference
1	+10V _{ref}	Reference voltage Maximum current 10 mA
2	AI1+	Analog input, voltage
3	GND	Analog input common
4	AI2+	Analog input
5	GND/AI2–	Analog input common
6	24V _{out}	24V control voltage (bi-directional)
7	GND	I/O ground
8	DIA1	Digital input 1
9	DIA2	Digital input 2
10	DIA3	Digital input 3
11	CMA	Digital input common A for DIN1, DIN2 and DIN3
12	24V _{out}	24V control voltage (bi-directional)
13	GND	I/O ground
14	DIB4	Digital input 4
15	DIB5	Digital input 5
16	DIB6	Digital input 6
17	CMB	Digital input common B for DIN4, DIN5 and DIN6
18	A01+	Analog signal (+output)
19	A01–	Analog output common
20	DO1	Digital output 1

Option Board A9 Jumper Location and Settings

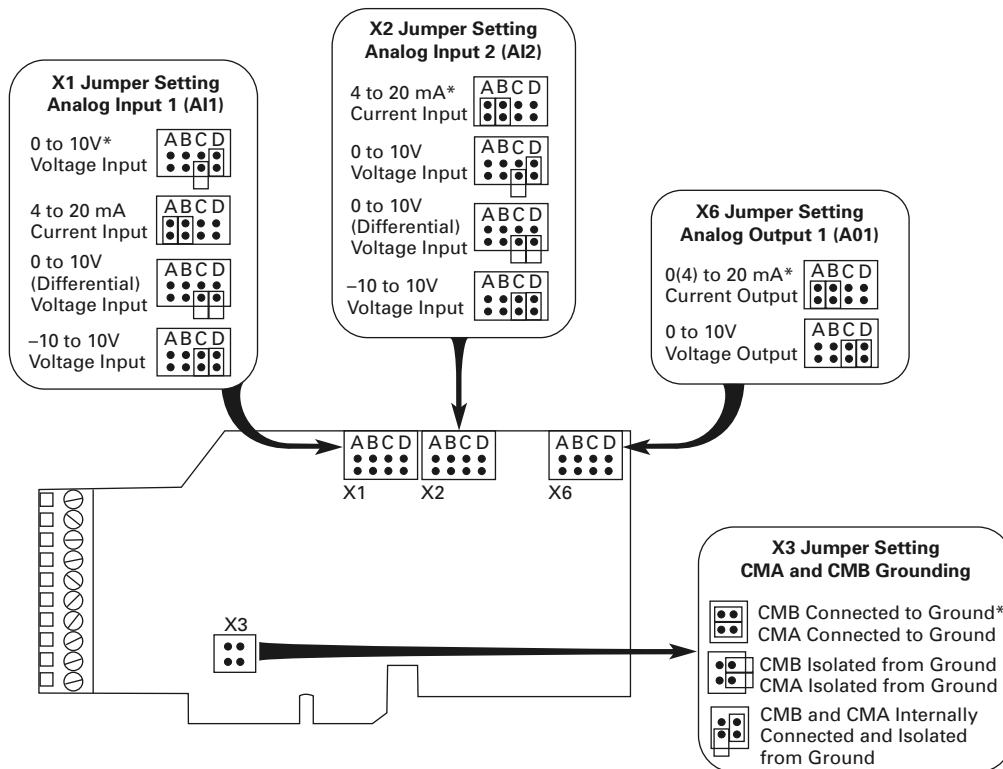

Control Wiring

Wiring Option Board A2

Option Board A2 Wiring Diagram

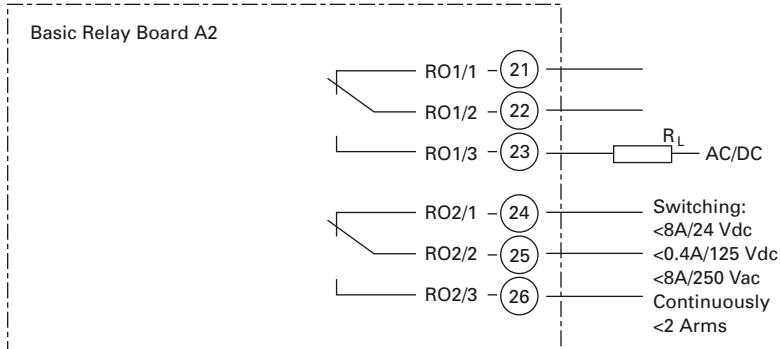

Option Board A2 Terminal Descriptions

Terminal	Signal	Technical Information
21	RO1/1	Normally closed (NC)
22	RO1/2	Common
23	RO1/3	Normally open (NO)
		Switching capacity: 24 Vdc/8A 250 Vac/8A 125 Vdc/0.4A Min switching load: 5V/10 mA Continuous capacity: <2 Arms
24	RO2/1	Normally closed (NC)
25	RO2/2	Common
26	RO2/3	Normally open (NO)
		Switching capacity: 24 Vdc/8A 250 Vac/8A 125 Vdc/0.4A Minimum switching load: 5V/10 mA Continuous capacity: <2 Arms

Option Board A2 Terminal Locations

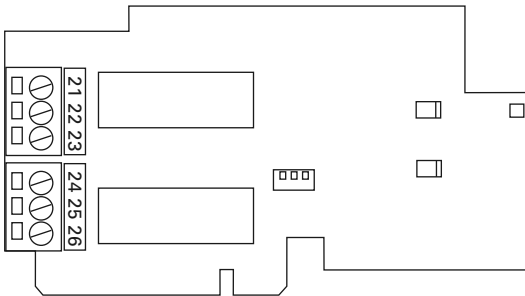

Inverting the Digital Input Signal

The active signal level depends on which potential the common inputs CMA and CMB (terminals 11 and 17) are connected to. The alternatives are either +24V or ground (0V). See figures below.

The 24V control voltage and the ground for the digital inputs and the common inputs (CMA, CMB) can be sourced from either the internal 24V supply or an external supply.

Positive Logic

Positive logic (+24V is the active signal) = the input is active when the switch is closed.

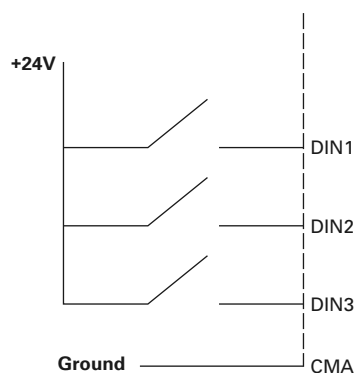

Negative Logic

Negative logic (0V is the active signal) = the input is active when the switch is closed.

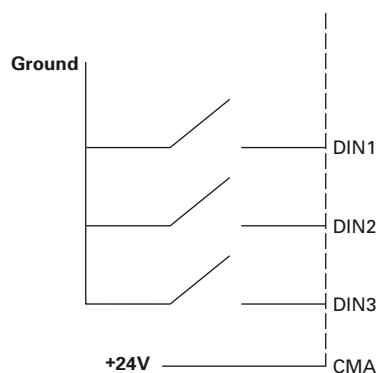

Menu Information

Keypad Operation

Keypad and Display

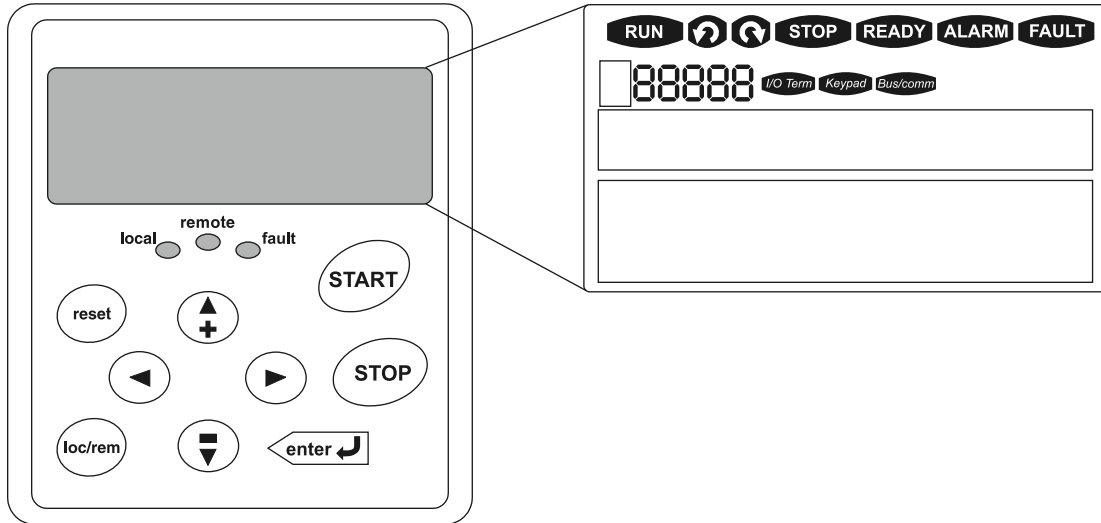









LCD Status Indicators

Indicator	Description
	Run Indicates that the SVX9000/SPX9000 is running and controlling the load. Blinks when a stop command has been given but the SVX9000/SPX9000 is still ramping down.
	Counterclockwise Operation The output phase rotation is BAC, corresponding to counterclockwise rotation of most motors.
	Clockwise Operation The output phase rotation is ABC, corresponding to clockwise rotation of most motors.
	Stop Indicates that the SVX9000/SPX9000 is stopped and not controlling the load.
	Ready Indicates that the SVX9000/SPX9000 is ready to be started.
	Alarm Indicates that there is one or more active drive alarm(s).
	Fault Indicates that there is one or more active drive fault(s).
	I/O Terminal Indicates that the I/O terminals have been chosen for control.
	Keypad Indicates that the keypad has been chosen for control.
	Bus/Communications Indicates that the communications bus control has been chosen for control.

LED Status Indicators, continued

Indicator	Description
local	<p>Local—Steady Illumination Indicates that the SVX9000/SPX9000 is ready to be started and operated from the local mode.</p> <p>Local—Flashing Indicates that the SVX9000/SPX9000 is ready for operating command to select local or remote operation.</p>
remote	<p>Remote Indicates that the SVX9000/SPX9000 is operating and controlling the load remotely.</p>
fault	<p>Fault Indicates that there is one or more active drive fault(s).</p>

Navigation Buttons

Button	Description
	<p>Start This button operates as the START button for normal operation when the “Keypad” is selected as the active control.</p>
	<p>Enter This button is used in the parameter edit mode to save the parameter setting and move to the next parameter ...</p> <ul style="list-style-type: none"> • to reset the Fault History if pressed while in the “Fault History” menu • to confirm the acceptance of a change • to change a virtual button status while in the “Button” menu • to confirm the start-up list at the end of the Startup Wizard • when the “Operate” menu is active, to exit the “Operate” submenu
	<p>Stop This button has two integrated operations. The button operates as STOP button during normal operation ...</p> <ul style="list-style-type: none"> • motor STOP from the keypad, which is always active unless disabled by the “StopButtonActive” parameter • used to reset the active faults
	<p>Reset Resets the active faults.</p>
	<p>Local/Remote Switches between LOCAL and REMOTE control for start, speed reference, and reverse functions. The control locations corresponding to local and remote can be selected within an application.</p>
	<p>Left Arrow</p> <ul style="list-style-type: none"> • Navigation button, movement to left • In parameter edit mode, exits mode, backs up one step • Cancels edited parameter (exit from a parameter edit mode) • When in “Operate” menu will move backward through menu • At end of “Startup Wizard,” repeats the “Startup Wizard” setup menu
	<p>Right Arrow</p> <ul style="list-style-type: none"> • Navigation button, movement to right • Enter parameter group mode • Enter parameter mode from group mode • When in “Operate” menu will move forward through menu
	<p>Up and Down Arrows</p> <ul style="list-style-type: none"> • Move either up or down a menu list to select the desired menu item • Editing a parameter/password, while the active digit/character is scrolled • Increase/decrease the reference value of the selected parameter • In the “Operate” menu, will cause the display of the current reference source and value and allow its change if the keypad is the active reference source. Used to set the password (if defined) when leaving the “Operate” menu • Scroll through the “Active Faults” menu when the SVX9000/SPX9000 is stopped
	

Menu Information

Menu Navigation

Navigation Tips

- To navigate within one level of a menu, use the up and down arrows
- To move deeper into the menu structure and back out, use the right and left arrows
- To edit a parameter, navigate to show that parameter's value, and press the right arrow button to enter the edit mode. In edit mode, the parameter value will flash
- When in edit mode, the parameter value can be changed by pressing the up or down arrow keys
- When in edit mode, pressing the right arrow a second time will allow you to edit the parameter value digit by digit
- To confirm the parameter change you must press the ENTER button. *The value will not change unless the ENTER button is pushed*
- Some parameters cannot be changed while the SVX9000/SPX9000 is running. The screen will display LOCKED if you attempt to edit these parameters while the drive is running. Stop the drive to edit these parameters. See the appropriate application manual for identification of these parameters specific to your chosen application

Main Menu

The data on the control keypad are arranged in menus and submenus. The first menu level consists of M1 to M8 and is called the Main Menu. The structure of these menus and their submenus is illustrated below. Some of the submenus will vary for each application choice.

Main Menu Navigation

Menu Navigation:



Up Arrow — The up arrow advances to the next menu item. For example, pressing the up arrow once will advance from M1 to M2.



Down Arrow — The down arrow backs up to the previous menu item. For example, pressing the down arrow once will back up from M2 to M1.



Right Arrow — The right arrow will advance to the next level in the menu. For example, pressing the right arrow once will advance from M2 to R2.1.



Left Arrow — The left arrow will back up one level in the menu structure. For example, pressing the left arrow once will back up from R2.1 to M2.

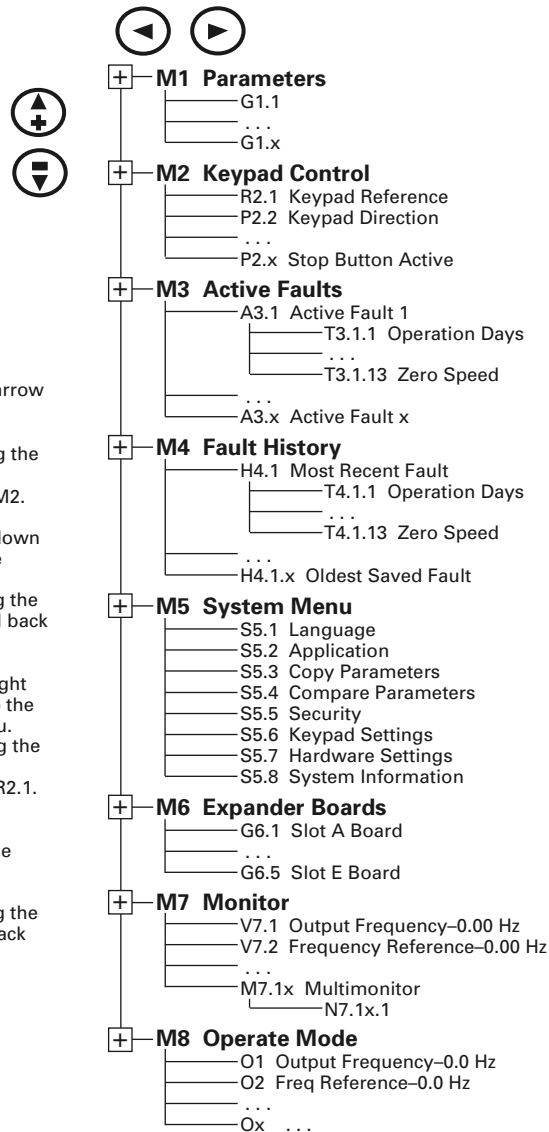

Menu Information

Parameter Menu (M1)

The Parameter Menu is a single or multi-level menu dependent upon the application in use, arranged by the parameter group items. The figure below illustrates this for the standard application. Parameters and parameter groups are explained in further detail in the appropriate application manual.

Parameter Menu Structure Example

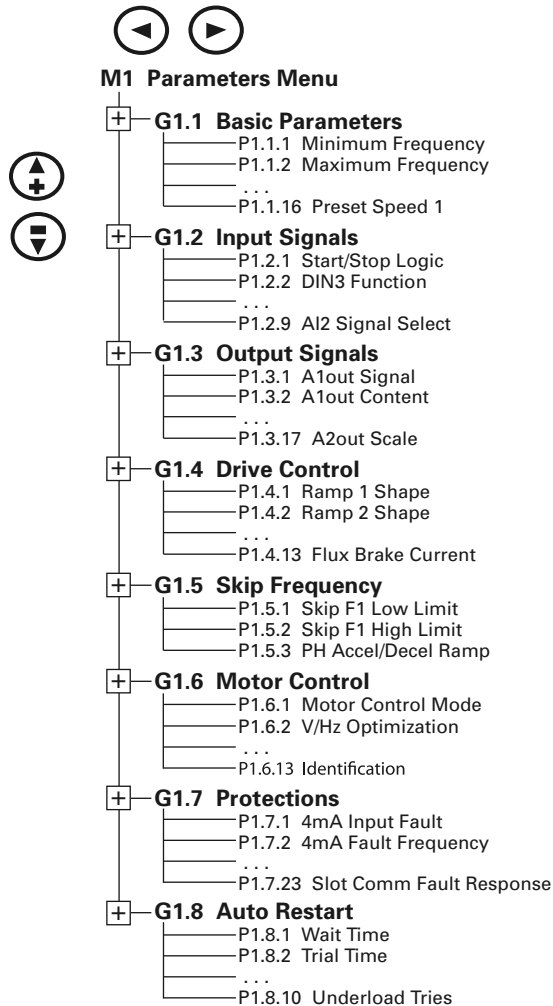

Keypad Control Menu (M2)

In the Keypad Control Menu, you can set the frequency reference, choose the motor direction for keypad operation, and determine if the STOP button will be active at all times. See figure below.

M2 Keypad Control Menu

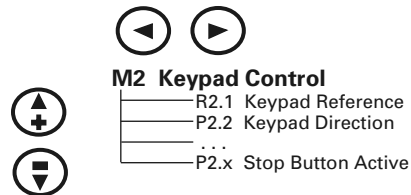

R2.1	Range: Min. Frequency—Max. Frequency Units: Hertz	
Keypad Reference	<i>KEYPAD REFERENCE</i> This displays and allows the operator to edit the keypad frequency reference. A change takes place immediately. This reference value will not influence the output frequency unless the keypad has been selected as the active control place.	
P2.2	Range: Forward, Reverse	Default: Forward
Keypad Direction	<i>KEYPAD DIRECTION</i> This allows the operator to change the rotation direction of the motor. This setting will not influence the rotation direction of the motor unless the keypad has been selected as the active control place.	
P2.3 ①	Range: Yes, No	Default: Yes
Stop Button Active	<i>STOPBUTTONACTIVE</i> By default, pushing the STOP button will always stop the motor regardless of the selected control place. If this parameter is set to No , the STOP button will stop the motor only when the keypad has been selected as the active control place .	

Note

① This parameter number varies for different applications.

Menu Information

Active Faults Menu (M3)

When a fault occurs, the SVX9000/SPX9000 stops. The sequence indication F1, the fault code, a short description of the fault, and the fault type symbol will appear on the display. In addition, the indication FAULT or ALARM is displayed and, in case of a FAULT, the red LED on the keypad starts to blink. If several faults occur simultaneously, the sequence of active faults can be browsed with the Browser buttons. See figure below.

The active faults memory can store the maximum of 10 faults in the sequential order of appearance. The fault remains active until it is cleared with either the STOP or RESET buttons, or with a reset signal from the I/O terminal. Upon fault reset, the display will be cleared and will return to the same state it was before the fault trip.

Active Fault Display Example

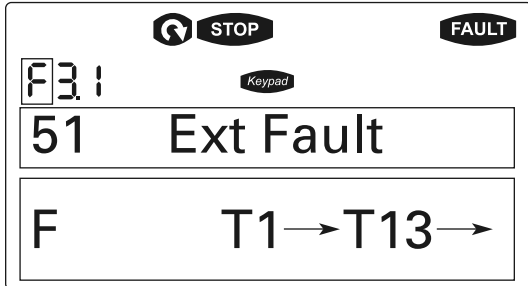

 **CAUTION**

Remove any External Start signals or permissives before resetting the fault to prevent an unintentional restart of the

SVX9000/SPX9000, which could result in personal injury or equipment damage.

Fault Type Range: A, F, AR, FT

FAULT TYPE

There are four different types of faults. These faults and their definitions are given in the table below

Fault Types

Fault Type	Fault Name	Description
A	Alarm	This type of fault is a sign of an unusual operating condition. It does not cause the drive to stop, nor does it require any special actions. The "A fault" remains in the display for about 30 seconds.
F	Fault	An "F fault" is a kind of fault that makes the drive stop. Actions need to be taken in order to restart the drive.
AR	Auto-Restart Fault	If an "AR fault" occurs, the drive will also stop immediately. The fault is reset automatically and the drive tries to restart the motor. If the restart is not successful, a fault trip (FT) occurs.
FT	Fault Trip	If the drive is unable to restart the motor after an AR fault, an FT fault occurs. The effect of the "FT fault" is the same as that of the F fault—the drive is stopped.

Fault Code Range: 1–54

Fault codes indicate the cause of the fault. A list of fault codes, their descriptions, and possible solutions can be found starting on **Page 81**.

Fault Time Data Record Range: T.1–T.13

In this menu, important data recorded at the time the fault is available. This feature is intended to help the user or the service person to determine the cause of fault. The table below indicates the information that is recorded.

Fault Time Data

Fault Type	Units	Description
T.1 ^①	D	Counted operation days (Fault 43: Additional code)
T.2 ^①	hh:mm:ss (d)	Counted operation hours (Fault 43: Counted operation days)
T.3	Hz hh:mm:ss	Output frequency (Fault 43: Counted operation hours)
T.4	A	Motor current
T.5	V	Motor voltage
T.6	%	Motor power
T.7	%	Motor torque
T.8	V	DC bus voltage
T.9	°C	Unit temperature
T.10	—	Run status
T.11	—	Direction
T.12	—	Warnings
T.13	—	Zero speed

Notes

^① Real-time record.

If real-time is set, T.1 and T.2 will appear as follows:

T.1 yyyy-mm-dd Counted operation days (Fault 43: Additional code)

T.2 hh:mm:ss.sss Counted operation hours (Fault 43: Counted operation days)

Menu Information

Fault History Menu (M4)

All faults are stored in the Fault History Menu, which can be viewed by using the Browser buttons. Additionally, the Fault time data record pages are accessible for each fault as in the Active Faults Menu described earlier. See figure below.

The SVX9000/SPX9000's memory can store a maximum of 30 faults, in the order of appearance. If there are 30 uncleared faults in the memory, the next occurring fault will erase the oldest fault from the memory.

Sample Fault History Display

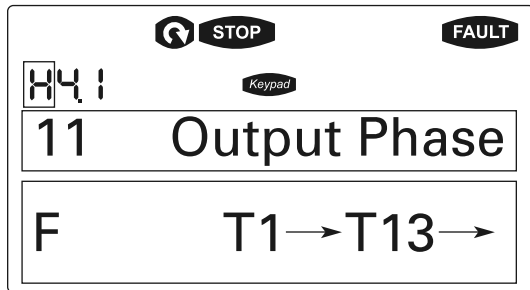

Note: Pressing the ENTER button for three seconds will clear the entire fault history.

System Menu (M5)

The controls associated with the general use of the drive, such as application selection, customized parameter sets, or information about the hardware and software are located in the System Menu. Password protection can be activated by parameter **S5.5.1**.

Descriptions of the system menu parameters are illustrated in the figure below.

System Menu Structure

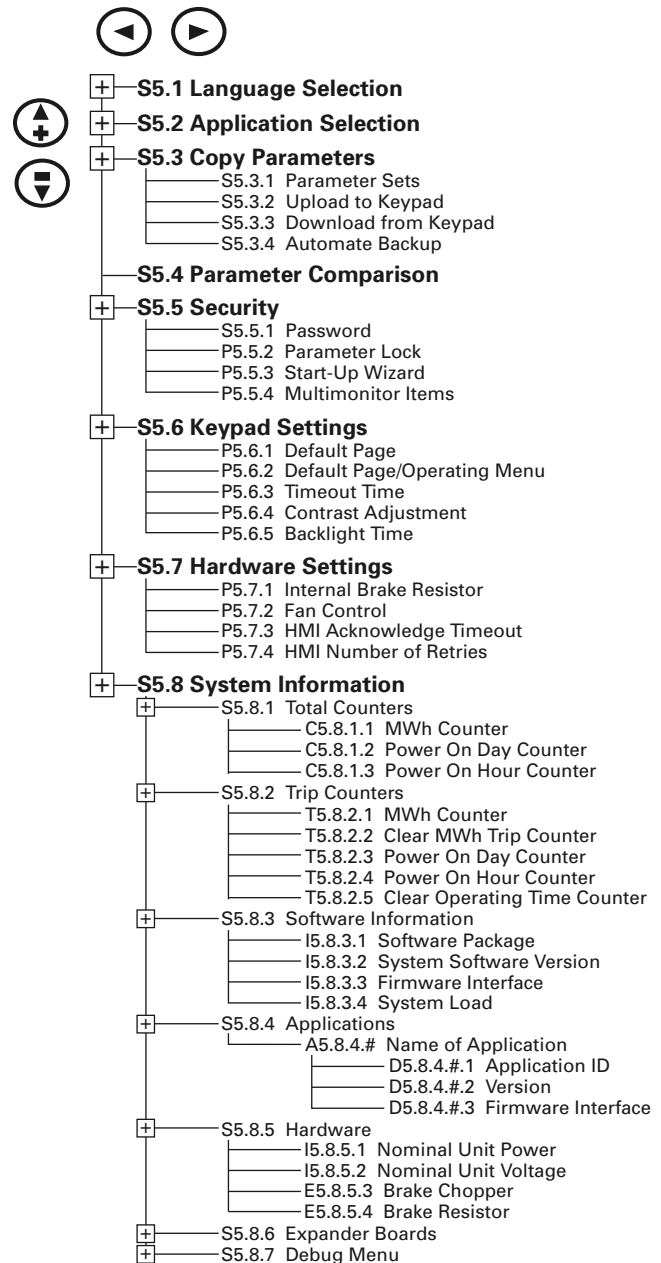

System Menu Parameters

S5.1	Range: English, Spanish, French, Portuguese	Default: English						
Language Selection	<p><i>LANGUAGE</i></p> <p>This parameter offers the ability to control the SVX9000/SPX9000 through the keypad in the language of your choice. Available languages are: English, Spanish, French, and Portuguese.</p>							
S5.2		Default: Basic						
Application Selection	<p><i>APPLICATION</i></p> <p>This parameter sets the active application.</p> <p>When changing applications, you will be asked if you want the parameters of the new application to be uploaded to the keypad. If you wish to load the new application parameters, push the ENTER button. Pushing any other button saves the parameters of the previously used application in the keypad.</p>							
System Menu Copy Parameter Options (S5.3)								
<p>The parameter copy function is used when the operator wants to copy one or all parameter groups from one drive to another. All the parameter groups are first uploaded to the keypad, the keypad is connected to another drive and the parameter groups are downloaded to it (or possibly back to the same drive).</p>		<p>Note: Before any parameters can be successfully copied from one drive to another, the drive must be stopped when the parameters are downloaded to it.</p>						
S5.3.1								
Parameter Sets	<p><i>PARAMETER SETS</i></p> <p>This parameter allows you to reload the factory default parameter values, and to store and load two customized parameter sets.</p>							
S5.3.2								
Upload to Keypad	<p><i>UP TO KEYPAD</i></p> <p>This function uploads all existing parameter groups to the keypad.</p>							
S5.3.3	Range: 0–3	Default: 0 (All parameters)						
Download from Keypad	<p><i>DOWN FROM KEYPAD</i></p> <p>This function downloads one or all parameter groups from the keypad to the drive.</p> <table> <tr> <td>0</td> <td>All parameters</td> </tr> <tr> <td>1</td> <td>All, no motor</td> </tr> <tr> <td>2</td> <td>Application parameters</td> </tr> </table>		0	All parameters	1	All, no motor	2	Application parameters
0	All parameters							
1	All, no motor							
2	Application parameters							
S5.3.4	Range: Yes, No	Default: Yes						
Automatic Backup	<p><i>AUTO.BACKUP</i></p> <p>This parameter activates and deactivates the parameter backup function. When the parameter backup function is activated, the keypad makes a copy of the parameters and settings in the currently active application. When applications are changed, you will be asked if you wish the parameters of the new application to be uploaded to the keypad. For this to happen, push the ENTER button. If you wish to keep the copy of the parameters of the previously used application saved in the keypad, push any other button.</p> <p>Note: Parameters saved in the parameter settings of S5.3.1 will be deleted when applications are changed. If you want to transfer the parameters from one application to another, you have to upload them to the keypad first.</p>							

Menu Information

System Menu Parameter Comparison Options (S5.4)

S5.4

Parameter Comparison

PARAMETER COMPARISON

With the Parameter Comparison function, you can compare the actual parameter values to the values of your customized parameter sets and those loaded to the control keypad.

The actual parameter values are first compared to those of the customized parameter Set1. If no differences are detected, a "0" is displayed on the lowermost line of the keypad.

If any of the parameter values differ from those of the Set1 parameters, the number of the deviations is displayed together with the symbol P (e.g. P1 → P5 = five deviating values).

By pressing the right arrow button once again, you will see both the actual value and the value it was compared to. In this display, the value on the description line (in the middle) is the default value, and the one on the value line (lowermost line) is the edited value. You can also edit the actual value by pushing the right arrow button.

Actual values can also be compared to Set2, factory settings, and the keypad set values.

Security Menu Parameter Options (S5.5)

Note: The Security submenu is protected with a password.
Store the password in a safe place.

S5.5.1

Range: 0–65535

Default: 0

Password

PASSWORD

The application selection can be protected against unauthorized changes with the password function. When the password function is enabled, the user will be prompted to enter a password before application changes, parameter value changes, or password changes.

By default, the password function is not in use. If you want to activate the password, change the value of this parameter to any number between 1 and 65535. The password will be activated after the timeout time (**Timeout Time**) has expired.

To deactivate the password, reset the parameter value to 0.

P5.5.2

Range: ChangeEnable, ChangeDisabl

Default: ChangeEnable

Parameter Lock

PARAMETER LOCK

This function allows the user to prohibit changes to the parameters. If the parameter lock is activated the text ***LOCKED*** will appear on the display if you try to edit a parameter value.

Note: This function does not prevent unauthorized editing of parameter values.

P5.5.3

Range: Yes, No

Default: No

Startup Wizard

STARTUP WIZARD

The Startup Wizard facilitates commissioning the SVX9000/SPX9000. If selected active, the Startup Wizard prompts the operator for the language and application desired and then advances through the start-up parameter list. After completion it allows the user to repeat the Startup Wizard or return to the default page, the operate menu. The Startup Wizard is always active for the initial power up of the SVX9000/SPX9000.

P5.5.4

Range: ChangeEnable, ChangeDisabl

Default: ChangeEnable

Multimonitor Items

MULTIMON.ITEMS

The keypad display can display three actual monitored values at the same time. This parameter determines if the operator is allowed to replace the values being monitored with other values.

Keypad Settings (S5.6)

There are five parameters (**Default Page** to **Backlight Time**) associated with the keypad operation:

P5.6.1		Default: 0
Default Page	<i>DEFAULT PAGE</i> This parameter sets the view to which the display automatically moves as the Timeout Time expires or when the keypad power is switched on. If the default page value is 0, this function is not activated, that is, the last displayed page remains on the keypad display.	
P5.6.2		
Default Page in the Operating Menu	<i>DEFAULT PAGE/OM</i> Here you can set the location in the operating menu to which the display automatically moves as the set Timeout Time expires, or when the keypad power is switched on. See setting of Default Page parameter above.	
P5.6.3	Range: 0–65,535 Units: Seconds	Default: 30
Timeout Time	<i>TIMEOUT TIME</i> The Timeout Time setting defines the time after which the keypad display returns to the Default Page . Note: If the Default Page value is 0, the Timeout Time setting has no effect.	
P5.6.4		
Contrast Adjustment	<i>CONTRAST ADJUSTMENT</i> If the display is not clear, you can adjust the keypad contrast with this parameter.	
P5.6.5	Range: 1–65,535 or Forever Units: Minutes	Default: 10
Backlight Time	<i>BACKLIGHT TIME</i> This parameter determines how long the backlight stays on before going out. You can select any time between 1 and 65,535 minutes or "Forever".	

Menu Information

Hardware Settings (S5.7)

The Hardware Settings submenu (S5.7) provides parameters for setting information on Internal brake resistor connection, Fan control, Keypad acknowledge timeout, and Keypad retries.

P5.7.1	Range: Connected–Not Connected	Default: Connected
Internal Brake Resistor Connection	<p><i>INTERBRAKES</i></p> <p>With this function, you tell the SVX9000/SPX9000 whether the internal brake resistor is connected or not.</p> <p>If your drive has an internal brake resistor, the default value of this parameter is “Connected”. However, if it is necessary to increase braking capacity by installing an external brake resistor, or if the internal brake resistor is disconnected, it is advisable to change the value of this function to “Not Connected” in order to avoid unnecessary fault trips.</p> <p>Note: The brake resistor is available as an option for all drives. It can be installed internally in frame sizes FR4 to FR6.</p>	
5.7.2	Range: Continuous, Temperature, First Start, and Calc Temp	Default: Continuous
Fan Control	<p><i>FAN CONTROL</i></p> <p>This function allows you to control the SVX9000/SPX9000’s cooling fan. You can set the fan to run:</p> <ol style="list-style-type: none">1 Continuous—fan runs continuously.2 Temperature—based on the temperature of the unit. The fan is switched on automatically when the heatsink temperature reaches 60°C. The fan receives a stop command when the heatsink temperature falls to 55°C. The fan runs for about a minute after receiving the stop command or switching on the power, as well as after changing the value from “Continuous” to “Temperature”.3 First Start—after power up the fan is stopped until the run command is given and then fan runs continuously. This is mainly made for common DC bus systems to prevent cooling fans to load charging resistors on power up moment.4 Calc Temp—starting of cooling fan is based on calculated IGBT-temperature. When IGBT temperature = 40°C, fan starts and when temperature falls down to 30°C, fan stops. <p>Note: The fan runs continuously, regardless of this setting, when the SVX9000/SPX9000 is in RUN state.</p>	
P5.7.3	Range: 200–5,000 Units: ms	Default: 200
Keypad Acknowledge Timeout	<p><i>KEYPAD ACK TIMEOUT</i></p> <p>This function allows the user to change the timeout of the keypad acknowledgement time.</p> <p>Note: If the SVX9000/SPX9000 has been connected to a PC with a serial cable, the default values of Keypad Acknowledge Timeout and Number of Retries to Receive Keypad Acknowledgement must not be changed.</p> <p>If the SVX9000/SPX9000 has been connected to a PC via a modem and there is delay in transferring messages, the value of Keypad Acknowledge Timeout must be set according to the delay as follows:</p> <p><i>Example:</i></p> <ul style="list-style-type: none">• Transfer delay between the SVX9000/SPX9000 and the PC is found to be 600 ms• The value of Keypad Acknowledge Timeout is set to 1200 ms (2 x 600, sending delay + receiving delay)• The corresponding setting is then entered in the [Misc] section of the file 9000XDrive.ini:<ul style="list-style-type: none">• Retries = 5• AckTimeOut = 1200• TimeOut = 5000 <p>It must also be considered that intervals shorter than the Keypad Acknowledge Timeout time cannot be used in SVX9000/SPX9000 drive monitoring.</p>	
P5.7.4	Range: 1–10	Default: 5
Number of Retries to Receive Keypad Acknowledgement	<p><i>KEYPAD RETRY</i></p> <p>With this parameter, you can set the number of times the drive will try to receive an acknowledgement when it has not been received within the acknowledgement time (Keypad Acknowledge Timeout) or if the received acknowledgement is faulty.</p>	

System Information (S5.8)

This section contains hardware and software information as well as operation information.

S5.8.1**Total Counters***TOTAL COUNTERS*

In the **Total Counters** page, you will find information related to the SVX9000/SPX9000 operating times, that is, the total numbers of MWh, operating days and operating hours. See table below.

Unlike the counters for the **Trip Counters**, these counters cannot be reset.

Note: The Power On time counters, days and hours, operate whenever power is applied to the SVX9000/SPX9000.

Total Counters

Number	Name	Description
C5.8.1.1	MWh counter	Megawatt hours total operation time counter
C5.8.1.2	Power On day counter	Number of days the SVX9000/SPX9000 has been supplied with power
C5.8.1.3	Power On hour counter	Number of hours the SVX9000/SPX9000 has been supplied with power

S5.8.2**Trip Counters***TRIP COUNTERS*

The **Trip Counters** are counters whose values can be reset to zero. The resettable counters are shown in the table below.

Trip Counters

Number	Name	Description
T5.8.2.1	MWh counter	Megawatts hours since last reset
P5.8.2.2	Clear MWh counter	Resets megawatts hours counter
T5.8.2.3	Power On day counter	Number of days the SVX9000/SPX9000 has been run since the last reset
T5.8.2.4	Power On hour counter	Number of hours the SVX9000/SPX9000 has been run since the last reset
P5.8.2.5	Clr Optime cntr	Resets the operating day and hour counters

Note: The **Trip Counters** operate only when the motor is running.

S5.8.3**Software Information***SOFTWARE*

The Software information page includes information on the following software related topics:

Software Information

Number	Name	Description
I5.8.3.1	Software package	SVX00031V003
I5.8.3.2	System software version	11.53.6536
I5.8.3.3	Firmware interface	4.37
I5.8.3.4	System load	G9.1

Menu Information

S5.8.4

Application Information

APPLICATIONS

The Application information page includes information on not only the application currently in use but also on all other applications loaded into the SVX9000/SPX9000. The information available is shown in the table below. Note that the "x" in the table refers to the sequential number of the application in the list.

Application Information

Name	Content
A4.8.4.x	Application name
D4.8.4.x.1	Application ID
D4.8.4.x.2	Version
D4.8.4.x.3	Firmware interface

S5.8.5

Hardware Information

HARDWARE

The Hardware information page provides information on the following hardware-related topics:

Hardware Information

Name	Content
I5.8.5.1	Nominal power of the unit
I5.8.5.2	Nominal voltage of the unit
E5.8.5.3	Brake chopper
E5.8.5.4	Brake resistor

S5.8.6

Expander Board Information

EXPANDER BOARDS

This parameter and its sub-items provide information about the basic and option boards plugged into the control board as shown in the table below. Note that the "x" in the table refers to the sequential number of the slot, with slot A being "1" and slot E being "5".

Expander Board Information

Name	Content
E5.8.6.x	Slot "x" board identification
E5.8.6.x.1	Operating state
E5.8.6.x.2	Software version

S5.8.7

Debug Menu

DEBUG

This menu is meant for advanced users and application designers. Contact the factory for any assistance needed.

Expander Board Menu (M6)

The Expander Board Menu makes it possible for the user to:

- See what expander boards are connected to the control board and
- Access and edit the parameters associated with the expander board

Expander Board Menu Structure

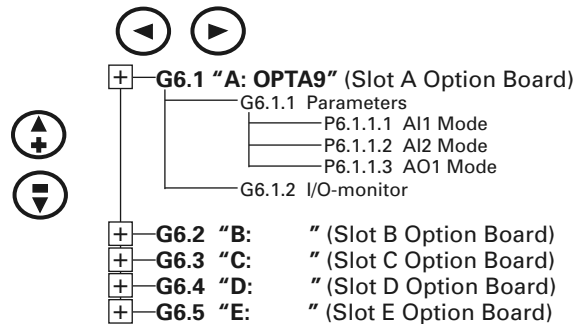

Example of Expander Board Parameters for Option Board A9

P6.1.1.1	Range: 1–5	Default: 3
AI1 Mode	<i>AI1 MODE</i> Analog Input 1 input options: 1 0 to 20 mA 2 4 to 20 mA 3 0 to 10V 4 2 to 10V 5 –10 to 10VP	
P6.1.1.2	Range: 1–5	Default: 1
AI2 Mode	<i>AI2 MODE</i> Analog Input 2 input options: 1 0 to 20 mA 2 4 to 20 mA 3 0 to 10V 4 2 to 10V 5 –10 to 10VP	
P6.1.1.3	Range: 1–4	Default: 1
AO1 Mode	<i>AO1 MODE</i> Analog Output 1 output options: 1 0 to 20 mA 2 4 to 20 mA 3 0 to 10V 4 2 to 10V	

Menu Information

Monitoring Menu (M7)

The Monitoring Menu items are meant for viewing parameter values during operation. Monitored values are updated every 0.3 second. Monitored items are identified by item numbers V7.1 to V1.xx, where “xx” varies by application. The table below provides an example of the monitored values for the **Standard** application.

Monitored parameters are not editable from this menu (see Parameter Menu [M1] to change parameter values).

Monitoring Menu Items—Standard Application Example

Code	Signal Name	Unit	Description
V7.1	Output frequency	Hz	Output frequency
V7.2	Frequency reference	Hz	Frequency reference setting
V7.3	Motor speed	rpm	Calculated motor speed
V7.4	Motor current	A	Measured motor current
V7.5	Motor torque	%	Calculated torque based on nominal motor torque
V7.6	Motor power	%	Calculated power based on nominal motor power
V7.7	Motor voltage	V	Calculated motor voltage
V7.8	DC bus voltage	V	Measured DC bus voltage
V7.9	Unit temperature	°C	Heatsink temperature
V7.10	Calculated motor temperature	°C	Calculated motor temperature based on the motor nameplate information and the calculated motor load
V7.11	Analog Input 1	V	Voltage input at terminals AI1+ and GND
V7.12	Analog Input 2	mA	Current input at terminals AI2+ and AI2-
V7.13	DIN1, DIN2, DIN3	—	Digital input status (see figure below)
V7.14	DIN4, DIN5, DIN6	—	Digital input status (see figure below)
V7.15	DO1, RO2, RO3	—	Digital and relay output status (see figure below)
V7.16	Analog I _{out}	mA	Current output at terminals AO1+ and AO1-

Digital Inputs— DIN1, DIN2, DIN3 Status

V1.13
DIN1, DIN2, DIN3
OFF ON OFF

Digital and Relay Outputs— DO1, RO1, RO2 Status

V1.15
DO1, RO1, RO2
OFF OFF ON

Digital Inputs— DIN4, DIN5, DIN6 Status

V1.14
DIN4, DIN5, DIN6
ON OFF OFF

Multimonitor (V7.17)

This parameter allows the viewing and selection (if allowed by system menu item, P5.5.4) of three simultaneously monitored items from the Monitored Menu Items shown in the table above. Use the right arrow key to select the item to be modified and then the up or down arrow keys to select the new item. Press the ENTER key to accept the change.

Operate Menu (M8)

The Operate Menu provides an easy-to-use method of viewing key numerical Monitoring Menu items. Some applications also support the setting of reference values in this menu. The items displayed vary by application. The table below is an example for the standard application.

Operate Menu Items—Standard Application Example

Code	Signal Name	Unit	Description
0.1	Output frequency	Hz	Output frequency
0.2	Freqreference	Hz	Frequency reference
0.3	Motor speed	rpm	Calculated motor speed
0.4	Motor current	A	Measured motor current
0.5	Motor torque	%	Calculated torque based on nominal motor torque
0.6	Motor power	%	Calculated power based on nominal motor power
0.7	Motor voltage	V	Calculated motor voltage
0.8	DC bus voltage	V	Measured DC bus voltage
0.9	Unit temperature	°C	Heatsink temperature
0.10	Motor temperature	%	Calculated motor temperature based on the motor nameplate information and the calculated motor load
R1	Keypad reference	Hz	Keypad frequency reference setting

The menu is navigated by using the left and right arrow buttons. If a reference level is available for setting, the up and down arrow buttons adjust the value. To exit the Operate Menu to access the other menus, depress the ENTER button for 2 seconds. While in the other menus, if there is no keypad activity, the display will return to the Operate Menu after 30 seconds. The figure below illustrates the Operate Menu button function.

Operate Menu Navigation

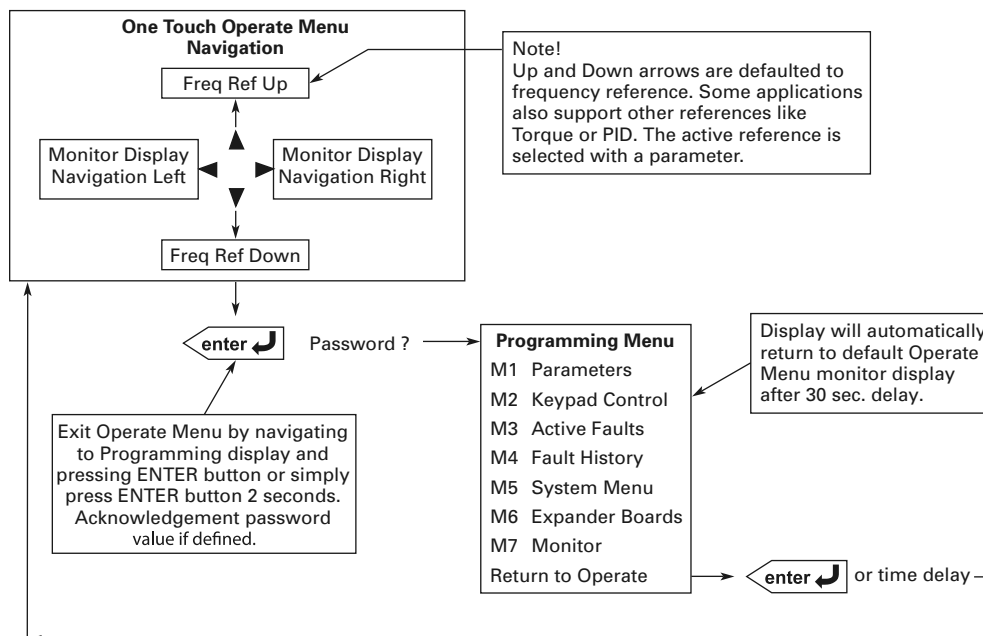

Menu Information

Startup Wizard

Upon initial power up, the **Startup Wizard** guides the commissioner through the basic SVX9000/SPX9000 setup. The **Startup Wizard** may be set to function upon an application change by setting parameter P5.5.3.

Upon power up, the display will read:
"Startup Wizard"
"Press enter"

Upon pressing ENTER, the choice for the language to be used followed by the application desired are presented. The lists are navigated by using the right arrow and up and down arrow buttons. A selection is confirmed by pressing ENTER. After these two selections, the following text appears:
"Setup starts"
"Press enter"

When ENTER is pressed, the setup parameter list is presented. The parameter value will be blinking, allowing you to set the parameters with the arrow buttons. The value is confirmed using the ENTER button, after which the next parameter in the list will be displayed.

After the last setup parameter is presented, the following text is displayed:
"Repeat setup?"
"Press →"

If the left arrow is pressed, the Startup Wizard restarts. If the ENTER button is pressed, the following is displayed:
"Setup done"

After this, the display returns to the default page, normally the Operate Menu.

Startup

Safety Precautions

Before startup, observe the warnings and safety instructions provided throughout this manual.

WARNING

- 1 Internal components and circuit boards (except the isolated I/O terminals) are at utility potential when the SVX9000/SPX9000 is connected to the line. This voltage is extremely dangerous and may cause death or severe injury if you come in contact with it.**
- 2 When the SVX9000/SPX9000 is connected to the utility, the motor connections U (T1), V (T2), W (T3) and DC bus/brake resistor connections B-, B+, and R- are live even if the motor is not running.**
- 3 Do not make any connections when the AF drive is connected to the utility line.**
- 4 Do not open the cover of the AF drive immediately after disconnecting power to the unit, because components within the drive remain at a dangerous voltage potential for some time. Wait at least five minutes after the cooling fan has stopped and the keypad or cover indicators are dark before opening the SVX9000/SPX9000 cover.**
- 5 The control I/O terminals are isolated from the utility potential, but relay outputs and other I/Os may have dangerous external voltages connected even if power is disconnected from the SVX9000/SPX9000.**
- 6 Before connecting to the utility, make sure that the cover of the drive is closed.**

Overview

The SVX9000/SPX9000 control can be used to operate induction motors using the applications included in the system software delivered with the drive. Higher performance permanent magnet (PM) synchronous motors and other functions of the frequency converter (FC) are accomplished by loading special applications with the 9000XLoad software tool. The following sections describe how to commission the drive for motor control in all applications. See the All-in-One or special application manual for additional startup information or details on the parameters. Parameters are available (visible) based on the application selected, the type of control (SVX or SPX), the option boards installed in the control and the version of the system software loaded in the control. In general, the SVX controls are limited to V/Hz and open loop speed control of induction motors while the SPX control will work with any application, and option board. Before starting the commissioning process, select the type of control, option boards, and the size of the drive to meet the needs of the application, and check that the latest system software is loaded. Open loop or sensorless control means that motor control is accomplished by the standard drive unit without added speed/position feedback

devices and associated option cards. Vector control means that the drive can differentiate between torque producing and magnetizing current when reading motor phase currents. The "rotor flux oriented, current vector control" allows the AC drive to control an induction motor in the same manner as a separately excited DC motor.

Open Loop Vector Control Operations

The SVX9000/SPX9000 control normally operates an induction motor in V/Hz or open loop vector control (speed control) mode. By default, the ID run is designed to automatically configure parameters for the programmable volts per hertz (V/f) curve and make a stator resistance measurement for a standard induction motor. If the ID run does not give the proper performance, manual tuning of the control is required and described in later sections.

Frequency Controlled Application

For pumps and fans, the application is usually frequency controlled and there is no need for high torque on low speed. A straight V/f curve ("linear" V/Hz ratio type) is all that is required for proper operation. Because pumps and fans are variable torque, selecting "Squared" for V/Hz ratio type will give some energy savings. Compensation for measured stator resistance voltage drop will improve performance, and selecting "Auto Torque Boost" will help start the motor if necessary. The SLX/SVX controls will operate a PM motor open loop, but manual tuning of the V/f curve is required.

Speed Controlled Application

When an application is speed controlled and high torque at low speed is needed, it is often necessary to complete the ID run; select auto torque boost to help start the motor, and set the drive to speed control mode to compensate for the slip of the induction motor.

Closed Loop Vector Control Operations

Closed loop vector mode provides the best performance for speed and torque control; especially in low speed, high torque applications, including full torque at zero speed. The SPX is required for closed loop control with a speed or position feedback device. The closed loop ID run is similar to the open loop mode ID run.

PM Motor Control Operations

The SPX control can be used to control a synchronous PM motor open loop, or closed loop with a resolver or absolute encoder. Best low speed, high torque performance is achieved with a position feedback device. The high performance multi-purpose application has a selection for PM motor control. The PM motor Encoder ID run determines the zero position of the rotor and stores it to a parameter for use when the load is connected.

Sequence of Operation to Commission an Induction Motor

1. Read and follow all safety warnings and cautions in this manual.
2. At installation, ensure:
 - That the SVX9000/SPX9000 and motor are connected to ground.
 - That the utility and motor cables are in accordance with the installation and connection instructions as detailed starting on **Page 5**.
 - That the control cables are located as far as possible from the power cables as detailed starting on **Page 21**. That control cable shields are connected to protective ground. That no wires make contact with any electrical components in the SVX9000/SPX9000.
 - That the common input of each digital input group is connected to ground or +24V of the I/O terminal supply or an external supply as detailed here.
3. Check the quality of the cooling air as detailed starting on **Page 3**.
4. Check that moisture has not condensed inside the SVX9000/SPX9000.
5. Check that all START/STOP switches connected to the I/O terminals are in the STOP state.
6. Connect the SVX9000/SPX9000 to the utility and switch the power on. For the initial power-up, you will enter the **Startup Wizard**, which will guide you through application selection and basic parameter setup. See the **Startup Wizard** on **Page 46** for more information. After completing the **Startup Wizard**, proceed to step 8. If this is not the initial power-up, the keypad will default to the Operate Menu. Depress the ENTER button for 2 seconds to enter the Parameter Menu. Proceed to step 7.
7. Ensure that the Group 1 parameters match the application by setting, at minimum, the following parameters to match the motor nameplate:
 - Nominal voltage of the motor.
 - Nominal nameplate frequency of the motor.
 - Nominal nameplate full load speed of the motor.
 - Motor nominal current.
 - Motor power factor.
 - Motor type (select PM motor in Group 6 of special app)
8. Perform either Test A or Test B without the motor connected to the SVX9000/SPX9000.
 - Test A**—Control from the Control Panel
 - Apply input power to the SVX9000/SPX9000.
 - Press the keypad START button.
 - If not in the Operate Menu, go to the Monitoring Menu and check that the output frequency follows the keypad reference.
 - Press the keypad STOP button.
 - Test B**—Control from the I/O Terminals
 - Apply input supply power to the SVX9000/SPX9000.
 - Change control from the keypad to the I/O terminals using the LOCAL/REMOTE button.
 - Start the drive by closing the START/STOP input on DIN1.
 - Change the frequency reference setting on AI1.
 - If not in the Operate Menu, go to the Monitoring Menu and check that the output frequency follows the frequency reference.
 - Stop the drive by opening the START/STOP input on DIN1.
9. Disconnect all power to the SVX9000/SPX9000. Wait until the cooling fan on the unit stops and the indicators on the panel are not lit. If no keypad is present, check the indicators in the control panel cover. Wait at least five more minutes for the DC bus to discharge. Connect the motor to the SVX9000/SPX9000. If possible, perform a startup test or ID run with the motor connected to the SVX9000/SPX9000 but not connected to the process. If the SVX9000 must be tested with the motor connected to the process, perform it under no-load conditions.
10. Repeat Test 8A or 8B to check operation of the motor without the process or load. Note proper motor current, voltage, and direction of shaft rotation. If an encoder card is installed, set encoder parameters in the expander board menu and monitor frequency and speed from the encoder board. Frequency should match output frequency of the drive with a positive value for forward direction. If encoder frequency is opposite, change motor phase order, encoder connection, or select “invert” on the expander board menu. For many pump or fan applications, no tuning is required. If further tuning is necessary, perform the tuning while the motor is disconnected from the process.

11. Perform ID Run. Setting the identification parameter to the appropriate value Par/group P1.6.16 followed by a start command within 20 seconds activates automatic identification. (See Test 8A or 8B for start command.) Upon completion, cancellation by a stop command or if timely start is not received, the parameter will reset to its default setting. Possible ID run selections are as follows:
 - OL V/f Ratio—The drive is run at zero speed to identify the motor parameters. (Earlier system software version.)
 - OL V/f +Boost—The drive is run at zero speed to identify the motor parameters and automatic torque boost is turned on. (Earlier system software version.)
 - Identification without motor run—The drive is run at zero speed to identify the motor parameters.
 - Identification with motor run—The drive is run at 2/3 rated speed to identify the motor parameters. (No load on motor.)
 - Encoder ID run—Identifies the shaft zero position when using PM motor with absolute encoder or resolver feedback.
12. When ID Run is complete as shown by a stop indication on the keypad, reset the drive with a stop command according to Test 8A or 8B. Set the motor control mode to OL Speed Control, CL Speed Control if appropriate for the application and repeat Test 8A or 8B.
13. If necessary, skip to the next section to perform manual tuning functions before connecting the motor to the process.
14. Disconnect all power to the SVX9000/SPX9000. Wait until the cooling fan on the unit stops and the indicators on the panel are not lit. If no keypad is present, check the indicators in the control panel cover. Wait at least five more minutes for the DC bus to discharge. Connect the motor to the driven load, making sure mechanical system requirements are met. Make sure that the driven load can be run safely and that no hazard exists to any personnel. Repeat Test 8A or 8B.

Startup

Manual Tuning of the SVX9000/SPX9000

Proper tuning of the open loop speed control will give better torque control accuracy for improved motor performance. The aim of tuning is to get the motor model as close to the actual motor as possible through proper setting of parameters. Open loop tuning consists of three functions, 1) V/f curve tuning, 2) stator resistance measurement, and 3) compensation for slip.

Open Loop Tuning

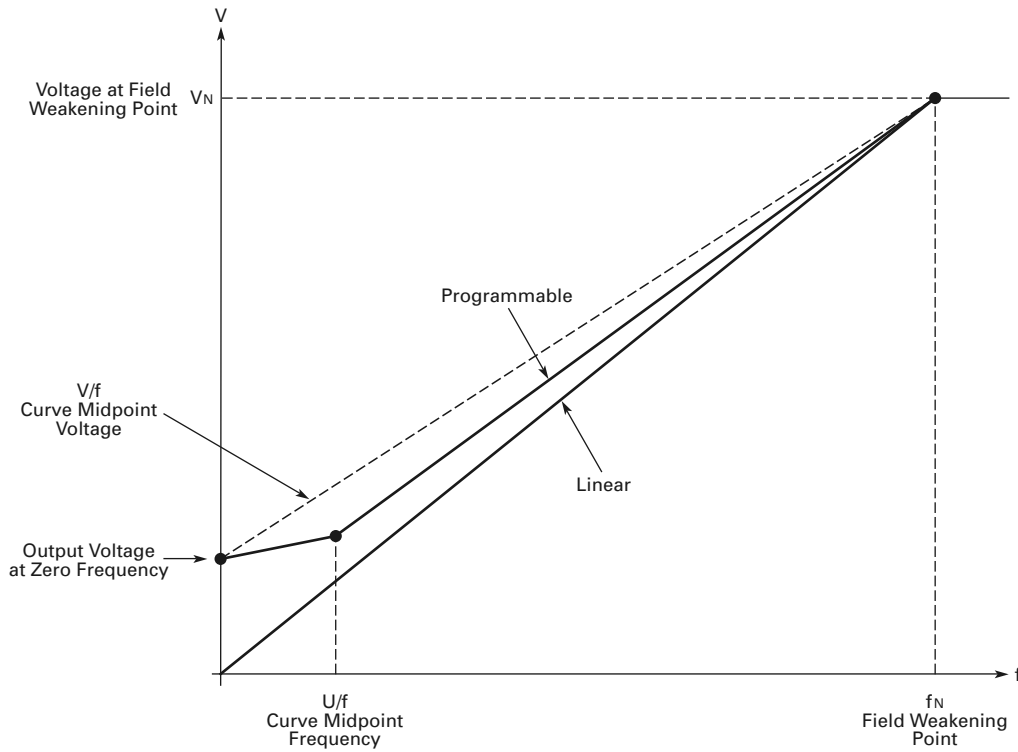

V/f Curve Manual Tuning

When tuning the V/f curve manually (not using identification run) the motor shaft must be unloaded and the motor control mode set to frequency control (P1.6.1). The following parameters are adjusted to tune the V/f curve:

Parameters

V/f ratio selection	P1.6.3
Field weakening point	P1.6.4
Voltage at field weakening point	P1.6.5
V/f curve midpoint frequency	P1.6.6
V/f curve midpoint voltage	P1.6.7
Output voltage at zero frequency	P1.6.8

When using a linear V/f curve with increased zero frequency voltage, ensure that the motor current does not increase too much between 3–7 Hz.

Tuning Steps

Set the motor nameplate values.

Nominal voltage of motor	P1.1.6
Nominal frequency of motor	P1.1.7
Nominal speed of motor	P1.1.8
Nominal current of motor	P1.1.9
Motor Power Factor (Cos Phi)	P1.1.10

Run the motor unloaded at 2/3 rated speed using a frequency reference. Read the motor current from the monitoring menu (V7.4) or use 9000X drive for monitoring. This current is the motor magnetizing current. This value should match a nameplate magnetizing current value if given.

If the motor will only be run in closed loop, skip to section on closed loop vector control tuning.

Change the V/f curve ratio selection to programmable-mode = 2 (P1.6.3).

Run motor with zero frequency reference and increase motor zero point voltage (P1.6.8) until motor current is approximately the same as the motor magnetizing current. (If motor is only in the low frequency area for short periods, it is possible to use up to 80% of rated current.)

Then, set the midpoint voltage (P1.6.7) to $1.4142 * P1.6.8 (\sqrt{2} * \text{Zero Point Voltage})$ and midpoint frequency (P1.6.6) to value $P1.6.8/100\% * P1.1.7$. ($[\text{ZeroPoint Voltage}/100\%] * \text{Nominal frequency of motor.}$)

$$P1.6.7 = \sqrt{2} * P1.6.8 \quad P1.6.6 = \frac{P1.6.8}{100} * P1.1.7$$

Startup

Hint for the 9000X Drive User:

When zero point voltage is set correctly, run motor with slow ramp (~20s) to 1/2 of rated frequency. Show output frequency and motor current in the 9000X drive monitoring window. If midpoint parameters are set correctly, motor current should be stable during acceleration. (heavy solid line in figure below).

If there is a peak in the monitored motor current (heavy dashed line in figure below), check what the output frequency is at the maximum current point, and set this value for midpoint frequency (P1.6.6). Then readjust midpoint voltage for a stable current performance during acceleration.

Motor Current after V/f Curve Tuning

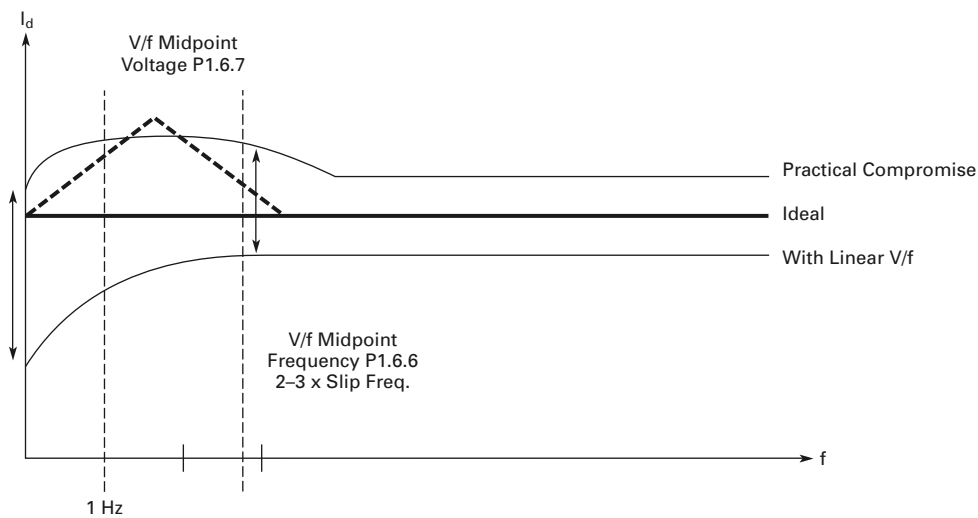

Stator Resistance Measurement Using DC Brake at Start

1. Define the DC brake current (=motor nominal current) (P1.4.8).
2. Set the DC brake time at start to 2 seconds (P1.4.11).
3. Give start command.

The drive will correct the stator impedance to improve the motor torque calculation. This also improves slip compensation accuracy. (Stator resistance voltage loss compensation, see figure below.)

If the DC brake time at start is set back to zero, the calculated stator impedance value goes back to default if the drive's power is switched off. (Identification will retain all values in memory.)

Motor Current Equivalent Circuit

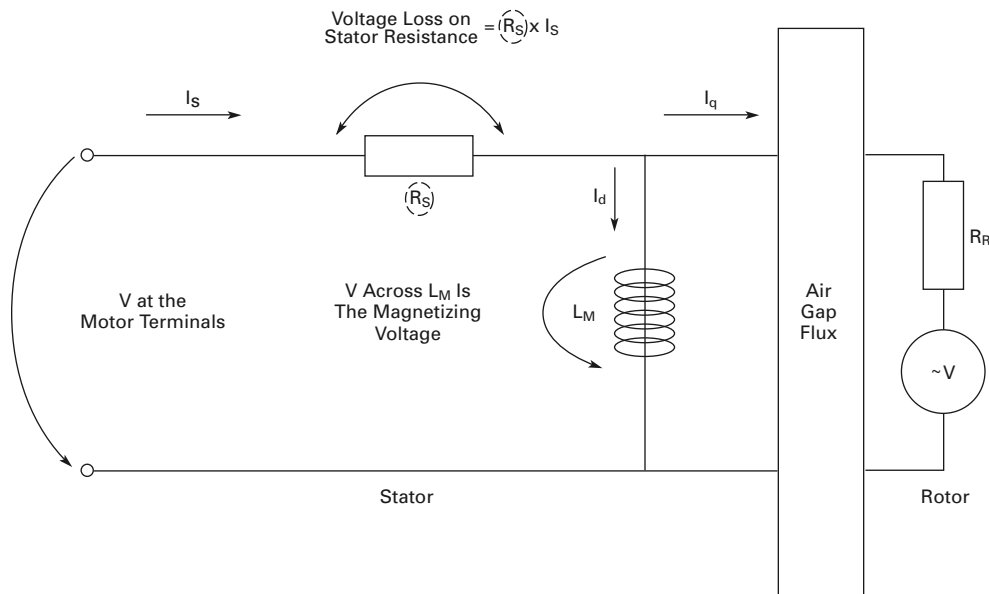

Change the motor control mode to the speed control (P1.6.1 = 1).

Change the V/f optimization (auto torque boost) to on if more torque is needed on low frequencies (P1.6.2). Note, this will increase motor voltage while loading motor, check motor current draw.

Note: In high torque–low speed applications it is likely that the motor will overheat. If the motor has to run a prolonged time under these conditions, special attention must be paid to cooling the motor.

Startup

Slip Compensation in Open Loop

The drive uses motor torque and motor nominal RPM to compensate slip. If motor nominal RPM is 1710 -> nominal slip is 90 RPM, and when motor torque is 50% slip is 45 RPM. To keep reference, speed drive must increase output frequency by:

$$\frac{50\% * 90 \text{ RPM}}{1800 \text{ RPM}} * 60.00 \text{ Hz} = 1.50 \text{ Hz}$$

OL Speed Control Off

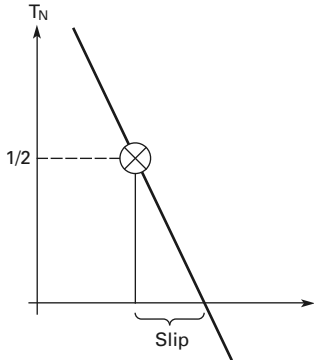

OL Speed Control On

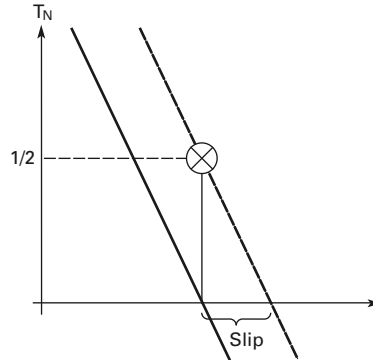

Closed Loop Vector Control Manual Tuning (SPX9000 Only)

For some non-standard motors, the auto-tune is not sufficient. Closed loop control mode is used when enhanced performance near zero speed and better steady starts and dynamic speed accuracy at higher speeds are needed.

Tuning Steps

Set the motor nameplate values.

Nominal voltage of motor	P1.1.6
Nominal frequency of motor	P1.1.7
Nominal speed of motor	P1.1.8
Nominal current of motor	P1.1.9
Motor Power Factor (Cos Phi)	P1.1.10

Check encoder pulse/revolution rate and set this value to expander menu P6.3.1.1. Parameter is only visible if OPTA4 or OPTA5 is installed to slot C.

Set motor control mode to open loop frequency control (P1.6.1 = 0).

Run the motor unloaded at 2/3 rated speed using a frequency reference. Read the motor current from the monitoring menu (V1.4) or use 9000X drive for monitoring. This current is the motor magnetizing current. This value should match a nameplate magnetizing current value if given.

Set the motor magnetizing current P1.6.17.1.

Check the expander board menu (monitoring page V6.3.2.1), to be sure that the encoder frequency is approximately the same as the output frequency, and that the direction is correct. If the encoder frequency direction is opposite the output frequency (negative value), change the motor phase order to encoder connection. The expander board menu also has a parameter to invert the signal if rewiring is not an option.

Set motor control mode to closed loop (P1.6.1 = 3 or 4).

Fine Tuning

Tune parameter P1.6.17.6 (slip adjust) to get the motor voltage slightly above the linear V/f curve when motor is loaded and slightly below when motor is generating.

Using the linear V/f curve (P1.6.3 = 0), run the motor in frequency control mode (P1.6.1 = 0) at about 2/3 of the motor nominal frequency and check motor voltage (V7.7).

At 40 Hz, voltage should be $40/60 * 460V = 307V$.

Run the motor in closed loop control mode with same reference and check the motor voltage. Adjust P1.6.17.6 (slip adjust) so that motor voltage is slightly above the linear V/f curve. If motor voltage is low, decrease the value of slip adjust (P1.6.17.6).

Closed Loop Motor Voltage

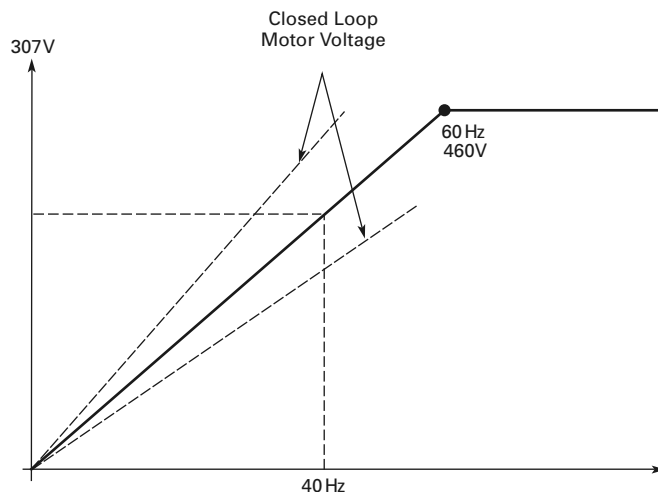

Fine Tuning Parameters

Adjust the following parameters for optimum performance in closed loop mode:

613 Speed Control P Gain

Sets the gain for the speed controller in % per Hz. 100 means nominal torque with 1 Hz frequency error.

614 Speed Control I Time

Sets the integral time constant for the speed controller. Too short integration time makes the control unstable.

620 Load Drooping

Setting a proper value to the LoadDrooping parameter enables the load drooping. This function causes the speed to decrease as the load torque increases. At rapid load changes, this gives a smoother torque response, when a part of the required power is taken from the system inertia. This operation causes a constant, torque-dependent steady-state error in speed response.

626 Acceleration Compensation

Sets the inertia compensation to improve speed response during acceleration and deceleration. The time is defined as acceleration time to nominal speed with nominal torque. This parameter is active also in advanced open loop mode.

627 Magnetizing Current at Start

628 Magnetizing Time at Start

These parameters are certain type of DC brake in start. With these parameters it is possible to shorten the time needed to fully magnetize the motor, especially when motor is big.

615 Zero Speed Time at Start

After giving the start command, the drive will remain at zero speed for the time defined by this parameter. The ramp is released to follow the set frequency/speed reference after this time has elapsed.

616 Zero Speed Time at Stop

The drive will remain at zero speed with controllers active for the time defined by this parameter after reaching the zero speed when a stop command is given. This parameter has no effect if the selected stop function (P1.4.7) is coasting.

621 Startup Torque

This parameter selects the startup torque.

Torque memory is used in crane applications. Startup torque FWD/REV can be used in other applications to help the speed controller.

- 0 = Not Used
 - 1 = TorqMemory
 - 2 = Torque Ref
 - 3 = Torq.Fwd/Rev
-

633 Startup Torque, Forward

Sets the startup torque for forward direction, if selected with par. 1.6.17.12.

634 Startup Torque, Reverse

Sets the startup torque for reverse direction, if selected with par. 1.6.17.13.

107 Current Limit

This parameter determines the maximum motor current from the frequency converter. The parameter value range differs from size to size. On closed loop control mode, this limits torque (= torque producing current).

For example, if motor magnetizing current is 2.0A and current limit is 1.0A, total motor current can be:

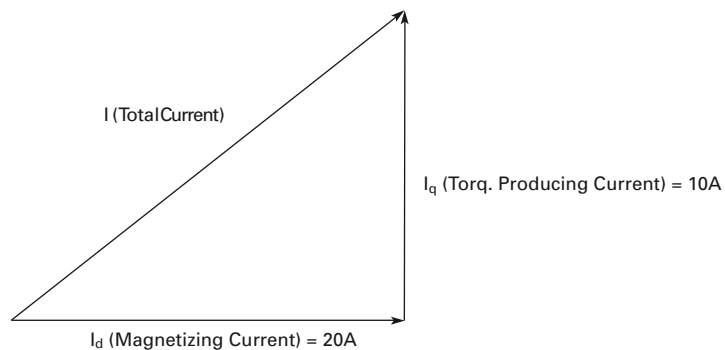
Closed Loop Current Limit

$$I^2 = I_d^2 + I_q^2$$

$$I = \sqrt{I_d^2 + I_q^2} \rightarrow I = 2.24A$$

Technical Data

General

The figure below shows a block diagram of the SVX9000/SPX9000 drive. The SVX9000/SPX9000 physically consists of two sections, the power unit and the control unit. The three-phase **AC Choke** with the **DC Link Capacitor** form a LC filter, which together with the **Rectifier** produce the DC voltage for the **IGBT Inverter** block. The **AC Choke** smooths the disturbances from the utility into the SVX9000/SPX9000 as well as the high frequency disturbances caused by the SVX9000/SPX9000 on the utility line. It also improves the input current waveform to the SVX9000/SPX9000. The **IGBT Inverter** produces a symmetrical three-phase pulse width modulated adjustable frequency AC voltage to the motor.

The **Motor and Application Control** block contains a microprocessor with customized software. The microprocessor controls the motor based on **Measured Signals**, parameter value settings, and commands from the **Control I/O Block** and the **Control Module**. The **Motor and Application Control** block commands the **Motor Control ASIC** which calculates the IGBT switching positions. **Gate Drivers** amplify these signals for driving the **IGBT Inverter**.

The **Control Keypad** is a link between the user and the SVX9000/SPX9000. With the **Control Keypad**, the user can set parameter values, read status information, and issue control commands. The **Control Keypad** is removable and can be mounted externally and connected with the appropriate cable. Instead of the **Control Keypad**, a PC can be used to control the SVX9000/SPX9000 by cable connecting it where the **Control Keypad** is normally connected or through an option board.

The **Control I/O Block** is isolated from line potential and may be connected to or isolated from ground by the choice of the control I/O board that is used. OPTA8 is isolated ground, OPTA1 and OPTA9 are not.

Input and Output EMC-Filters are not required for the functionality of the SVX9000/SPX9000. They are only needed for compliance with the EU EMC directive as detailed in the following section.

SVX9000/SPX9000 Block Diagram

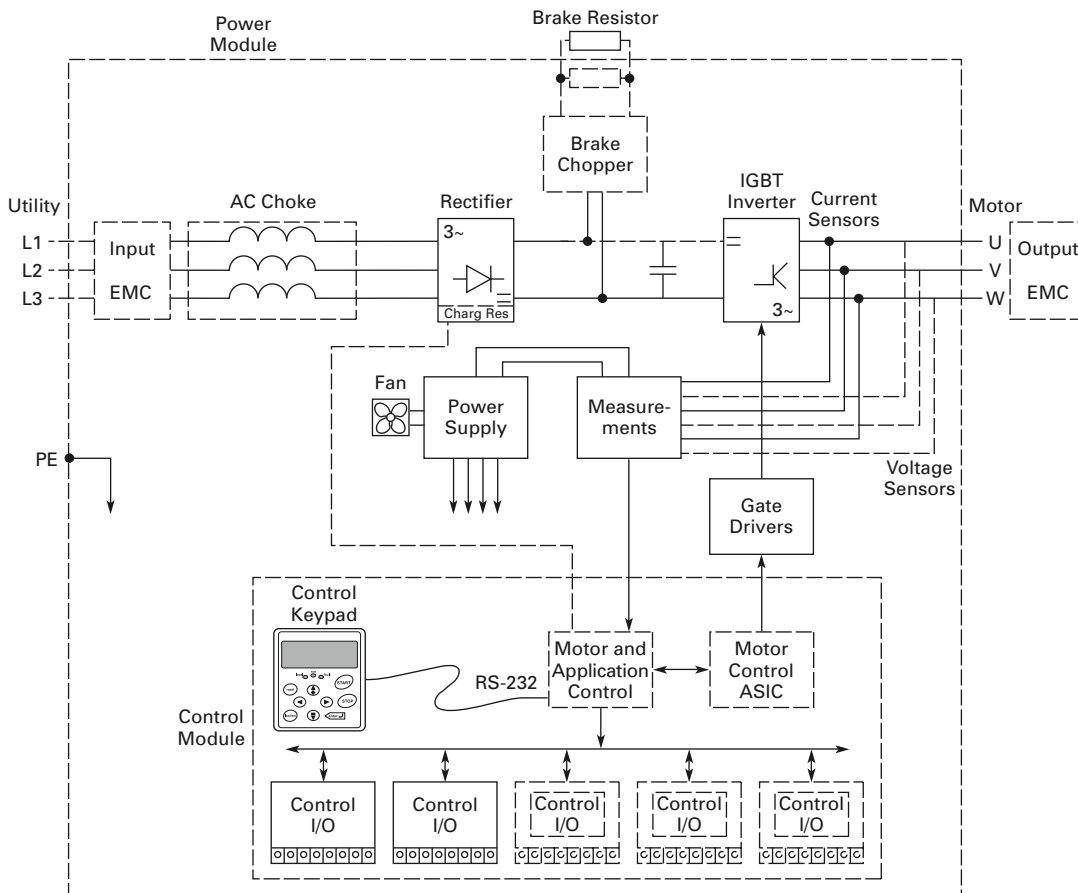

Specifications

SVX9000/SPX9000 Drive Specifications

Description	Specification
Power Connections	
Input voltage (V_{in})	208–240V +10%/–15%
	380–500V +10%/–15%
	525–690V +10%/–15%
Input frequency (f_{in})	50/60 Hz (variation up to 45–66 Hz)
Connection to utility power	Once per minute or less (typical operation)
Maximum symmetrical supply current	208–240V, 100 kAIC
	380–500V, 100 kAIC
	525–690V, 100 kAIC
Motor Connections	
Output voltage	0 to V_{in}
Continuous output current	Ambient temperature max. 122°F (50°C), overload 1.5 x I_H (1 min. out of 10 min.)
Starting current	200% for 2 seconds
Output frequency	0 to 320 Hz standard (optional frequencies available)
Frequency resolution	0.01 Hz
Control Characteristics	
Control method	SVX frequency control (V/f)
	SVX open loop sensorless vector
	SPX open loop sensorless vector control
	SPX closed loop control
Switching frequency	Adjustable with parameter 2.6.9
	208–230V: 3/4–15 hp: 1 to 16 kHz; 20–30 hp: 1 to 6 kHz
	380–500V: 1–30 hp: 1 to 16 kHz; 40–200 hp: 1 to 6 kHz
	525–690V: All sizes: 1 to 6 kHz
Frequency reference	Analog input: resolution 0.1% (10-bit), accuracy $\pm 1\%$
	Panel reference: resolution 0.01 Hz
Field weakening point	30 to 320 Hz
Acceleration time	0.1 to 3000 sec.
Deceleration time	0.1 to 3000 sec.
Braking torque	DC brake: 15% to 150% x T_n (without brake option)
Environment	
Ambient operating temperature	14°F (–10°C), no frost to 122°F (50°C) I_H
	14°F (–10°C), no frost to 104°F (40°C) I_L
Storage temperature	–40°F (–40°C) to 158°F (70°C)
Relative humidity	0 to 95% RH, noncondensing, noncorrosive, no dripping water
Air quality	Chemical vapors: IEC 60721-3-3, unit in operation, Class 3C2
	Mechanical particles: IEC 60721-3-3, unit in operation, Class 3S2
Altitude	100% load capacity (no derating) up to 3300 ft (1000m); 1% derating for each 330 ft (100m) above 3300 ft (1000m); max. 10,000 ft (3000m)

SVX9000/SPX9000 Drive Specifications, continued

Description	Specification
Environment, continued	
Vibration	EN 50178, EN 60068-2-6 5 to 50 Hz, displacement amplitude 1 mm (peak) at 3 to 15.8 Hz, max. acceleration amplitude 1G at 15.8 to 150 Hz
Shock	EN 50178, EN 60068-2-27 UPS drop test (for applicable UPS weights) Storage and shipping: max. 15G, 11 ms (in package)
Enclosure class	NEMA 1/IP21 available all ratings NEMA 12/IP54 available all ratings
Standards	
EMC (at default settings)	Immunity: Fulfills all EMC immunity requirements Emissions: EN 61800-3
Safety	UL 508C
Product	IEC 61800-2
Control Connections	
Analog input voltage	0 to 10 Vdc, R–200k ohms differential (–10 to 10 Vdc joystick control) Resolution 0.1%; accuracy ±1%
Analog input current	0(4) to 20 mA; R _i –250 ohms differential
Digital inputs (6)	Positive or negative logic; 18 to 24 Vdc
Auxiliary voltage	+24V ±15%, max. 250 mA
Output reference voltage	+10V +3%, max. load 10 mA
Analog output	0(4) to 20 mA; R _L max. 500 ohms Resolution 10 bit Accuracy ±2% or 0 to 10 Vdc, R _L 1k ohms, select with jumper
Digital output	Open collector output, 50 mA/48V
Relay output	3 programmable change-over relay outputs Switching capacity: 24 Vdc/8A, 250 Vac/8A, 125 Vdc/0.4A Minimum switching load: 5V/10 mA Continuous capacity: <2 A _{rms}
Protections	
Overcurrent protection	Yes
Undervoltage protection	Yes
Ground (earth) fault	In case of a ground fault in the motor or motor cables, only the SVX9000/SPX9000 is protected
Input phase supervision	Trips if any of the input phases are missing
Motor phase supervision	Trips if any of the output phases are missing
Overtemperature protection	Yes
Motor overload protection	Yes
Motor stall protection	Yes
Motor underload protection	Yes
Short circuit protection of the +24V and +10V reference voltages	Yes

SVX9000/SPX9000 Series Drives

**208–240V Power Ratings—NEMA Type 1/IP21 or NEMA Type 12/IP54
230V/60 Hz Three-Phase Input**

Frame Size	hp (I _H)	kW (I _H)	Current (I _H)	hp (I _L)	kW (I _L)	Current (I _L)	Switching Frequency			Heat Losses	Catalog Number
	Horsepower	Open Drive kW	High Overload Full Load Amps at 40°C	Horsepower	Open Drive kW	Low Overload Full Load Amps at 40°C	Min	Max	Default	Watts at Rated Output and Default SF	Values for “x” 1 = N1 = IP21 2 = N12 = IP54
FR4	3/4	0.55	3.7	1	0.75	4.8	1	16	10	19	SVXF07Ax-2A1B1
	1	0.75	4.8	1-1/2	1.1	6.6	1	16	10	28	SVX001Ax-2A1B1
	1-1/2	1.1	6.6	2	1.5	7.8	1	16	10	38	SVXF15Ax-2A1B1
	2	1.5	7.8	3	2.2	11	1	16	10	55	SVX002Ax-2A1B1
	3	2.2	11	—	3	12.5	1	16	10	75	SVX003Ax-2A1B1
FR5	—	3	12.5	5	4	17.5	1	16	10	100	SVX004Ax-2A1B1
	5	4	17.5	7-1/2	5.5	25	1	16	10	138	SVX005Ax-2A1B1
	7-1/2	5.5	25	10	7.5	31	1	16	10	188	SVX007Ax-2A1B1
FR6	10	7.5	31	15	11	48	1	16	10	275	SVX010Ax-2A1B1
	15	11	48	20	15	61	1	16	10	375	SVX015Ax-2A1B1
FR7	20	15	61	25	18.5	75	1	6	3.6	463	SVX020Ax-2A1N1
	25	18.5	75	30	22	88	1	6	3.6	550	SVX025Ax-2A1N1
	30	22	88	40	30	114	1	6	3.6	750	SVX030Ax-2A1N1
FR8	40	30	114	50	37	140	1	6	3.6	925	SVX040Ax-2A1N1
	50	37	140	60	45	170	1	6	3.6	1125	SVX050Ax-2A1N1
	60	45	170	75	55	205	1	6	3.6	1375	SVX060Ax-2A1N1
FR9	75	55	205	100	75	261	1	6	3.6	1875	SVX075Ax-2A1N1
	100	75	261	125	90	300	1	6	3.6	2250	SVX100Ax-2A1N1

Technical Data

380–500V Power Ratings—NEMA Type 1/IP21 or NEMA Type 12/IP54 480V/60 Hz Three-Phase Input

Frame Size	hp (I _H)	kW (I _H)	Current (I _H)	hp (I _L)	kW (I _L)	Current (I _L)	Switching Frequency			Heat Losses	Catalog Number
	Horsepower	Open Drive kW	High Overload Full Load Amps at 40°C	Horsepower	Open Drive kW	Low Overload Full Load Amps at 40°C	Min	Max	Default	Watts at Rated Output and Default SF	Values for "x" 1 = N1 = IP21 2 = N12 = IP54 0 = Open
FR4	1	0.75	2.2	1-1/2	1.1	3.3	1	16	10	28	SVX001Ax-4A1B1
	1-1/2	1.1	3.3	2	1.5	4.3	1	16	10	38	SVXF15Ax-4A1B1
	2	1.5	4.3	3	2.2	5.6	1	16	10	55	SVX002Ax-4A1B1
	3	2.2	5.6	5	3	7.6	1	16	10	75	SVX003Ax-4A1B1
	5	3	7.6	—	5.5	9	1	16	10	138	SVX005Ax-4A1B1
	—	4	9	7-1/2	5.5	12	1	16	10	138	SVX006Ax-4A1B1
FR5	7-1/2	5.5	12	10	7.5	16	1	16	10	188	SVX007Ax-4A1B1
	10	7.5	16	15	11	23	1	16	10	275	SVX010Ax-4A1B1
	15	11	23	20	15	31	1	16	10	375	SVX015Ax-4A1B1
FR6	20	15	31	25	18.5	38	1	16	10	463	SVX020Ax-4A1B1
	25	18.5	38	30	22	46	1	16	10	550	SVX025Ax-4A1B1
	30	22	46	40	30	61	1	16	10	750	SVX030Ax-4A1B1
FR7	40	30	61	50	37	72	1	6	3.6	925	SVX040Ax-4A1N1
	50	37	72	60	45	87	1	6	3.6	1125	SVX050Ax-4A1N1
	60	45	87	75	55	105	1	6	3.6	1375	SVX060Ax-4A1N1
FR8	75	55	105	100	75	140	1	6	3.6	1875	SVX075Ax-4A1N1
	100	75	140	125	90	170	1	6	3.6	2250	SVX100Ax-4A1N1
	125	90	170	150	110	205	1	6	3.6	2750	SVX125Ax-4A1N1
FR9	150	110	205	200	132	261	1	6	3.6	3300	SVX150Ax-4A1N1
	200	132	245	250	160	300	1	6	3.6	4000	SVX200Ax-4A1N1
FR10	250	160	300	300	200	385	1	6	3.6	5000	SPX250A0-4A2N1
	300	200	385	350	250	460	1	6	3.6	6250	SPX300A0-4A2N1
	350	250	460	400	250	520	1	6	3.6	6250	SPX350A0-4A2N1
FR11	400	250	520	500	315	590	1	6	3.6	7875	SPX400A0-4A2N1
	500	315	590	—	355	650	1	6	3.6	8875	SPX500A0-4A2N1
	—	355	650	600	400	730	1	6	3.6	10,000	SPX550A0-4A2N1
FR12	600	400	730	—	450	820	1	6	3.6	11,250	SPX600A0-4A2N1
	—	450	820	700	500	920	1	6	3.6	12,500	SPX650A0-4A2N1
	700	500	920	800	560	1030	1	6	3.6	14,000	SPX700A0-4A2N1
FR13	800	560	1030	900	630	1150	1	6	3.6	15,750	SPX800A0-4A2N1
	900	630	1150	1000	710	1300	1	6	3.6	17,750	SPX900A0-4A2N1
	1000	710	1300	1200	800	1450	1	6	3.6	20,000	SPXH10A0-4A2N1
FR14	1200	900	1600	1500	1000	1770	1	6	3.6	25,000	SPXH12A0-4A2N1
	1600	1100	1940	1800	1200	2150	1	6	3.6	30,000	SPXH16A0-4A2N1
	1900	1300	2300	2200	1400	2700	1	6	3.6	35,000	SPXH19A0-4A2N1

525–690V Power Ratings—NEMA Type 1/IP21 or NEMA Type 12/IP54

575V/60 Hz Three-Phase Input

Frame Size	hp (I _H)	kW (I _H)	Current (I _H)	hp (I _L)	kW (I _L)	Current (I _L)	Switching Frequency			Heat Losses	Catalog Number
	Horsepower	Open Drive kW	High Overload Full Load Amps at 40°C	Horsepower	Open Drive kW	Low Overload Full Load Amps at 40°C	Min	Max	Default	Watts at Rated Output and Default SF	Values for “x” 1 = N1 = IP21 2 = N12 = IP54 0 = Open
FR6	2	2.2	3.33	3	3	4.5	1	6	1.5	75	SVX002Ax-5A4N1
	3	3	4.5	—	4	5.5	1	6	1.5	100	SVX003Ax-5A4N1
	—	4	5.5	5	5.5	7.5	1	6	1.5	138	SVX004Ax-5A4N1
	5	5.5	7.5	7-1/2	7.5	10	1	6	1.5	188	SVX005Ax-5A4N1
	7-1/2	7.5	10	10	11	13.5	1	6	1.5	275	SVX007Ax-5A4N1
	10	11	13.5	15	15	18	1	6	1.5	375	SVX010Ax-5A4N1
	15	15	18	20	18.5	22	1	6	1.5	463	SVX015Ax-5A4N1
	20	18.5	22	25	22	27	1	6	1.5	550	SVX020Ax-5A4N1
FR7	25	22	27	30	30	34	1	6	1.5	750	SVX025Ax-5A4N1
	30	30	34	40	37	41	1	6	1.5	925	SVX030Ax-5A4N1
FR8	40	37	41	50	45	52	1	6	1.5	1125	SVX040Ax-5A4N1
	50	45	52	60	55	62	1	6	1.5	1375	SVX050Ax-5A4N1
FR9	60	55	62	75	75	80	1	6	1.5	1875	SVX060Ax-5A4N1
	75	75	80	100	90	100	1	6	1.5	2250	SVX075Ax-5A4N1
	100	90	100	125	110	125	1	6	1.5	2750	SVX100Ax-5A4N1
FR10	125	110	125	150	132	144	1	6	1.5	3300	SVX125Ax-5A4N1
	150	132	144	—	160	170	1	6	1.5	4000	SVX150Ax-5A4N1
	—	160	170	200	200	208	1	6	1.5	5000	SVX175Ax-5A4N1
	200	200	208	250	250	261	1	6	1.5	6250	SPX200A0-5A2N1
FR11	250	250	261	300	315	325	1	6	1.5	7875	SPX250A0-5A2N1
	300	315	325	400	355	385	1	6	1.5	8875	SPX300A0-5A2N1
	400	355	385	450	450	460	1	6	1.5	11,250	SPX400A0-5A2N1
FR12	450	450	460	500	500	502	1	6	1.5	12,500	SPX450A0-5A2N1
	500	500	502	—	560	590	1	6	1.5	14,000	SPX500A0-5A2N1
	—	560	590	600	630	650	1	6	1.5	15,750	SPX550A0-5A2N1
FR13	600	630	650	700	710	750	1	6	1.5	17,750	SPX600A0-5A2N1
	700	710	750	800	800	820	1	6	1.5	20,000	SPX700A0-5A2N1
	800	800	820	900	900	920	1	6	1.5	22,500	SPX800A0-5A2N1
FR14	900	900	920	1000	1000	1030	1	6	1.5	25,000	SPX900A0-5A2N1
	1000	1000	1030	1250	1150	1180	1	6	1.5	28,750	SPXH10A0-5A2N1
	1350	1300	1300	1500	1500	1500	1	6	1.5	37,500	SPXH13A0-5A2N1
FR14	1500	1500	1500	2000	1800	1900	1	6	1.5	45,000	SPXH15A0-5A2N1
	2000	1800	1900	2300	2000	2250	1	6	1.5	50,000	SPXH20A0-5A2N1

Technical Data

Dimensions

Approximate Dimensions in Inches (mm)

NEMA Type 1 and Type 12 Enclosure Dimensions

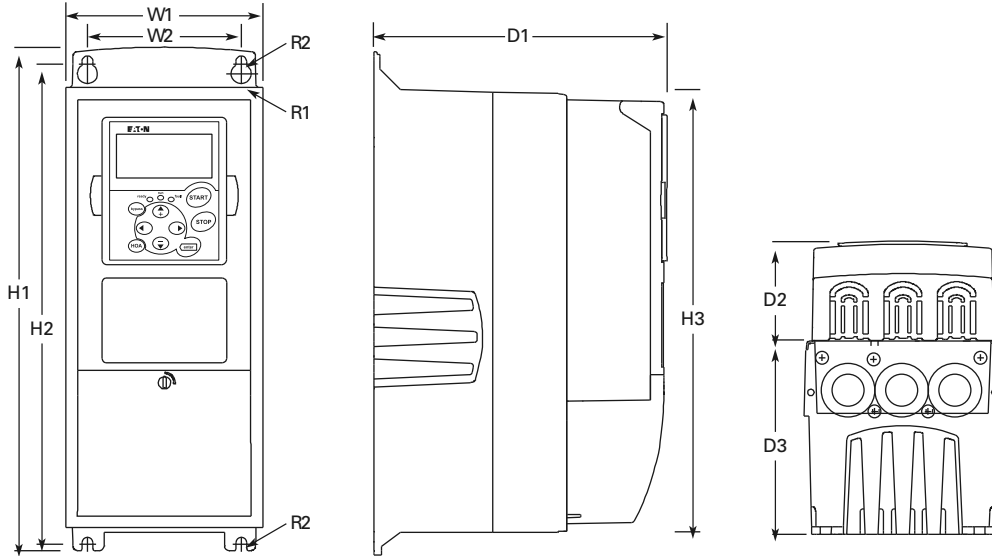

Frame Size	Voltage	hp (I _H)	H1	H2	H3	D1	D2	D3	W1	W2	R1 Dia.	R2 Dia.	Weight Lbs (kg)
FR4	230V	3/4–3	12.9	12.3	11.5	7.5	2.5	5.0	5.0	3.9	0.5	0.3	11 (5)
	480V	1–5	(327)	(312)	(292)	(190)	(64)	(126)	(128)	(100)	(13)	(7)	
FR5	230V	5–7-1/2	16.5	16.0	15.3	8.4	2.7	5.8	5.6	3.9	0.5	0.3	17.9 (8.1)
	480V	7-1/2–15	(419)	(406)	(389)	(214)	(68)	(148)	(143)	(100)	(13)	(7)	
FR6	230V	10–15	22.0	21.3	20.4	9.3	2.7	6.7	7.7	5.8	0.7	0.4	40.8 (18.5)
	480V	20–30	(558)	(541)	(519)	(237)	(68)	(171)	(195)	(148)	(18)	(9)	
	575V	2–25											
FR7	230V	20–30	24.8	24.2	23.3	10.1	2.7	7.5	9.3	7.5	0.7	0.4	77.2 (35)
	480V	40–60	(630)	(614)	(591)	(257)	(68)	(189)	(237)	(190)	(18)	(9)	
	575V	30–40											
FR8	480V	75–125	29.7	28.8	28.4	12.3	1.3	11.0	11.2	10.0	0.7	0.4	127.8 (58)
	575V	50–75	(755)	(732)	(721)	(312)	(34)	(279)	(285)	(255)	(18)	(9)	
FR9	480V	150–200	45.3	44.1	45.3	14.3	5.4	8.8	18.9	15.7	0.7	0.4	321.9 (146)
	575V	100–150	(1150)	(1120)	(1150)	(362)	(137)	(224)	(480)	(400)	(18)	(9)	

Approximate Dimensions in Inches (mm)

NEMA Type 1 and Type 12 with Flange Kit, FR4, FR5, and FR6 Enclosure Dimensions

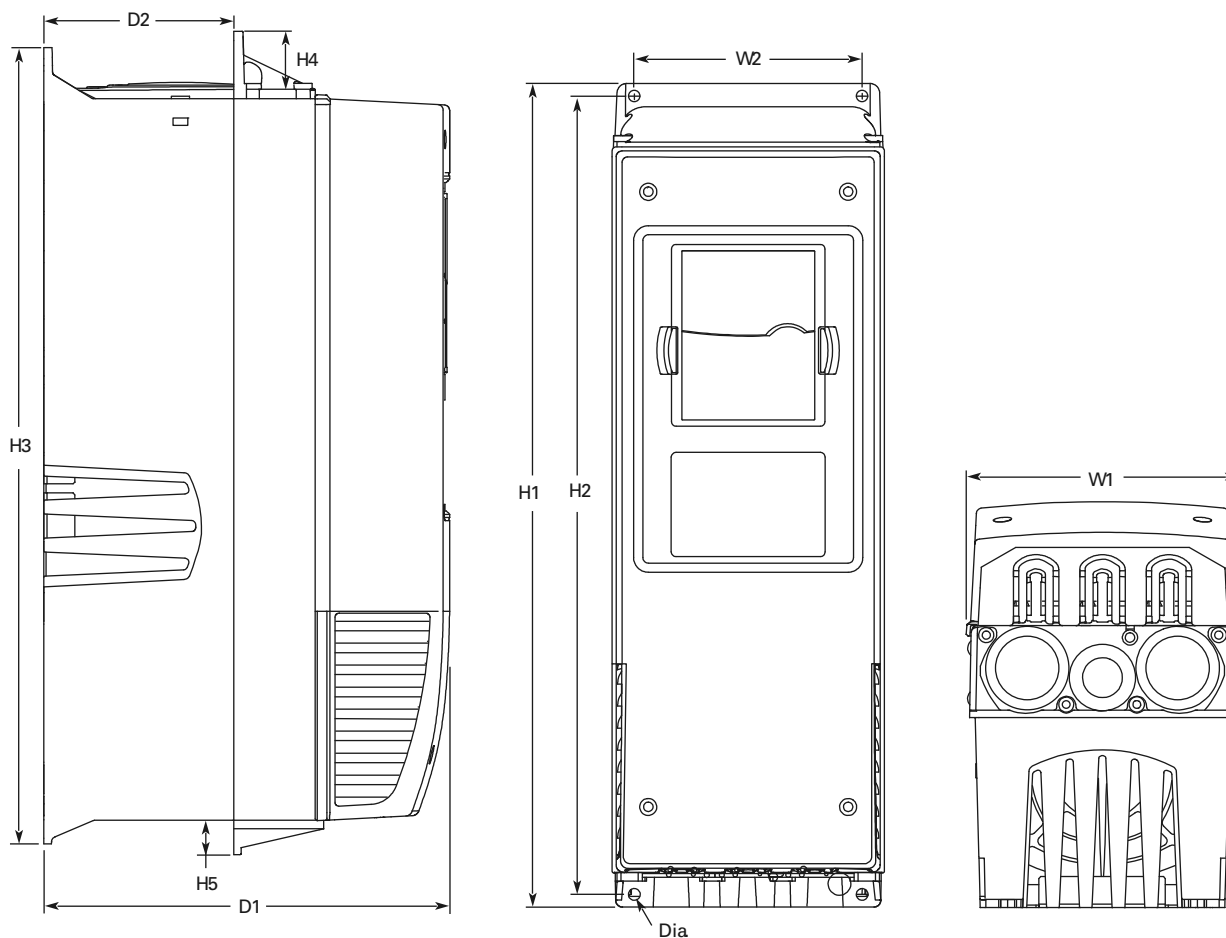

Frame Size	Voltage	W1	W2	H1	H2	H3	H4	H5	D1	D2	Dia.
FR4	230V	5.0	4.45	13.27	12.8	12.9	1.18	0.87	7.5	3.0	0.27
	480V	(128)	(113)	(337)	(325)	(327)	(30)	(22)	(190)	(77)	(7)
FR5	230V	5.67	4.7	17.0	16.5	16.5	1.4	0.7	8.42	3.93	0.27
	480V	(144)	(120)	(434)	(420)	(419)	(36)	(18)	(214)	(100)	(7)
FR6	230V	7.67	6.7	22.0	21.6	21.9	1.18	0.79	9.33	4.17	0.25
	480V	(195)	(170)	(560)	(549)	(558)	(30)	(20)	(237)	(106)	(6.5)
	575V										

Technical Data

Approximate Dimensions in Inches (mm)

NEMA Type 1 with Flange Kit, FR7, and FR8 Enclosure Dimensions

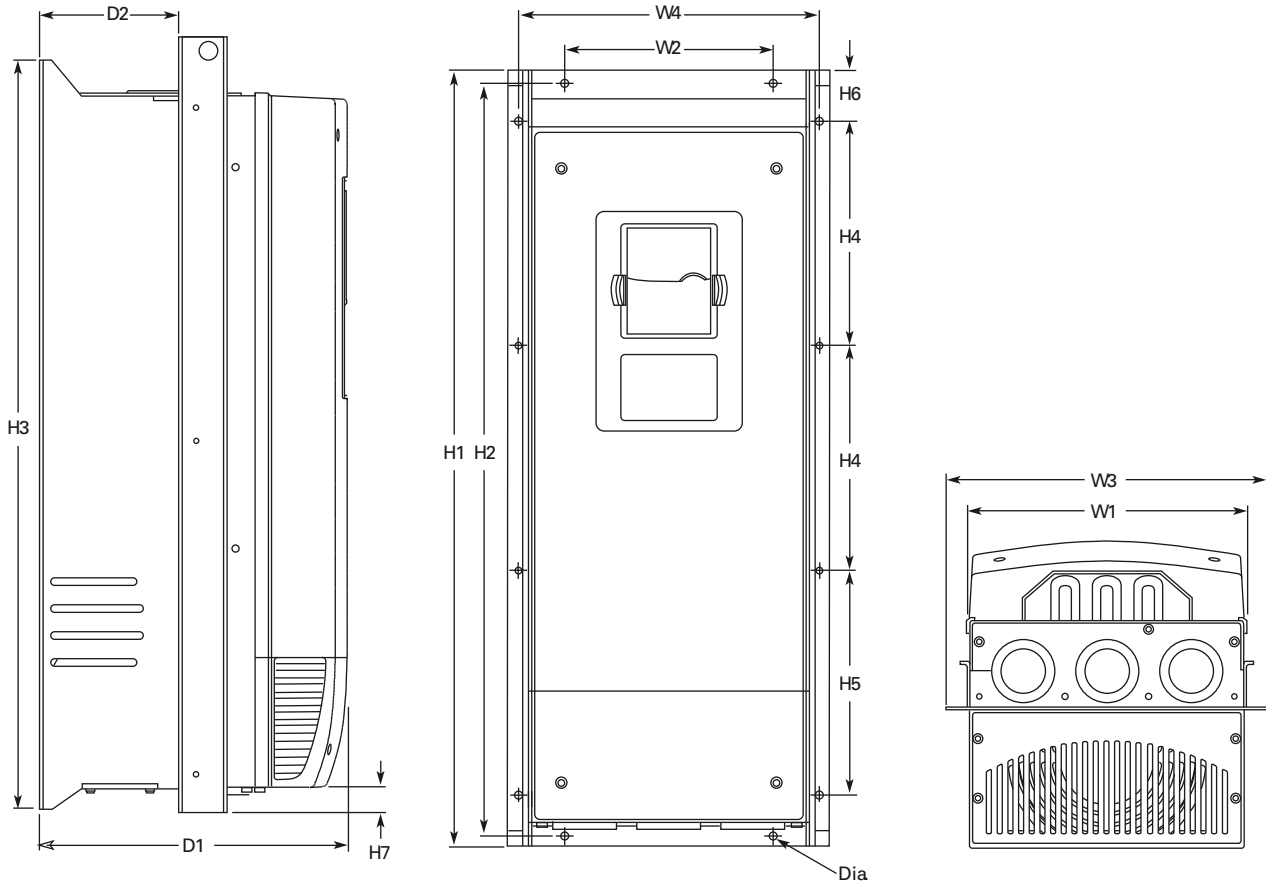

Frame Size	Voltage	W1	W2	W3	W4	H1	H2	H3	H4	H5	H6	H7	D1	D2	Dia.
FR7	230V	9.33	6.8	10.62	10	25.6	24.8	24.8	7.42	7.42	0.9	0.78	10.1	4.6	0.25
	480V	(237)	(175)	(270)	(253)	(652)	(632)	(630)	(188.5)	(188.5)	(23)	(20)	(257)	(117)	(5.5)
	575V														
FR8	480V	11.22	—	13.97	13	32.75	—	29.33	10.15	10.43	1.7	2.24	11.3	4.33	0.35
	575V	(285)		(355)	(330)	(832)		(745)	(258)	(265)	(43)	(57)	(288)	(110)	(9)

Approximate Dimensions in Inches (mm)

FR9 Enclosure Dimensions

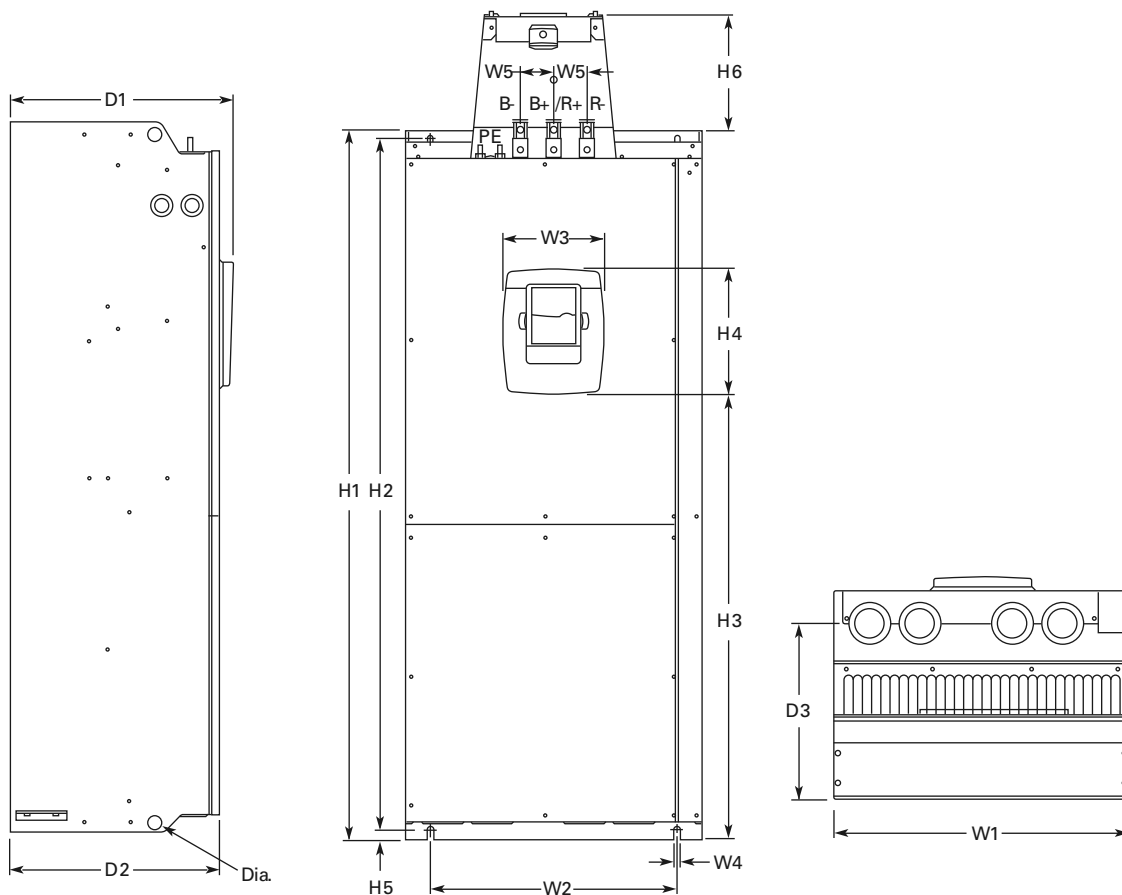

Frame Size	Voltage	W1	W2	W3	W4	W5	H1	H2	H3	H4	H5	H6 ①	D1	D2	D3	Dia.
FR9	480V	18.8	15.75	6.5	0.35	2.12	45.27	44	28.3	8	0.62	7.4	14.25	13.38	11.22	0.82
	575V	(480)	(400)	(165)	(9)	(54)	(1150)	(1120)	(721)	(205)	(16)	(188)	(362)	(340)	(285)	(21)

Note

① Brake resistor terminal box (H6) included when brake chopper ordered.

Technical Data

Approximate Dimensions in Inches (mm)

FR9 with Flange Kit Enclosure Dimensions

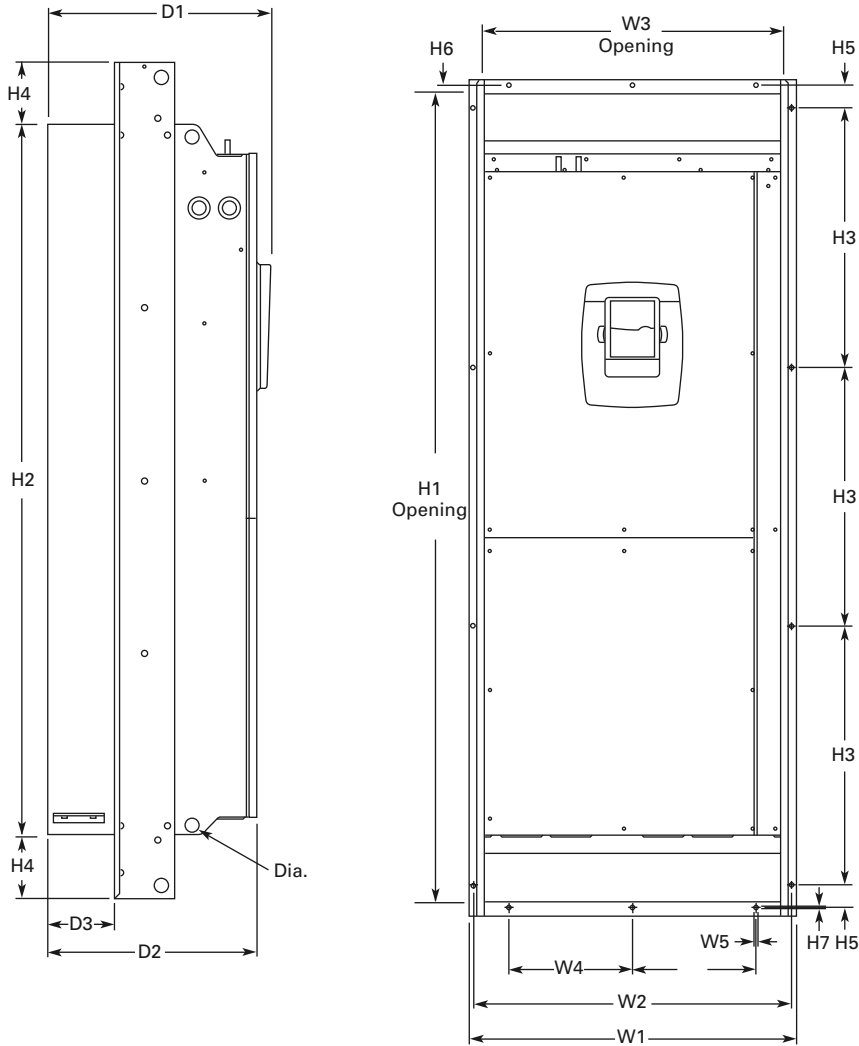

Frame Size	Voltage	W1	W2	W3	W4	W5	H1	H2	H3	H4	H5	H6	H7	D1	D2	D3	Dia.
FR9	480V	20.9	20	19.1	7.9	0.22	51.7	45.3	16.5	3.9	1.4	0.35	0.08	24.9	13.4	4.3	0.8
	575V	(530)	(510)	(485)	(200)	(5.5)	(1312)	(1150)	(420)	(100)	(35)	(9)	(2)	(362)	(340)	(109)	(21)

Approximate Dimensions in Inches (mm)

Power Unit—SPX9000 FR10–FR14

SPX9000, FR10 Open Chassis

Note: SPX9000 FR12 is built of two FR10 modules.

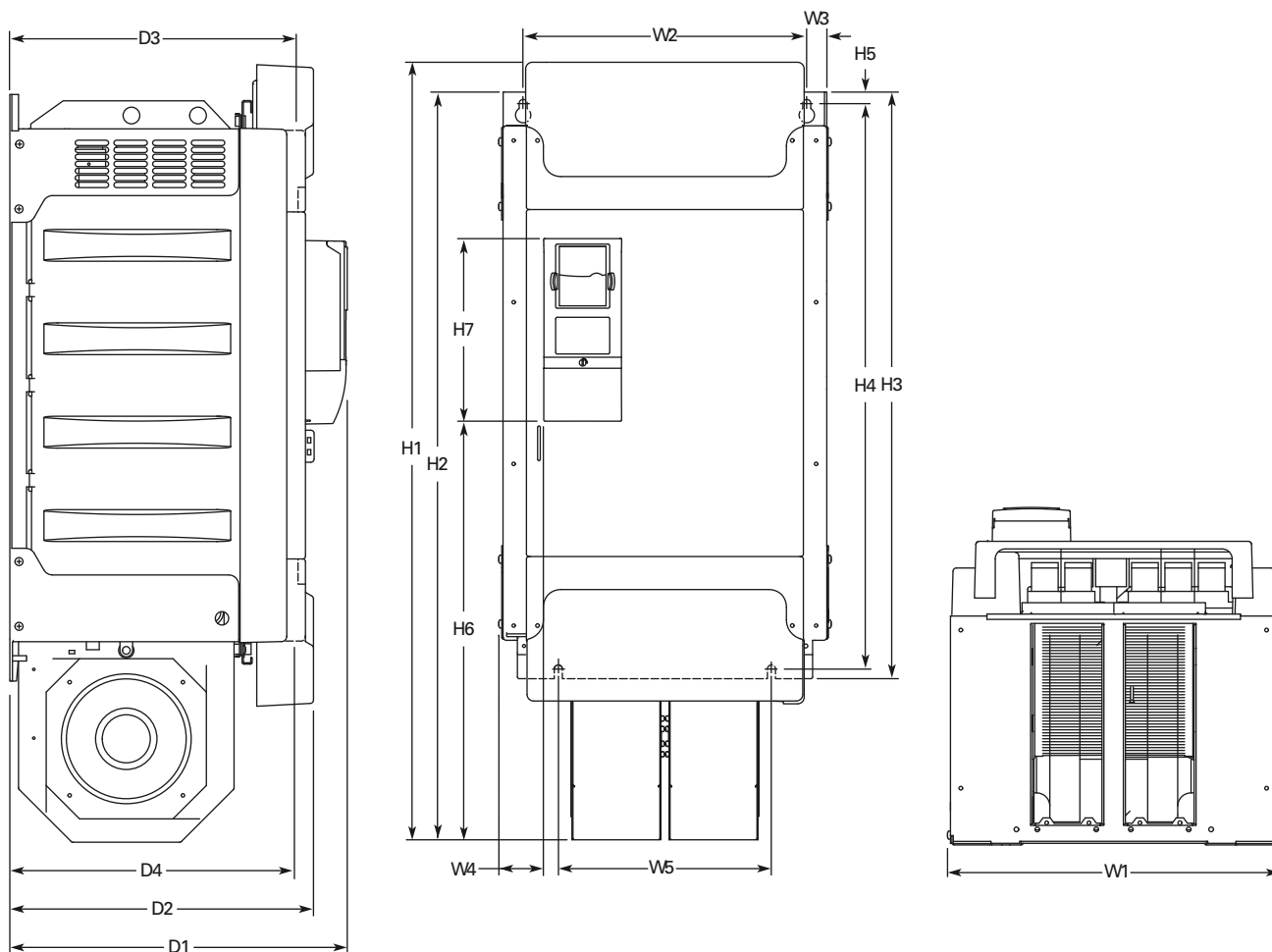

Frame Size	Voltage	hp (I _H)	W1	W2	W3	W4	W5	H1	H2	H3	H4
FR10	480V	250–350	19.7	16.7	1.2	2.6	12.8	45.9	44.1	34.6	33.5
	575V	200–300	(500)	(425)	(30)	(67)	(325)	(1165)	(1121)	(879)	(850)

Frame Size	Voltage	hp (I _H)	H5	H6	H7	D1	D2	D3	D4	Weight Lbs (kg)
FR10	480V	250–350	0.7	24.7	10.8	19.9	17.9	16.7	16.6	518 (235)
	575V	200–300	(17)	(627)	(275)	(506)	(455)	(423)	(421)	

Technical Data

Approximate Dimensions in Inches (mm)

SPX9000, FR11 Open Chassis

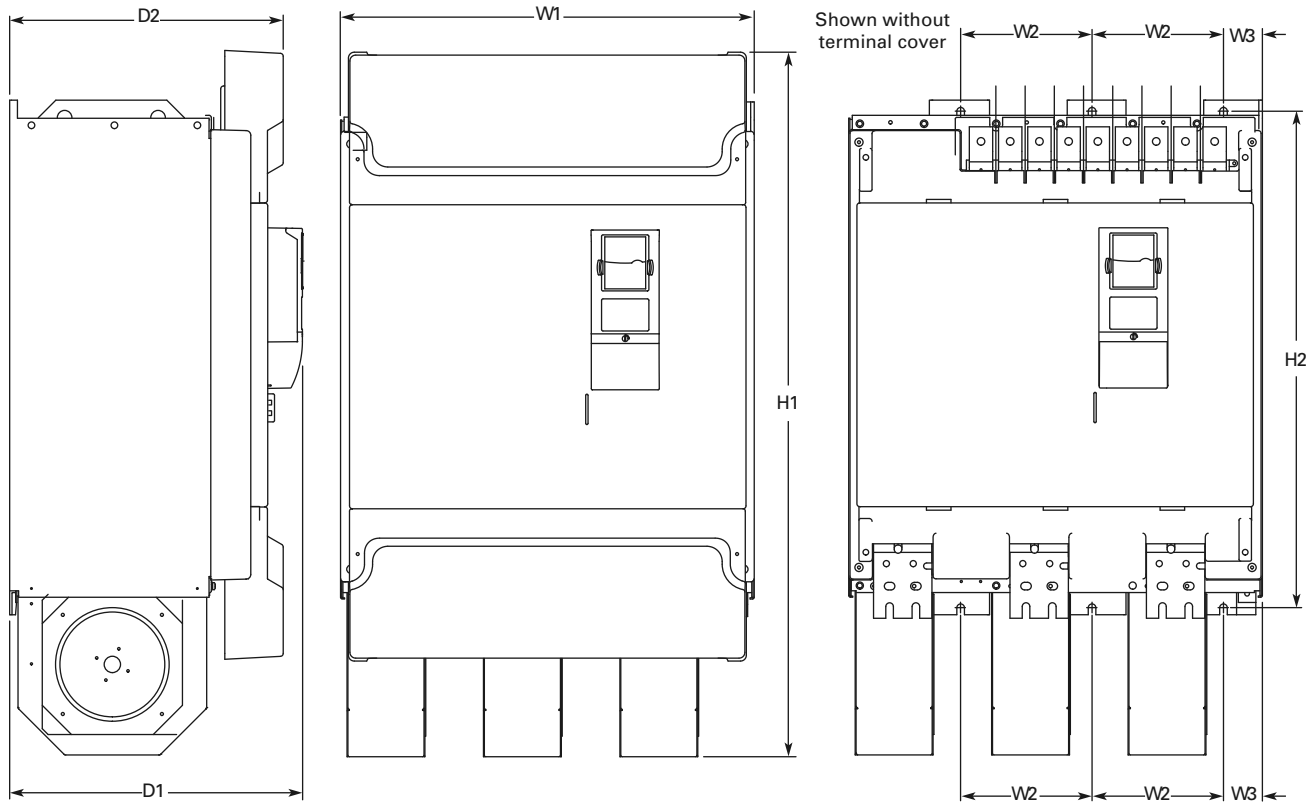

Frame Size	Voltage	hp (I _H)	W1	W2	W3	H1	H2	D1	D2	Weight Lbs (kg)
FR11	480V	400–550	27.9	8.6	2.6	45.5	33.5	19.8	18.4	833 (378)
	575V	400–500	(709)	(225)	(67)	(1155)	(850)	(503)	(468)	

Approximate Dimensions in Inches (mm)

SPX9000, FR13 Open Chassis Inverter

Note: 9000X FR14 is built of two FR13 modules.
FR13 is built from an inverter module and a converter module.

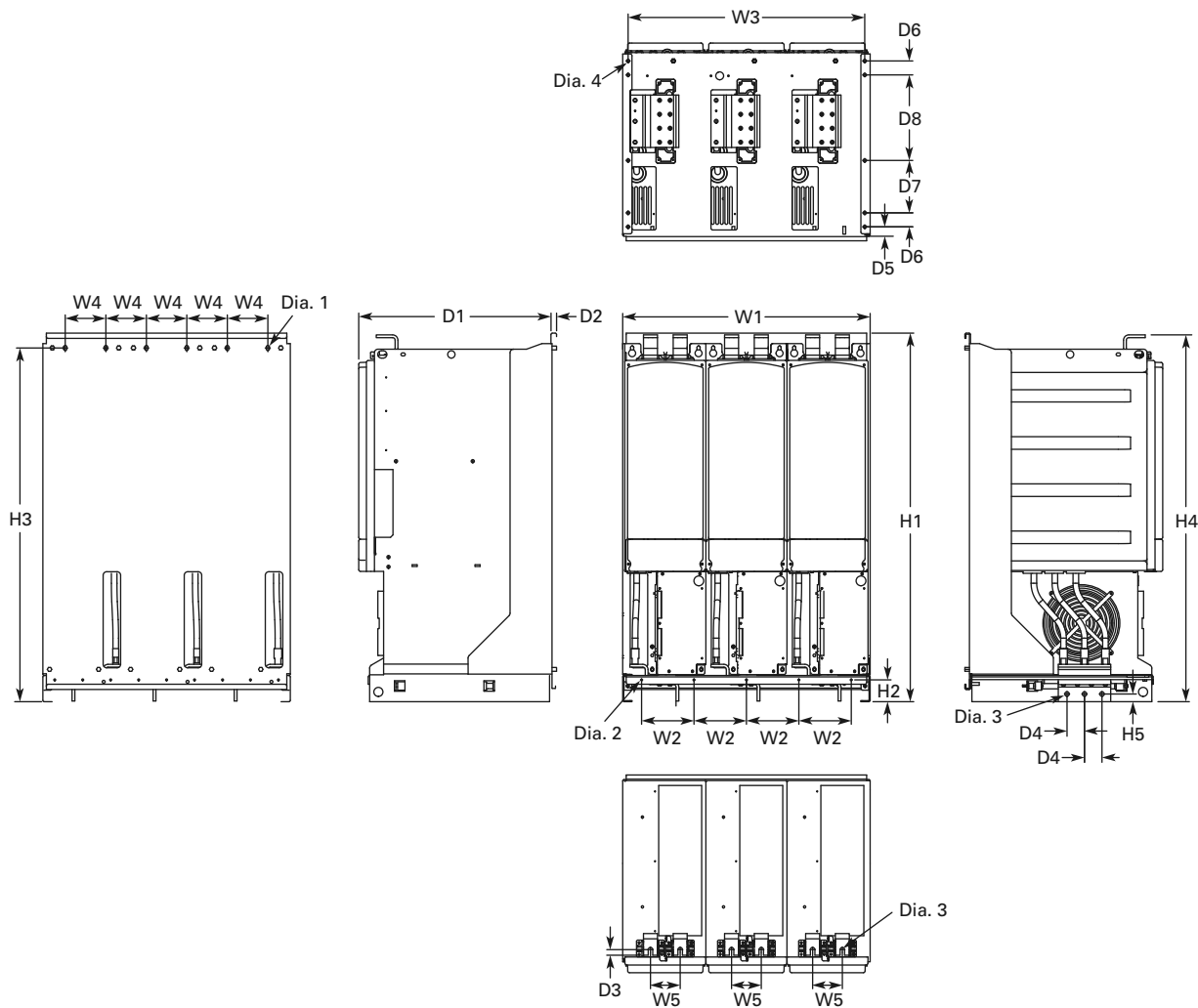

Frame Size	W1	W2	W3	W4	W5	H1	H2	H3	H4	H5
FR13	27.87 (708)	5.91 (150)	26.65 (677)	4.57 (116)	3.35 (85)	41.54 (1055)	2.46 (62.5)	39.86 (1012.5)	41.34 (1050)	0.79 (20)

Frame Size	D1	D2	D3	D4	D5	D6	D7	D8	Dia. 1	Dia. 2	Dia. 3	Dia. 4	Weight Lbs (kg)
FR13	21.77 (553)	0.51 (13)	0.63 (16)	1.97 (50)	1.06 (27)	1.57 (40)	5.91 (150)	9.64 (244.8)	0.35 x 0.59 (9x15)	0.18 (4.6)	0.51 (13)	0.37 (9.5)	683 (310)

Technical Data

Approximate Dimensions in Inches (mm)

SPX9000, FR13 Open Chassis Converter

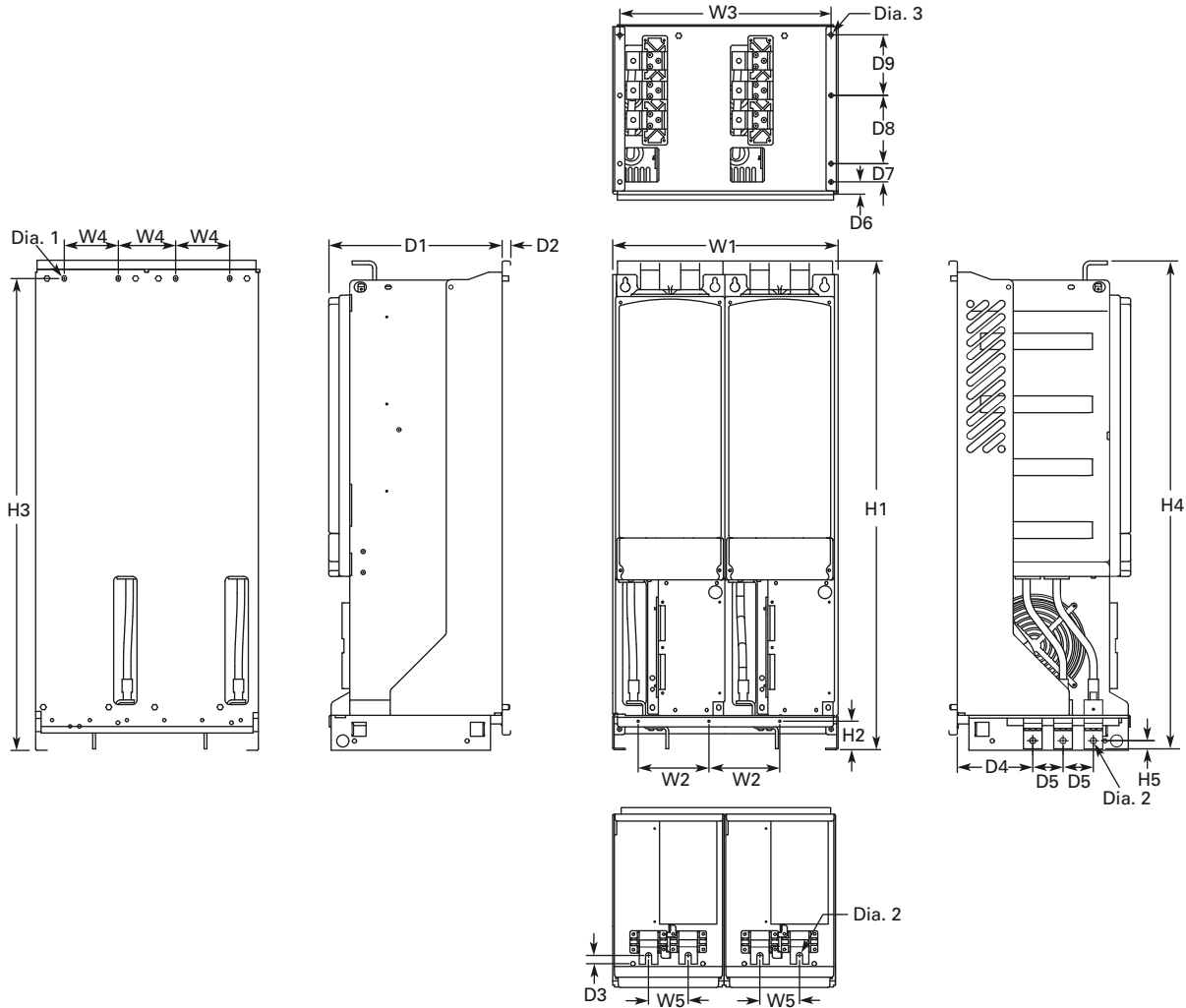

Frame Size	W1	W2	W3	W4	W5	H1	H2	H3	H4	H5
FR13	18.74 (476)	5.91 (150)	17.52 (445)	4.57 (116)	3.35 (85)	41.54 (1055)	2.46 (62.5)	39.86 (1012.5)	41.34 (1050)	0.69 (17.5)

Frame Size	D1	D2	D3	D4	D5	D6	D7	D8	D9	Dia. 1	Dia. 2	Dia. 3	Weight Lbs (kg)
FR13	14.69 (373)	.51 (13)	0.73 (18.5)	6.42 (163)	2.56 (65)	1.06 (27)	1.57 (40)	5.91 (150)	5.24 (133)	0.35 x 0.59 (9 x 15)	0.51 (13)	0.37 (9.5)	295 (134)

FR13—Number of Input Units

480V	hp	Input Modules	690V	hp	Input Modules
SPX800A0-4A2N1	800	2	SPX800A0-5A2N1	800	2
			SPX900A0-5A2N1	900	2
			SPXH10A0-5A2N1	1000	2

Approximate Dimensions in Inches (mm)

SPX9000, FR13 Open Chassis Converter—900/1000 hp 480V

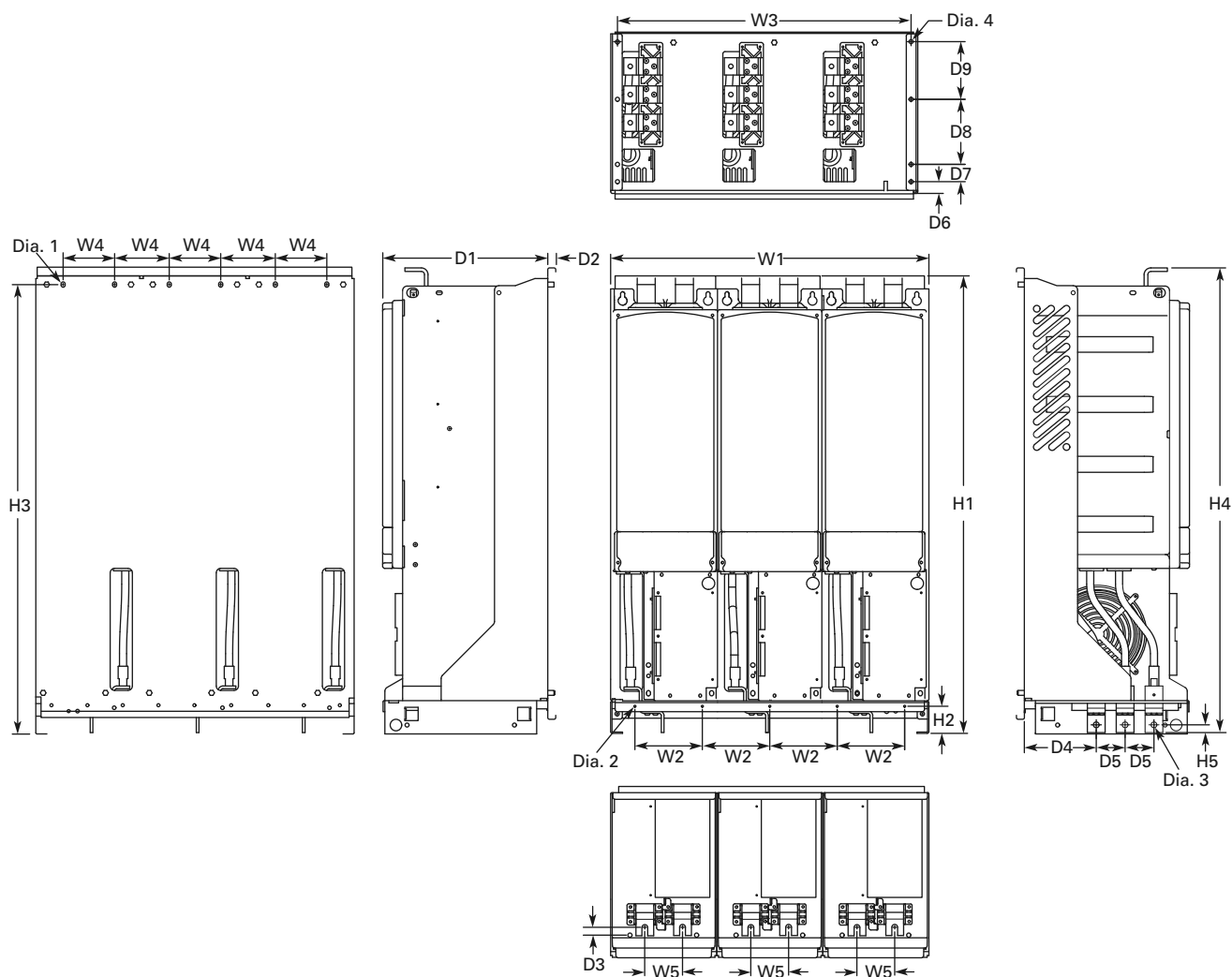

Frame Size	W1	W2	W3	W4	W5	H1	H2	H3	H4	H5	D1	D2
FR13	27.87 (708)	5.91 (150)	26.65 (677)	4.57 (116)	3.35 (85)	41.54 (1055)	2.46 (62.5)	39.86 (1012.5)	41.34 (1050)	0.69 (17.5)	14.69 (373)	0.51 (13)

Frame Size	D3	D4	D5	D6	D7	D8	D9	Dia. 1	Dia. 2	Dia. 3	Dia. 4	Weight Lbs (kg)
FR13	0.73 (18.5)	6.42 (163)	2.56 (65)	1.06 (27)	1.57 (40)	5.91 (150)	5.24 (133)	0.35 x 0.59 (9 x 15)	0.18 (4.6)	0.51 (13)	0.37 (9.5)	443 (201)

FR13—Number of Input Units

480V	hp	Input Modules
SPX900A0-4A2N1	900	3
SPXH10A0-4A2N1	1000	3

Technical Data

Approximate Dimensions in Inches (mm)

AC Choke—CHK0650

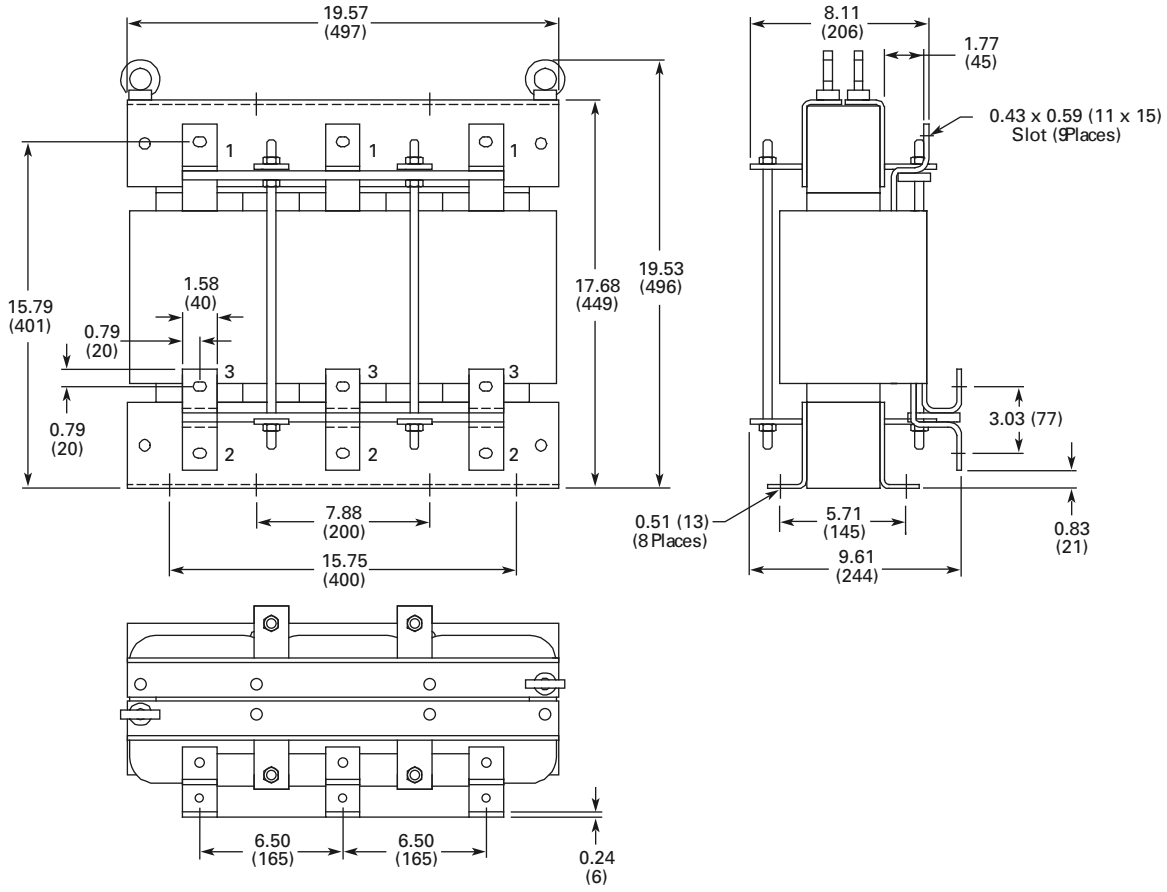

Approximate Dimensions in Inches (mm)

AC Choke—CHK0520

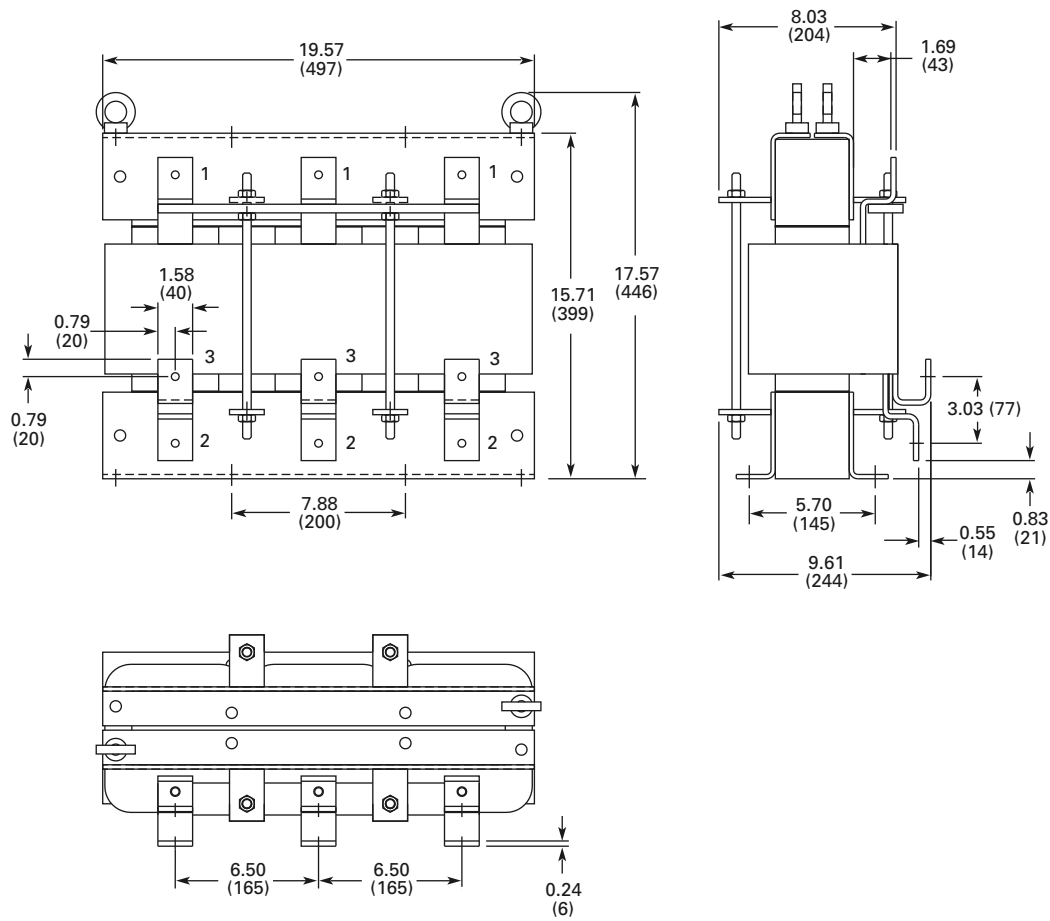

Technical Data

Approximate Dimensions in Inches (mm)

AC Choke—CHK0400

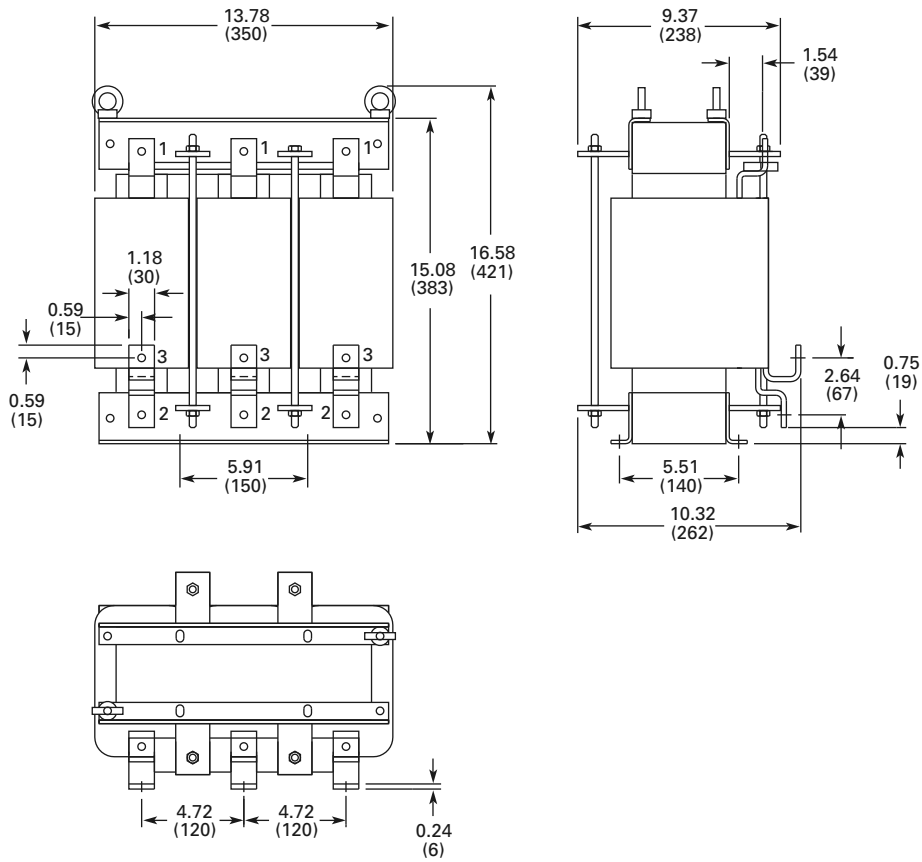

Approximate Dimensions in Inches (mm)

AC Choke—CHK0261

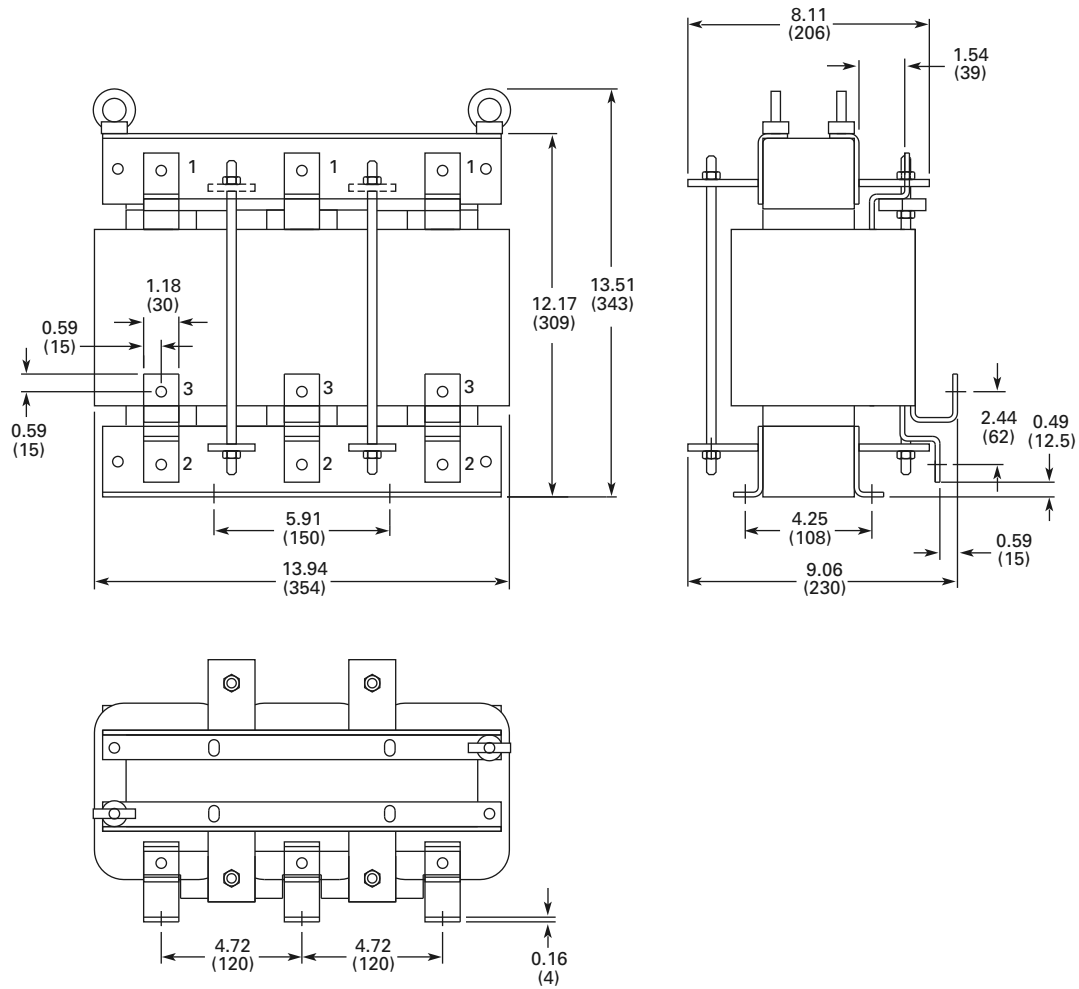

Technical Data

Approximate Dimensions in Inches (mm)

Control Unit—SPX9000 FR10–FR14

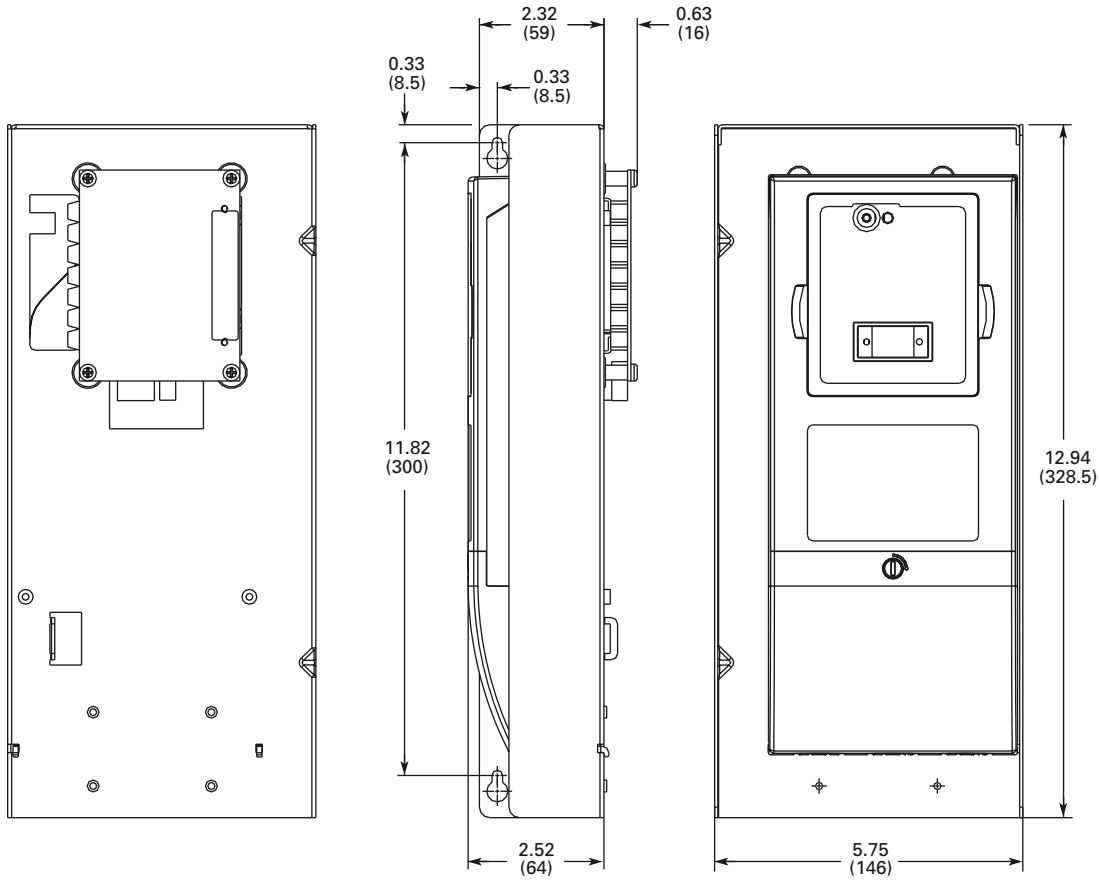

Approximate Dimensions in Inches (mm)

Control Unit with Star-Coupler Board, FR12 or FR14 Only

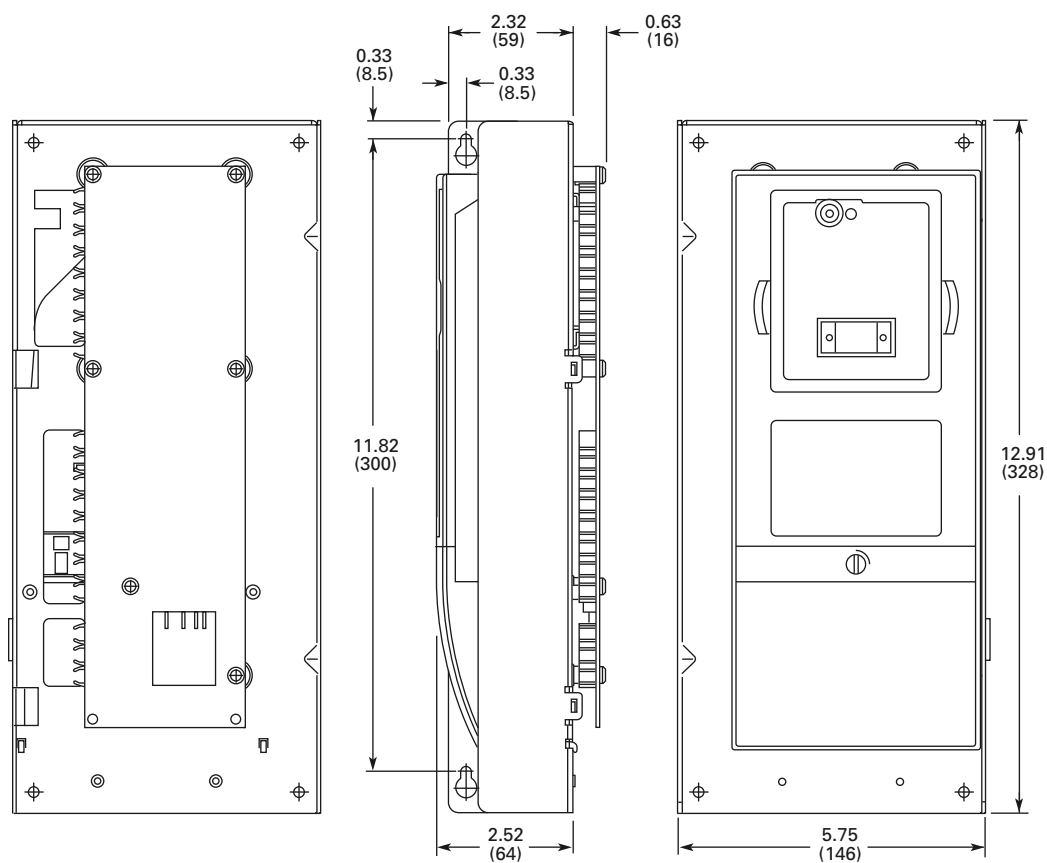

EMC Capability

General

For products used within the European Community (EC), the Electro Magnetic Compatibility (EMC) directive states that the electrical equipment must not disturb the environment and must be immune to other Electro Magnetic Disturbances in the environment.

The design intent was to develop a family of drives that is user friendly and cost-effective, while fulfilling the user's needs. EMC compliance was a major consideration from the outset of the design.

The SVX9000/SPX9000 drive series is targeted for the world market. To ensure maximum flexibility, yet meet the EMC needs of different regions, all drives meet the highest immunity levels, while emission levels meet the requirements noted in the following section.

EMC Classification

The SVX9000/SPX9000 drive series are EMC classification H capable.

Class H

SVX9000/SPX9000 drives have been designed to fulfill the requirements of the product standard EN 61800-3+A11 for the 1st environment restricted distribution and the 2nd environment.

The emission levels correspond to the requirements of EN 61000-6-4.

SVX9000/SPX9000 series drives fulfill all applicable EMC immunity requirements (standards EN 61000-6-1, EN 61000-6-2, and EN 61800-3+A11).

Declaration of Conformity

The Manufacturer's Declarations of Conformity ensuring the compliance of the SVX9000/SPX9000 drives with the European Community (EC) EMC directives is available upon request.

Warranty and Liability Information

Eaton Electrical Inc. warrants the product delivered in the Eaton shipping package to be free from defects in material and workmanship, under normal use and service, for twenty four (24) months from date of manufacturing. Products that fail during this period will be repaired or replaced at Eaton's discretion, with the same or a functionally equivalent product, provided the original purchaser (A) returns the failed product, and (B) provides proof of original date of purchase. This warranty does not apply, in the judgment of Eaton, to damage caused during shipment, handling, storage, or accidental misuse. The original purchaser of the product must obtain a Eaton Return Material Authorization (RMA) number prior to returning any defective product. (When purchased through an Authorized Distributor, the Distributor should supply an RMA number to their customer.)

The maximum liability of this warranty is limited to the purchase price of the product. In no event, regardless of cause, shall Eaton Electrical Inc. be liable (a) for penalties or penalty clauses of any description, or (b) for certification not otherwise specifically provided herein and/or indemnification of purchaser or others for costs, damages or expenses, each arising out of or related to the product or services of any order or (c) for any damages resulting from loss of profits, use of products or for any incidental indirect or consequential damages, even if advised of the possibility of such damages.

Fault and Warning Codes

In the SVX9000/SPX9000 drive there are four different types or "Levels" of faults, each level corresponding to the severity of the fault. The fault types differ from each other on the basis of the drive response to the fault. See Fault Codes table below and on **Pages 82 and 83** for descriptions.

The faults with one asterisk are "Fault" only. The faults with two asterisks can be programmed for different actions based on the chosen application. See the appropriate application manual for specific application details.

Fault Type Categories

Fault Type	Fault Level/Significance
First Level Fault (* next to fault numbers)	A minor fault A First Level Fault indicates an unusual operating condition has occurred. It does not cause the drive to stop, and it does not require any action to be taken. The fault indication remains in the display for about 30 seconds.
Second Level Fault (** next to fault numbers)	A significant fault The drive response to a Second Level Fault can be programmed in the application. A Second Level Fault will cause the drive to stop. Corrective action needs to be taken in order to restart the drive.
Third Level Fault (auto resetting)	A major fault If a Third Level Fault occurs the drive will also stop immediately. The fault is reset automatically and the drive will try to restart the motor. Finally, if the restart is not successful, a Top Level Fault trip occurs (see below).
Top Level Fault	A final fault If the drive is unable to restart the motor after a Third Level Fault, a Top Level Fault occurs. The effect of the Top Level Fault is the same as that of the Second Level Fault except that the drive is stopped and remains stopped until corrective is taken and the drive is reset.

Fault Codes

Fault Code	Fault	Possible Cause	Solution
1	Overcurrent	The SVX9000/SPX9000 has detected a high current ($>4 \times I_n$) in its output due to: <ul style="list-style-type: none"> • sudden heavy load increase • short in the motor • short in the cables to the motor • unsuitable motor 	Check loading Check motor Check cables
2	Overvoltage	The DC link voltage has exceeded its high limit due to: <ul style="list-style-type: none"> • too short a deceleration time • high voltage levels or surges in the utility supply 	Make the deceleration time longer Use a chopper and brake resistor (standard on some models, available as an option on others) Correct utility supply voltage (level is too high) Add input impedance to limit surges
3**	Ground (earth) fault	Current sensing indicates that the sum of motor phase currents is not zero <ul style="list-style-type: none"> • insulation failure in motor or motor cables 	Check the motor and motor cables
5	Charging switch	The charging switch was open when the START command was been given due to: <ul style="list-style-type: none"> • faulty operation • component failure 	Reset the fault and restart. Should the fault reoccur, contact your Eaton distributor
6	Emergency stop	An Emergency stop signal was received from one of the digital inputs	Determine the reason for the Emergency stop and remedy it

Fault and Warning Codes

Fault Codes, continued

Fault Code	Fault	Possible Cause	Solution
7	Saturation trip	Defective component Motor or motor cable short	Cannot be reset from the keypad Switch off power If this fault appears simultaneously with Fault 1, check the motor and motor cables IF THE PROBLEM IS NOT IN THE MOTOR OR ITS CABLES, DO NOT RECONNECT POWER! Contact your Eaton distributor
8	System fault	Component failure Faulty operation Exceptional fault data record, see the Active Fault Menu and Fault Time Data Record for more information	Reset the fault and restart Should the fault reoccur, contact your Eaton distributor
9**	Undervoltage	DC link voltage is less than the minimum safe operating voltage limit <ul style="list-style-type: none"> • most probable cause: supply voltage too low • SVX9000/SPX9000 internal fault 	If there was a supply voltage loss or dip, reset the fault and restart the SVX9000/SPX9000. Check the supply voltage. If it was within specification at the time of the fault, an internal failure has occurred Contact your Eaton distributor
10**	Input line supervision	Input line phase is low or missing	Check the utility supply voltage, cables, and connections
11**	Output phase supervision	Current sensing indicates that there is no current in one motor phase	Check the motor cables, connections, and motor
12	Brake chopper supervision	No brake resistor installed Brake resistor is open Brake chopper failure	Check the brake resistor If the resistor is ok, the chopper is faulty. Contact your Eaton distributor
13	SVX9000/SPX9000 undertemperature	Heatsink temperature is under 14°F (–10°C)	Provide supplemental heating or relocate the SVX9000/SPX9000 to a warmer location
14	SVX9000/SPX9000 overtemperature	Heatsink temperature is over 194°F (90°C)	An overtemperature warning is issued when the heatsink temperature exceeds 185°F (85°C), a fault occurs at 194°F (90°C). Check for the correct amount and unrestricted flow of cooling air Check the heatsink for dust or dirt buildup Check the highest ambient temperature level Make sure that the switching frequency is not set too high in relation to ambient temperature and motor load
15**	Motor stalled	Motor or load mechanical failure Load is too high Stall parameter settings incorrect	Check motor, mechanical system, and load level Confirm the stall parameter settings
16**	Motor overtemperature	Motor is overloaded Motor overheating has been detected by the SVX9000/SPX9000 motor temperature model	Decrease the motor load If no motor overload exists, check the temperature model parameters
17**	Motor underload	Mechanical or load problems Underload parameter settings incorrect	Check the motor. Check for a loose belt, broken coupling or load problems. Confirm the underload parameter settings
22	EEPROM checksum fault	Parameter save fault due to: <ul style="list-style-type: none"> • faulty operation • component failure 	Upon reset of this fault, the SVX9000/SPX9000 will automatically reload the parameter default settings. Check all parameter settings after reset. If the fault reoccurs, contact your Eaton distributor
24*	Counter fault	Values displayed on the counters are incorrect	—
25	Microprocessor watchdog fault	Faulty operation Component failure	Reset the fault and restart Should the fault reoccur, contact your Eaton distributor
26	Startup prevented	Startup of the drive has been prevented	Check Start Enable/Interlock settings

Fault Codes, continued

Fault Code	Fault	Possible Cause	Solution
29**	Thermistor fault	The thermistor input of an option board has detected a high motor temperature	Check the motor cooling and the motor loading Check the thermistor connection (If the thermistor input of an option board is not being used, it must be short-circuited)
31	IGBT temperature (hardware)	IGBT inverter bridge overtemperature protection has detected a high short-term overload current	Check loading Check motor size
32	Fan cooling	The SVX9000/SPX9000 cooling fan did not start when commanded	Contact your Eaton distributor
34	CAN bus communication	Sent message not acknowledged	Ensure that there is another device on the bus with the appropriate configuration
36	Control unit	The control unit cannot control the power unit and vice-versa	Change the control unit
37*	Device change (same type)	Option board changed Different power rating of drive	Reset No Fault Time Data Record is made
38*	Device added (same type)	Option board added Drive of different power rating added	Reset No Fault Time Data Record is made
39*	Device removed	Option board removed Drive removed	Reset No Fault Time Data Record is made
40	Device unknown	Unknown option board or drive	Contact your Eaton distributor
41	IGBT temperature	IGBT inverter bridge overtemperature protection has detected a high short-term overload current	Check loading Check motor size
42**	Brake resistor overtemperature	Brake resistor overtemperature protection has detected excessive braking	Set the deceleration time longer Use an external brake resistor
43	Encoder fault	Exceptional fault data record, see the Active Fault Menu and Fault Time Data Record for more information. Additional codes: 1 = Encoder 1 channel A is missing 2 = Encoder 1 channel B is missing 3 = Both encoder 1 channels are missing 4 = Encoder reversed	Check encoder channel connections Check the encoder board
44*	Device change (different type)	Option board changed Different power rating of drive	Reset No Fault Time Data Record is made Application parameter values restored to default
45*	Device added (different type)	Option board added Drive of different power rating added	Reset No Fault Time Data Record is made Application parameter values restored to default
50**	Analog input $I_{in} < 4$ mA (for the signal range 4 to 20 mA)	Current at the analog input is < 4 mA Control cable is broken or loose Signal source has failed	Check the current loop, signal source, and wiring
51	External fault	Digital input set as an external fault input has been triggered	Check source of trigger
52	Keypad communication fault	The connection between the control keypad and the SVX9000/SPX9000 has been lost	Check the keypad connection and keypad cable
53	Communication bus fault	The data connection between the communication bus master and the communication bus board has failed	Check installation If installation is correct contact your Eaton distributor
54	Slot fault	Defective option board or slot	Check that the board is properly installed and seated in slot. If the installation is correct, contact your Eaton distributor
56	PT100 board temperature fault	Temperature limit values set for the PT100 board parameters have been exceeded	Determine the cause of the high temperature

Troubleshooting Charts Using Fault Codes

Using Fault Codes

F1—Overcurrent

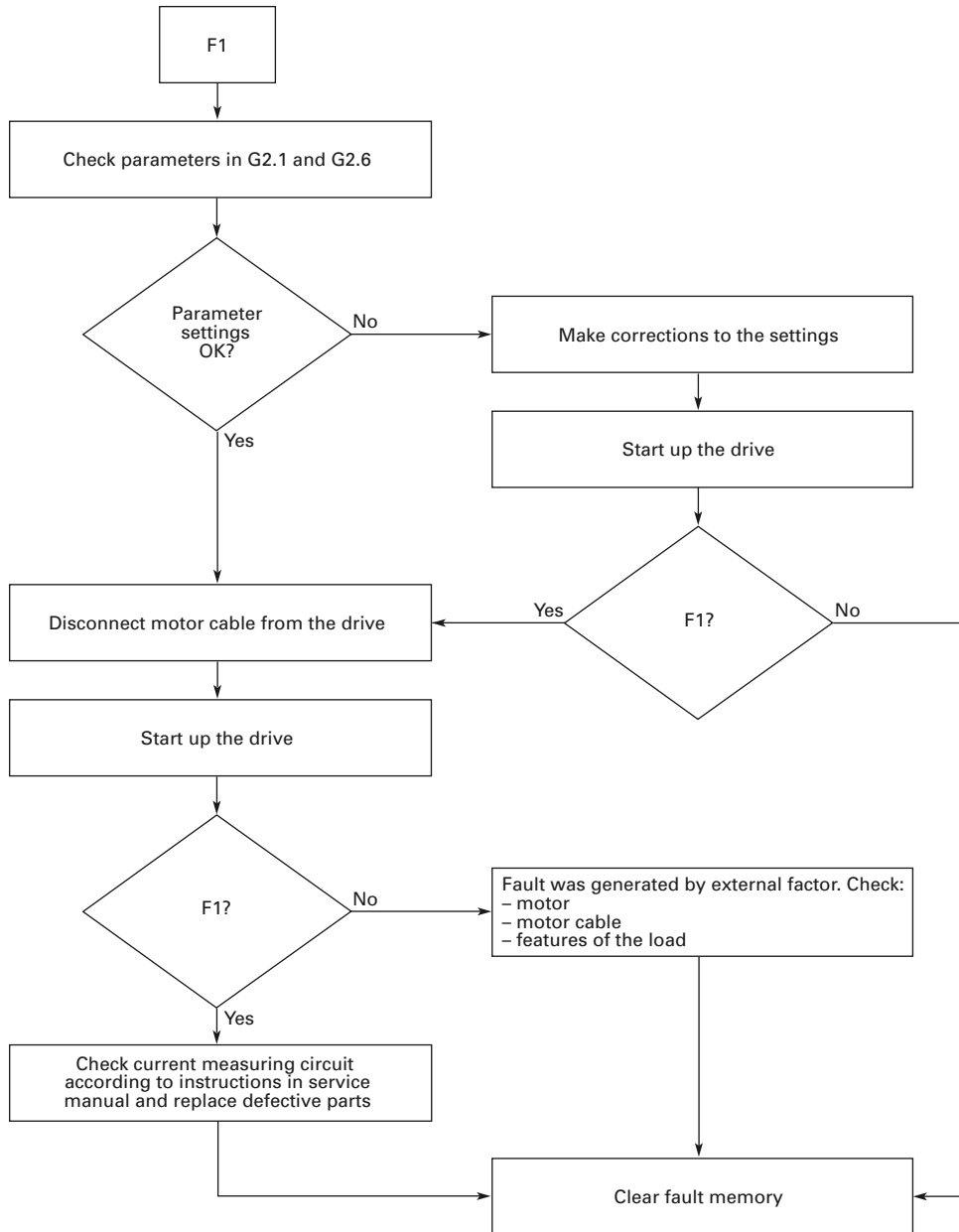

F2—Overvoltage

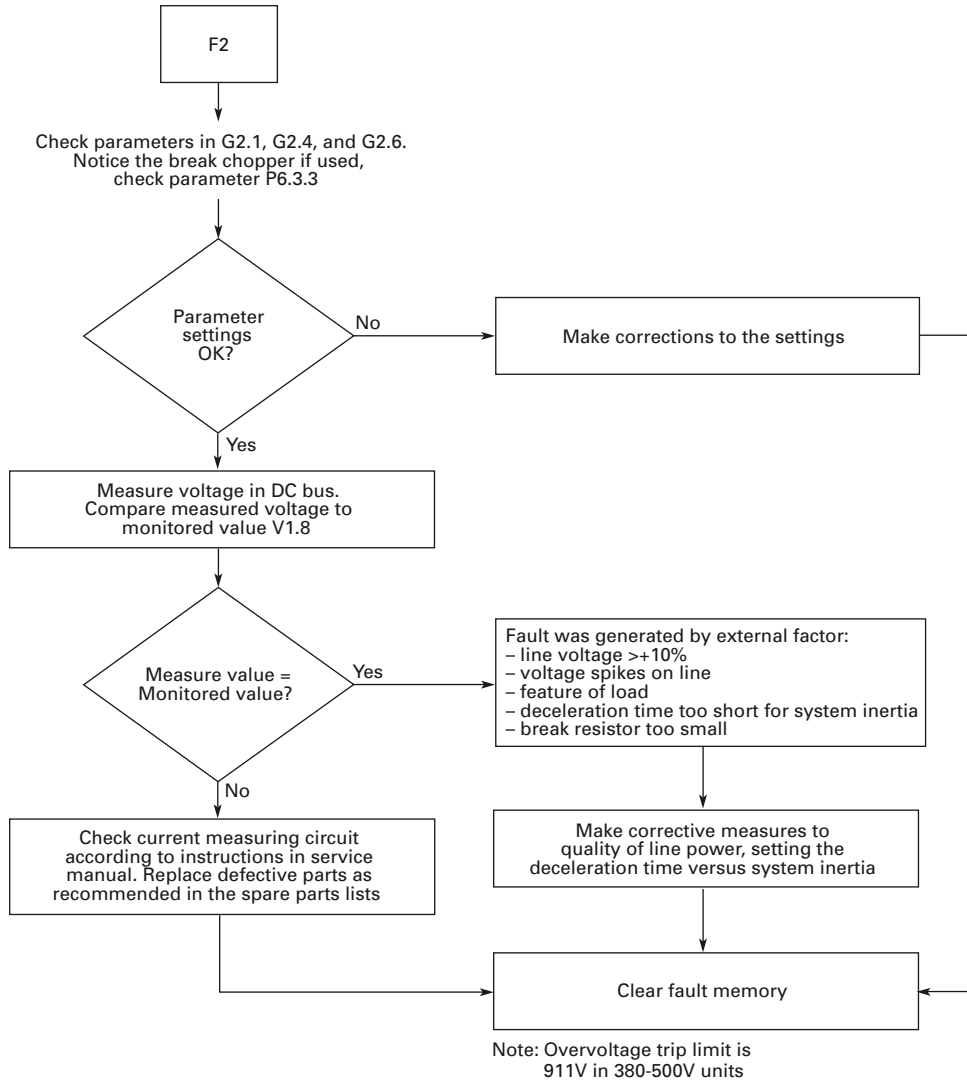

Troubleshooting Charts Using Fault Codes

F3—Earth Fault

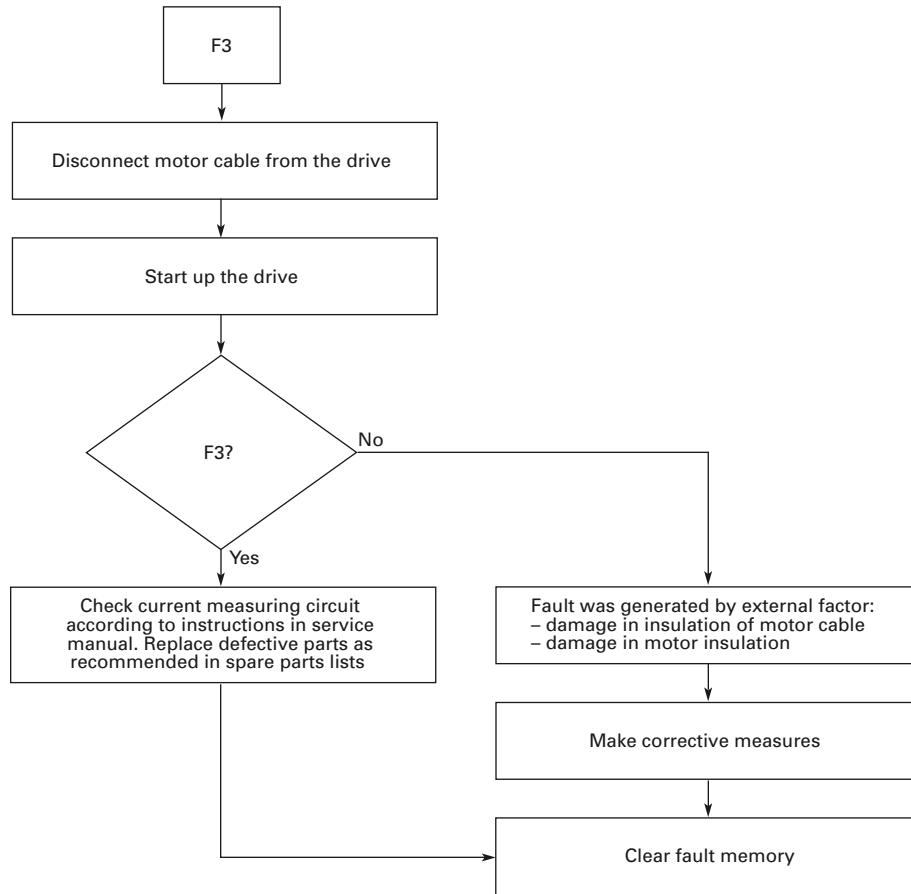

F5—Charging Switch

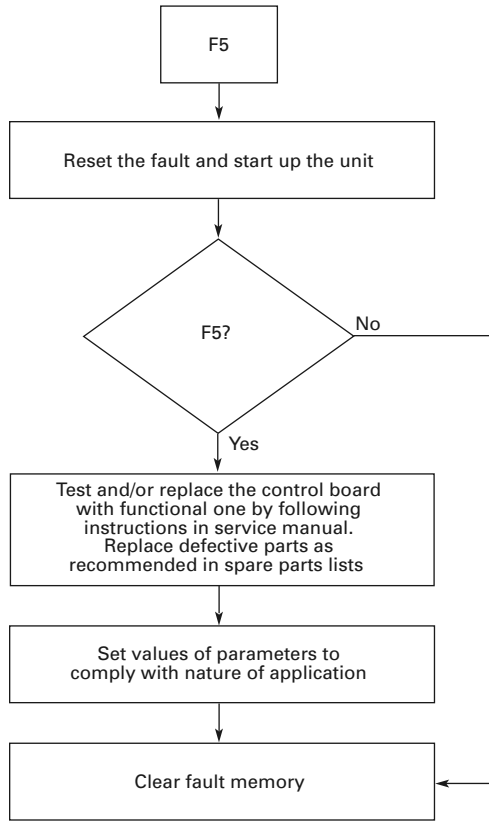

F6—Emergency Stop

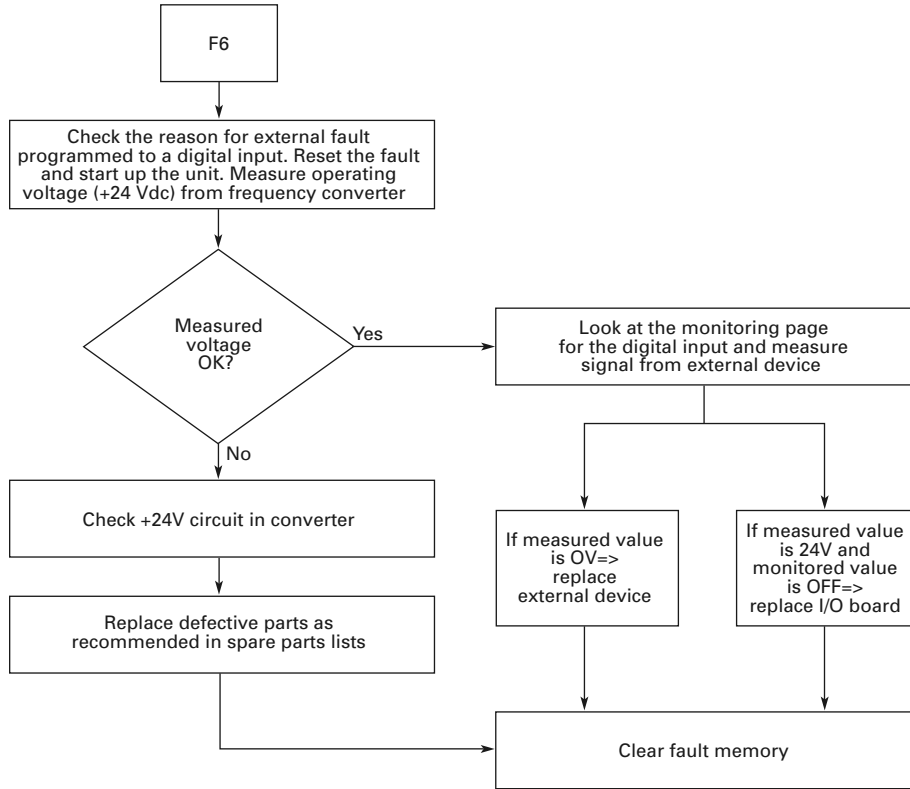

F7—Saturation Trip

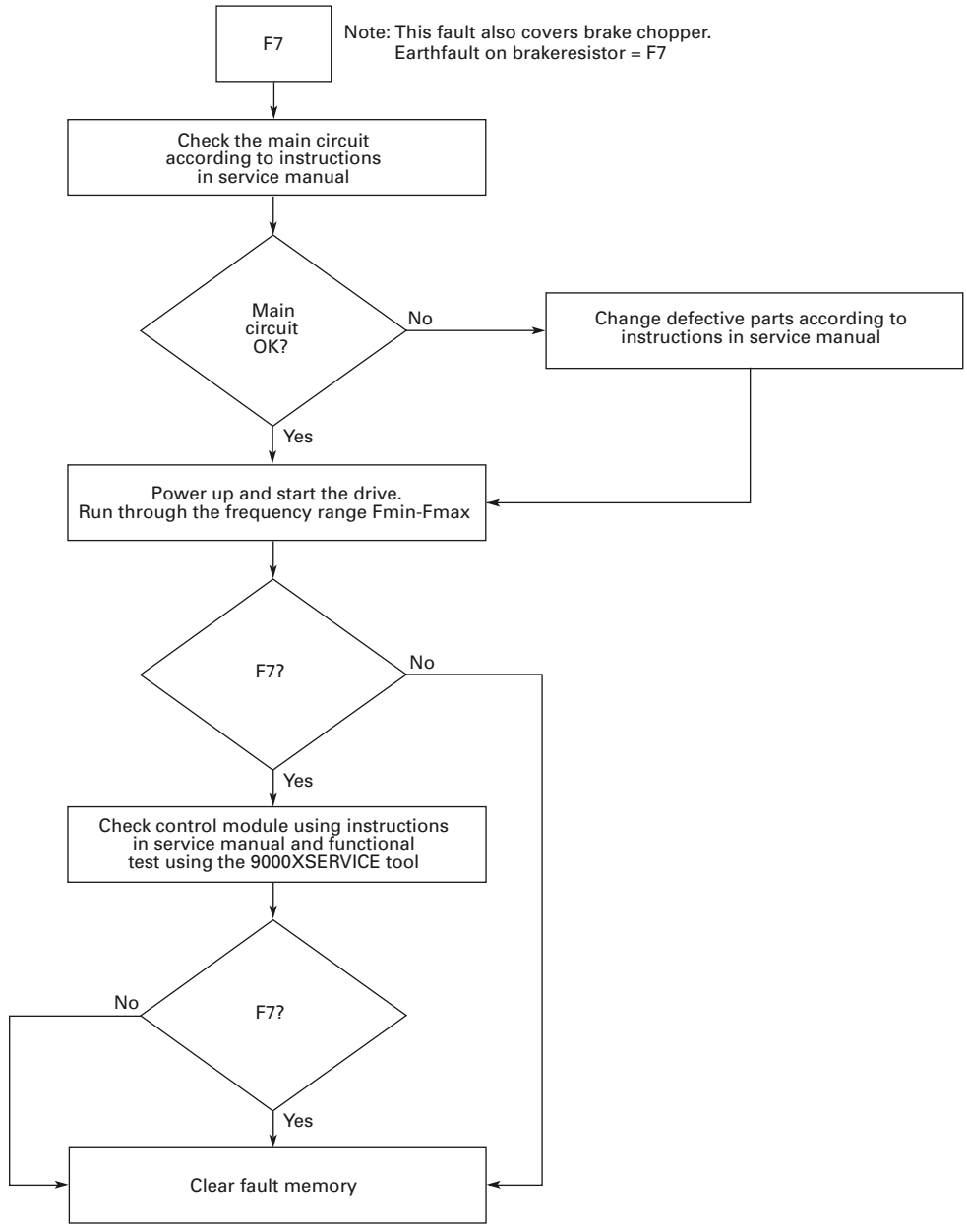

Troubleshooting Charts Using Fault Codes

F8—System Fault

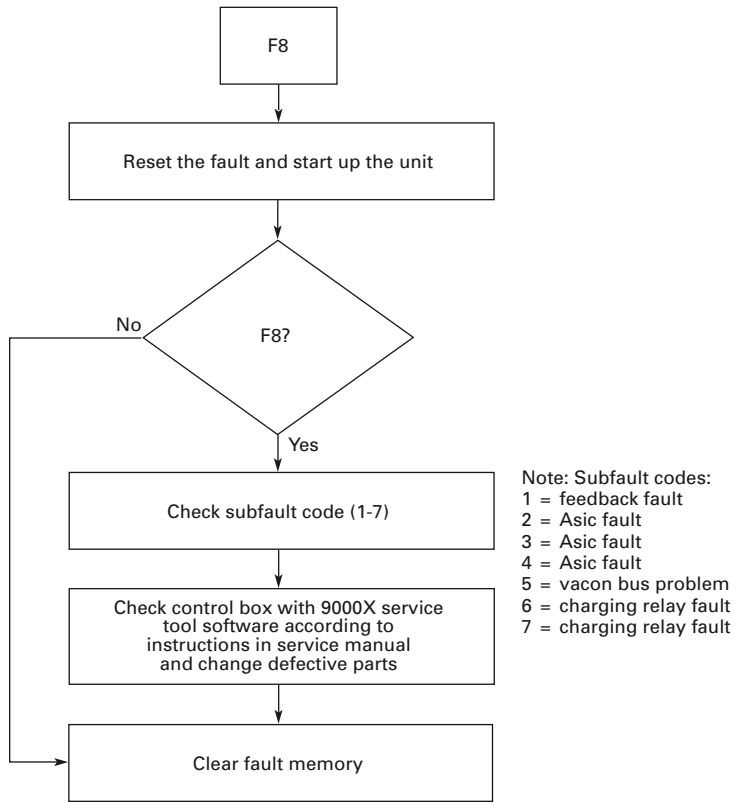

F9—Undervoltage

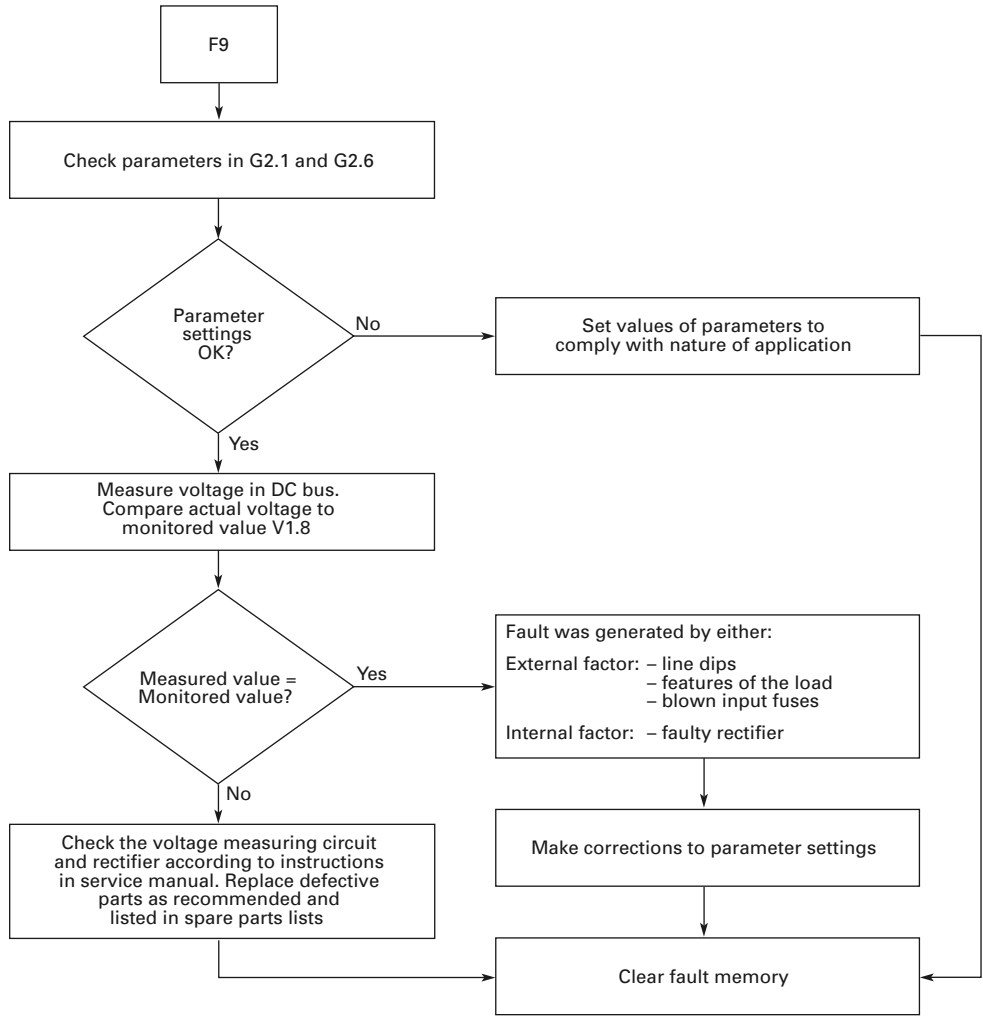

F10—Input Line Supervision

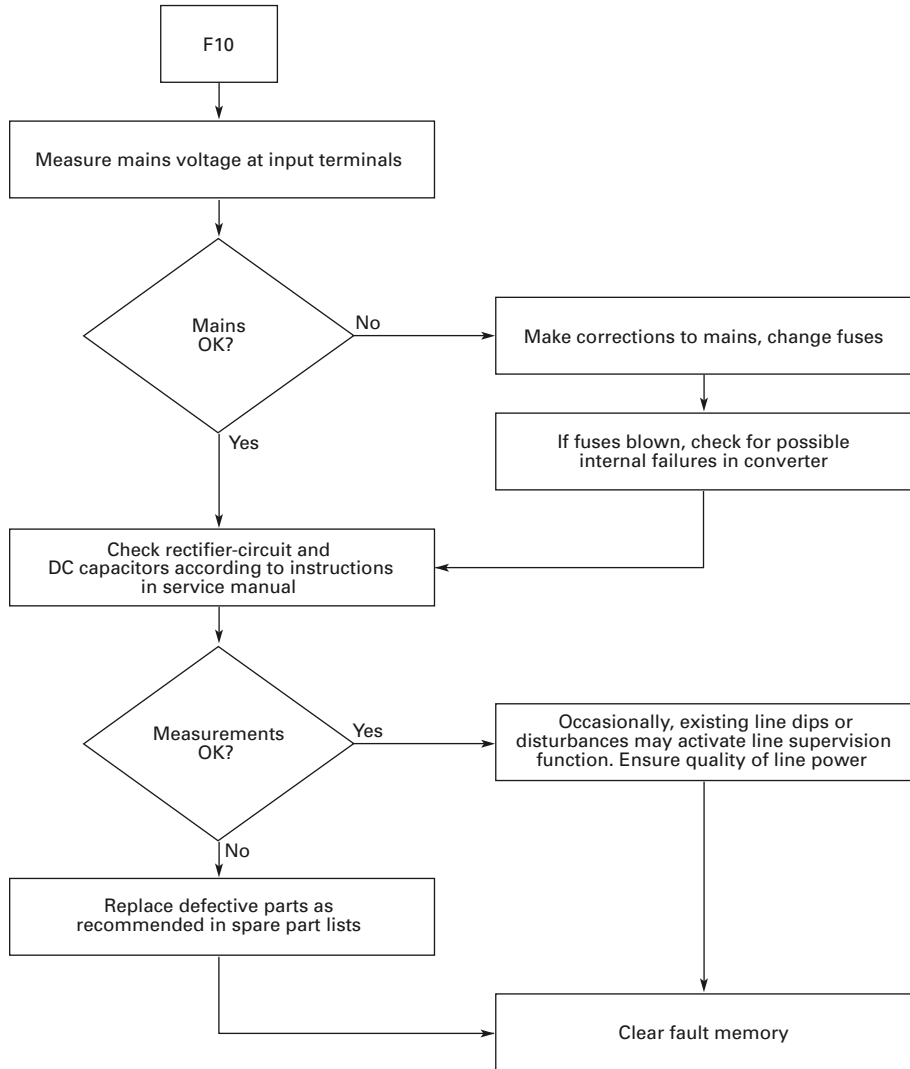

F11—Output Phase Supervision

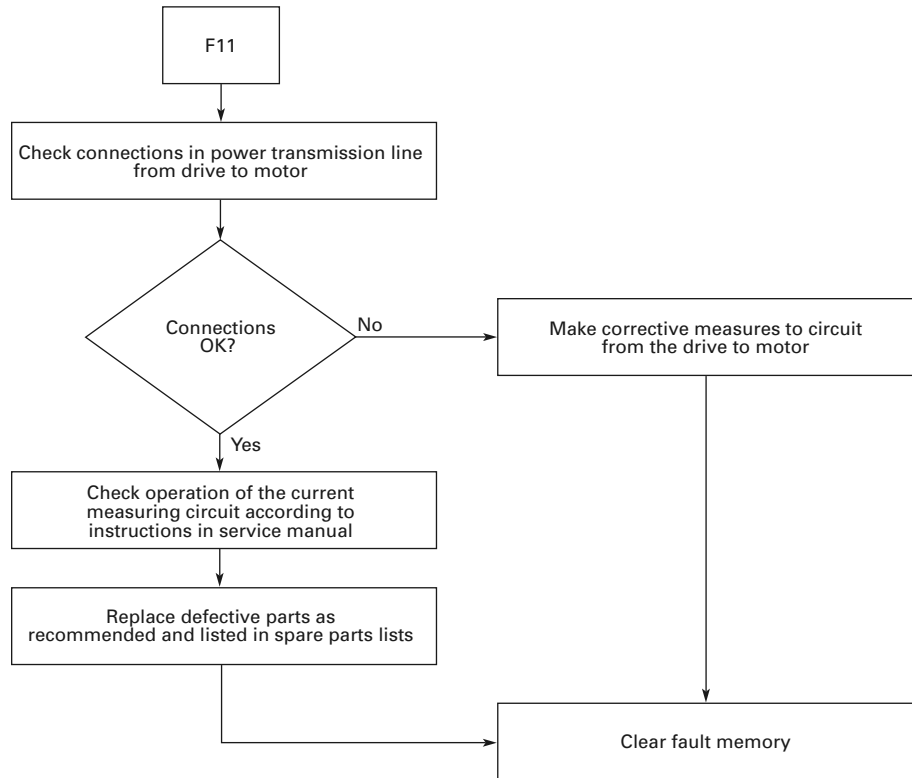

F12—Brake Chopper Supervision

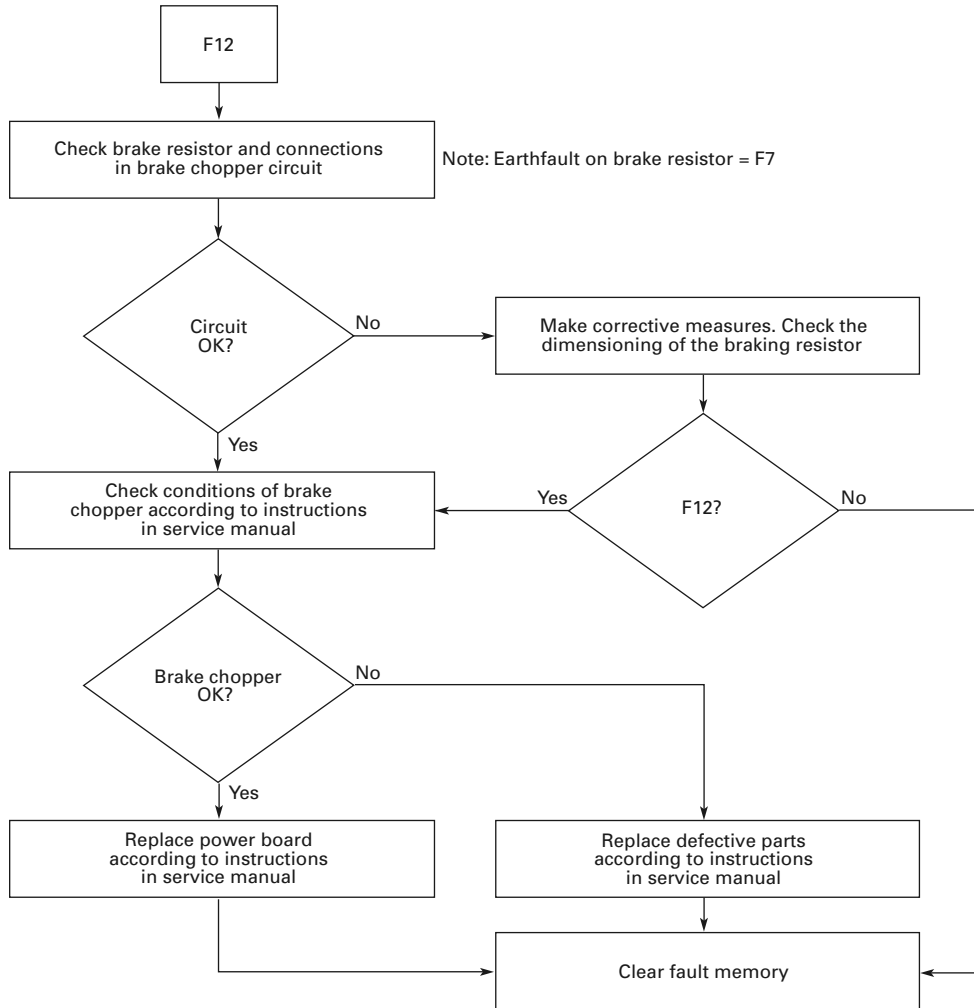

F13—Frequency Converter Under Temperature

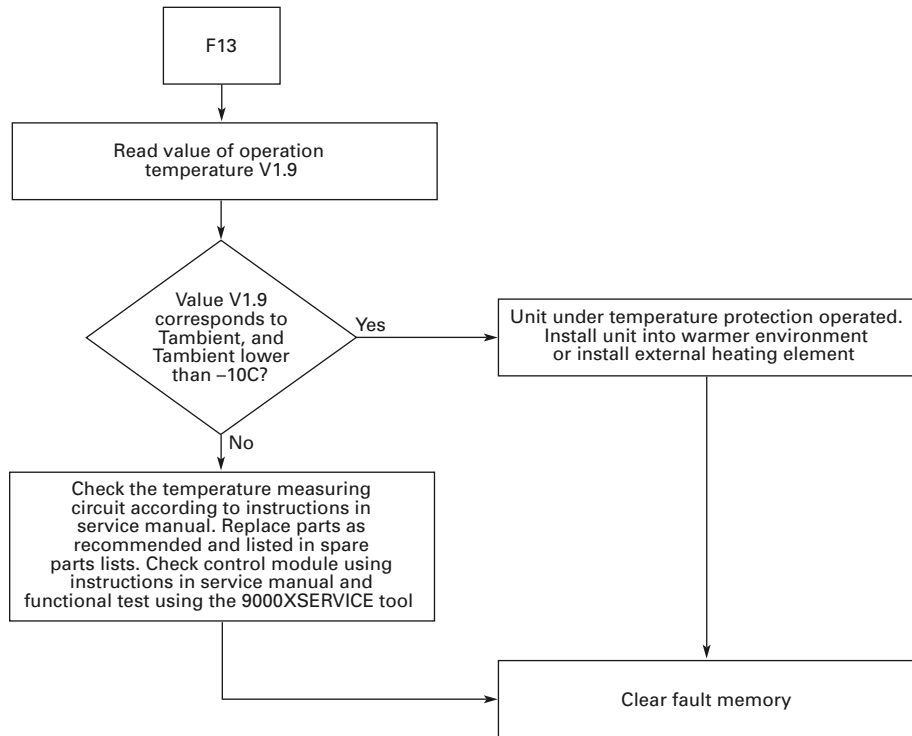

F14—Frequency Converter Over Temperature

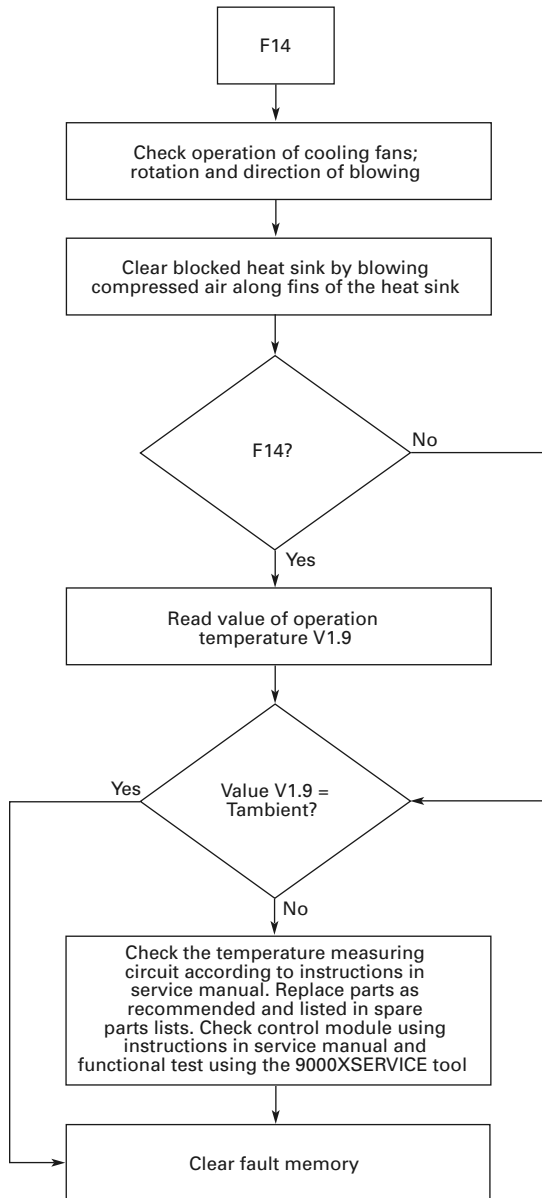

F15—Motor Stalled

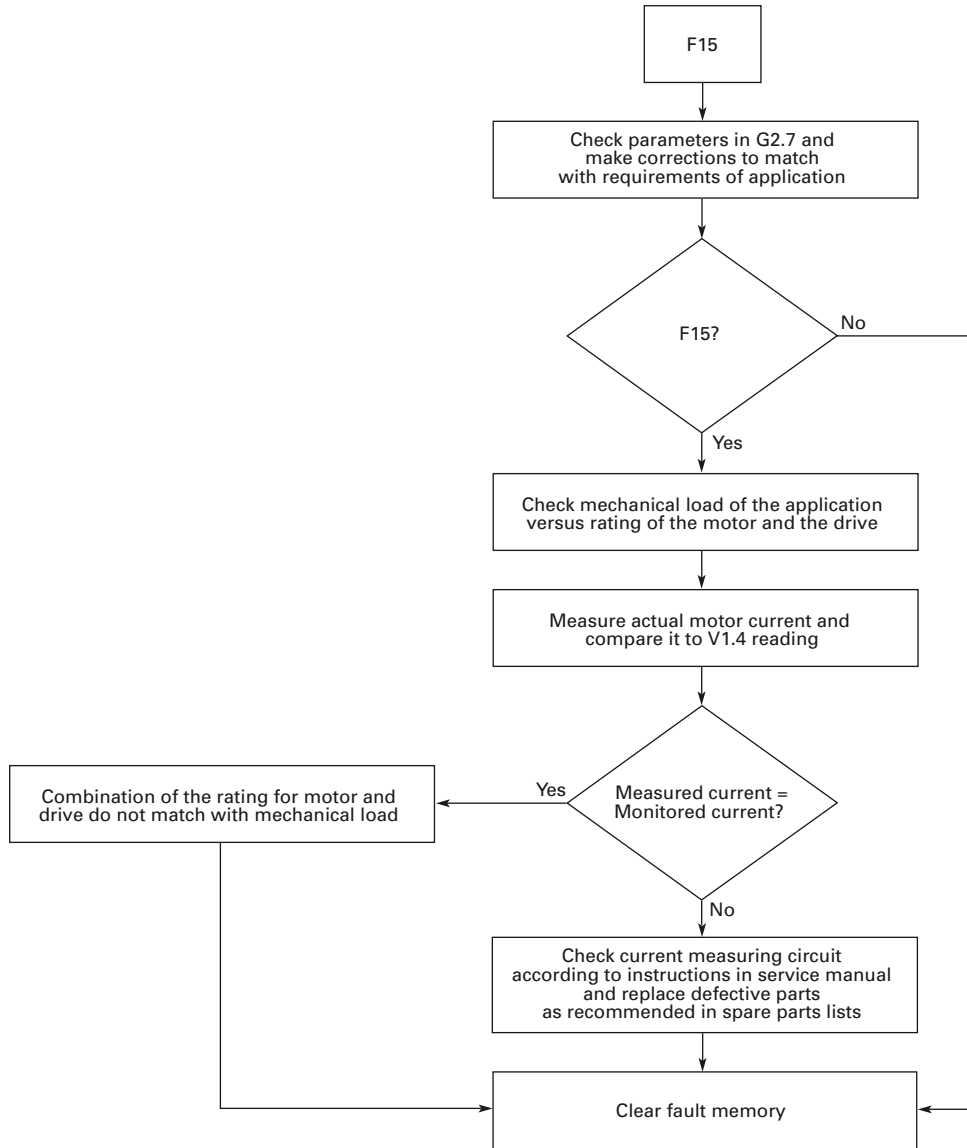

F16—Motor Over Temperature

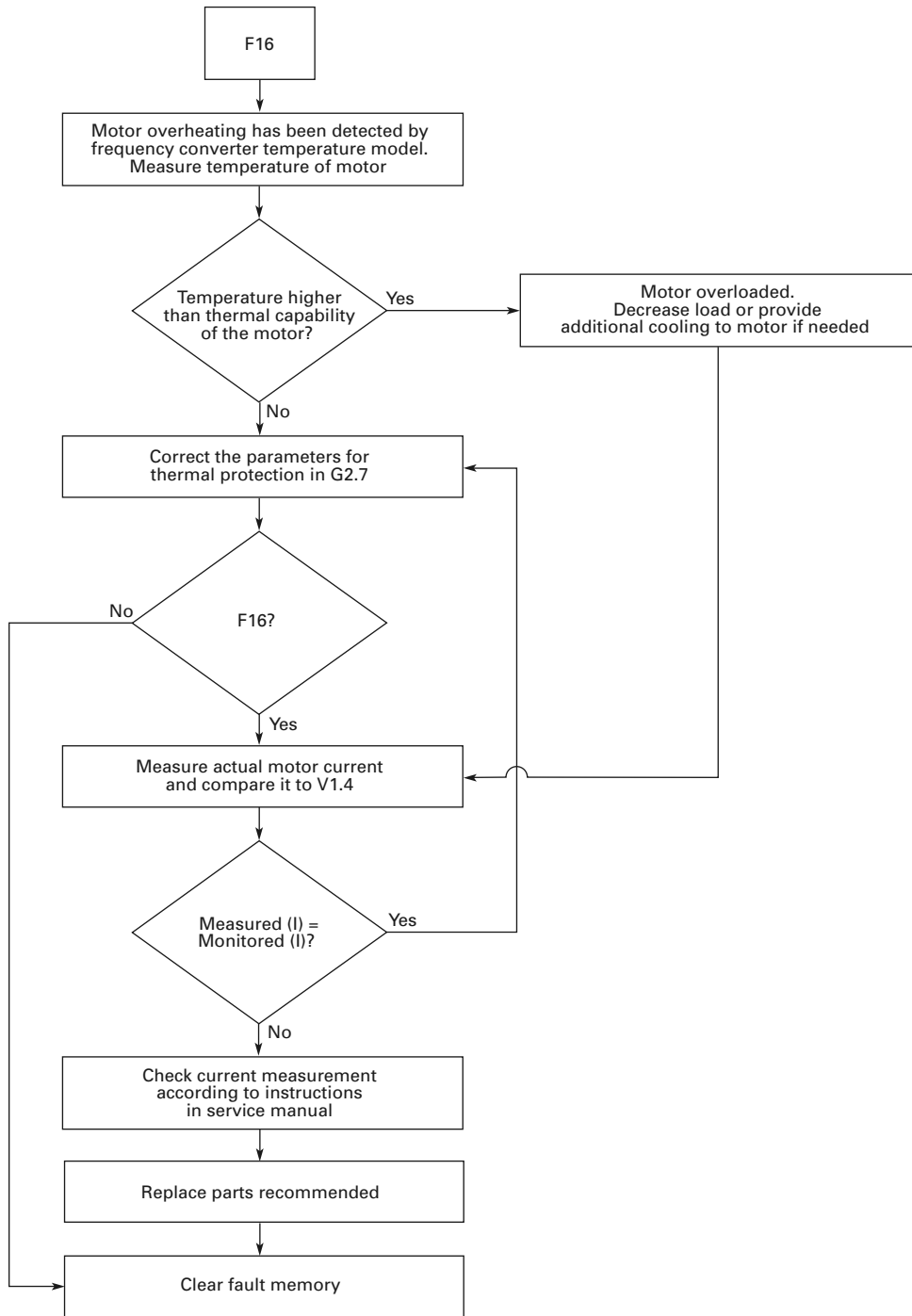

F17—Motor Under Load

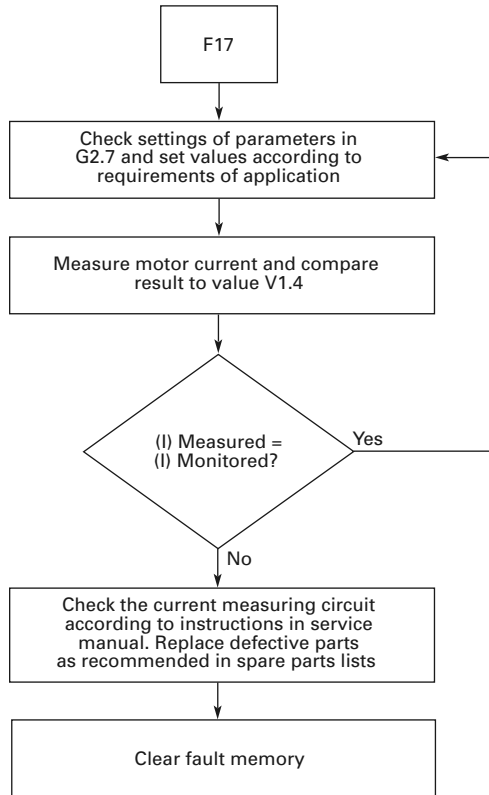

Troubleshooting Charts Using Fault Codes

F22—Param Fault

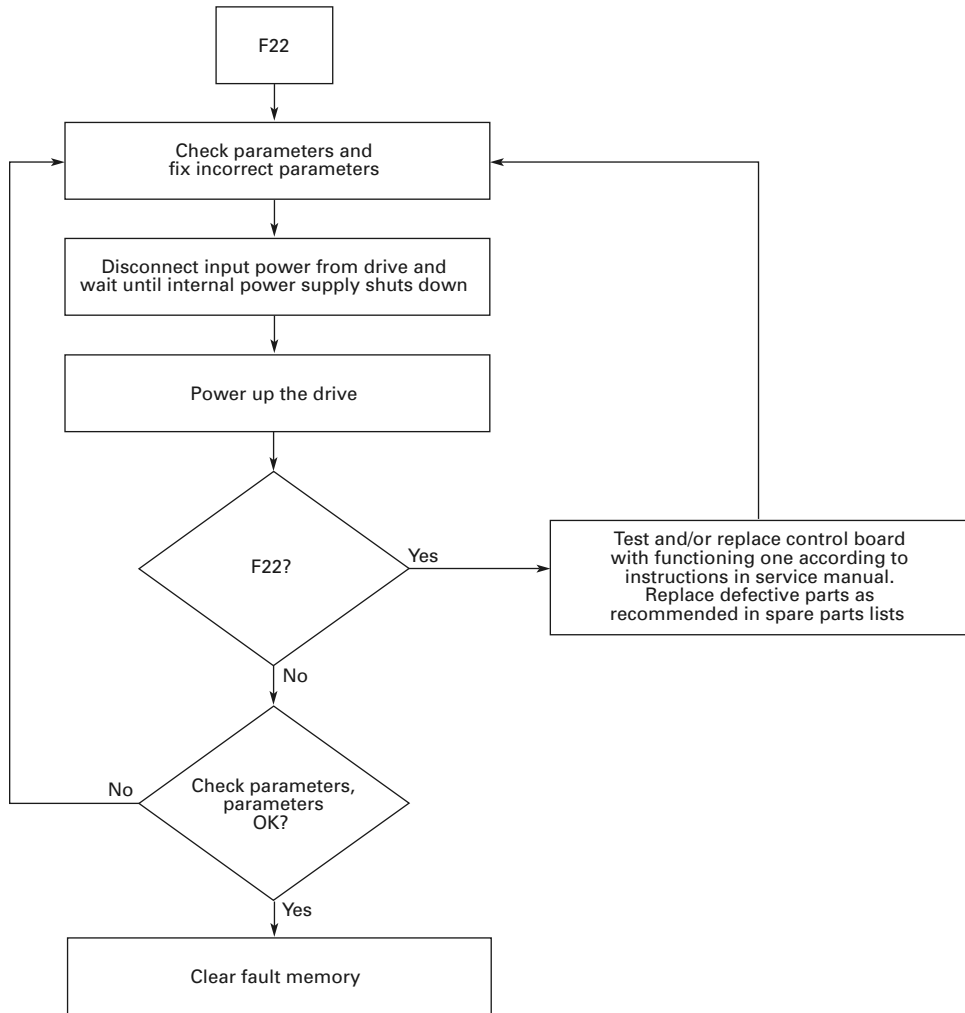

F24—Counter Fault

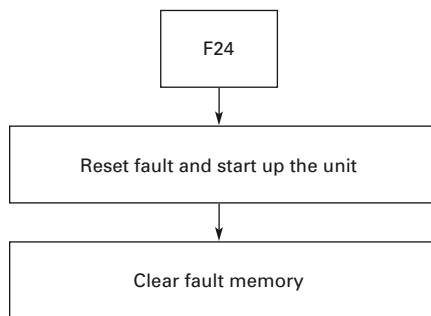

F25—Microprocessor Watchdog Fault

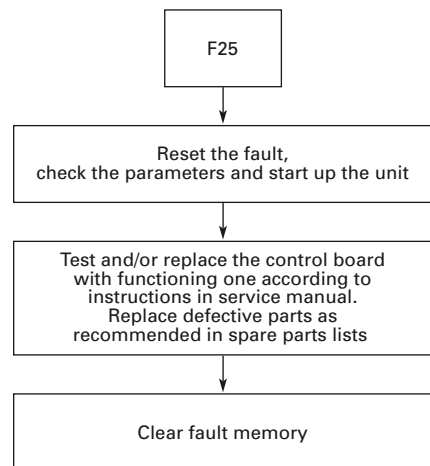

F31—IGBT Temperature (Hardware)

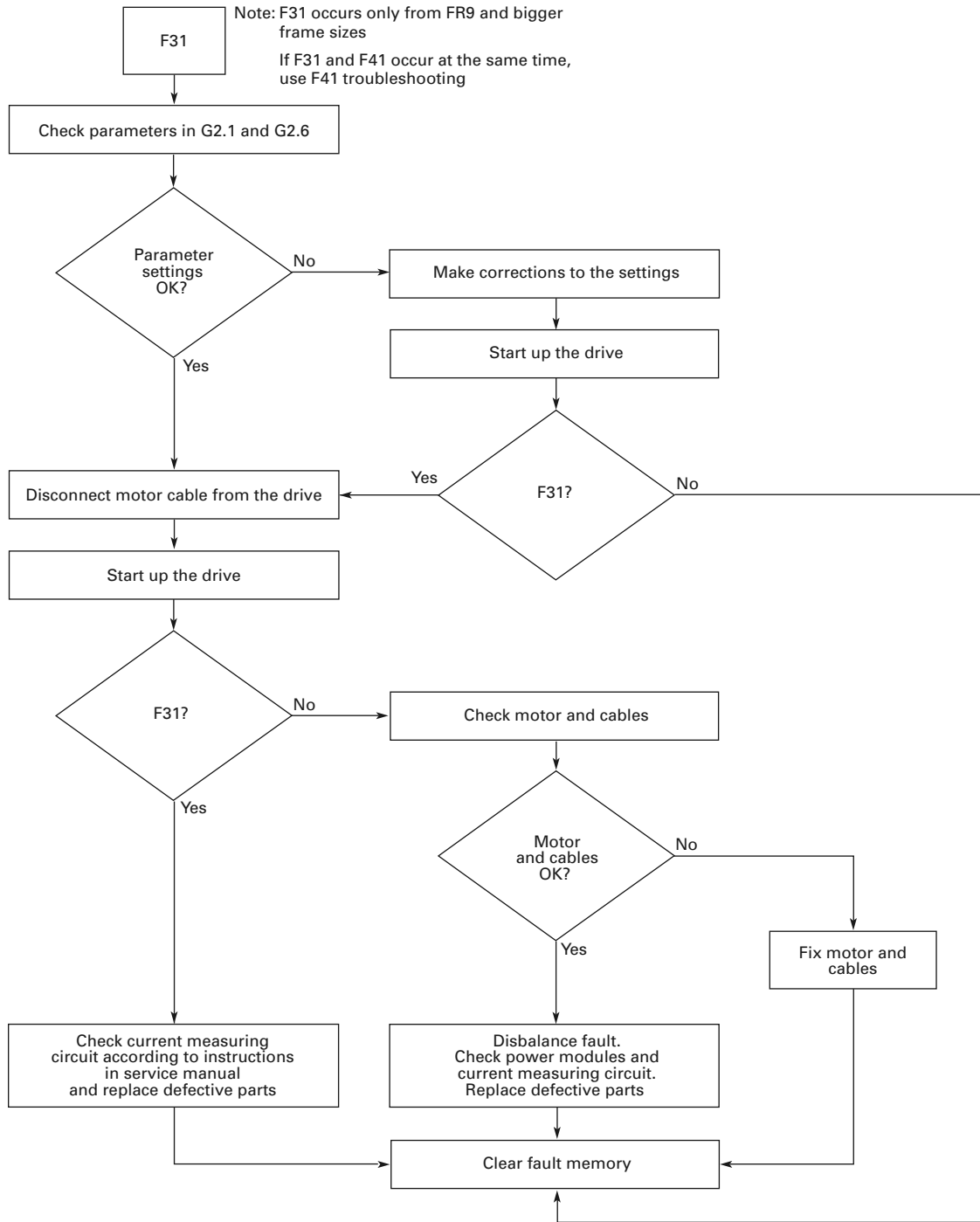

Troubleshooting Charts Using Fault Codes

F32—Fan Cooling

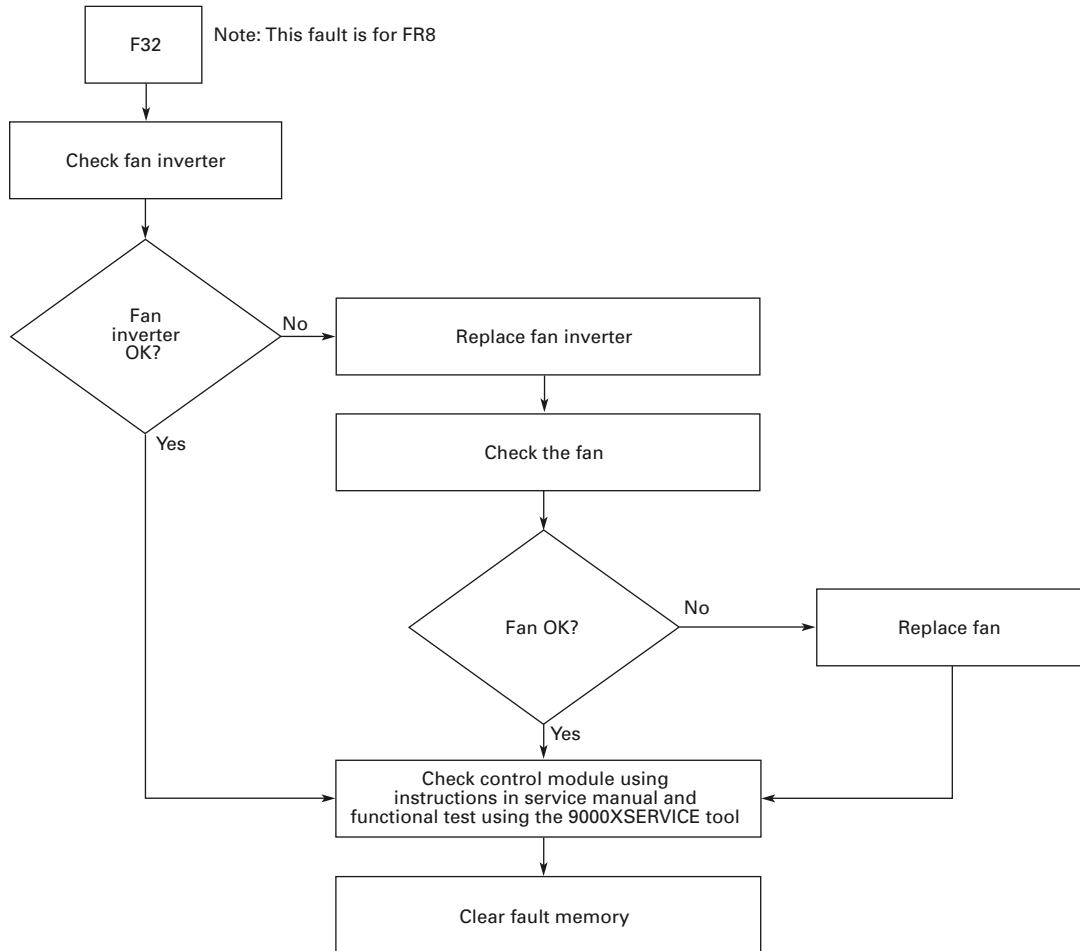

F36—Control Unit

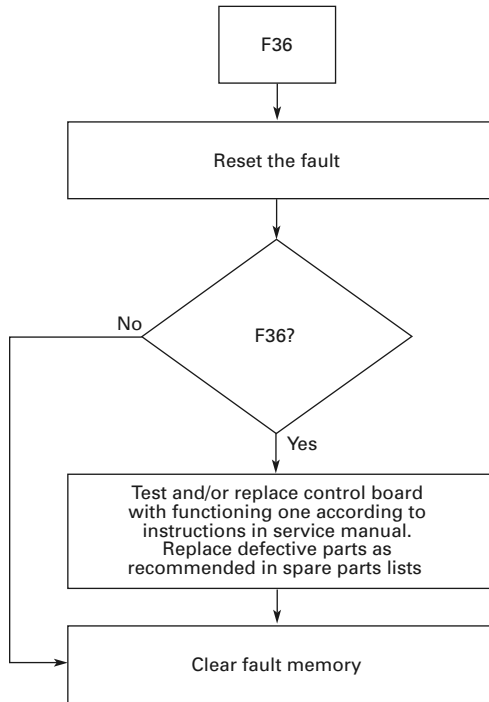

F37—Device Change

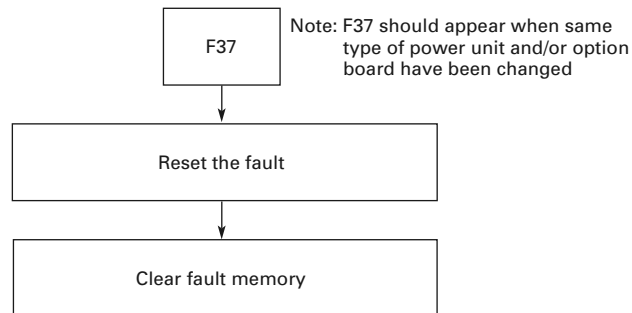

Note: Faulty board is displayed on panel bottom line
 1 = Control card A = Slot A
 2 = Control unit B = Slot B
 3 = Power card C = Slot C
 4 = Power unit D = Slot D
 5 = Adapter card E = Slot E

F38—Device Added (Indication Only)

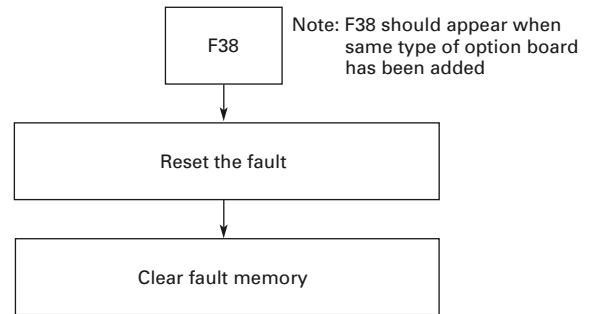

Note: Faulty board is displayed on panel bottom line
 1 = Control card A = Slot A
 2 = Control unit B = Slot B
 5 = Adapter card C = Slot C
 D = Slot D
 E = Slot E

F39—Device Removed

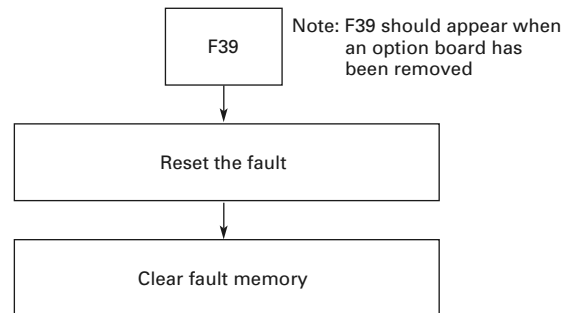

Note: Faulty board is displayed on panel bottom line
 A = Slot A
 B = Slot B
 C = Slot C
 D = Slot D
 E = Slot E
 5 = Adapter card

Troubleshooting Charts Using Fault Codes

F40—Device Unknown

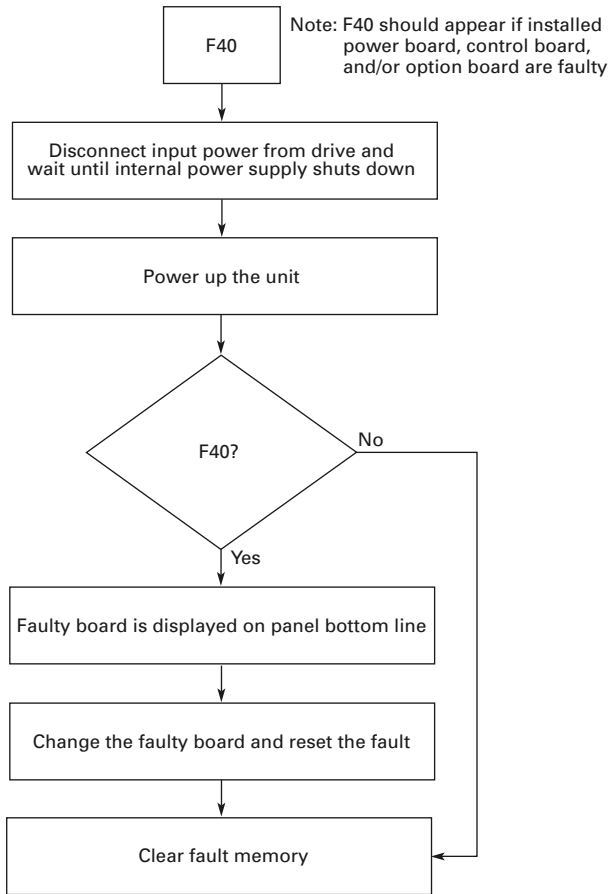

Note: Faulty board is displayed on panel bottom line

- | | |
|------------------|------------|
| 1 = Control card | A = Slot A |
| 2 = Control unit | B = Slot B |
| 3 = Power card | C = Slot C |
| 4 = Power unit | D = Slot D |
| 5 = Adapter card | E = Slot E |

F41—IGBT Temperature

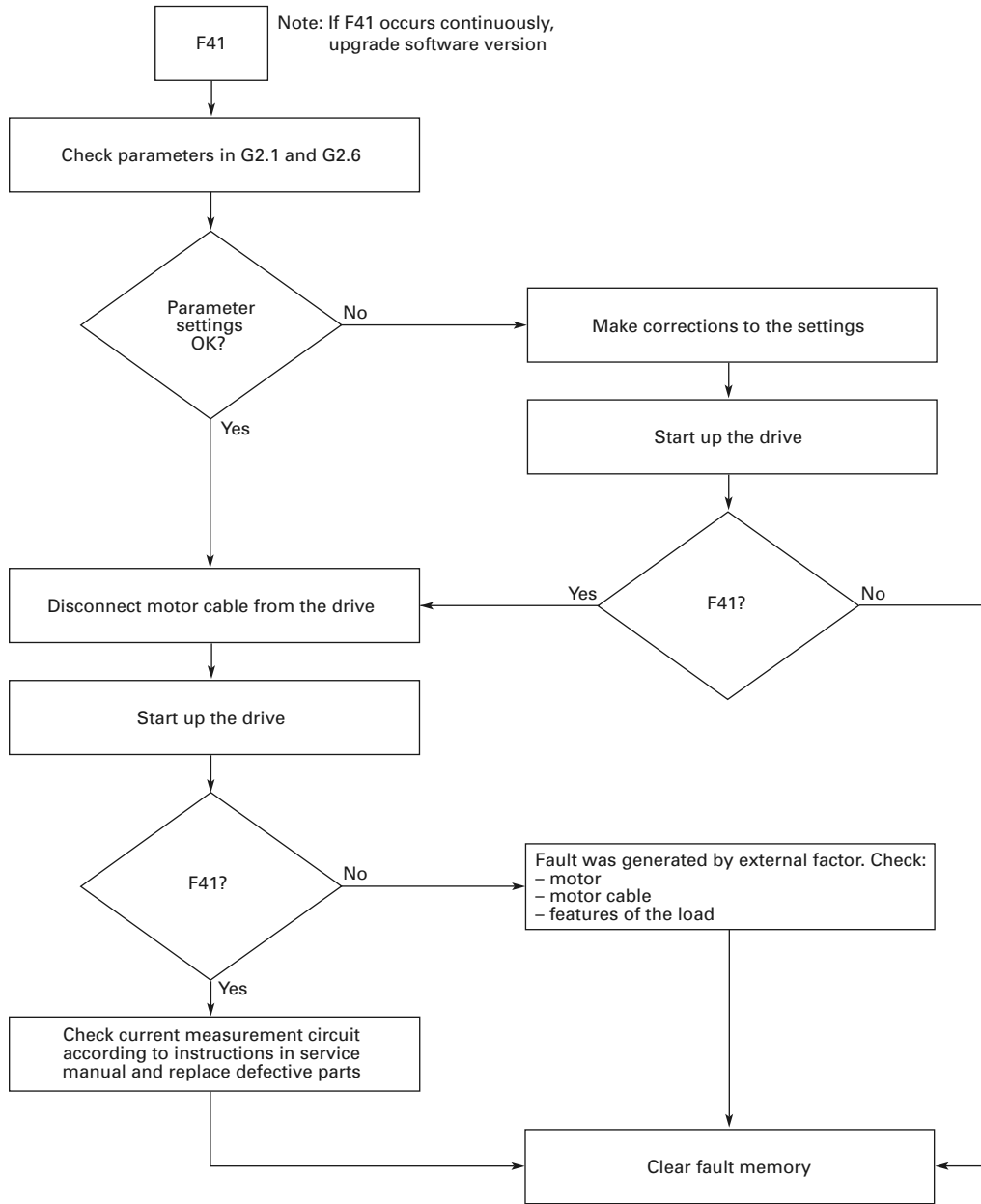

F42—Brake Resistor Over Temperature

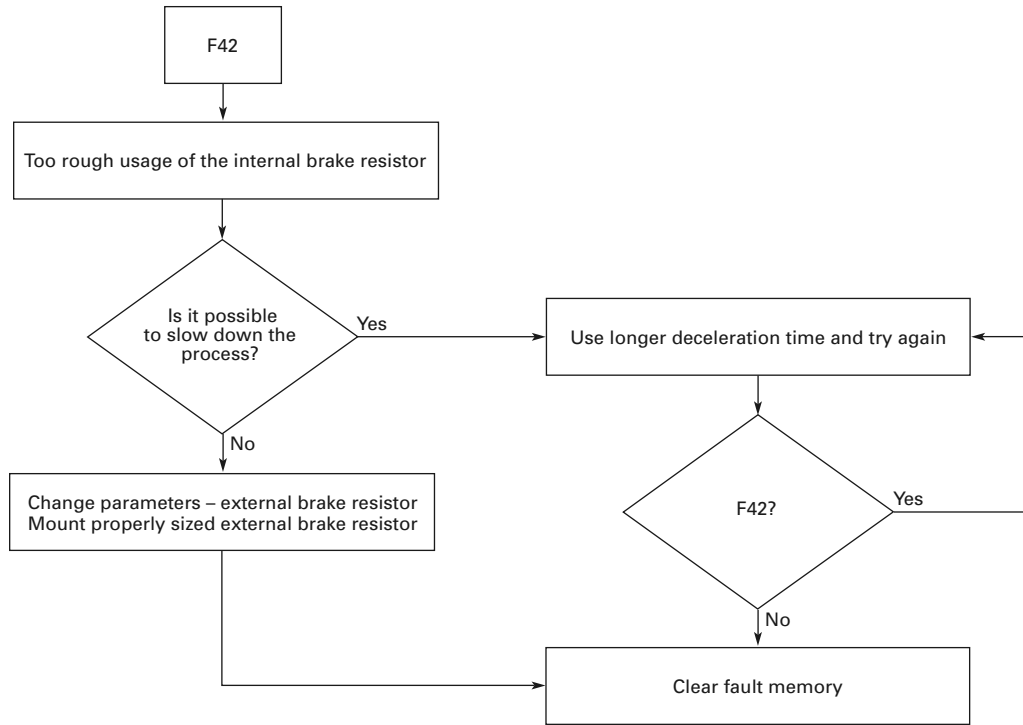

F44—DevParChange

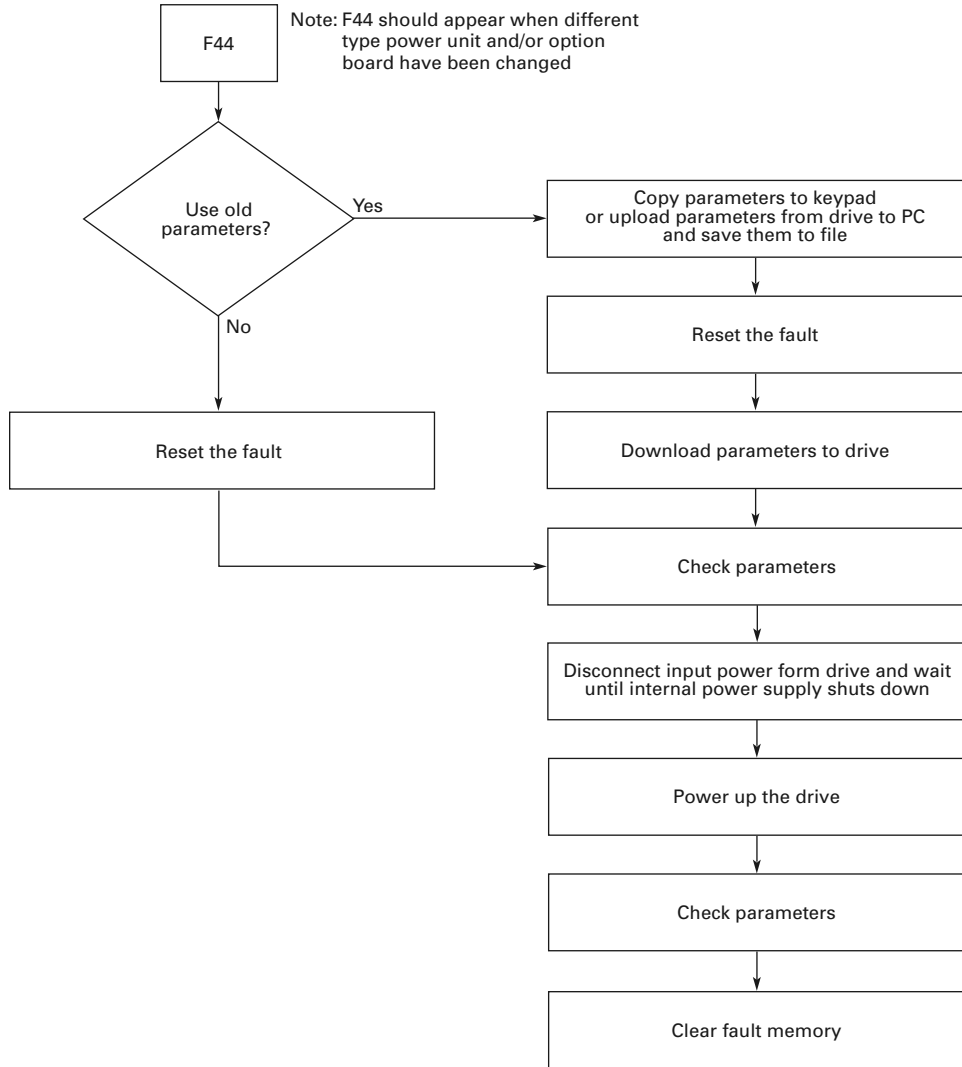

Note: Faulty board is displayed on panel bottom line

- A = Slot A
- B = Slot B
- C = Slot C
- D = Slot D
- E = Slot E
- 4 = Power unit

Troubleshooting Charts Using Fault Codes

F45—DevParAdded

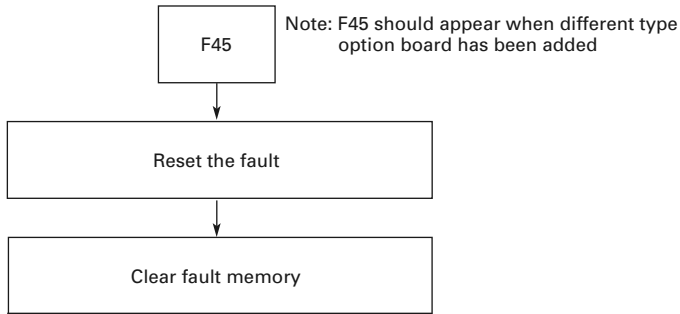

Note: Faulty board is displayed on panel bottom line

A = Slot A D = Slot D
B = Slot B E = Slot E
C = Slot C

F50—Analog Input $I_{IN} < 4 \text{ mA}$

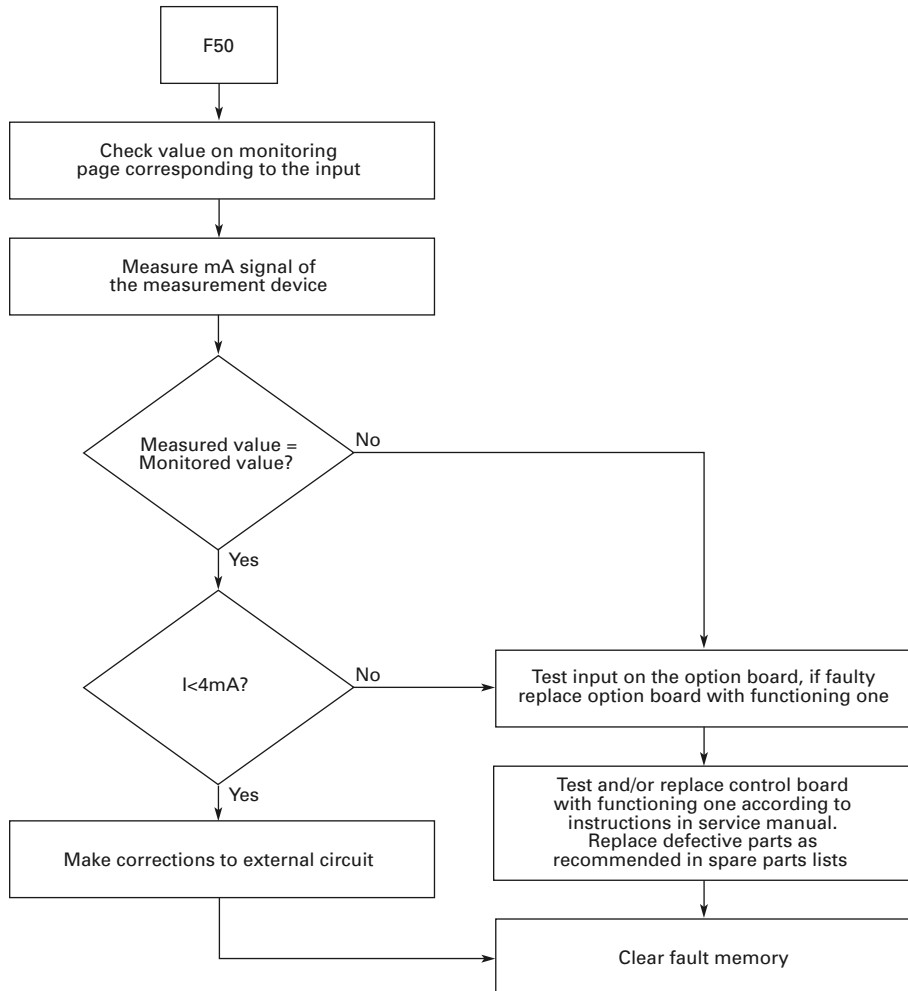

F51—External Fault

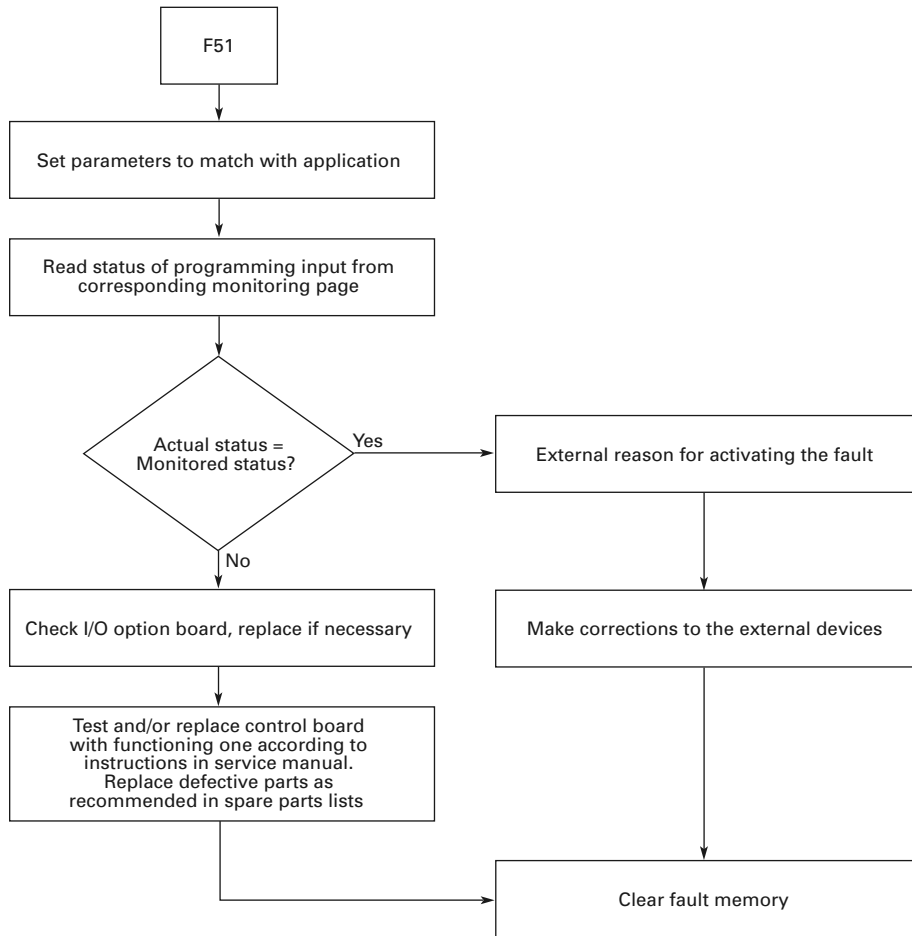

F52—Keypad Communication Fault

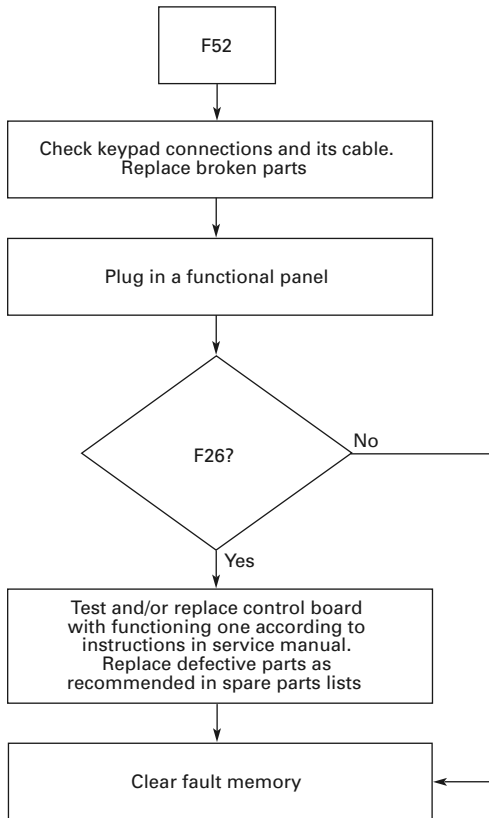

Spare Parts

Series Option Board Kits

The 9000X Series drives can accommodate a wide selection of expander and adapter option boards to customize the drive for your application needs. The drive's control unit is designed to accept a total of five option boards (see figure below).

The 9000X Series factory-installed standard board configuration includes an A9 I/O board and an A2 relay output board, which are installed in slots A and B.

9000X Series Option Boards

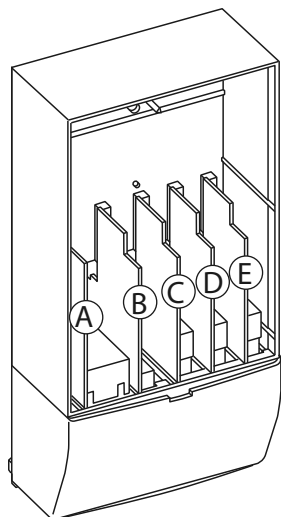

Option Board Kits

Option Kit Description ^①	Allowed Slot Locations ^②	Field Installed Catalog Number	Factory Installed Option Designator	9000X Ready Programs						
				Basic	Local/Remote	Standard	MSS	PID	Multi-P.	PFC
Standard I/O Cards (See figure above)										
2 RO (NC/NO)	B	OPTA2	—	X	X	X	X	X	X	X
6 DI, 1 DO, 2 AI, 1AO, 1 +10 Vdc ref, 2 ext +24 Vdc/EXT +24 Vdc	A	OPTA9	—	X	X	X	X	X	X	X
Extended I/O Card Options										
2 RO, therm	B	OPTA3	A3	—	X	X	X	X	X	X
Encoder low volt +5V/15V/24V ^③	C	OPTA4	A4	—	X	X	X	X	X	X
Encoder high volt +15V/24V ^③	C	OPTA5	A5	—	X	X	X	X	X	X
Double encoder ^③	C	OPTA7	A7	X	X	X	X	X	X	X
6 DI, 1 DO, 2 AI, 1 AO	A	OPTA8	A8	—	X	X	X	X	X	X
3 DI (encoder 10–24V), out +15V/+24V, 2 DO (pulse+direction) ^③	C	OPTAE	AE	X	X	X	X	X	X	X
Safe disable ^③		OPTAF								

Notes

^① AI = Analog Input; AO = Analog Output, DI = Digital Input, DO = Digital Output, RO = Relay Output.

^② Option card must be installed in one of the slots listed for that card. Slot indicated in bold is the preferred location.

^③ SPX drives only.

Spare Parts

Option Board Kits, continued

Option Kit Description ^①	Allowed Slot Locations ^②	Field Installed	Factory Installed	9000X Ready Programs						
		Catalog Number	Option Designator	Basic	Local/Remote	Standard	MSS	PID	Multi-P.	PFC
Extended I/O Card Options (Continued)										
6 DI, 1 ext +24 Vdc/EXT +24 Vdc	B, C, D , E	OPTB1	B1	—	—	—	—	—	X	X
1 RO (NC/NO), 1 RO (NO), 1 therm	B, C, D , E	OPTB2	B2	—	—	—	—	—	X	X
1 AI (mA isolated), 2 AO (mA isolated), 1 ext +24 Vdc/EXT +24 Vdc	B, C, D , E	OPTB4	B4	—	X	X	X	X	X	X
3 RO (NO)	B, C, D , E	OPTB5	B5	—	—	—	—	—	X	X
1 ext +24 Vdc/EXT +24 Vdc, 3 Pt100	B, C, D , E	OPTB8	B8	—	—	—	—	—	—	—
1 RO (NO), 5 DI 42 – 240 Vac Input	B, C, D , E	OPTB9	B9	—	—	—	—	—	X	X
SPI, absolute encoder ^③	C	OPTBB	BB	—	—	—	—	—	—	—
Communication Cards										
Modbus® ^④	D, E	OPTC2	C2	X	X	X	X	X	X	X
Johnson Controls® N2 ^④	D, E	OPTC2	CA	—	—	—	—	—	—	—
Modbus TCP	D, E	OPTCI	CI	X	X	X	X	X	X	X
BACnet®	D, E	OPTCJ	CJ	X	X	X	X	X	X	X
EtherNet/IP	D, E	OPTCQ	CQ	X	X	X	X	X	X	X
PROFIBUS® DP	D, E	OPTC3	C3	X	X	X	X	X	X	X
LonWorks®	D, E	OPTC4	C4	X	X	X	X	X	X	X
PROFIBUS DP (D9 connector)	D, E	OPTC5	C5	X	X	X	X	X	X	X
CANopen (slave)	D, E	OPTC6	C6	X	X	X	X	X	X	X
DeviceNet™	D, E	OPTC7	C7	X	X	X	X	X	X	X
Modbus (D9 type connector)	D, E	OPTC8	C8	X	X	X	X	X	X	X
Adapter ^③	D, E	OPTD1	D1	X	X	X	X	X	X	X
Adapter ^③	D, E	OPTD2	D2	X	X	X	X	X	X	X
RS-232 with D9 connection	D, E	OPTD3	D3	X	X	X	X	X	X	X
Keypad										
9000X Series local/remote keypad (replacement keypad)	—	KEYPAD-LOC/REM	—	—	—	—	—	—	—	—
9000X Series remote mount keypad unit (keypad not included, includes 10 ft cable, keypad holder, mounting hardware)	—	OPTRMT-KIT-9000X	—	—	—	—	—	—	—	—
9000X Series RS-232 cable, 13 ft	—	PP00104	—	—	—	—	—	—	—	—

Notes

- ① AI = Analog Input; AO = Analog Output, DI = Digital Input, DO = Digital Output, RO = Relay Output.
- ② Option card must be installed in one of the slots listed for that card. Slot indicated in bold is the preferred location.
- ③ SPX drives only.
- ④ OPTC2 is a multi-protocol option card.

Johnson Controls Metasys N2 Network Communications

The OPTC2 fieldbus board provides communication between the 9000X drive and a Johnson Controls Metasys™ N2 network. With this connection, the drive can be controlled, monitored, and programmed from the Metasys system. The N2 fieldbus is available as a factory-installed option and as a field-installable kit.

Modbus/TCP Network Communications

The Modbus/TCP Network Card OPTCI is used for connecting the 9000X drive to Ethernet networks using Modbus protocol. It includes an RJ-45 pluggable connector. This interface provides a selection of standard and custom register values to communicate drive parameters. The board supports 10 Mbps and 100 Mbps communication speeds. The IP address of the board is configurable over Ethernet using a supplied software tool.

BACnet Network Communications

The BACnet Network Card OPTCJ is used for connecting the 9000X drive to BACnet networks. It includes a 5.08 mm pluggable connector. Data transfer is Master-Slave/Token Passing (MS/TP) RS-485. This interface uses a collection of 30 Binary Value Objects (BVOs) and 35 Analog Value Objects (AVOs) to communicate drive parameters. The card supports 9.6, 19.2, and 38.4 Kbaud communication speeds and supports network addresses 1–127.

EtherNet/IP Network Communications

The EtherNet/IP Network Card OPTCK is used for connecting the 9000X drive to Ethernet/Industrial Protocol networks. It includes an RJ-45 pluggable connector. The interface uses CIP objects to communicate drive parameters (CIP is “Common Industrial Protocol,” the same protocol used by DeviceNet). The board supports 10 Mbps and 100 Mbps communication speeds. The IP address of the board is configurable by Static, BOOTP, and DHCP methods.

Modbus RTU Network Communications

The Modbus Network Card OPTC2 is used for connecting the 9000X drive as a slave on a Modbus network. The interface is connected by a 9-pin DSUB connector (female) and the baud rate ranges from 300 to 19200 baud. Other communication parameters include an address range from 1 to 247; a parity of None, Odd or Even; and the stop bit is 1.

PROFIBUS Network Communications

The PROFIBUS Network Card OPTC3 is used for connecting the 9000X drive as a slave on a PROFIBUS-DP network. The interface is connected by a 9-pin DSUB connector (female). The baud rates range from 9.6K baud to 12M baud, and the addresses range from 1 to 127.

LonWorks Network Communications

The LonWorks Network Card OPTC4 is used for connecting the 9000X drive on a LonWorks network. This interface uses Standard Network Variable Types (SNVT) as data types. The channel connection is achieved using a FTT-10A Free Topology transceiver via a single twisted transfer cable. The communication speed with LonWorks is 78 kBits/s.

CANopen (Slave) Communications

The CANopen (Slave) Network Card OPTC6 is used for connecting the 9000X drive to a host system. According to ISO11898 standard cables to be chosen for CANbus should have a nominal impedance of 120 ohms, and specific line delay of nominal 5 ns/m. 120 ohms line termination resistors required for installation.

DeviceNet Network Communications

The DeviceNet Network Card OPTC7 is used for connecting the 9000X drive on a DeviceNet Network. It includes a 5.08 mm pluggable connector. Transfer method is via CAN using a two-wire twisted shielded cable with two-wire bus power cable and drain. The baud rates used for communication include 125K baud, 250K baud, and 500K baud.

Spare Parts

Drive Options

Control Panel Options

Control Panel Factory Options

Description	Factory Installed Option Code	Field Installed NEMA Type 1 Catalog Number
Local/Remote Keypad SVX9000 Control Panel —This option is standard on all drives and consists of an RS-232 connection, backlit alphanumeric LCD display with nine indicators for the RUN status and two indicators for the control source. The nine pushbuttons on the panel are used for panel programming and monitoring of all 9000X parameters. The panel is detachable and isolated from the input line potential. Include LOC/REM key to choose control location.	A	KEYPAD-LOC/REM
Keypad Remote Mounting Kit —This option is used to remote mount the 9000X keypad. The footprint is compatible to the SV9000 remote mount kit. Includes 10 ft cable, keypad holder, and mounting hardware.	—	OPTRMT-KIT-9000X
Keypad Blank —9000X Series select keypad for use with special and custom applications.	—	KEYPAD-BLANK
9000X Drive —A PC-based tool for controlling and monitoring of the 9000X. Features include: loading parameters that can be saved to a file or printed, setting references, starting and stopping the motor, monitoring signals in graphical or text form, and real-time display. To avoid damage to the drive or computer, SVDrivecable must be used.	—	9000XDRIVE
SVDrivecable —6 ft (1.8m) RS-232 cable (22 gauge) with a 7-pin connector on each end. Should be used in conjunction with the 9000X drive option to avoid damage to the drive or the computer. The same cable can be used for downloading specialized applications to the drive.	—	SVDRIVECABLE

Spare Units and Replacement Parts for 9000X Drives

9000X Spare Units

Description	Catalog Number
Control Unit—Includes the control board, blue base housing, installed 9000X software program and blue flip cover. Does not include any OPT boards or keypad. See Page 110 for standard and option boards and keypad.	CSBS0000000000 (for SVX)
	CPBS0000000000 (for SPX)

208–240V

Replacement Parts—9000X Drives, 208–240V

Frame:	4		5		6		7		8		Catalog Number						
hp (I _H):	3/4	1	1-1/2	2	3	5 ^①	5	7-1/2	10	15		20	25	30	40	50	60
Control Board																	
	1	1	1	1	1	1	1	1	1	1	1	1	1	1	1	1	VB00252 (for SVX)
	1	1	1	1	1	1	1	1	1	1	1	1	1	1	1	1	VB00561 (for SPX)
Power Boards																	
	1																VB00308-0004-2
		1															VB00308-0007-2
			1														VB00308-0008-2
				1													VB00310-0011-2
					1												VB00310-0012-2
						1											VB00313-0017-2
							1										VB00313-0025-2
								1									VB00313-0031-2
									1								VB00316-0048-2
										1							VB00316-0061-2
											1						VB00319-0075-2
												1					VB00319-0088-2
													1				VB00319-0114-2
														1			VB00322-0140-2
															1		VB00322-0170-2
																1	VB00322-0205-2
Electrolytic Capacitors																	
	2	2	2														PP01000
				2	2												PP01001
						2	2										PP01002
								2									PP01003
									2	2							PP01004
											2	2	2	4	4		PP01005
																4	PP01099

Note

① 5 hp I_L only; has no corresponding I_H rated hp rating.

Spare Parts

Replacement Parts—9000X Drives, 208–240V, continued

Frame:	4			5			6			7			8			Catalog Number	
hp (I _H):	3/4	1	1-1/2	2	3	5 ^①	5	7-1/2	10	15	20	25	30	40	50		60
Cooling Fans																	
	1	1	1	1	1												PP01060
						1	1	1									PP01061
									1	1							PP01062
											1	1	1				PP01063
														1	1	1	PP01123 ^②
	1	1	1	1	1												PP01086
						1	1	1	1	1							PP01088
											1	1	1				PP01049
														1	2	2	CP01180
														1	1	1	PP08037
IGBT Modules																	
	1	1															CP01304
			1														CP01305
				1	1	1											CP01306
							1										CP01307
								1									CP01308
									1								PP01022
										1							PP01023
											1						PP01024
												1					PP01025
													1				PP01029
														1			PP01026
															1	1	PP01027
Choppers/Rectifiers																	
									1								CP01367
										1							CP01368
Diode/Thyristor Modules																	
											3	3	3				PP01035
														3	3	3	CP01268
Rectifying Boards																	
										1	1	1					VB00242
														1	1	1	VB00227

Notes

- ① 5 hp I_L only; has no corresponding I_H rated hp rating.
- ② PP00061 capacitor not included in main fan; please order separately.

FR4–FR9, 380–500V

Replacement Parts—FR4–FR9 9000X Drives, 380–500V

Frame:	4				5				6				7				8				9				Catalog Number
hp (I _H):	1	1-1/2	2	3	5	7-1/2 ①	7-1/2	10	15	20	25	30	40	50	60	75	100	125	150	200					
Control Board																									
	1	1	1	1	1	1	1	1	1	1	1	1	1	1	1	1	1	1	1	1	1	VB00252 (for SVX)			
	1	1	1	1	1	1	1	1	1	1	1	1	1	1	1	1	1	1	1	1	1	VB00561 (for SPX)			
Power Boards																									
	1																					VB00208-0003-5			
	1																					VB00208-0004-5			
		1																				VB00208-0005-5			
			1																			VB00208-0007-5			
				1																		VB00208-0009-5			
					1																	VB00210-0012-5			
						1																VB00213-0016-5			
							1															VB00213-0022-5			
								1														VB00213-0031-5			
									1													VB00216-0038-5			
										1												VB00216-0045-5			
											1											VB00216-0061-5			
												1										VB00219-0072-5			
													1									VB00219-0087-5			
														1								VB00219-0105-5			
															1							VB00236-0140-5			
																1						VB00236-0168-5			
																	1					VB00236-0205-5			
Electrolytic Capacitors																									
	2	2	2	2																		PP01000			
				2	2																	PP01001			
						2	2															PP01002			
								2														PP01003			
									2	2	2											PP01004			
													2	2	2	4	4	4	8	8		PP01005			
Cooling Fans																									
	1	1	1	1	1																	PP01060			
						1	1	1														PP01061			
									1	1	1											PP01062			
												1	1	1								PP01063			
															1	1	1					PP01123 ②			
																		1	1			PP01080 ③			

Notes

- ① I_L only; has no corresponding I_H rated hp rating.
- ② PP00061 capacitor not included in main fan; please order separately.
- ③ PP00011 capacitor not included in main fan; please order separately.

Spare Parts

Replacement Parts—FR4–FR9 9000X Drives, 380–500V, continued

Frame:	4					5			6				7				8				9				Catalog Number
hp (I _H):	1	1-1/2	2	3	5	7-1/2 ^①	7-1/2	10	15	20	25	30	40	50	60	75	100	125	150	200					
Cooling Fans, continued																									
	1	1	1	1	1	1																PP01086			
							1	1	1													PP01088			
										1	1	1	1	1	1							PP01049			
																1	1	1				CP01180			
																				1 ^②	2	PP01068			
																				1	1	PP09051			
IGBT Modules																									
	1	1	1																			CP01304			
				1	1																	CP01305			
					1	1																CP01306			
						1	1															CP01307			
							1															CP01308			
								1														PP01022			
									1	1												PP01023			
											1											PP01024			
												1										PP01025			
													1									PP01029			
															1							PP01026			
																1	1					PP01027			
Chopper/Rectifiers																									
									1	1												CP01367			
											1											CP01368			
Diode/Thyristor Modules																									
													3	3	3							PP01035			
																3	3	3				CP01268			
																			3	3		PP01037			
Rectifying Boards																									
												1	1	1								VB00242			
															1	1	1					VB00227			
																			1	1		VB00459			
Rectifying Module Sub-Assembly																									
																			1	1		FR09810			
Power Module Sub-Assemblies																									
																				1		FR09-150-4-ANS ^③			
																				1		FR09-200-4-ANS ^③			

Notes

- ① I_L only; has no corresponding I_H rated hp rating.
- ② For FR9 NEMA Type 12 you need two PP01068 internal fans.
- ③ See **Page 124** for details.

FR10–FR12, 380–500V

Replacement Parts—FR10–FR12 9000X Drives, 380–500V

Frame:	10		11			12				Catalog Number
hp (H):	250	300	350	400	500	550	600	650	700	
Control Board										
	1	1	1	1	1	1	1	1	1	VB00561
Shunt Boards										
	6									VB00537
		6								VB00497
			6				12	12	12	VB00498
				9						VB00538
					9					VB00513
						9				VB00514
Driver Boards										
				3	3	3				VB00489
	1	1	1				2	2	2	VB00487
Driver Adapter Board										
	1	1	1				2	2	2	VB00330
ASIC Board										
	1	1	1	1	1	1	2	2	2	VB00451
Feedback Interface Board										
							2	2	2	VB00448
Star Coupler Board										
							1	1	1	VB00336
Power Modules										
	1	1	1	2	2	2	2	2	2	FR10820 ①
	2	2	2							FR10828
	1									FR10-250-4-ANS ②
		1								FR10-300-4-ANS ②
			1				2	2	2	FR10-350-4-ANS ②
				3						FR11-400-4-ANS ②
					3					FR11-500-4-ANS ②
						3				FR11-550-4-ANS ②

Notes

① Rectifying board not included.

② See **Page 124** for details.

Spare Parts

Replacement Parts—FR10–FR12 9000X Drives, 380–500V, continued

Frame:	10		11			12			Catalog Number	
hp (H):	250	300	350	400	500	550	600	650		700
Electrolytic Capacitors										
	2	2	2	3	3	3	4	4	4	PP00060
	12	12	12	18	18	18	24	24	24	PP01005
Fuses										
	1	1	1	1	1	1	2	2	2	PP01094
	2	2	2	2	2	2	4	4	4	PP01095
Cooling Fans and Isolation Transformers										
	2	2	2	3	3	3	4	4	4	VB00299
	2	2	2	3	3	3	4	4	4	PP01080 ^①
	2	2	2				4	4	4	PP01068
	1	1	1	1	1	1	2	2	2	PP01096
	1	1	1				2	2	2	FR10844
	1	1	1	3	3	3	2	2	2	FR10845
	1	1	1				2	2	2	FR10846
	1	1	1	3	3	3	2	2	2	FR10847
Rectifying Board										
	1	1	1	2	2	2	2	2	2	VB00459

Note

① PP00060 capacitor not included in main fan; please order separately.

FR6–FR9, 525–690V

Replacement Parts—FR6–FR9 9000X Drives, 525–690V

Frame:	6				7					8				9				Catalog Number		
hp (I _H):	2	3	5 ^①	5	7-1/2	10	15	20	25	30	40	50	60	75	100	125	150		200 ^①	
Control Board																				
	1	1	1	1	1	1	1	1	1	1	1	1	1	1	1	1	1	1	1	VB00252 (for SVX)
	1	1	1	1	1	1	1	1	1	1	1	1	1	1	1	1	1	1	1	VB00561 (for SPX)
Driver Board																				
	1																			VB00404-0004-6
		1																		VB00404-0005-6
			1																	VB00404-0007-6
				1																VB00404-0010-6
					1															VB00404-0013-6
						1														VB00404-0018-6
							1													VB00404-0022-6
								1												VB00404-0027-6
									1											VB00404-0034-6
Power Boards																				
	1	1	1	1	1	1	1	1	1											VB00414
										1										VB00419-0041-6
											1									VB00419-0052-6
												1								VB00422-0062-6
													1							VB00422-0080-6
														1						VB00422-0100-6
Power Modules																				
															1					FR09-100-5-ANS ^②
																1				FR09-125-5-ANS ^②
																	1			FR09-150-5-ANS ^②
																		1		FR09-175-5-ANS ^②
Electrolytic Capacitors																				
	2	2	2	2	2	2	2	2	2											PP01093
										2	2	4	4		8	8	8	8		PP01041
														4						PP01040
Fuses																				
											1	1	1	1	1	1	1	1		PP01094
											2	2	2	2	2	2	2	2		PP01095

Notes

- ① I_L only; has no corresponding I_H rated hp rating.
- ② See Page 124 for details.

Spare Parts

Replacement Parts—FR6–FR9 9000X Drives, 525–690V, continued

Frame:	6				7						8		9					Catalog Number	
hp (I _H):	2	3	5 ^①	5	7-1/2	10	15	20	25	30	40	50	60	75	100	125	150		200 ^①
Cooling Fans																			
	1	1	1	1	1														PP01061
						1	1	1	1										PP01062
										1	1								PP01063
												1	1	1					PP01123
	1	1	1	1	1	1	1	1	1	1	1								PP01049
												1	1	1					CP01180
															1	1	1	1 ^②	PP01068
															1	1	1	1	PP01080
Fan Power Supply																			
																1	1	1	VB00299
IGBT Modules																			
	3	3	3	3	3	3	3	3	3										PP01091
										1	1								PP01089
												1	1	1					PP01127
IGBT/Diode (Brake)																			
	1	1	1	1	1	1	1	1	1	1	1	2	2	2	2	2	2	2	PP01040
Diode Module																			
	1	1	1	1	1	1	1	1	1										PP01092
Diode/Thyristor Modules																			
										3	3								PP01071
															3	3	3	3	PP01072
Rectifying Boards																			
										1	1								VB00442
															1	1	1	1	VB00460
Rectifying Module Sub-Assemblies																			
																1	1	1	FR09810
																1	1	1	FR09811

Notes

- ① I_L only; has no corresponding I_H rated hp rating.
- ② For NEMA Type 12, two PP01068 internal fans are needed.

FR10–FR12, 525–690V

Replacement Parts—FR10–FR12 9000X Drives, 525–690V

Frame:	10			11			12			Catalog Number
hp (H):	200	250	300	400	450	500	550	600	700	
Control Board										
	1	1	1	1	1	1	1	1	1	VB00561
Shunt Boards										
	6									VB00545
		6								VB00510
			6				12	12	12	VB00511
				9						VB00546
					9					VB00547
						9				VB00512
Driver Boards										
	1	1	1				2	2	2	VB00487
				3	3	3				VB00489
Driver Adapter Board										
	1	1	1				2	2	2	VB00330
ASIC Board										
	1	1	1	1	1	1	2	2	2	VB00451
Feedback Interface Board										
							2	2	2	VB00448
Star Coupler Board										
							1	1	1	VB00336
Power Modules										
	1	1	1	2	2	2	2	2	2	FR10821 ①
	2	2	2							FR10829
	1									FR10-200-5-ANS ②
		1								FR10-250-5-ANS ②
			1				2	2	2	FR10-300-5-ANS ②
				3						FR11-400-5-ANS ②
					3					FR11-450-5-ANS ②
						3				FR11-500-5-ANS ②
Electrolytic Capacitors										
	2	2	2	3	3	3	4	4	4	PP00060
	12	12	12	18	18	18	24	24	24	PP01099

Notes

- ① Rectifying board not included.
 ② See **Page 124** for details.

Spare Parts

Replacement Parts—FR10–FR12 9000X Drives, 525–690V, continued

Frame:	10			11			12			Catalog Number
hp (I _H):	200	250	300	400	450	500	550	600	700	
Fuses										
1	1	1	1	1	1	1	2	2	2	PP01094
2	2	2	2	2	2	2	4	4	4	PP01095
Cooling Fans and Isolation Transformers										
2	2	2	3	3	3	3	4	4	4	VB00299
2	2	2	3	3	3	3	4	4	4	PP01080 ^①
2	2	2					4	4	4	PP01068
1	1	1	1	1	1	1	2	2	2	PP01096
1	1	1					2	2	2	FR10844
1	1	1	3	3	3	3	2	2	2	FR10845
1	1	1					2	2	2	FR10846
1	1	1	3	3	3	3	2	2	2	FR10847
Fan Power Supply										
							1	1	1	VB00299
Rectifying Boards										
1	1	1	2	2	2	2	2	2	2	VB00460

Power Module

Catalog Number Selection

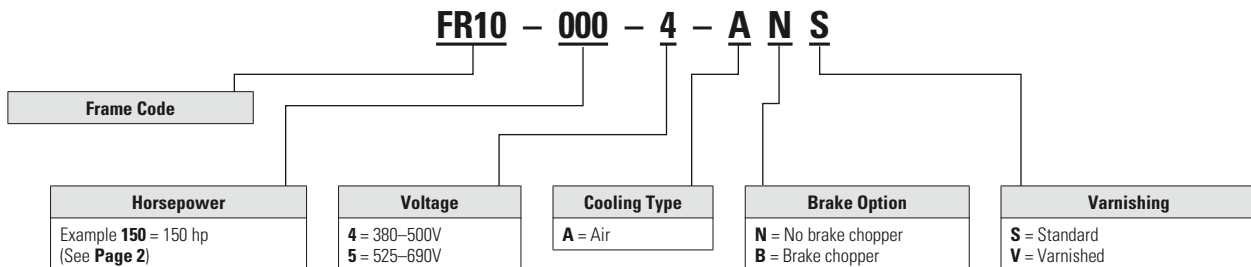

Note

^① PP00060 capacitor not included in main fan; please order separately.

Eaton's Electrical Sector is a global leader in power distribution, power quality, control and automation, and monitoring products. When combined with Eaton's full-scale engineering services, these products provide customer-driven PowerChain™ solutions to serve the power system needs of the data center, industrial, institutional, public sector, utility, commercial, residential, IT, mission critical, alternative energy and OEM markets worldwide.

PowerChain solutions help enterprises achieve sustainable and competitive advantages through proactive management of the power system as a strategic, integrated asset throughout its life cycle, resulting in enhanced safety, greater reliability and energy efficiency. For more information, visit www.eaton.com/electrical.

Eaton Corporation

Electrical Sector
1111 Superior Ave.
Cleveland, OH 44114
United States
877-ETN-CARE (877-386-2273)
Eaton.com

©2011 Eaton Corporation
All Rights Reserved
Printed in USA
Publication No. MN04001004E / Z10673
May 2011



Eaton is a registered trademark of Eaton Corporation. All other trademarks are property of their respective owners.