

## Instruction Leaflet for the TL Torque Limiter

### Description

The TL device line of starting torque limiters is designed for the soft start of three-phase or single-phase motors, i.e., it allows smoother starting of all AC induction motors, thus decreasing shock and vibration problems encountered during across-the-line starts. The device is ramp-up time/torque adjustable from 0.5 to 5 sec./0 to 85% of nominal start torque.

### Installation

#### WARNING

**DO NOT INSTALL OR PERFORM MAINTENANCE ON THIS DEVICE WHILE EQUIPMENT IS ENERGIZED. DEATH OR SEVERE PERSONAL INJURY CAN RESULT FROM CONTACT WITH ENERGIZED EQUIPMENT. VERIFY THAT NO VOLTAGE IS PRESENT BEFORE PROCEEDING WITH INSTALLATION OR MAINTENANCE.**

Only qualified persons, as defined in the National Electric Code, who are familiar with the installation, maintenance and operation of this device and the equipment onto which it is to be installed, as well as applicable local, state and national regulations and industry standards and accepted practices regarding safety of personnel and the equipment safety should be permitted to install, maintain or operate this device. These instructions are provided only as a general guide to such qualified persons and are not all-inclusive. They do not cover every application or circumstance which may arise in the installation, maintenance or operation of this equipment. Users are advised to comply with local, state and national regulations and industry standards and accepted practices regarding safety of personnel and equipment.

#### CAUTION

**REMOVE ALL POWER FROM THE INSTALLATION BEFORE ATTEMPTING TO INSTALL OR REMOVE THIS DEVICE. THIS INCLUDES L1, L2, L3 AS WELL AS TERMINALS 11 and 12.**

### Mounting Guidelines for the TL Torque Limiter

**Important** — The controller is designed for vertical mounting in free air. If the controller is mounted horizontally, the load current must be reduced to 50% of rated current.

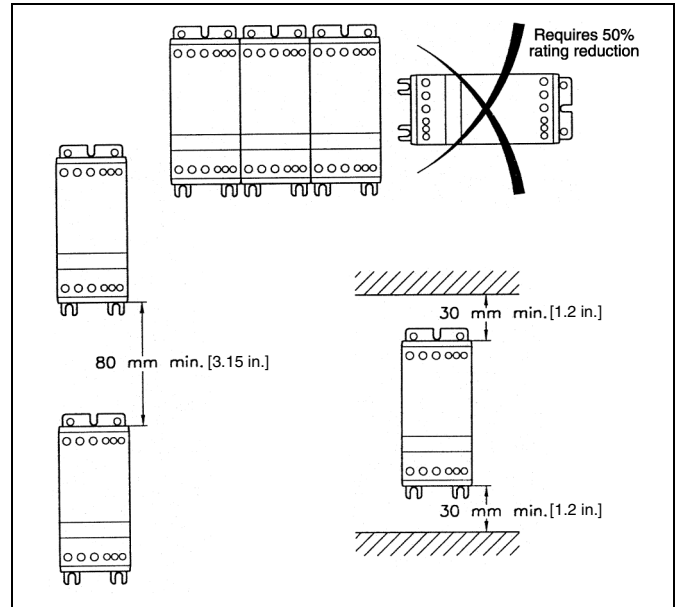
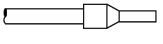
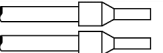

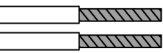
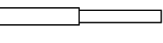
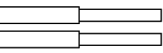

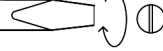

Figure 1. Recommended Mounting Distance

### Wiring Directions

#### IMPORTANT

**When using electrical or pneumatic tools for screw terminals, observe maximum torque limits.**

| 75°C   | AWG (mm <sup>2</sup> )                         | AWG (mm <sup>2</sup> )                  |
|--|--|---|
|  | 18 - 12<br>(0.75 - 4)                          | 20 - 16<br>(0.5 - 1.5)                  |
|  | 2 - 18<br>(2 x 1-1)                            | 2 x 20 - 18<br>(2 x 0.5 - 0.75)         |
|  | 18 - 10<br>(0.75 - 6)                          | 20 - 16<br>(0.5 - 1.5)                  |
|  | 2 x 18 - 14<br>(2 x 0.75 - 2.5)                | 2 x 20 - 16<br>(2 x 0.5 - 1.5)          |
|  | 18 - 10<br>(0.75 - 6)                          | 20 - 16<br>(0.5 - 1.5)                  |
|  | 2 x 18 - 16<br>(2 x 0.75 - 1.5)                | 2 x 20 - 16<br>(2 x 0.5 - 1.5)          |
|  | Posidrive 1<br>0.5 Nm max.<br>[4.4 lb-in max.] | N/A                                     |
|  | 4 mm<br>0.5 Nm max.<br>[4.4 lb-in max.]        | 3 mm<br>0.4 Nm max.<br>[3.5 lb-in max.] |

## Wiring Diagram

### Three-Phase or Single-Phase Soft Start

When the contactor is switched ON, the motor will soft start according to the settings of the torque and time potentiometers. When the contactor is switched OFF, the motor will stop.

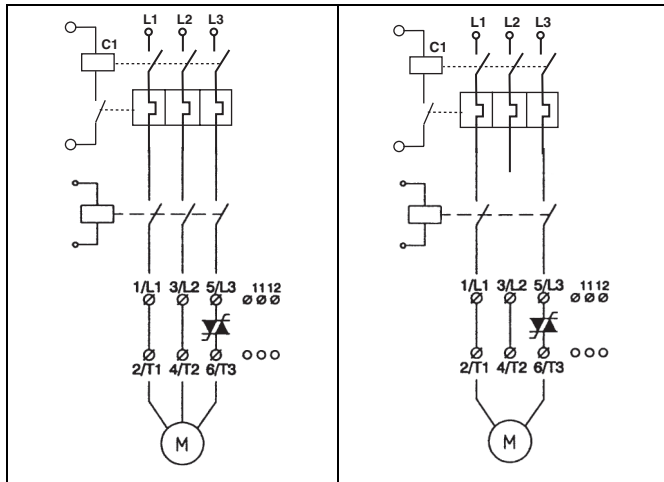

Figure 2. Wiring Diagrams \*

Terminals 11 and 12 have no connection with the internal circuit. Can be used in conjunction with a thermal overload for protection or for other wiring purposes.

**NOTE:** Use thermal overload protection as required by the National Electric Code (NEC).

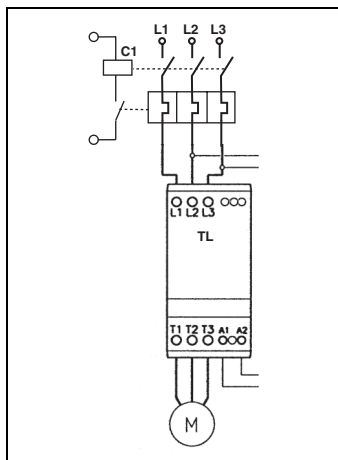

Figure 3. Line Controlled Soft Start

### Non-reversing Start with TL

When the contactor C1 is switched to the ON state, the motor controller will soft start the motor according to the settings of the ramp-up time and initial torque adjustments.

When the contactor C1 is switched to the OFF state, the motor will be switched OFF instantaneously.

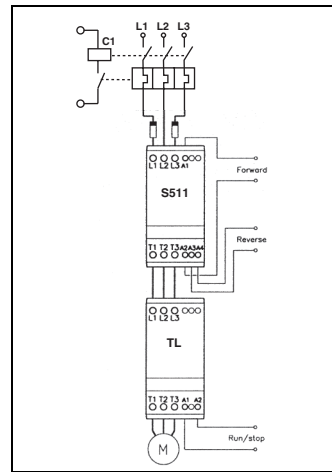

Figure 4. Combining Reversing Electronic Contactor and Torque Limiter \*

### Soft Reversing of Motors up to 5 hp/4 kW

A soft reversing of motor can easily be achieved by connecting a reversing relay to the torque limiter.

The reversing relay type S511 will determine the direction of rotation forward or reverse and the starting torque limiter will perform soft-starting of the motor.

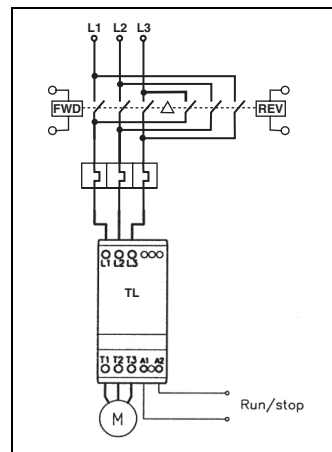

Figure 5. Combining Reversing Mechanical Contactor and Soft Starter

### Reversing of Motors Up to 15 hp/11 kW

A soft-reversing of motors can easily be achieved when the motor load exceeds 5 hp/4 kW by connecting a mechanical reversing contactor to the soft starter.

The reversing contactor will determine the direction of rotation forward or reverse and the starting torque limiter will perform soft-starting of the motor.

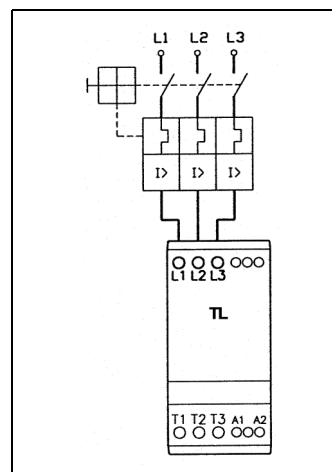

Figure 6. Overload Protection with Manual Motor Starter \*

### Overload Protection with Manual Motor Starter

Overload protection of the motor is easily achieved by installing a manual motor starter on the supply side of the starting torque limiter.

The manual motor starter provides means for padlocking and the necessary clearance for use as a circuit isolator according to EN60204-1.

Select the manual circuit breaker from the selection table or equivalent according to the rated current of the motor.

Adjust the current limiter on the manual motor starter according to the rated nominal current of the motor.

\* Use UL specified backup fuse.

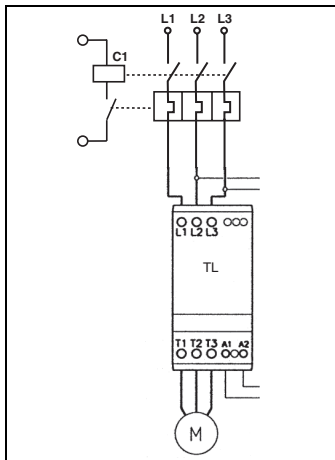

**Figure 7.** Overload Protection with Mechanical Starter

**Overload Protection with Mechanical Starter**

Overload protection of the motor is easily achieved by installing a mechanical starter on the supply side of the starting torque limiter.

The overload provides the necessary motor protection for overload condition.

A short circuit protective device is required to meet UL requirements.

**Specifications**

**Table 1.** Thermal Specifications

| Description   | Specification                   |
|---|---------------------------------|
| Power dissipation for continuous operation PD max.                  | 1 W/A                           |
| Power dissipation for intermittent operation PD                     | 1 W/A x duty cycle              |
| Cooling Method  | Natural convection              |
| Mounting  | Vertical ±30°                   |
| Operating temperature range, EN60947-4-2 (no derating)              | -5° to 40°C *<br>[23° to 104°F] |
| Storage temperature, EN60947-4-2                                    | -20° to 80°C<br>[-40° to 176°F] |
| Max. operating temperature with current derating according to table | 60°C<br>[140°F]                 |

\* UL Tested.

**Table 2.** Insulation Specifications

| Description                     | Specification |
|---------------------------------|---------------|
| Rated insulation voltage        | Ui 660 Volt   |
| Rated impulse withstand voltage | Uimp 4 kVolt  |
| Installation category           | III           |

**Current Derating**

**Current Derating in High Temperature Applications**

Operation in ambient temperatures exceeding 40°C is possible if the power dissipation is limited either by reducing the steady-state current or by reducing the duty cycle of the starting torque limiter as shown in **Table 3**.

No derating under 60°C on the 15A type.

**Table 3.** Temperature Specifications

| Ambient Temperature               | TLXXN25  |
|-----------------------------------|--|
| 50°C [122°F]                      | 23.0A continuous                                 |
| Limited Duty Cycle Rating by 50°C | 25A on-time max. 15 min.<br>Duty cycle max. 0.8  |
| 60°C [140°F]                      | 15A continuous                                   |
| Limited Duty Cycle Rating by 60°C | 25A on-time max. 15 min.<br>Duty cycle max. 0.65 |

**Table 4.** Current Derating by Trip Class

| Overload Trip Class | 15A Type | 25A Type |
|---------------------|----------|----------|
| 10A                 | 15A      | 25A      |
| 10                  | 15A      | 25A      |
| 20                  | 12A      | 20A      |
| 30                  | 10A      | 15A      |

**EMC**

This component meets the requirements of the product standard EN60947-4-2 and is CE marked according to this standard.

|   |
|---|
| <b>Approvals</b><br>CAN/CSA-C22.2 / UL Std. No. 508                     |
| <b>Environment</b><br>Degree of Protection / Pollution Degree: IP20 / 3 |

**Table 5.** Output Specifications

| Description                | TLXXN15          | TLXXN25          |
|----------------------------|------------------|------------------|
| Operational Current (max.) | 15A AC-53a, AC-3 | 25A AC-53a, AC-3 |
| Leakage Current (max.)     | 5 mA AC          | 5 mA AC          |
| Operational Current (min.) | 50 mA            | 50 mA            |

**Table 6.** Time and Torque Settings

| Description    | Specification                             |
|----------------|---|
| Ramp-Up Time   | Adjustable from 0.5 - 5 sec.              |
| Initial Torque | Adjustable from 0 - 85% of nominal torque |

**Product Selection**

**Table 7.** Product Description and Item Selection

| Line Voltage (V AC) | Part Number | Motor Size 3-Phase | Motor Size 1-Phase |
|---------------------|-------------|--------------------|--------------------|
| <b>15A</b>          |             |                    |                    |
| 208                 | TL480N15    | 5.5 hp/0.1-4.0 kW  | —                  |
| 220 – 240           | TL480N15    | 5.5 hp/0.1-4.0 kW  | 3.0 hp/0.1-2.2 kW  |
| 380 – 415           | TL480N15    | 10 hp/0.1-7.5 kW   | —                  |
| 440 – 480           | TL480N15    | 10 hp/0.1-7.5 kW   | —                  |
| 440 – 480           | TL600N15    | —                  | 5.0 hp/0.1-4.0 kW  |
| 550 – 600           | TL600N15    | 15 hp/0.1-10 kW    | —                  |
| <b>25A</b>          |             |                    |                    |
| 208                 | TL480N25    | 7.5 hp/0.1-5.5 kW  | —                  |
| 220 – 240           | TL480N25    | 7.5 hp/0.1-5.5 kW  | 5.0 hp/0.1-4.0 kW  |
| 380 – 480           | TL480N25    | 15 hp/0.1-11 kW    | —                  |
| 380 – 480           | TL600N25    | —                  | 10 hp/0.1-7.5 kW   |
| 550 – 600           | TL600N25    | 25 hp/0.1-18.5 kW  | —                  |

**Short Circuit Protection**

Two types of short circuit protection can be used:

- short circuit protection by circuit breaker
- short circuit protection by fuses

Short circuit protection is divided into two levels — Type 1 and Type 2.

- Type 1 — protects the installation
- Type 2 — protects the installation and the semiconductors inside the motor controller

### Short Circuit Protection by Circuit Breaker

A 3-phase motor with a correctly installed and adjusted over-load relay will not short-circuit totally to earth or between the 3 phases. Part of the winding will normally limit the short circuit current to a value that will cause instantaneous magnetic tripping of the circuit breaker without damage to the torque limiter. The magnetic trip response current is approximately 11 times the maximum adjustable current.

### Short Circuit Protection by Fuses

Type 1

TLXXXN15 — protection max.  $50A_{gI/gL/gG}$

TLXXXN25 — protection max.  $80A_{gI/gL/gG}$  63A T

Type 2

TLXXXN15 — protection max.  $I^2t$  of the fuse 1800A<sup>2</sup>S

TLXXXN25 — protection max.  $I^2t$  of the fuse 6300A<sup>2</sup>S

**NOTE: TLXXXN15** — When protected by a non-time delay K5 or H class fuse rated 266% of motor FLA, this device is rated for use on a circuit capable of delivering not more than 5000 rms symmetrical amperes, 600V maximum.

**TLXXXN25** — When protected by H class fuses, this device is rated for use on a circuit capable of delivering not more than 5000 rms symmetrical amperes, 600V maximum.

### Utilization Categories (IEC 947-4-2)

Table 8. Utilization Categories

| Item   | Specification   |
|--------|---|
| AC-52a | Control of slip-ring motor stators  |
| AC-53a | Control of squirrel cage motor  |
| AC-58a | Control of hermetic refrigerant compressors with automatic resetting of overload releases |

### Rating Index

Table 9. Rating Index

| TLXXXN15                       | TLXXXN25                       |
|--------------------------------|--------------------------------|
| 15A: AC-52a: 4-13 : 100 – 3000 | 25A: AC-52a: 4-13 : 100 – 3000 |
| 15A: AC-53a: 8-3 : 100 – 3000  | 25A: AC-53a: 8-3 : 100 – 3000  |
| 15A: AC-58a: 6-6 : 100 – 3000  | 25A: AC-58a: 6-6 : 100 – 3000  |





### How to Adjust Time and Torque, Figure 8

Control of the motor torque is achieved by acting on the motor voltage. The motor speed depends on the torque produced by the motor and the load on the motor shaft. A motor with little or no load will reach full speed before the voltage has reached its maximum value.

**NOTE:** The starting torque limiter will read time and torque settings in the OFF state. Repeated starts may trip the motor protection relay. Use screwdriver 2 mm x 0.5 mm.

### Ramp-Up Time and Initial Torque

Table 10. Ramp-Up Time and Initial Torque (Standard Load)

| Position  | Setting/Adjustment   |
|---|--|
|    | Set the <b>Ramp-Up</b> potentiometer to maximum.   |
|   | Decrease the <b>Ramp-Up</b> time until desired start is achieved.  |
|  | Set the <b>Initial Torque</b> switch to minimum.   |
|  | Switch the contactor on for a short time. If the load does not rotate immediately, increment the <b>Initial Torque</b> and try again. Repeat until the load starts to rotate immediately on startup. |

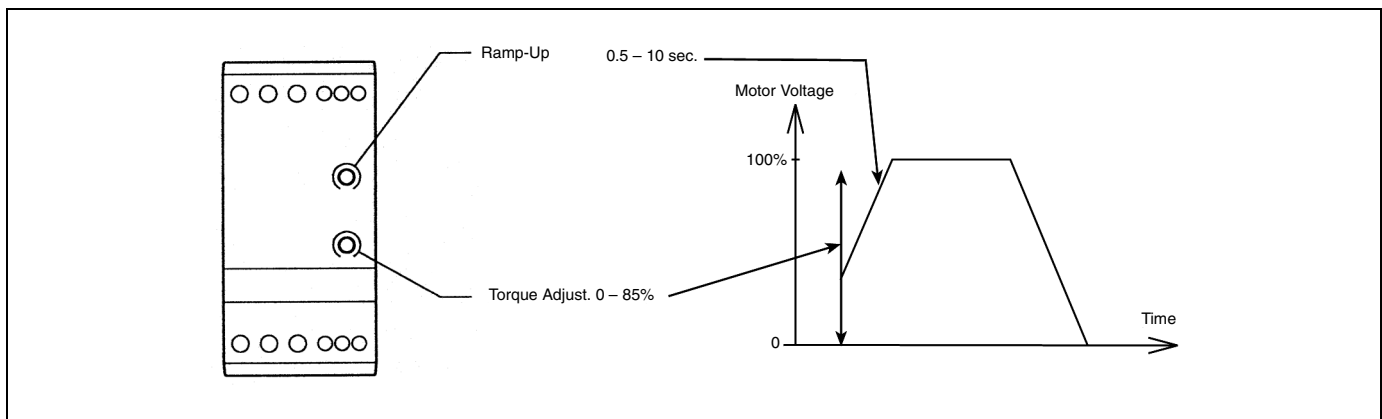

Figure 8. Time and Torque Adjustment