

## Installation Instructions for PSG960R24RM REDUNDANCY MODULE

**READ INSTRUCTIONS BEFORE INSTALLING OR OPERATING THIS DEVICE. KEEP FOR FUTURE REFERENCE.**

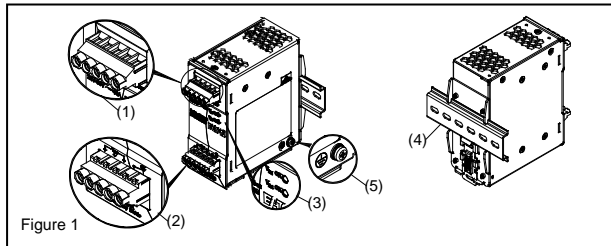

Figure 1

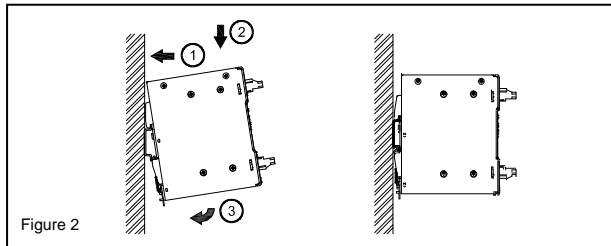

Figure 2

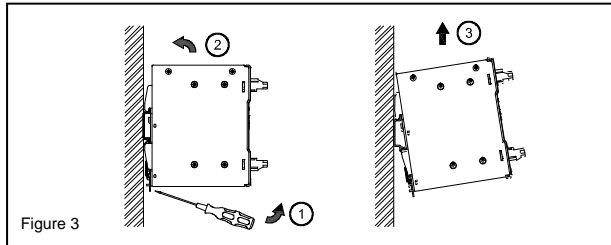

Figure 3

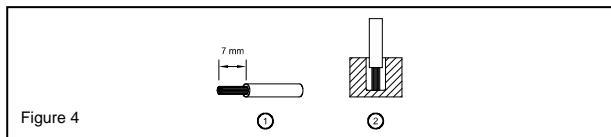

Figure 4

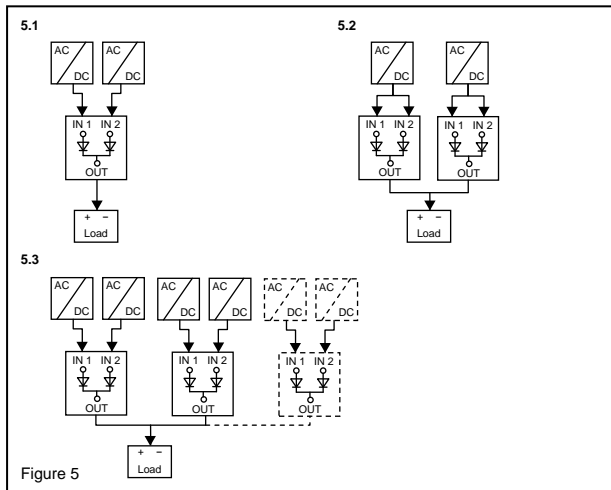

Figure 5

### 1. Safety instructions

- Switch main power off before connecting or disconnecting the device. Danger of explosion!
- To guarantee sufficient convection cooling, please keep a distance of 50 mm above and below the device as well as a lateral distance of 20 mm to other units.
- Please note, that the enclosure of the device can become very hot depending on the ambient temperature and load of the power supply. Risk of burns!
- The main power must be turned off before connecting or disconnecting wires to the terminals!
- Do not introduce any objects into the unit!
- Dangerous voltage present for at least 5 minutes after disconnecting all sources of power.
- The supply of the unit shall comply with any isolated secondary circuit according to UL 508, Clause 32.
- The unit must be installed in an IP54 enclosure or cabinet in the final installation.
- Warning: Explosion Hazard – Substitution of components may impair suitability for Class I, Division 2.
- Warning: Explosion Hazard – Do not disconnect equipment unless the power has been switched off or the area is known to be non-hazardous.

• **CAUTION:** "FOR USE IN A CONTROLLED ENVIRONMENT".

### 2. Device description (Fig. 1)

- (1) Input terminal block connector
- (2) Output terminal block connector
- (3) LED indicator of  $V_{in1}$  &  $V_{in2}$
- (4) Universal mounting rail system
- (5) Earth connection

### 3. Mounting (Fig. 2)

The unit can be mounting on 35 mm DIN rails in accordance with EN 60715. The device should be installed with input block on the top.

Each device is delivered ready to install.

Snap on the DIN rail as shown in Fig. 2:

1. Tilt the unit slightly upwards and put it onto the DIN rail.
2. Push downwards until stopped.
3. Press against the bottom front side for locking.
4. Shake the unit slightly to ensure that it is secured.

### 4. Dismounting (Fig. 3)

To uninstall, pull or slide down the latch as shown in Fig. 3. Then, slide the unit in the opposite direction, release the latch and pull out the unit from the rail.

### 5. Connection

The terminal block connectors allow easy and fast wiring.

You can use flexible (stranded wire) or solid cables with cross section 3.3-5.3 mm<sup>2</sup> (AWG 12-10) and torque of 7.3 Kgf-cm max (6.3 lb in). To secure reliable and shock proof connections, the stripping length should be 7 mm (see Fig. 4 (1)). Please ensure that wires are fully inserted into the connecting terminals as shown in Fig. 4 (2).

In accordance to EN 60950 / UL 60950, flexible cables require ferrules.

Use appropriate copper cables that are designed to sustain operating temperature of 60°C / 75°C or more to fulfill UL requirements.

### 6. Typical application notes (Fig. 5)

1. 1+1 Redundancy: Using 1 more PSU as the redundant unit
2. 1+N Redundancy: Using more PSUs as the redundant units to increase the reliability
3. Single Use: Connecting only one PSU to one PSG960R24RM to reduce the stress of the diodes and hence increase the reliability

Risk of electrical shock, fire, personal injury or death.

- (1) Turn power off before working on the device.
- (2) Make sure of the wiring is correct by following all local and national codes.
- (3) Do not modify or repair the unit.
- (4) Use caution to prevent any foreign objects from entering into the housing.
- (5) Do not use in wet locations.
- (6) Do not use the unit in area where moisture or condensation can be expected.

**FOR TECHNICAL ASSISTANCE CALL 1 - 877 - ETN - CARE**

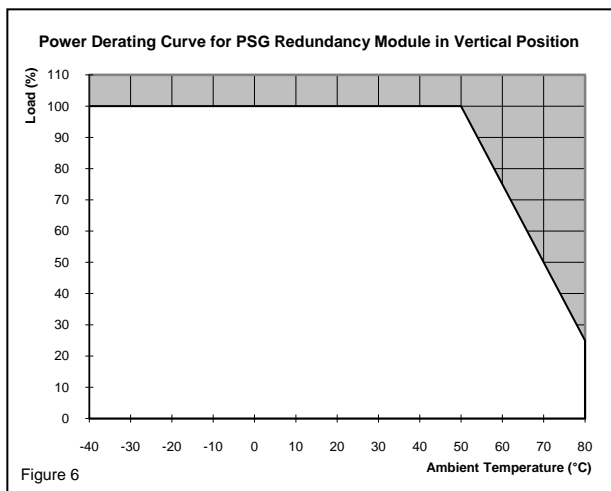



Figure 6

### TECHNICAL DATA FOR PSG960R24RM

<b>Input (DC)</b>	
Nominal input	24 VDC and 48 VDC
Voltage range	22-60 VDC (For UL 508)
Input current	(1+1 Redundancy) = Nom. 2x25 Amps, See 5.1 (N+1 Redundancy) = Nom. 2x20 Amps, See 5.3 (Single use) = Nom. 1x40 Amps, See 5.2
Input voltage alarm	24 V system: both $V_{in1}$ & $V_{in2} > 18V \pm 5\%$ or $< 30 V$ max. 48 V system: both $V_{in1}$ & $V_{in2} > 36V \pm 5\%$ or $< 60 V$ max.
<b>Output (DC)</b>	
Output voltage	Input - 0.65 V
Nominal current	40A Max.
Derating	$> 50^{\circ}\text{C}$ (2.5% / $^{\circ}\text{C}$ )
Component Derating	$V_{in} = 22\text{-}60$ VDC, Max. Load - $T_{\text{ambient}} = 50^{\circ}\text{C}$ - $T_j < 85\%$ of $T_{j\text{max}}$
Voltage drop	0.65 V
Efficiency	$> 97.0\%$ typ.
Short circuit	$< 50$ A, No damage
<b>General Data</b>	
Type of housing	Aluminum
Signals	Green LED $V_{in1}$ & $V_{in2}$
MTBF	$> 800,000$ hrs. Tested @ Max. Load with $25^{\circ}\text{C}$ ambient and 24 VDC & 48 VDC input
Relay contact (max.)	30 VDC / 1 A
Dimensions (L x W x H)	121 mm x 50 mm x 122 mm
Weight	0.52 kg
Connection method	Screw connection
Stripping length	7 mm
Operating temperature (surrounding air temperature)	$-40^{\circ}\text{C}$ to $+80^{\circ}\text{C}$ (Refer to Fig. 6)
Storage temperature	$-40^{\circ}\text{C}$ to $+85^{\circ}\text{C}$
Humidity at $+25^{\circ}\text{C}$ , no condensation	$< 95\%$ RH
Vibration (non-operating)	10 to 500 Hz @ 30 $\text{m/s}^2$ (3 G peak); displacement of 0.35 mm; 60 min. per axis for all X, Y, Z directions in acc. with IEC 60068-2-6
Shock (in all directions)	30 G (300 $\text{m/s}^2$ ) in all directions according to IEC 60068-2-27
Altitude (operating)	2,500 Meters
Pollution degree	2
<b>Certification and Standards</b>	
Electrical equipments of machines	IEC 60204-1
Electronic equipment for use in electrical power installations	EN 50178 / IEC 62103
Safety entry low voltage	PELV (EN 60204), SELV (EN 60950)
Industrial control equipment	cULus recognized to UL 508 and CSA C22.2 No.107.1-01
Hazardous location	cCSAus to CSA C22.2 No.213-M1987, ANSI / ISA 12.12.01:2007 [Class I, Division 2, Group A,B,C,D T4, $T_a = -40^{\circ}\text{C}$ to $+80^{\circ}\text{C}$ ( $> +50^{\circ}\text{C}$ derating)]
Protection against electric shock	DIN 57100-410
CE	In conformance with EMC directive 2004/108/EC and low voltage directive 2006/95/EC
ITE	EN 55022, EN 61000-3-2, EN 61000-3-3, EN 55024
Industrial	EN 55011
Limitation of mains harmonic currents	EN 61000-3-2
	
RoHS Compliant	Yes
<b>Safety and Protection</b>	
Isolation voltage: Input & Output / PE	1.5 kVAC
Protection degree	IP20
Safety class	Class III with PE connection