

## Installation Instructions for PSG120F POWER SUPPLY

**READ INSTRUCTIONS BEFORE INSTALLING OR OPERATING THIS DEVICE. KEEP FOR FUTURE REFERENCE.**

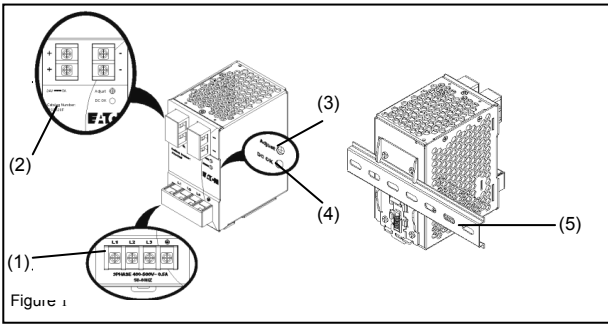

Figure 1

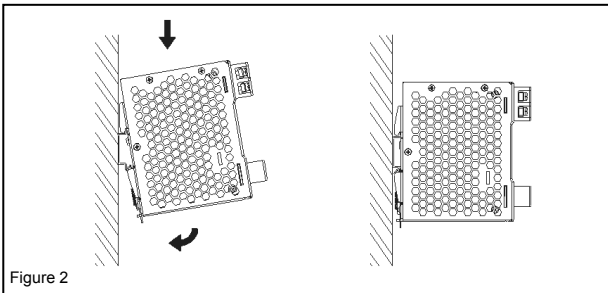

Figure 2

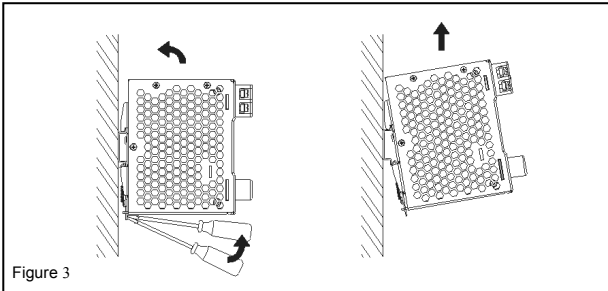

Figure 3

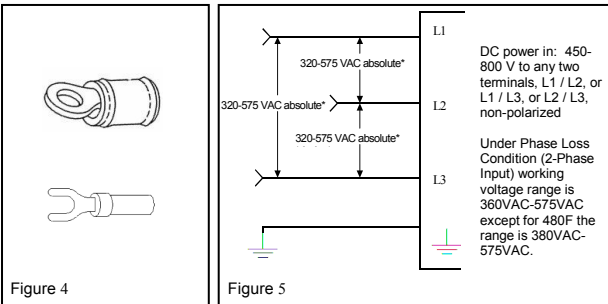

Figure 4

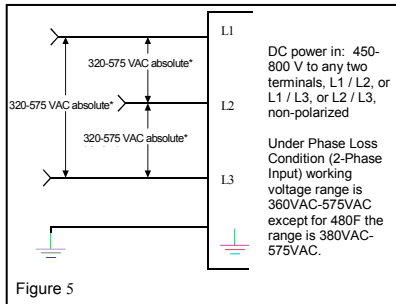

Figure 5

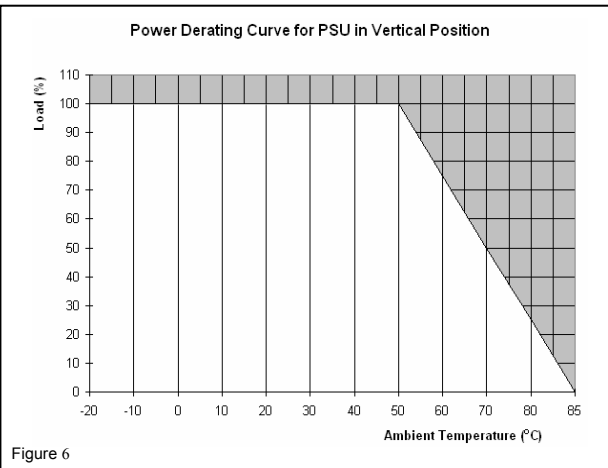

Figure 6

### 1. Safety instructions

- Switch main power off and wait 5 minutes before making any connection or disconnection on the device. Danger of explosion!
- Dangerous voltage present for at least 5 minutes after disconnecting all sources of power.
- For sufficient convection cooling keep a distance of 50 mm above and below the device as well as a lateral distance of 20 mm to other units.
- The enclosure of the device can become very hot depending on the ambient temperature and load of the power supply. Risk of burns!
- Do not introduce any objects into the unit!

### 2. Device description (Fig. 1)

- (1) Input terminal block connector
- (2) Output terminal block connector
- (3) DC voltage adjustment potentiometer
- (4) DC OK control LED (green)
- (5) Universal mounting rail system

### 3. Mounting (Fig. 2)

The power supply unit can be mounted on 35 mm DIN rails in accordance with EN 60715. The device should be installed horizontally with input terminal blocks on the bottom. Each device is delivered ready to install.

Snap on the DIN rail as shown in Fig. 2:

1. Tilt the unit slightly upwards and put it onto the DIN rail.
2. Push downwards until stopped.
3. Press against the bottom front side for locking.
4. Shake the unit slightly to ensure that it is secured.

### 4. Removal (Fig. 3)

To uninstall, pull or slide down the latch as shown in Fig. 3. Then, slide the PSU in the opposite direction, release the latch and pull out the PSU from the rail.

### 5. Connection

The terminal block connectors allow easy and fast wiring. A plastic cover provides the necessary isolation of the electric connection.

Use flexible (stranded wire) or solid cables 0.82-8.4 mm<sup>2</sup> (AWG 18-8) and torque of 1.18-1.57 Nm (10.41-13.89 lb in). The insulation stripping length should be 7 mm

In accordance to EN 60950 / UL 60950, flexible cables require ferrules.

Use copper wire that is designed to sustain operating temperature of 75°C or more to fulfill UL requirements.

For stranded wires it is recommended to use suitable lug to crimp wires (See Fig. 4).

#### 5.1. Input connection (Fig. 1 and Fig. 5)

Use L1, L2, L3 and PE connections of input terminal connector (see Fig. 5) to establish the 3 x 400-500 VAC connection.

In the event of a phase failure, unrestricted operation is possible with nominal capacity.

The device has an internal fuse. 3 x power circuit-breakers 6 A, 10 A or 16 A are recommended as backup fuses.



The internal fuse must not be replaced by the user.  
In case of internal defect, Please call 1- 877- ETN - CARE

#### 5.2. Output connection (Fig. 1 (2))

Use the "+" and "-" screw connections to establish the 24 VDC connection. The output provides 24 VDC. The output voltage can be adjusted from 22 to 28 VDC on the potentiometer. The green LED DC OK displays correct function of the output (Fig. 1 (4)).

The device has a short circuit and overload protection and an over voltage protection limited to 35 VDC.

#### 5.3. Output characteristic curve







The device functions normal under operating line and load conditions. In the event of a short circuit or over load the output voltage and current collapses ( $I_{O/L}$  or  $I_{S/C}$  is  $> I_{surge}$  (150%)). The secondary voltage is reduced and bounces until short circuit or over load on the secondary side has been removed.

#### 5.4. Thermal behavior (Fig. 6)

In the case of ambient temperatures above +50°C, the output capacity has to be reduced by 2.5% per increase in temperature. If the output capacity is not reduced when  $T_{Amb} > 50$  °C device will run into thermal protection by switching off i.e. device will go in bouncing mode and will recover when ambient temperature is lowered or load is reduced as far as necessary to keep device in working condition.

**FOR TECHNICAL ASSISTANCE CALL 1 - 877- ETN – CARE**

**TECHNICAL DATA FOR PSG120F**

<b>Input (AC)</b>	
Nominal input voltage	3 x 400-500 VAC
Voltage range	320-575 VAC (DC input range 450-800 VDC)
Frequency	47-63 Hz (0 Hz @ DC input)
Nominal current	0.5 A @ 400 VAC approx.
Inrush current limitation. I <sup>2</sup> t (+25 °C) typ.	< 30 A @ 400 VAC
Mains buffering at nominal load (typ.)	> 35 ms @ 3 x 400 VAC, > 70 ms @ 3 x 500 VAC
Turn-on time	< 1 sec.
Internal fuse	3.15 AH / 500 V
Recommended backup fuse	3 x circuit breakers 6 A, 10 A or 16 A
Power circuit-breaker characteristic	B
Leakage current	< 3.5 mA
<b>Output (DC)</b>	
Nominal output voltage UN / tolerance	24 VDC ± 2 %
Adjustment range of the voltage	22-28 VDC
Nominal current	5 A
Derating above +50 °C	2.5 % / K.
Startup with capacitive loads	Max. 10,000 µF
Max. power dissipation idling / nominal load approx.	18 W
Efficiency (at 400V AC and nominal values)	> 86% @ 3 x 400 VAC, > 85% @ 3 x 500 VAC
Residual ripple/ peak switching (20 MHz) (at nominal values)	< 50 mV / < 240 mVpp
Parallel operation	With oring diode
<b>General Data</b>	
Type of housing	Aluminium (Al5052)
Signals	Green LED DC OK
MTBF	> 500,000 hrs.
Dimensions (L x W x H)	121 mm x 70 mm x 118.5 mm
Weight	0.72 kg
Connection method	Screw connection
Stripping length	7 mm or use suitable lug to crimp
Operating temperature	-20 °C to +75 °C (> 50°C derating)
Storage temperature	-25 °C to +85 °C
Humidity at +25 °C, no condensation	< 95 % RH
Vibration (operating)	10 to 150 Hz, 0.35 mm acc. 50 m / s <sup>2</sup> , single amplitude (5 G max.) for 90 min. in each X, Y & Z directions, in acc. with IEC 68-2-6
Pollution degree	2
Climatic class	3K3 according to EN 60721
<b>Certification and Standards</b>	
Electrical equipments of machines	IEC60204-1 (over voltage category III)
Electronic equipment for use in electrical power installations	EN50178 / IEC62103
Safety entry low voltage	PELV (EN60204), SELV (EN60950)
Electrical safety (of information technology equipment)	EN60950-1 (GS-mark), UL/C-UL recognized to UL60950-1, CSA C22.2 No. 60950-1, CB scheme to IEC60950-1, cCSAus to UL60950-1 and CSA C22.2 No.60950-1 (file no.181564)
Industrial control equipment	UL listed to UL508 CSA to CSA107.1-01 (File no.181564)
Protection against electric shock	DIN 57100-410
CE	In conformance with EMC directive 2004/108/EC and low voltage directive 2006/95/EC.
ITE	EN55022,EN61000-3-2,EN61000-3-3, EN55024
Industrial	EN55011
Limitation of mains harmonic currents	EN61000-3-2 CLASS A Limit
	     
<b>RoHS Compliant</b>	<b>Yes</b>
<b>Safety and Protection</b>	
Transient surge voltage protection	VARISTOR
Current limitation at short-circuits approx.	I <sub>surge</sub> = 150 % of P <sub>o,max</sub> typically
Surge voltage protection against internal surge voltages	Yes
Isolation voltage:	
Input / output (type test/routine test)	4 kVAC / 3 kVAC
Input / PE (type test/routine test)	1.5 kVAC / 1.5 kVAC
Output / PE (type test/routine test)	1.5 kVAC / 500 VAC
Protection degree	IPX0
Safety class	Class I with PE connection
Shock (in all directions)	30 G (300 m/s <sup>2</sup> ) in all directions according to IEC 68-2-27