

Control Relay
easy500, easy700



Powering Business Worldwide

All brand and product names are trademarks or registered trademarks of the owner concerned.

Emergency On Call Service

Please call your local representative:

<http://www.eaton.com/moeller/aftersales>

or

Hotline of the After Sales Service:

+49 (0) 180 5 223822 (de, en)

AfterSalesEGBonn@eaton.com

Original Operating Instructions

The German-language edition of this document is the original operating manual.

Translation of the original operating manual

All editions of this document other than those in German language are translations of the original German manual.

1st published 2004, edition date 05/04,
2nd edition 05/10,
See revision protocol in the "About this manual"
chapter

© 2004 by Eaton Industries GmbH, 53105 Bonn

Production: DHW

Translation: globaldocs GmbH

All rights reserved, including those of the translation.

No part of this manual may be reproduced in any form (printed, photocopy, microfilm or any other process) or processed, duplicated or distributed by means of electronic systems without written permission of Eaton Industries GmbH, Bonn.

Subject to alteration without notice.



Danger! **Dangerous electrical voltage!**

Before commencing the installation

- Disconnect the power supply of the device.
- Ensure that devices cannot be accidentally restarted.
- Verify isolation from the supply.
- Earth and short circuit.
- Cover or enclose neighbouring units that are live.
- Follow the engineering instructions (AWA) of the device concerned.
- Only suitably qualified personnel in accordance with EN 50110-1/-2 (VDE 0105 Part 100) may work on this device/system.
- Before installation and before touching the device ensure that you are free of electrostatic charge.
- The functional earth (FE) must be connected to the protective earth (PE) or to the potential equalisation. The system installer is responsible for implementing this connection.
- Connecting cables and signal lines should be installed so that inductive or capacitive interference does not impair the automation functions.
- Install automation devices and related operating elements in such a way that they are well protected against unintentional operation.
- Suitable safety hardware and software measures should be implemented for the I/O interface so that a line or wire breakage on the signal side does not result in undefined states in the automation devices.
- Ensure a reliable electrical isolation of the low voltage for the 24 volt supply. Only use power supply units complying with IEC 60364-4-41 (VDE 0100 Part 410) or HD 384.4.41 S2.
- Deviations of the mains voltage from the rated value must not exceed the tolerance limits given in the specifications, otherwise this may cause malfunction and dangerous operation.
- Emergency stop devices complying with IEC/EN 60204-1 must be effective in all operating modes of the automation devices. Unlatching the emergency-stop devices must not cause restart.
- Devices that are designed for mounting in housings or control cabinets must only be operated and controlled after they have been installed with the housing closed. Desktop or portable units must only be operated and controlled in enclosed housings.
- Measures should be taken to ensure the proper restart of programs interrupted after a voltage dip or failure. This should not cause dangerous operating states even for a short time. If necessary, emergency-stop devices should be implemented.
- Wherever faults in the automation system may cause damage to persons or property, external measures must be implemented to ensure a safe operating state in the event of a fault or malfunction (for example, by means of separate limit switches, mechanical interlocks etc.).

Contents

| | | |
|----------|---|-----------|
| 0 | About This Manual..... | 7 |
| 0.1 | List of revisions | 7 |
| 0.2 | Device designation..... | 7 |
| 0.3 | Writing conventions | 8 |
| 1 | easy..... | 9 |
| 1.1 | Target group..... | 9 |
| 1.2 | Proper use..... | 9 |
| 1.2.1 | Improper use..... | 9 |
| 1.3 | Overview..... | 10 |
| 1.4 | Versions | 12 |
| 1.4.1 | Key to part numbers..... | 14 |
| 1.5 | easyoperating principles | 15 |
| 1.5.1 | Key Pad | 15 |
| 1.5.2 | Selecting menus and entering values | 15 |
| 1.5.3 | Choosing the main and system menu | 16 |
| 1.5.4 | Status indicator easy | 17 |
| 1.5.5 | Status display for local expansion | 17 |
| 1.5.6 | Advanced Status display | 17 |
| 1.5.7 | easyLED display | 18 |
| 1.5.8 | Menu structure | 18 |
| 1.5.9 | Selecting or toggling between menu items | 22 |
| 1.5.10 | Cursor display..... | 22 |
| 1.5.11 | Set value | 23 |
| 2 | Installation..... | 25 |
| 2.1 | Mounting..... | 26 |
| 2.1.1 | Mounting on top-hat rail..... | 26 |
| 2.1.2 | Screw mounting..... | 27 |
| 2.2 | Connecting the expansion device | 28 |
| 2.3 | Terminations | 29 |
| 2.3.1 | Tools..... | 29 |
| 2.3.2 | Cable cross-sections | 29 |
| 2.4 | Connecting the power supply | 29 |
| 2.4.1 | Cable protection | 29 |
| 2.4.2 | Supplying AC basic units..... | 29 |
| 2.4.3 | Supplying AC expansion units..... | 30 |
| 2.4.4 | Supplying DC basic units..... | 31 |
| 2.4.5 | Supplying DC expansion devices | 31 |
| 2.5 | Connecting inputs | 32 |
| 2.5.1 | Connect digital AC inputs..... | 32 |
| 2.5.2 | Connecting easy DC digital inputs | 36 |
| 2.5.3 | Connecting analog inputs..... | 37 |
| 2.5.4 | Connecting high-speed counters and frequency generators | 41 |

| | | |
|----------|--|-----------|
| 2.6 | Connecting outputs..... | 42 |
| 2.6.1 | Connecting relay outputs..... | 42 |
| 2.6.2 | Connecting transistor outputs..... | 44 |
| 2.6.3 | Behavior in the event of a short-circuit/overload..... | 46 |
| 2.7 | Expanding inputs/outputs . | 46 |
| 2.7.1 | Local expansion module | 47 |
| 2.7.2 | Remote expansion | 48 |
| 2.8 | Connecting bus systems | 49 |
| 3 | Placing into operation | 51 |
| 3.1 | Switch-on..... | 51 |
| 3.2 | Setting the menu language..... | 51 |
| 3.3 | easyoperating modes | 52 |
| 3.4 | Creating your first circuit diagram..... | 52 |
| 3.4.1 | Circuit diagram display | 54 |
| 3.4.2 | From the first contact to the output coil | 55 |
| 3.4.3 | Wiring | 55 |
| 3.4.4 | Testing the circuit diagram..... | 57 |
| 3.4.5 | Deleting the circuit diagram..... | 58 |
| 3.4.6 | Fast circuit diagram entry..... | 58 |
| 4 | Wiring easy with | 59 |
| 4.1 | easy-operation | 59 |
| 4.1.1 | Buttons for editing circuit diagrams and function relays..... | 59 |
| 4.1.2 | Operation..... | 59 |
| 4.1.3 | Relays, function relays..... | 63 |
| 4.1.4 | Saving and loading circuit diagrams..... | 65 |
| 4.2 | Working with contacts and relays..... | 66 |
| 4.2.1 | Input and output contacts..... | 66 |
| 4.2.2 | Creating and modifying connections..... | 68 |
| 4.2.3 | Inserting and deleting a rung | 69 |
| 4.2.4 | Switching with the Cursor Buttons..... | 70 |
| 4.2.5 | Checking the circuit diagram..... | 71 |
| 4.2.6 | Coil Functions | 72 |
| 4.3 | Function Relays..... | 77 |
| 4.3.1 | Example: with function relay timer and counter relay..... | 78 |
| 4.4 | Analog value comparator/threshold value switch | 82 |
| 4.4.1 | Circuit diagram display with analog value comparator | 84 |
| 4.4.2 | Compatibility with easy400 witheasy500 and easy600 with easy700 | 84 |
| 4.4.3 | Parameter display in RUN mode..... | 85 |
| 4.4.4 | Resolution of the analog inputs | 86 |
| 4.4.5 | Function of the analog value comparator function relay | 86 |
| 4.5 | Counter | 94 |
| 4.5.1 | Function of the counter function relay | 97 |
| 4.6 | High-speed counters, easy-DA, easy-DC..... | 100 |
| 4.6.1 | Frequency Counter | 100 |

| | | |
|--------|---|-----|
| 4.6.2 | High-speed counters | 103 |
| 4.7 | Text Display..... | 109 |
| 4.7.1 | Wiring a text display..... | 109 |
| 4.7.2 | Retention..... | 109 |
| 4.7.3 | Scaling..... | 110 |
| 4.7.4 | Function | 110 |
| 4.7.5 | Text Entry..... | 111 |
| 4.7.6 | Font..... | 111 |
| 4.7.7 | Entering a setpoint in a display | 111 |
| 4.8 | Weekly timer..... | 113 |
| 4.8.1 | Parameter display and parameter set for weekly timer: | 114 |
| 4.8.2 | Changing time switch channel..... | 115 |
| 4.8.3 | Function of the weekly timer (example parameter setting) | 115 |
| 4.9 | Operating Hours Counter | 118 |
| 4.9.1 | Value range of the operating hours counter..... | 119 |
| 4.9.2 | Accuracy of the operating hours counter | 119 |
| 4.9.3 | Function of the operating hours counter function relay | 119 |
| 4.10 | Timing Relay..... | 122 |
| 4.10.1 | Parameter display and parameter set for a timing relay:..... | 123 |
| 4.10.2 | Retention..... | 124 |
| 4.10.3 | Timing relay modes..... | 124 |
| 4.10.4 | Time Range | 125 |
| 4.10.5 | Function of the timing relay function relay..... | 127 |
| 4.10.6 | Examples timing relay | 132 |
| 4.11 | Jumps | 135 |
| 4.11.1 | Function | 135 |
| 4.11.2 | Power Flow Display | 136 |
| 4.12 | Year Time Switch | 137 |
| 4.12.1 | Function | 137 |
| 4.12.2 | Behavior in the event of a power failure | 138 |
| 4.12.3 | Wiring of a year time switch | 138 |
| 4.12.4 | Parameter display and parameter set for year time switch | 138 |
| 4.12.5 | Changing time switch channel..... | 139 |
| 4.12.6 | Entry rules..... | 140 |
| 4.12.7 | Function of the year time switch | 142 |
| 4.12.8 | Year time switch for sample parameter configurations | 142 |
| 4.13 | Master Reset | 147 |
| 4.13.1 | Operating modes | 148 |
| 4.13.2 | Function of the master reset function relay | 148 |
| 4.14 | Basic circuits | 149 |
| 4.14.1 | Negation (contact)..... | 149 |
| 4.14.2 | Negation (coil) | 149 |
| 4.14.3 | Permanent contact..... | 149 |
| 4.14.4 | Series circuit..... | 150 |
| 4.14.5 | Parallel connection | 150 |
| 4.14.6 | Parallel circuit operating like a series connection of make contacts..... | 151 |

| | | |
|----------|---|------------|
| 4.14.7 | Parallel circuit operating like a series connection of break contacts | 152 |
| 4.14.8 | Two way switch..... | 152 |
| 4.14.9 | Self maintaining | 153 |
| 4.14.10 | Impulse relays..... | 154 |
| 4.14.11 | Cycle pulse on rising edge | 154 |
| 4.14.12 | Cycle pulse on falling edge | 154 |
| 4.15 | Circuit examples | 155 |
| 4.15.1 | Star-delta starting..... | 155 |
| 4.15.2 | 4x shift register | 156 |
| 4.15.3 | Running light..... | 159 |
| 4.15.4 | Stairwell lighting..... | 160 |
| 5 | easysettings..... | 163 |
| 5.1 | Password protection | 163 |
| 5.1.1 | Password setup | 164 |
| 5.1.2 | Selecting the scope of the password | 164 |
| 5.1.3 | Activating Passwords..... | 165 |
| 5.1.4 | easy unlocking..... | 165 |
| 5.1.5 | Changing or deleting the password range | 166 |
| 5.1.6 | Password incorrect or no longer known | 167 |
| 5.2 | Changing the menu language | 167 |
| 5.3 | Alter parameters | 168 |
| 5.3.1 | Adjustable parameters for function relays | 169 |
| 5.4 | Setting date and time..... | 170 |
| 5.4.1 | Set time | 170 |
| 5.4.2 | Setting summer time start and end..... | 171 |
| 5.4.3 | Setting summer time start and end..... | 172 |
| 5.4.4 | Summer time start and end, setting the rule..... | 172 |
| 5.5 | Activating input delay (debounce)..... | 176 |
| 5.5.1 | Activating debounce (input delay)..... | 176 |
| 5.5.2 | Deactivating debounce (input delay)..... | 177 |
| 5.6 | Activating and deactivating the P buttons..... | 177 |
| 5.6.1 | Activating P buttons..... | 177 |
| 5.6.2 | Function of the P buttons | 178 |
| 5.6.3 | Deactivating the P buttons..... | 178 |
| 5.7 | Startup behavior..... | 178 |
| 5.7.1 | Setting the startup behavior..... | 178 |
| 5.7.2 | Behavior when the circuit diagram is deleted..... | 179 |
| 5.7.3 | Behavior during upload/download to card or PC..... | 179 |
| 5.7.4 | Possible Faults..... | 179 |
| 5.7.5 | Card startup behavior..... | 180 |
| 5.8 | Setting the cycle time | 181 |
| 5.9 | Retention (non-volatile data storage) | 181 |
| 5.9.1 | Permissible markers and function relays | 182 |
| 5.9.2 | Setting retentive behavior..... | 182 |
| 5.9.3 | Deleting retentive actual values..... | 183 |

| | | |
|----------|--|------------|
| 5.9.4 | Transferring retentive behavior | 183 |
| 5.9.5 | Changing the operating mode or the circuit diagram | 183 |
| 5.9.6 | Changing the startup behavior in the SYSTEM menu | 184 |
| 5.10 | Displaying device information | 185 |
| 6 | easy Internal..... | 187 |
| 6.1 | easy circuit diagram cycle..... | 187 |
| 6.1.1 | easyoperation and effects on circuit diagram creation | 188 |
| 6.2 | Delay times for inputs and outputs | 189 |
| 6.2.1 | Delay times with easy-DA and easy-DC basic units..... | 189 |
| 6.2.2 | Delay time with easy-AB, easy-AC basic units..... | 190 |
| 6.2.3 | Delay times for the analog inputs of easy-AB, easy-DA and easy-DC | 191 |
| 6.3 | Monitoring of the functionality of the basic unit | 192 |
| 6.4 | Monitoring of short-circuit/overload with EASY..-D.-T..... | 192 |
| 6.5 | easy700 expanding | 193 |
| 6.5.1 | How is an expansion unit recognized?..... | 193 |
| 6.5.2 | Transfer behavior | 194 |
| 6.5.3 | Function monitoring of expansion units | 194 |
| 6.6 | Saving and loading circuit diagrams | 195 |
| 6.6.1 | EASY...-X | 195 |
| 6.6.2 | Interface | 196 |
| 6.7 | Memory card..... | 197 |
| 6.7.1 | Compatibility with EASY-M-8K, EASY-M-16K memory cards | 197 |
| 6.7.2 | Loading or saving circuit diagrams | 198 |
| 6.8 | easySoft..... | 200 |
| 6.8.1 | Program transfer between easySoft and easy500/700..... | 200 |
| 6.8.2 | easySoft help | 201 |
| 6.9 | easy with a remote display and operator unit..... | 202 |
| 6.10 | Device version..... | 202 |
| 7 | What Happens If ...? | 203 |
| 7.1 | Messages from the easysystem | 203 |
| 7.2 | Possible situations when creating circuit diagrams | 204 |
| 7.3 | Event | 205 |
| 8 | Appendix..... | 207 |
| 8.1 | Approval and Certification | 207 |
| 8.1.1 | Approvals and national approvals for easy500/700 devices | 207 |
| 8.1.2 | Shipping approvals for easy500/700 devices..... | 207 |
| 8.1.3 | Approvals and national approvals for expansion devices | 208 |
| 8.1.4 | Shipping approvals for expansion units easy6..... | 208 |
| 8.2 | Dimensions | 208 |
| 8.3 | Technical data | 210 |
| 8.3.1 | Standards | 210 |

| | | |
|----------|--|------------|
| 8.3.2 | General | 210 |
| 8.3.3 | Power supply | 212 |
| 8.3.4 | Digital inputs | 213 |
| 8.3.5 | Rapid counter inputs | 217 |
| 8.3.6 | Analog inputs | 217 |
| 8.3.7 | Relay outputs | 218 |
| 8.3.8 | Transistor outputs | 220 |
| 8.4 | List of the function relays | 222 |
| 8.4.1 | Usable contacts | 222 |
| 8.4.2 | Available function relays | 223 |
| 8.4.3 | Names of relays | 223 |
| 8.4.4 | Names of function relay | 224 |
| 8.4.5 | Name of function block inputs (constants, operands)..... | 224 |
| 8.5 | Compatibility of the function relay parameters | 224 |
| 8.5.1 | Parameter display of analog value comparator | 224 |
| 8.5.2 | Parameter display of counters | 225 |
| 8.5.3 | Parameter display of weekly timer | 225 |
| 8.5.4 | Parameter display of timing relay..... | 225 |
| 8.5.5 | Compatibility of memory cards | 225 |
| 9 | Glossary of terms..... | 227 |

0 About This Manual

This manual describes the installation, commissioning and programming (circuit diagram generation) of the easy500 and easy700 control relay.

Specialist electrical training is needed for commissioning and creating circuit diagrams. When active components such as motors or pressure cylinders are controlled, parts of the system can be damaged and persons put at risk if the MFD device is connected or programmed incorrectly.

0.1 List of revisions

The following are the main changes and amendments which have been made since the edition 08/04 and 01/05 of this manual:

| Publication date | Page | Subject | New | Modification |
|------------------|------|--|-----|--------------|
| 05/10 | 29 | Hazard warning about the correct connection of the L main pole and N neutral conductor | ✓ | |
| | 127 | Timing relay - Signal Diagrams in fig. 64 + 68 | | ✓ |
| | 127 | Timing relay - Retriggering during response delay | | ✓ |
| | 137 | year time switch - additional examples | ✓ | |
| | 194 | Times of the timeout watchdogs, system control | ✓ | |
| | 225 | „Compatibility of memory cards“ | ✓ | |

0.2 Device designation

This manual uses the following abbreviated designations for different device models:

| Designation | Device types |
|-------------|---|
| easy500 | EASY512-AB... EASY512-AC... EASY512-DA... EASY512-DC... |
| easy700 | EASY719-AB... EASY719-AC... EASY719-DA... EASY719-DC... EASY721-DC... |
| easy-AB | EASY512-AB... EASY719-AB... |
| easy-AC | EASY512-AC... EASY618-AC-RE EASY719-AC.. |
| easy-DA | EASY512-DA... EASY719-DA... |

0 About This Manual
 0.3 Writing conventions

| Designation | Device types |
|-----------------------|--|
| easy-DC | EASY512-DC... EASY6..-DC... EASY719-DC... EASY721-DC... |
| easy-E | EASY2.. EASY618-AC-RE EASY618-DC-RE EASY620-DC-TE |
| EASY512-... EASY7...- | Type designation of the control relay, the dots represent placeholders for all characters used |

0.3 Writing conventions

Symbols used in this manual have the following meanings:

▶ indicates actions to be taken.

CAUTION
 Warns about the possibility of material damage.

 **WARNING**
 Warns of the possibility of hazardous situations that may possibly cause injury.

 **WARNING**
 Warns of the possibility of hazardous situations that could result in serious injury or even death.

 **DANGER**
 Warns of hazardous situations that result in serious injury or death.

 Draws your attention to interesting tips and supplementary information.

For greater clarity, the name of the current chapter is shown in the 1. headline and the name of the current section in the 2. headline.

1 easy

1.1 Target group

easy must only be installed and connected up by trained electricians or other persons who are familiar with the installation of electrical equipment.

Specialist electrical training is needed for commissioning and creating circuit diagrams. When active components such as motors or pressure cylinders are controlled, parts of the system can be damaged and persons put at risk if the MFD device is connected or programmed incorrectly.

1.2 Proper use

easy is a programmable switching and controlgear and is used as a replacement for relay and contactor control circuits. easy may only be operated when it has been correctly and properly installed.

- easy is designed to be installed in an enclosure, switch cabinet or service distribution board. Both the power supply and the signal terminals must be laid and covered so as to prevent accidental contact.
- The installation must comply with regulations for electromagnetic compatibility EMC.
- The power up of easy must not cause any hazards arising from activated devices, such as unexpected motor startups or power ups.

1.2.1 Improper use

easy should not be used as a substitute for safety-related controls such as burner or crane controls, emergency-stop or two-hand safety controls.

1.3 Overview

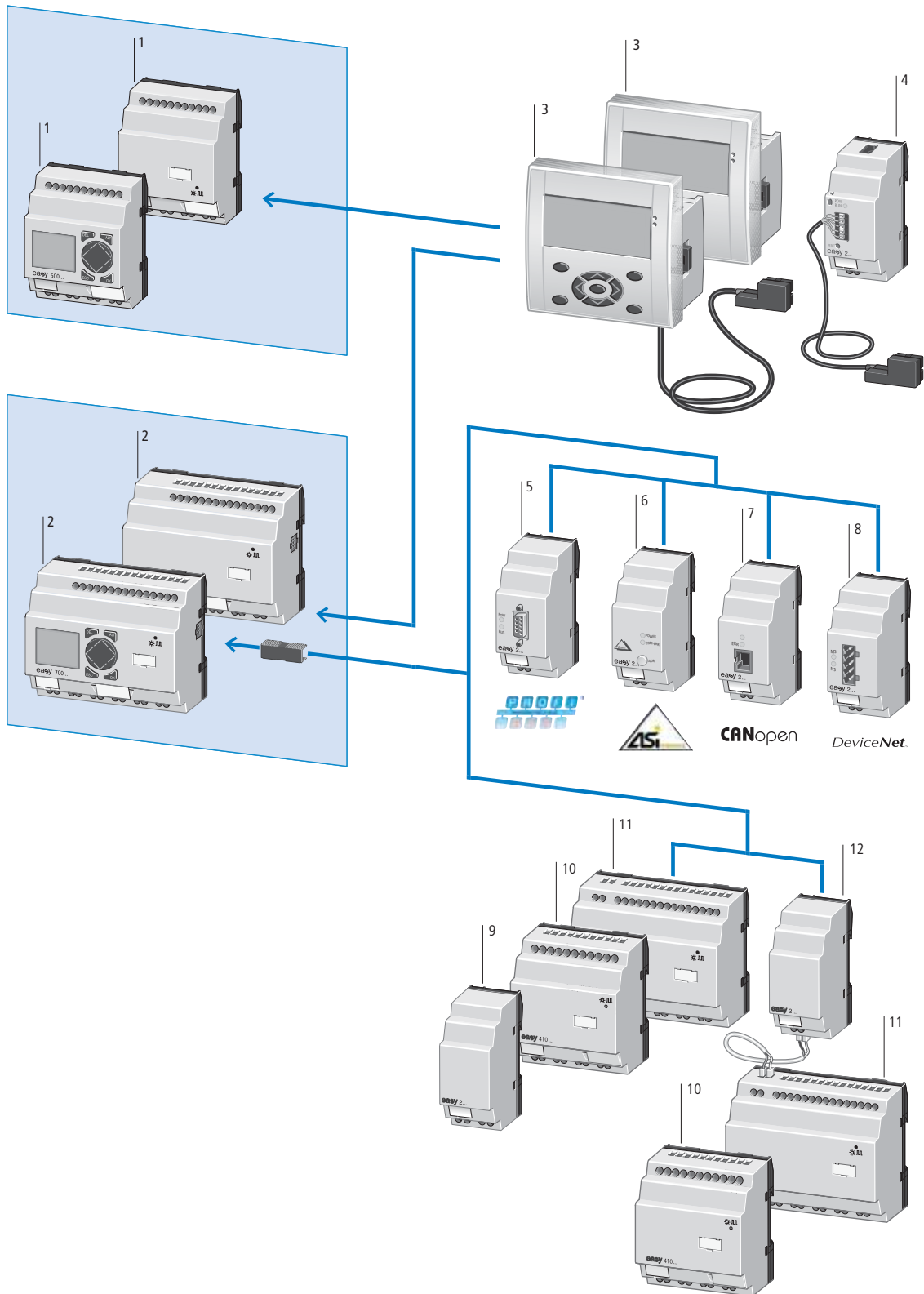

Figure 1: easy basic units and expansion devices

Legend for figure 1:

- ① easy500 basic unit
- ② easy700 basic device with EASY-LINK-DS data connector
- ③ Detachable text display consists of MFD-80(-B) and MFD(-AC)-CP4-500
- ④ EASY209-SE ethernet gateway, connection via the serial multi-function interface
- ⑤ EASY204-DP PROFIBUS-DP slave gateway
- ⑥ EASY205-ASI AS-Interface slave gateway
- ⑦ EASY221-CO CANopen gateway
- ⑧ EASY222-DN DeviceNet gateway
- ⑨ EASY202-RE output expansion
- ⑩ I/O expansion EASY410-DC-...
- ⑪ I/O expansion EASY6...-...-E
- ⑫ EASY200-EASY coupling device

easy is an electronic control relay with logic functions, timer, counter and time switch functions. It is also a control and input device in one, that can perform many different tasks in domestic applications as well as in machine building and plant construction.

easy ensures correct functioning at the start and during operation by executing internal tests and with the help of various timeout watchdogs, (→ Table 34:, Page 192).

Circuit diagrams are connected up using ladder diagrams. and each element is entered directly via the easy display. You can:

- Connect N/O and N/C contacts in series and in parallel
- switch output relays and auxiliary relays,
- Use outputs as relays, impulse relays or latching relays,
- Use multi-function timing relays with different functions,
- Use up and down counters,
- Count high-speed counter pulses,
- Measure frequencies,
- Process analog inputs, easy-AB, easy-DA, easy-DC, (EASY512...: two analog inputs, easy700: four analog inputs),
- Display any texts with variables, enter setpoints,
- Use year time switches, weekly timer, EASY...-...-C(X),
- Count operating hours (four retentive operating hours counters are integrated),
- trace the power flow in the circuit diagram,
- load, store and password protect a circuit diagram.

If you wish to wire easy via your PC, use the easySoft-Basic or easySoft-Pro programming software. easySoft allows you to create and test your program (circuit diagram) on the PC. It also allows you to print out your circuit diagram in DIN/IEC, ANSI/CSA or easy format.

1.4 Versions

easy basic units at a glance

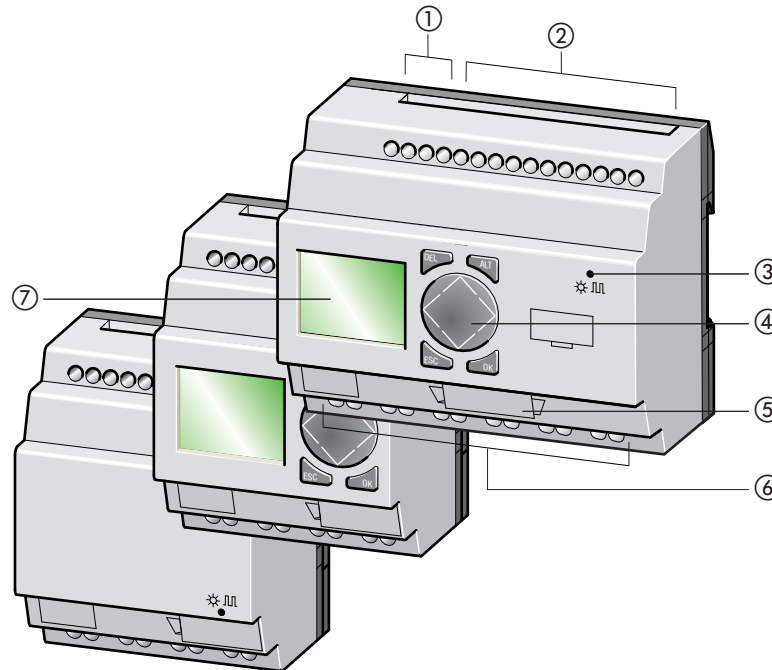

Figure 2: Versions

- ① Supply voltage connection
- ② Inputs
- ③ Status LED
- ④ Keypad
- ⑤ Interface socket for memory card or PC connection
- ⑥ Outputs
- ⑦ Display

easy basic units with stand-alone MFD-80..., MFD-CP4-500 HMI unit

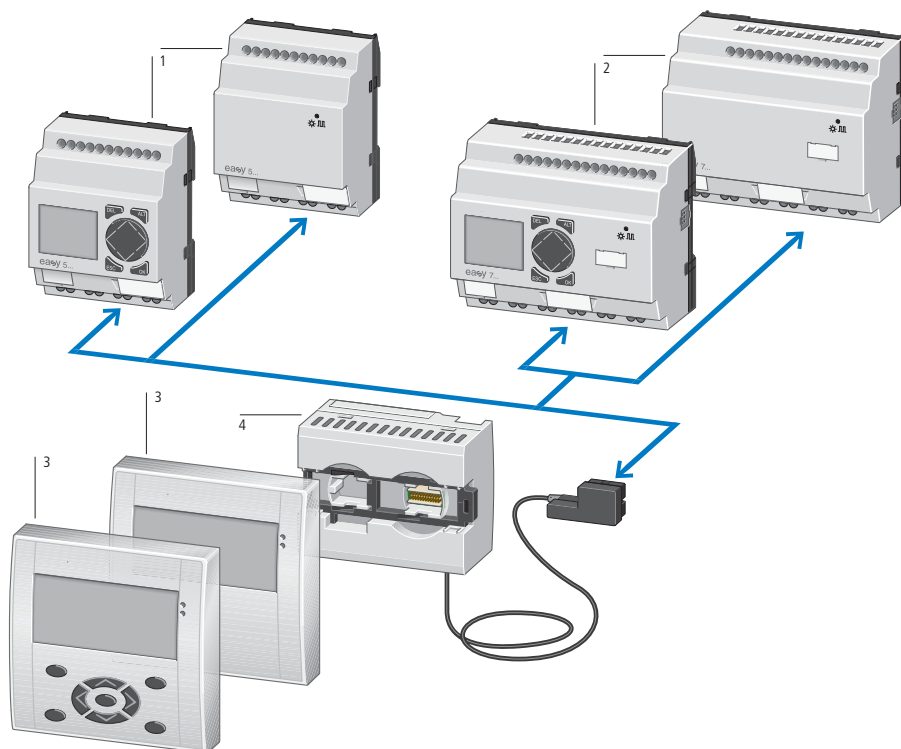

Figure 3: Overview with stand-alone HMI unit

- ① easy500 basic units
- ② easy700 basic units
- ③ Display/operating unit MFD-80(-B)
- ④ Power supply/communication module with MFD(-AC)-CP4-500 interface cable

1.4.1 Key to part numbers

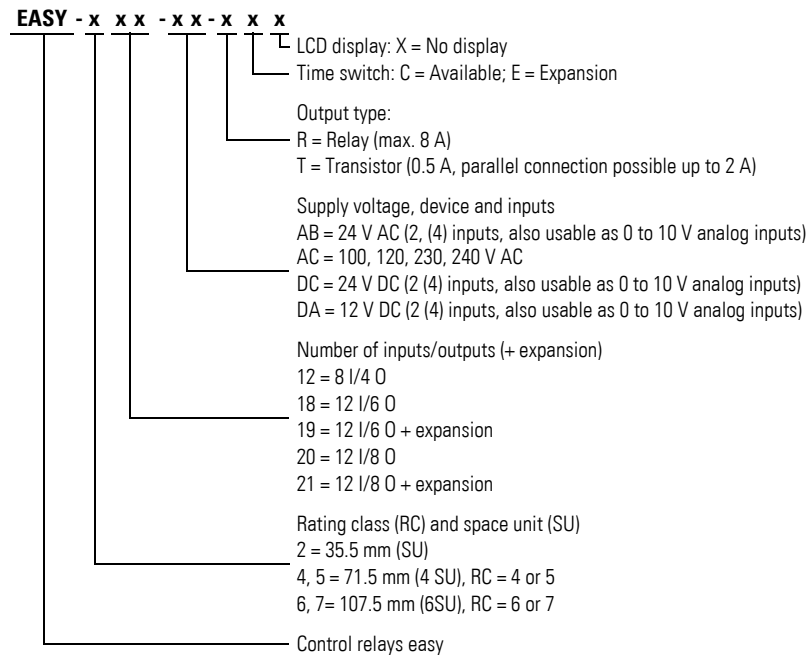
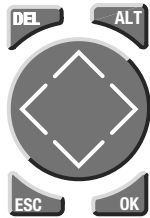

Table 1: Overview of comparable easy400 types with easy500 and easy600 with easy700

| easy400, easy600 | easy500, easy700 |
|------------------|------------------|
| – | EASY512-AB-RC |
| – | EASY512-AB-RCX |
| EASY412-AC-R | EASY512-AC-R |
| EASY412-AC-RC | EASY512-AC-RC |
| EASY412-AC-RCX | EASY512-AC-RCX |
| EASY412-DA-RC | EASY512-DA-RC |
| EASY412-DA-RCX | EASY512-DA-RCX |
| EASY412-DC-R | EASY512-DC-R |
| EASY412-DC-RC | EASY512-DC-RC |
| EASY412-DC-RCX | EASY512-DC-RCX |
| EASY412-DC-TC | EASY512-DC-TC |
| EASY412-DC-TCX | EASY512-DC-TCX |
| – | EASY719-AB-RC |
| – | EASY719-AB-RCX |
| EASY619-AC-RC | EASY719-AC-RC |
| EASY619-AC-RCX | EASY719-AC-RCX |
| – | EASY719-DA-RC |
| – | EASY719-DA-RCX |
| EASY619-DC-RC | EASY719-DC-RC |
| EASY619-DC-RCX | EASY719-DC-RCX |
| EASY621-DC-TC | EASY721-DC-TC |
| EASY621-DC-TCX | EASY721-DC-TCX |

1.5 easyoperating principles

1.5.1 Key Pad



DEL: Delete object in circuit diagram

ALT: Special functions in circuit diagram, Status display

Cursor buttons <> ^∨:

Move cursor

Select menu items

Set contact numbers, contacts and values

OK: Next menu level, Save your entry

ESC: Previous menu level, Cancel

1.5.2 Selecting menus and entering values



Calling the System menu



Move to next menu level Call menu item Activate, change, store entries



Move to previous menu level

Cancel entries since last **OK**



^∨ Change menu item

Change value

<> Change place

P button function:

< Input P1,

> Input P3,

^ Input P2

∨ Input P4

1 easy

1.5 easyoperating principles

1.5.3 Choosing the main and system menu

1.5.3.1 Status indicator

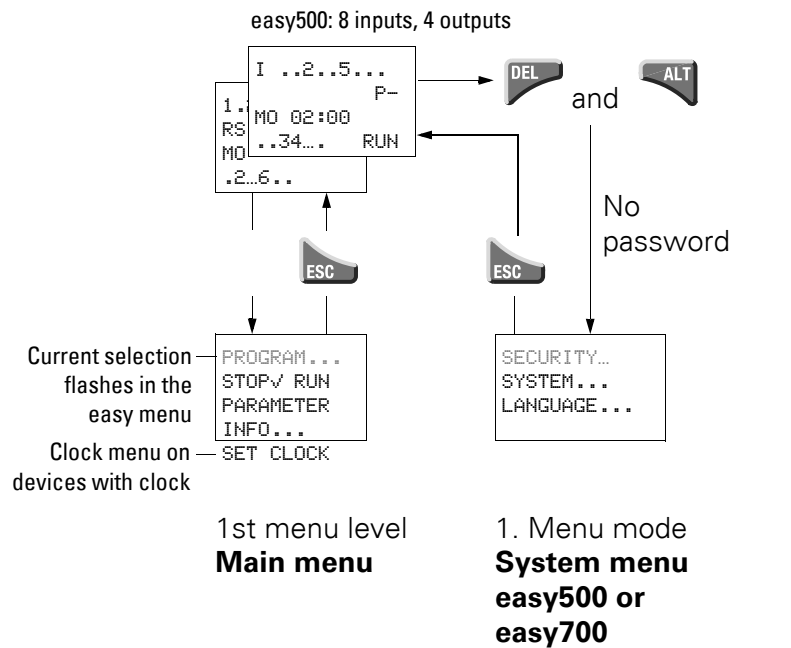

```
SECURITY...
SYSTEM...
LANGUAGE...
CONFIGURATOR
```

The CONFIGURATOR menu appears if a configurable expansion module is connected such as EASY204-DP (Profibus-DP bus gateway)

1.5.3.2 Toggling between weekday, time display and date display

(only on devices with clock)

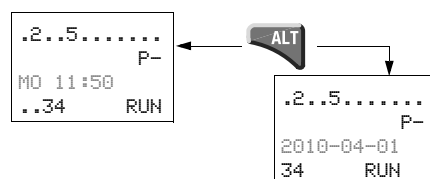

1.5.4 Status indicator easy

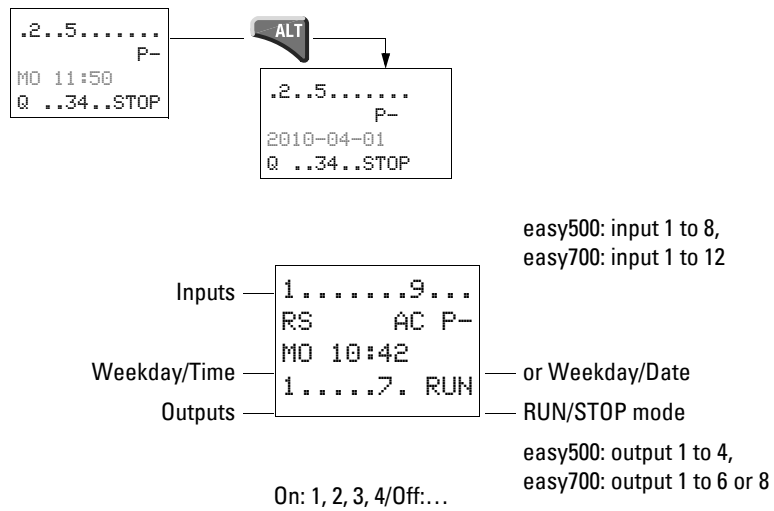

1.5.5 Status display for local expansion

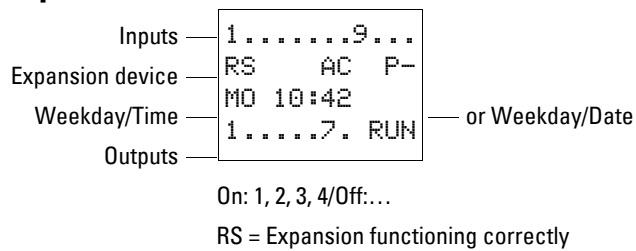

1.5.6 Advanced Status display

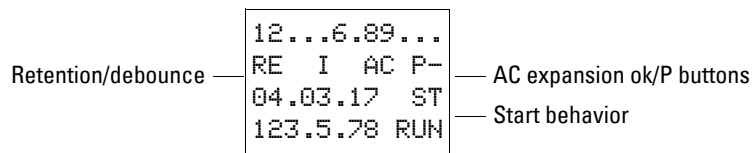

- RE : Retention switched on
- I : Debounce switched on
- AC : AC expansion functioning correctly
- DC : DC expansion functioning correctly
- GM : Bus coupling module detected
- GW flashes: Only easy200-easy detected. I/O expansion not detected.
- 04.03.17 Display of actual device date
- ST : When the power supply is switched on, easy switches to STOP mode

1.5.7 easyLED display

EASY512-...-...X, easy700 and easy-E feature an LED on the front indicating the status of the power supply as well as whether RUN or STOP mode is active (→, page12).

| | |
|----------------------|---------------------------------|
| LED OFF | No supply voltage |
| LED continuously lit | Power supply present, STOP mode |
| LED flashing | Power supply present, RUN mode |

1.5.8 Menu structure

1.5.8.1 Main menu without password protection

► You access the main menu by pressing **OK**.

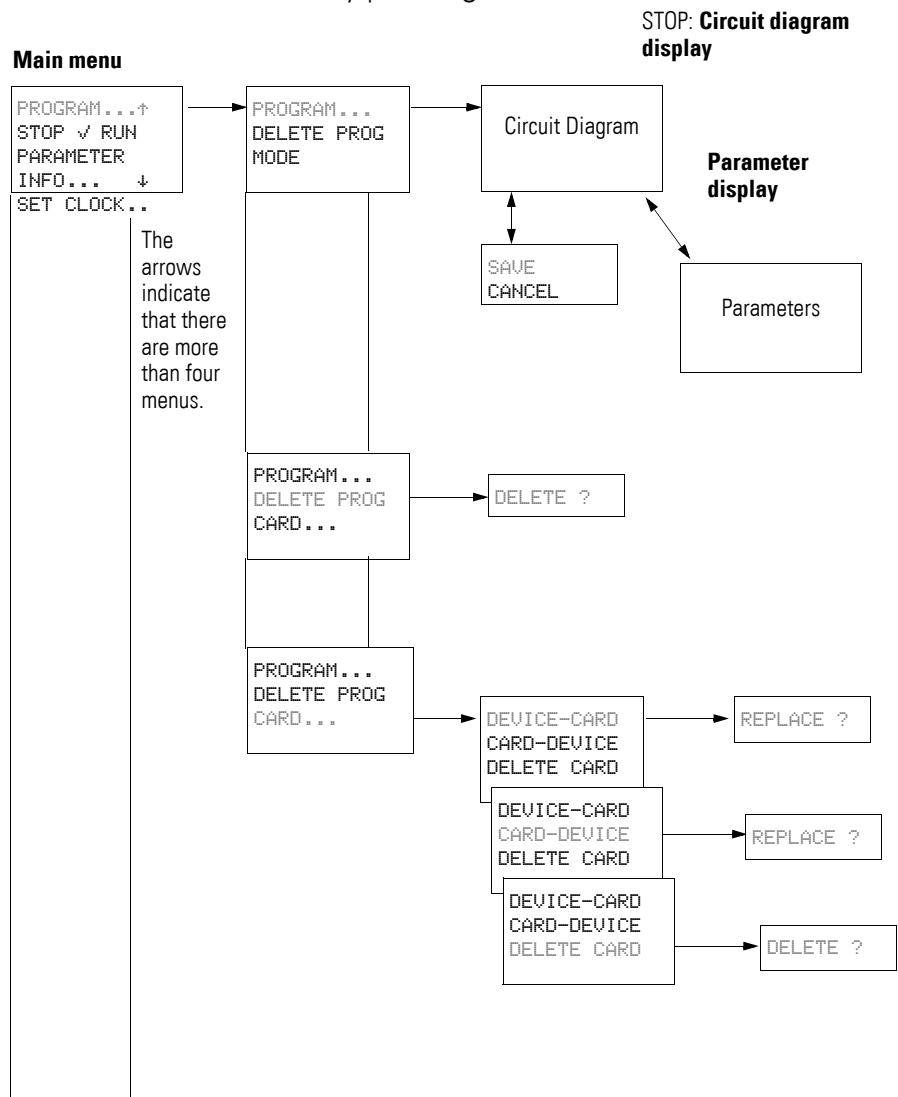

Main menu

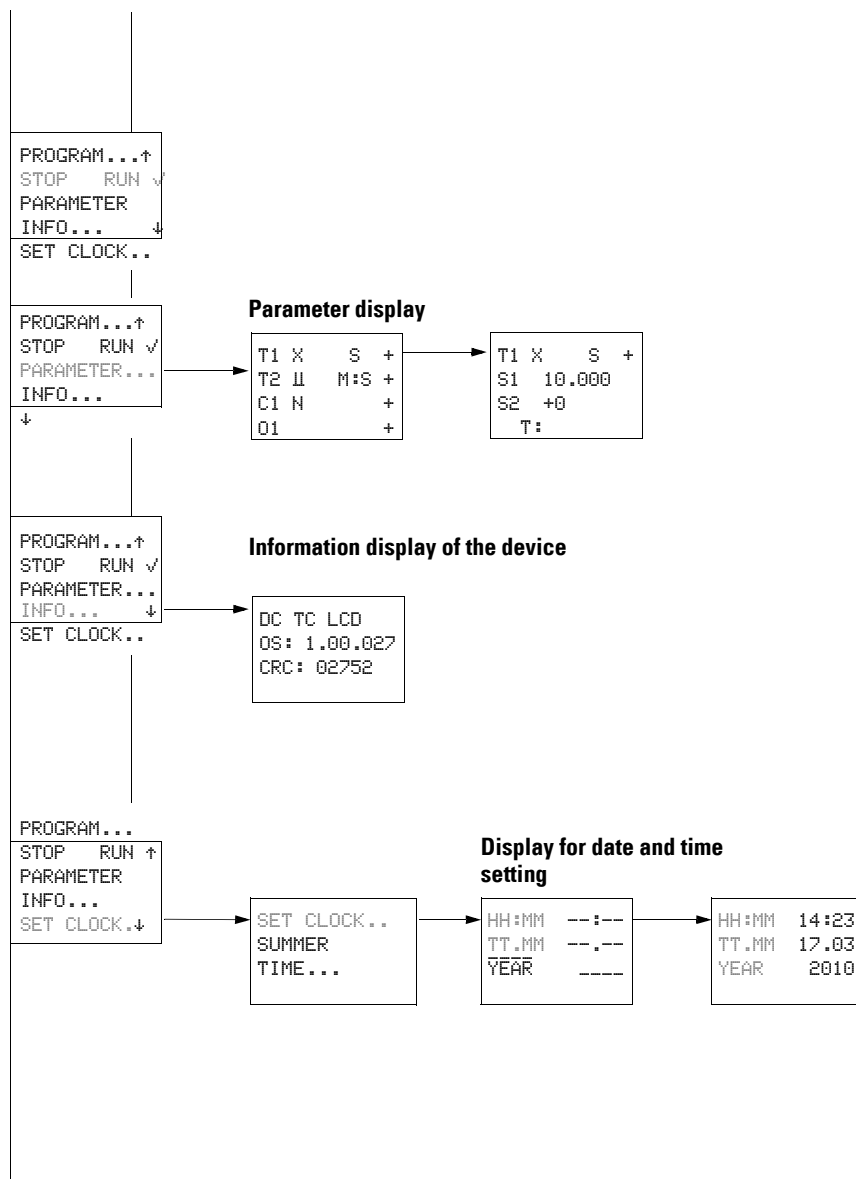

1 easy
1.5 easyoperating principles

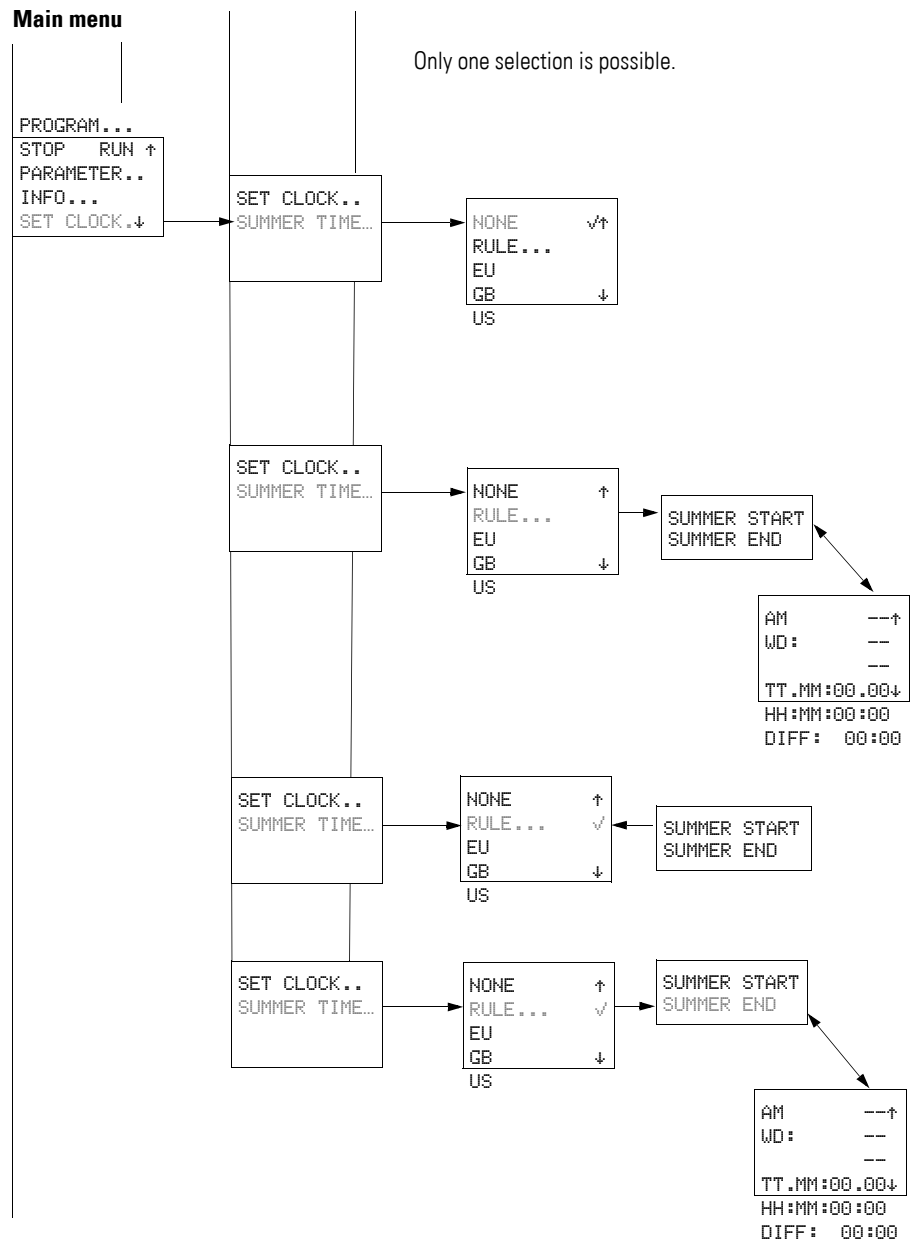

1.5.8.2 Main menu with password protection

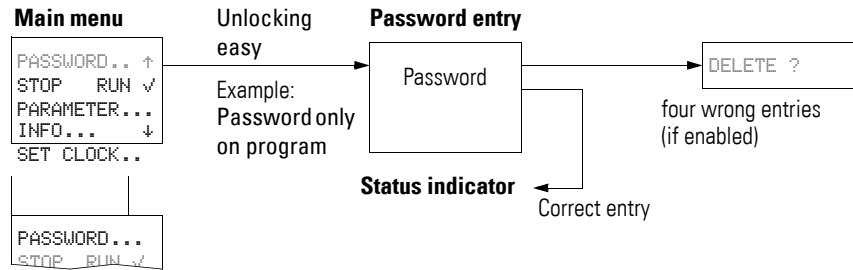

1.5.8.3 System menu easy

The System menu is accessed by simultaneously pressing **DEL** and **ALT**.

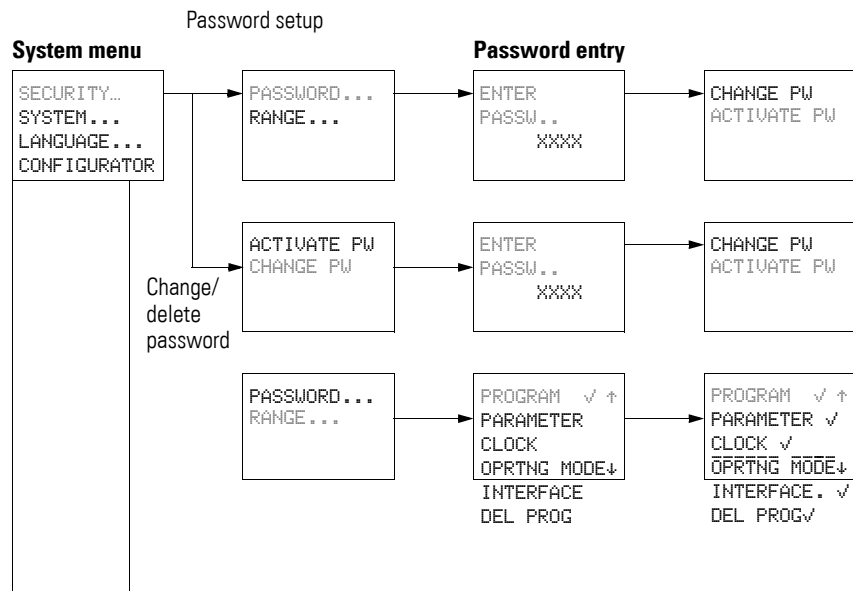

1 easy

1.5 easyoperating principles

System menu

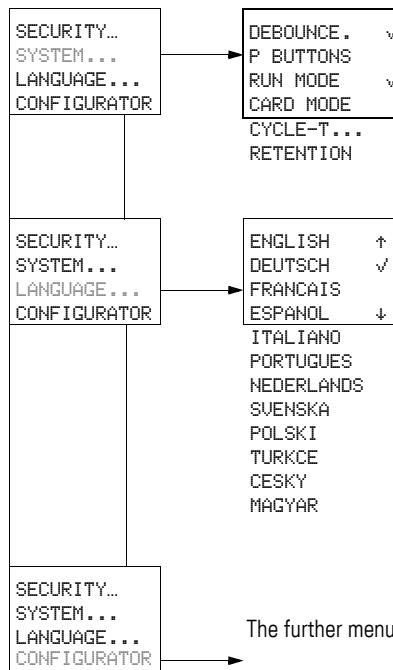

Only one selection is possible.

The further menus depend on the connected expansion device.

1.5.9 Selecting or toggling between menu items

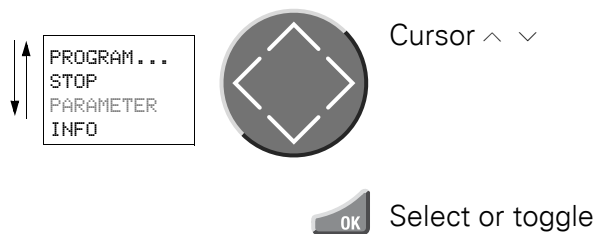

1.5.10 Cursor display

HH:MM ■4:23
TT.MM 17.03
YEAR 2010

The cursor flashes.

Full cursor ■/:

- Move cursor with < > ,
- in circuit diagram also with ^ v

HH:MM 14:23
TT.MM 17.03
YEAR 2010

Value M/M

- Change position with < >
- Change values with ^ v

Flashing values/menus are shown in grey in this manual.

1.5.11 Set value

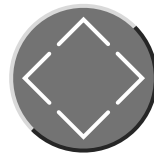
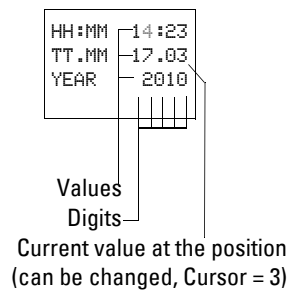

- Select value ^ v
- Select digit < >
- Change value at digit ^ v



Store entries



Retain previous value

1 easy

1.5 easyoperating principles

2 Installation

easy must only be installed and wired up by trained electricians or other persons familiar with the installation of electrical equipment.



DANGER

Never carry out electrical work on the device while the power supply is switched on, there is **danger** of electric shock.

Always follow the safety rules:

- Switch off and isolate
- Secure against retriggering.
- Verify isolation from the supply.
- Cover adjacent live parts.

easy is installed in the following order:

- Assemble devices if necessary,
- Mounting,
- Wiring up the inputs,
- Wiring up the outputs,
- Connecting the power supply.

2 Installation

2.1 Mounting

2.1 Mounting

Install the easy in a control cabinet, service distribution board or in an enclosure so that the power supply and terminal connections cannot be touched accidentally during operation.

Clip easy onto a DIN EN 50022 top-hat rail or fix easy in place using fixing brackets. easy can be mounted vertically or horizontally.



When using easy with expansion units, connect the expansion concerned before mounting (→ section “2.2 Connecting the expansion device”, page 28).

For ease of wiring, leave a gap of at least 30 mm between easy terminals and the wall or adjacent devices.

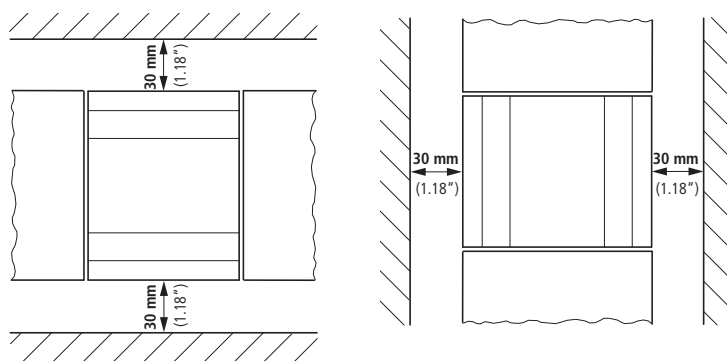
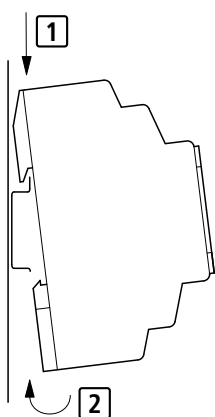

Figure 4: Clearances to easy

2.1.1 Mounting on top-hat rail



- ▶ Hook easy to the top edge of the top-hat rail and hinge into place while pressing down slightly. Press down lightly on both the device and the top-hat rail until the unit snaps over the lower edge of the top-hat rail. Easy will clip into place and will be secured by the built-in spring mechanism.
- ▶ Check that the device is seated firmly.
The device is mounted vertically on a top-hat rail in the same way.

2.1.2 Screw mounting

Mounting on a mounting plate requires the use of fixing brackets which are fixed to the back of easy. The fixing brackets are available as an accessory.

easy600 and easy700: Fasten each device with at least three fixing brackets.

EASY200-EASY:

easy500:

easy600, easy700:

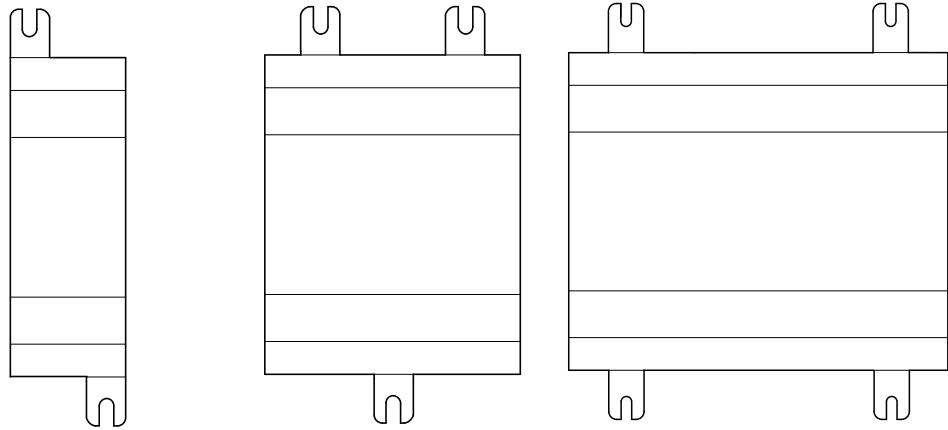

Figure 5: Screw mounting

2 Installation

2.2 Connecting the expansion device

2.2 Connecting the expansion device

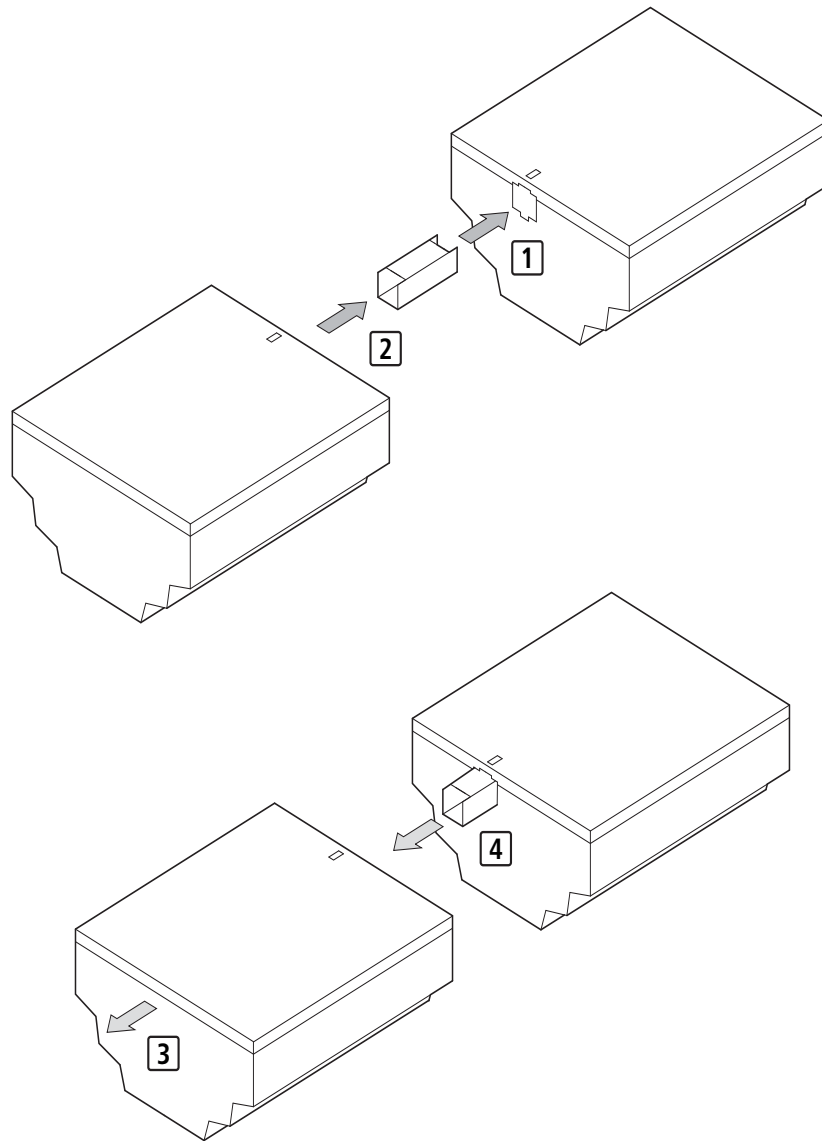

Figure 6: Connecting expansion units

- ▶ Open the easy-Link connections on the side of both easy devices.
- ▶ Fit the easyLink data connector EASY-LINK-DS in the opening provided on the expansion device.
- ▶ Plug the devices together.
- ▶ Proceed in the reverse order to dismantle the device.

2.3 Terminations

2.3.1 Tools

Slot-head screwdriver, width 3.5 mm, tightening torque 0.6 Nm.

2.3.2 Cable cross-sections

- Solid: 0.2 to 4 mm²
- Flexible with ferrule: 0.2 to 2.5 mm²

2.4 Connecting the power supply



The required connection data for device types, **easy-AB with 24 V AC**, **easy-AC** with standard voltages of 100 V AC up to 240 V AC, **easy-DA** with 12 V DC and **easy-DC** with 24 V DC are provided in the (→ section "8.3 Technical data", page 210).

The easy500 and easy700 basic units run a system test for two seconds after the power supply has been switched on. Either RUN or STOP mode will be activated after these two seconds, depending on the default setting.

2.4.1 Cable protection

Connect on easy a cable protection (F1) rated for at least 1 A (slow).



When easy is switched on for the first time, its power supply circuit behaves like a capacitor. Ensure that reed relay contacts or proximity switches are not used as the switching device for switching on the power supply.

2.4.2 Supplying AC basic units

EASY...-AB-RC(RCX), EASY...-AC-R(RC, RCX)

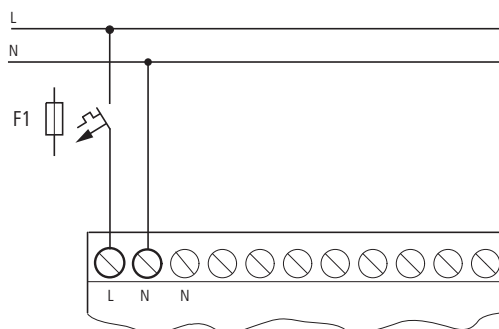

Figure 7: Supply voltage to AC basic unit

2 Installation

2.4 Connecting the power supply

2.4.3 Supplying AC expansion units

EASY...-AC-E

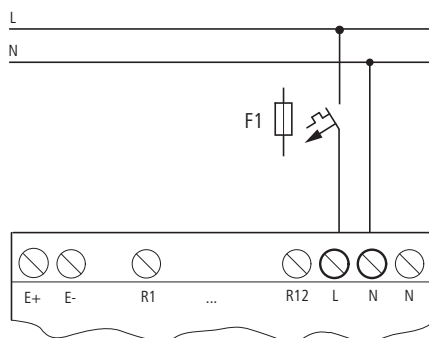

Figure 8: Power supply on the AC expansion units



WARNING

Ensure the proper connection of the L phase conductor and N neutral conductor if you are using easy-AS devices with a power supply greater than 24 V AC!

If the L phase conductor and N neutral conductor **connections are reversed**, the full connection voltage of the L phase conductor (100 to 240 V AC) is present on the serial multi-function interface.

Improper connection on the multi-function interface or the insertion of conductive objects in the shaft may cause fatal electric shock.

For your safety:

- Use the original programming cable, which ensures safe electrical isolation of the PC terminal from the connection voltage of the L phase conductor (100 to 240 V AC).

Press the interface cover back onto the shaft if you no longer need the interface.

CAUTION

A short current surge will be produced when switching on for the first time. Do not switch on easy with reed contacts because these could possibly burn or stick.

2.4.4 Supplying DC basic units

EASY...-DA-RC(X), EASY...-DC-R(RC,RCX)

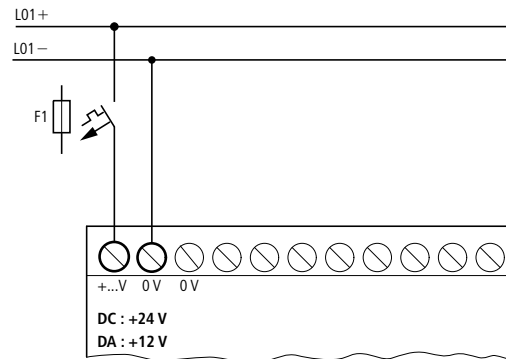

Figure 9: Power supply on the DC basic units

2.4.5 Supplying DC expansion devices

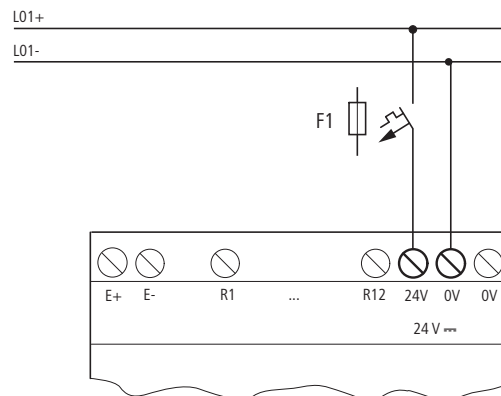

Figure 10: Power supply on the DC expansion units



easy-DC and easy-DA are protected against reverse polarity. To ensure that easy works correctly, ensure that the polarity of each terminal is correct.

2.5 Connecting inputs

easy inputs switch electronically. Once you have connected a contact via an input terminal, you can reuse it as a contact in your easy circuit diagram as often as you like.

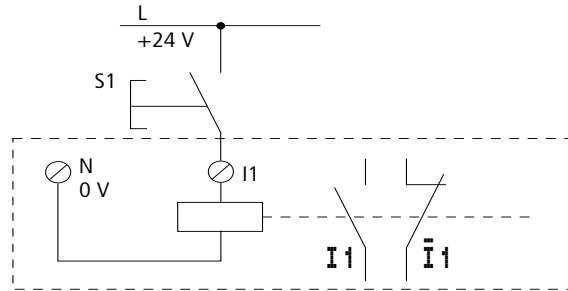

Figure 11: Connecting inputs

Connect to the easy input terminals contacts such as pushbuttons, switches, relay or contactor contacts, proximity switches (three-wire).

2.5.1 Connect digital AC inputs



WARNING

Connect the inputs on AC devices according to the VDE, IEC, UL and CSA safety requirements. To supply the inputs, use the same main pole to which the power supply of the device is connected. easy will otherwise not detect the signal level and may be destroyed by overvoltage.

2.5.1.1 Connect digital AC inputs to the basic unit

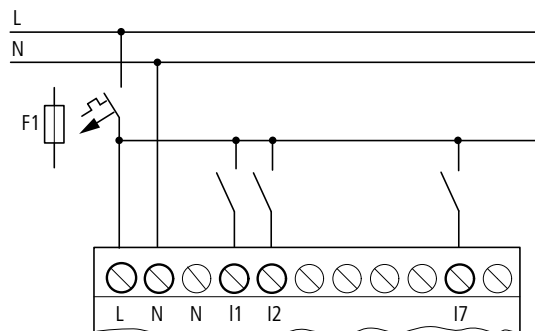

Figure 12: Connecting easy-AC and easy-AB digital inputs

2.5.1.2 Connect digital AC inputs to the expansion unit

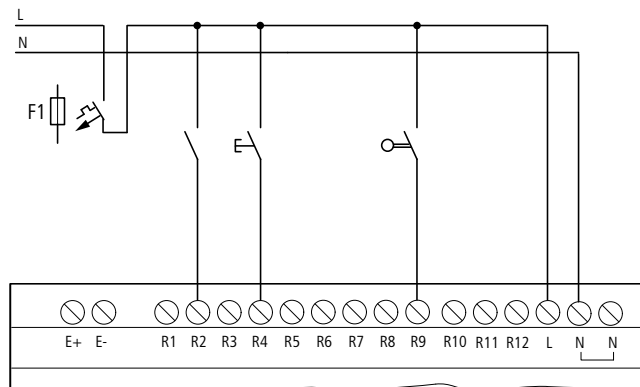

Figure 13: Connecting EASY...-AC-E digital inputs

Table 2: easy-AB input signal values

| | | Voltage range of the input signals | | Input current |
|---------------------|----------|------------------------------------|-------------------------------------|-------------------------------|
| | | OFF signal | ON signal | |
| easy500/ easy700 | I1 - I6 | 0 - 6 V AC | 14 - 26.4 V AC | 4 mA at 24 V AC |
| | I7, I8 | | ≥ 7 V AC or ≥ 9.5 V DC | 2 mA with 24 V AC and 24 V DC |
| easy700 | I9, I10 | 0 - 6 V AC | 14 to 26.4 V AC | 4 mA at 24 V AC |
| | I11, I12 | | ≥ 7 V AC or ≥ 9.5 V DC | 2 mA with 24 V AC and 24 V DC |

Table 3: easy-AC input signals

| | | Voltage range of the input signals | | Input current |
|---------------------|----------|------------------------------------|------------|--|
| | | OFF signal | ON signal | |
| easy500/ easy700 | I1 - I6 | 0 - 40 V | 79 - 264 V | 0.5 mA at 230 V AC/0.25 mA at 115 V AC |
| | I7, I8 | | | 6 mA at 230 V AC/4 mA at 115 V |
| easy700 | I9 - I12 | 0 - 40 V | 79 - 264 V | 0.5 mA at 230 V AC/0.25 mA at 115 V AC |
| easy600 | R1 - R12 | | | |

2 Installation

2.5 Connecting inputs

2.5.1.3 Cable lengths

Severe interference can cause a signal 1 on the inputs without a proper signal being applied. Observe therefore the following maximum cable lengths:

| | |
|-----------|----------------------------------|
| I1 to I6 | 40 m without additional circuit |
| I7, I8 | 100 m without additional circuit |
| I9 to I12 | 40 m without additional circuit |
| R1 to R12 | |

With longer cables you can, for example, connect a 1A diode (e.g. 1N4007) with a blocking voltage of at least 1000 V in series with the easy input. Ensure that the diode is pointing towards the input as shown in the circuit diagram, otherwise easy will not detect the 1 state.

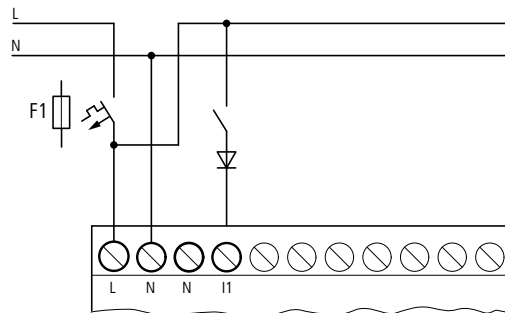

Figure 14: AC input with suppression diode for easy-AC and easy-AB

easy-AC:

Inputs I7 and I8 have a higher input current on the easy-AC. Neon bulbs with a maximum residual current of 2 mA/1 mA at 230 V/115 V can be connected to I7 and I8.



Always use neon bulbs that are operated with a separate N connection.



WARNING

Do not use reed relay contacts at I7, I8. These may burn or melt due to the high inrush current of I7, I8.

Two-wire proximity switches have a residual current with the "0" state. If this residual current is too high, the easy input may only detect a "1" signal.

Use therefore the inputs I7, I8. An additional input circuit is required if more inputs are needed.

2.5.1.4 Increased input current

The following input circuit can be used in order to prevent interference and also when using two-wire proximity switches:

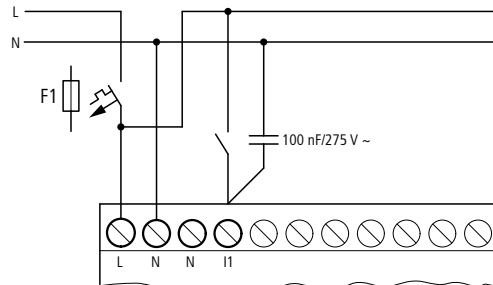

Figure 15: Increased input current



When using a 100 nF capacitor, the drop-out time of the input increases by 80 (66.6) ms at 50 (60) Hz.

A resistor can be connected in series with the circuit shown in order to restrict the inrush current.

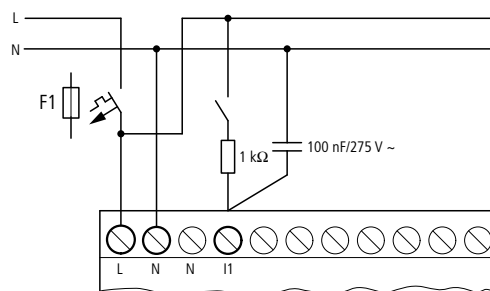

Figure 16: Limitation of the input current through resistors

Complete devices for increasing the input current are available under the part no. EASY256-HCI.

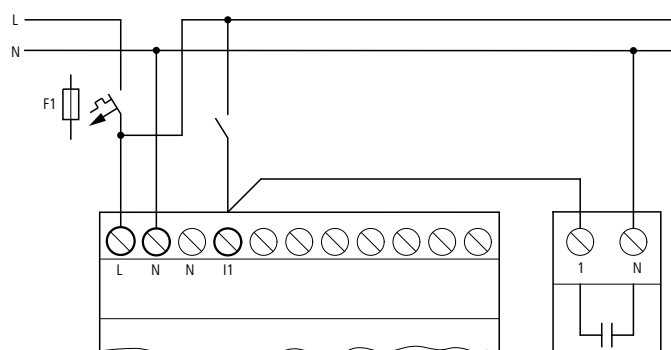

Figure 17: easy with EASY256-HCI



The increased capacitance increases the drop-off time by approx. 40 ms.

2 Installation

2.5 Connecting inputs

2.5.2 Connecting easy DC digital inputs

Use input terminals I1 to I12, R1 to R12 to connect pushbutton actuators, switches or 3 or 4-wire proximity switches. Given the high residual current, do not use 2-wire proximity switches.

2.5.2.1 Connecting DC digital inputs on the basic unit

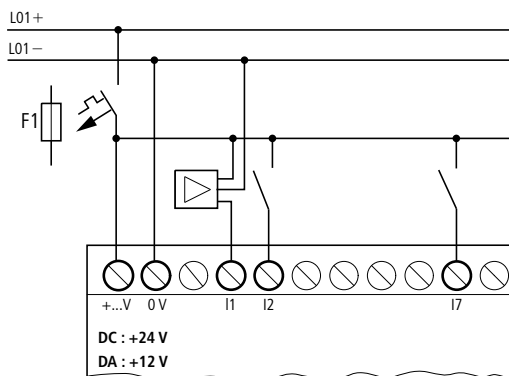

Figure 18: Connecting easy-DC, easy-DA digital inputs

2.5.2.2 Connect digital DC inputs to the expansion unit

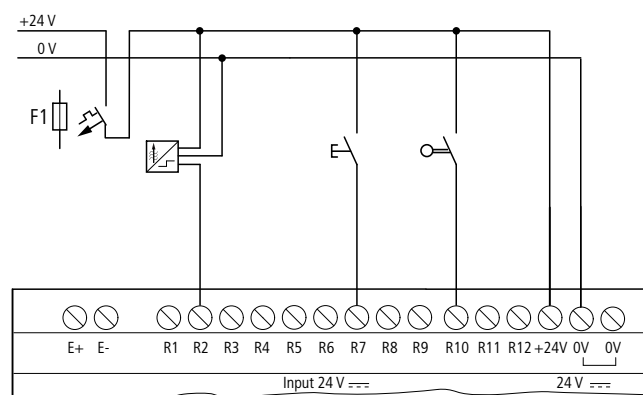

Figure 19: Connecting EASY...-DC-E digital inputs

Table 4: easy-DC input signals

| | | Voltage range of the input signals | | Input current |
|---------------------|----------|------------------------------------|-------------|-------------------|
| | | OFF signal | ON signal | |
| easy500/ easy700 | I1 to I6 | 0 - 5 V | 15 - 28.8 V | 3.3 mA at 24 V DC |
| | I7, I8 | | ≥ 8 V DC | 2.2 mA at 24 V |
| easy700 | I9, I10 | | 15 - 28.8 V | 3.3 mA at 24 V DC |
| | I11, I12 | | ≥ 8 V DC | 2.2 mA at 24 V |
| easy600 | R1 - R12 | | 15 - 28.8 V | 3.3 mA at 24 V DC |

Table 5: easy-DA input signals

| | | Voltage range of the input signals | | Input current |
|---------------------|----------|------------------------------------|---------------|----------------|
| | | OFF signal | ON signal | |
| easy500/ easy700 | I1 -I6 | 0-4 V DC | 8 - 15.6 V DC | 3.3 mA at 12 V |
| | I7, I8 | | | 1.1 mA at 12 V |
| easy700 | I9, I10 | | | 3.3 mA at 12 V |
| | I11, I12 | | | 1.1 mA at 12 V |

2.5.3 Connecting analog inputs

The easy-AB, easy-DA and easy-DC basic units are provided with analog inputs. Inputs I7 and I8, and if present I11 and I12, can be used to connect analog voltages ranging from 0 V to 10 V. A simple additional circuit also allows the analog evaluation of currents from 0 to 20 mA. The analog input signals are converted to 10-bit digital signals.

The following applies:

- 0 V DC corresponds to a digital 0.
- 5 V DC corresponds to a digital value of 512.
- 10 V DC corresponds to a digital value of 1023.



WARNING

Analog signals are more sensitive to interference than digital signals. Consequently, greater care must be taken when laying and connecting the signal lines. Incorrect connection may lead to unwanted switching states.

2.5.3.1 Safety measures with analog signals

- ▶ Use screened, twisted pair conductors, to stop interference of the analogue signals.
- ▶ For short cable lengths, ground the shield at both ends using a large contact area. If the cable length is more than around 30 m, grounding at both ends can result in equalization currents between the two grounding points and thus in the interference of analog signals. In this case, only ground the cable at one end.
- ▶ Do not lay signal cables parallel to power cables.
- ▶ Connect inductive loads to be switched via the easy outputs to a separate supply voltage, or use a suppressor circuit for motors and valves. Supplying loads such as motors, solenoid valves or contactors and easy from the same supply voltage may cause interference of the analog input signal when switching.

2 Installation

2.5 Connecting inputs

The following four circuits contain examples of applications for analog value processing.



WARNING

Ensure that the reference potential is connected. Connect the 0 V of the power supply unit for the different setpoint potentiometers and sensors shown in the examples to the 0 V and neutral conductor terminal (easy-AB) of the easy power supply. Otherwise incorrect switching states may occur if they are not connected correctly.

2.5.3.2 Power supply of easy-AB devices and analog inputs

With easy-AB devices that process analog signals, the device must be fed via a transformer so that the device is isolated from the mains supply. The neutral conductor and the reference potential of the DC power feed of analog sensors must be electrically connected.



Ensure that the common reference potential is grounded or monitored by a ground fault monitoring device. Observe the applicable regulations.

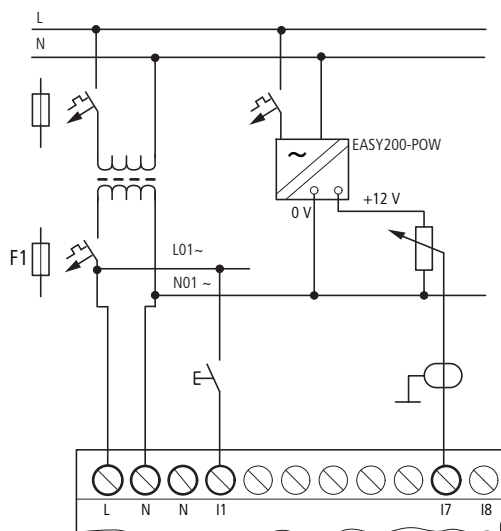

Figure 20: easy-AB analog input, connection of reference potentials

2.5.3.3 Analog setpoint potentiometer, easy-AB, easy-DA, easy-DC

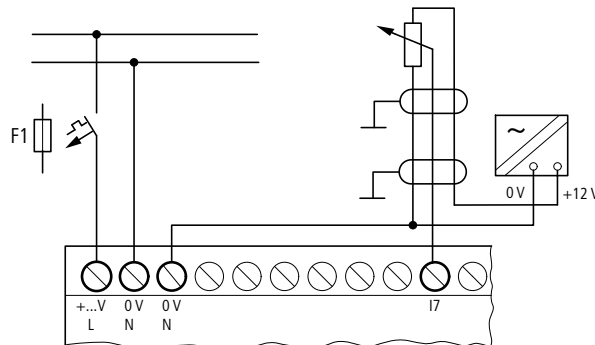

Figure 21: Analog setpoint potentiometer with own power feed

Use a potentiometer with the resistance $\leq 1 \text{ k}\Omega$, e.g. $1 \text{ k}\Omega$, 0.25 W .

2.5.3.4 easy-DC analog setpoint potentiometer

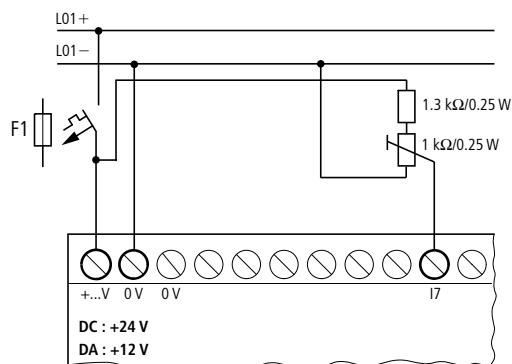

Figure 22: Analog setpoint potentiometer with 24 V DC power feed

2.5.3.5 Brightness sensor easy-AB, easy-DA, easy-DC

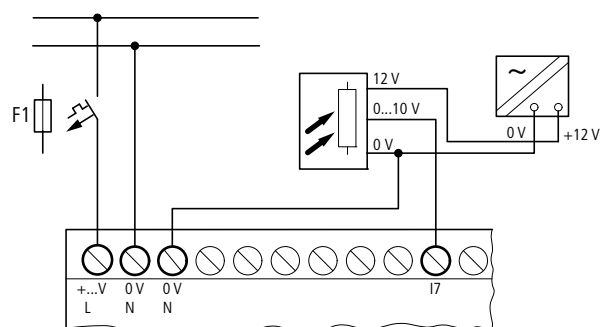

Figure 23: Connection of a brightness sensor, analog input

2 Installation

2.5 Connecting inputs

2.5.3.6 Temperature sensor, easy-DA, easy-DC

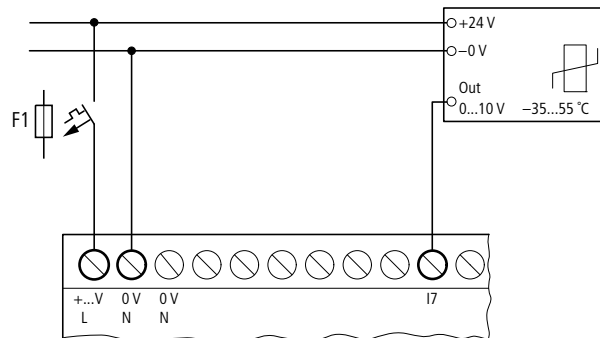

Figure 24: Connection of the temperature sensor, analog input

2.5.3.7 20 mA sensor

4 to 20 mA (0 to 20 mA) sensors can be connected easily without any problem using an external 500 Ω resistor.

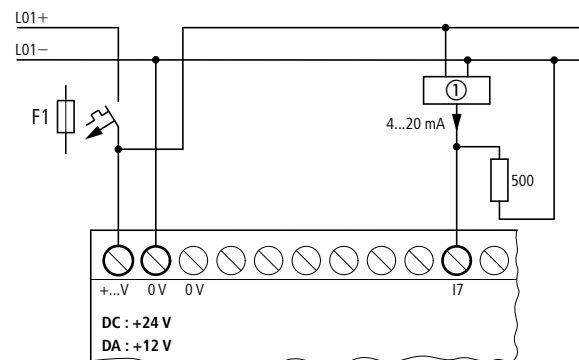

Figure 25: Connection 0 (4) to 20 mA sensor output, analog input

① Analog sensor

The following values apply:

- 4 mA = 1.9 V
- 10 mA = 4.8 V
- 20 mA = 9.5 V

(according to $U = R \times I = 478 \Omega \times 10 \text{ mA} \sim 4.8 \text{ V}$).

2.5.4 Connecting high-speed counters and frequency generators

High-speed counter signals and frequencies on the easy-DA and easy-DA can be counted accurately on inputs I1 to I4 independently of the cycle time. These inputs are permanently assigned to counters.

The following applies:

- I1 = C13 high-speed up/down counter
- I2 = C14 high-speed up/down counter
- I3 = C15 frequency counter
- I4 = C16 frequency counter

Pulse shape of count signals:

easy processes square wave signals.

Mark-to-space ratio of count signals: We recommend a mark-to-space ratio of 1:1.

If this is not the case: The minimum pulse or pause duration is 0.5 ms.

$$t_{\min} = 0.5 \times (1/f_{\max})$$

t_{\min} = minimum time of the pulse or pause duration

f_{\max} = maximum count frequency (1 kHz)

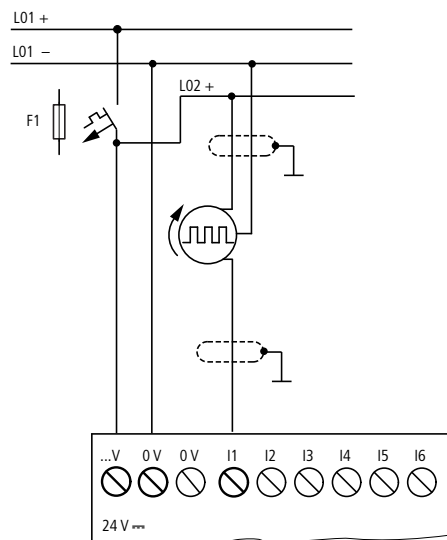

Figure 26: Connecting high-speed counters and frequency generators



Inputs that are used as high-speed counter inputs should not be used in the circuit diagram as contacts. If the counter frequency is high:

Not all the signals of the high-speed counter can be monitored for processing in the circuit diagram. easy will only process a randomly logged state.

2 Installation

2.6 Connecting outputs

2.6 Connecting outputs

The Q outputs operate inside the easy as isolated contacts.

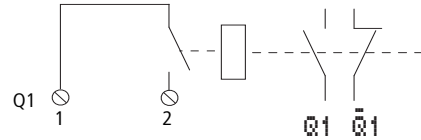

Figure 27: Q output

The associated relay coils are controlled in the easy circuit diagram via the following outputs:

- Q1 to Q4 and Q1 to Q8 (Q6), basic units.
- S1 to S8 (S6), expansion devices.

The signal states of the outputs can be used in the easy circuit diagram as N/O or N/C contacts for other switching conditions.

The relay or transistor outputs are used to switch loads such as fluorescent tubes, filament bulbs, contactors, relays or motors. Prior to installation observe the technical limit values and data for the outputs (→ section "8.3 Technical data", page 210).

2.6.1 Connecting relay outputs

2.6.1.1 EASY512-...-R..

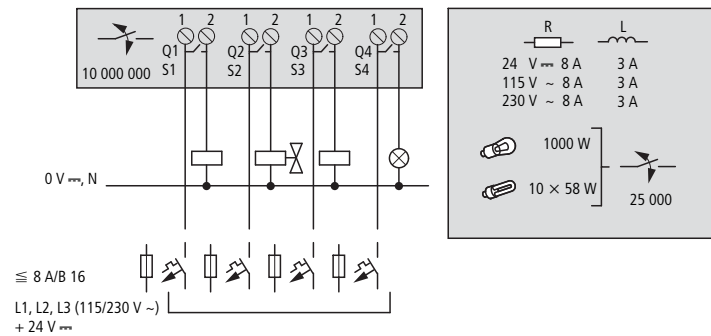

Figure 28: EASY512-...-R... relay outputs

2.6.1.2 EASY7...-R.. and EASY202-RE

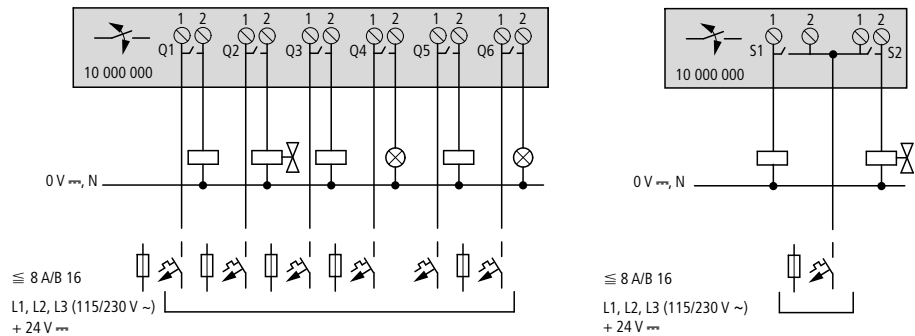

Figure 29: EASY7...-R.. relay outputs and EASY202-RE



The EASY202-RE cannot be operated on an EASY7...-DA-R.. with a 12 V DC power supply.

2.6.1.3 EASY618...-RE

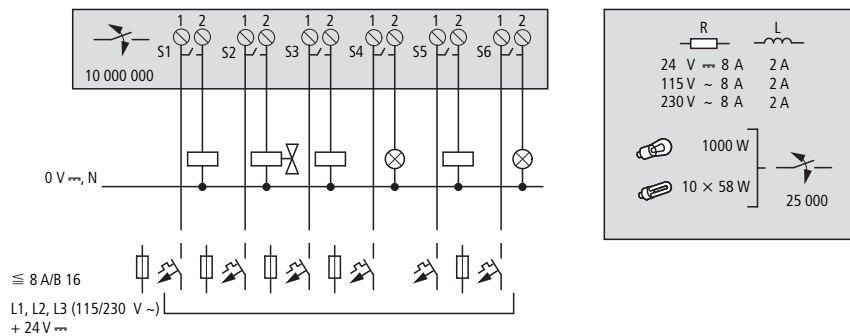

Figure 30: EASY618...-RE... relay outputs

Unlike the inputs, the outputs can be connected to different phases.



DANGER

Do not exceed the maximum voltage of 250 V AC on a relay contact.
If the voltage exceeds this threshold, flashover may occur at the contact, resulting in damage to the device or a connected load.

2 Installation

2.6 Connecting outputs

2.6.2 Connecting transistor outputs

2.6.2.1 EASY512-...-T..

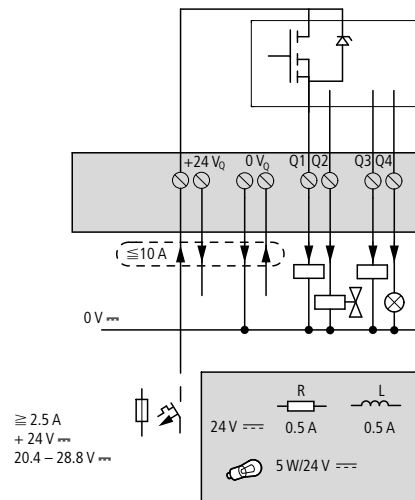

Figure 31: EASY512-...-T... transistor outputs

2.6.2.2 EASY7...-T..

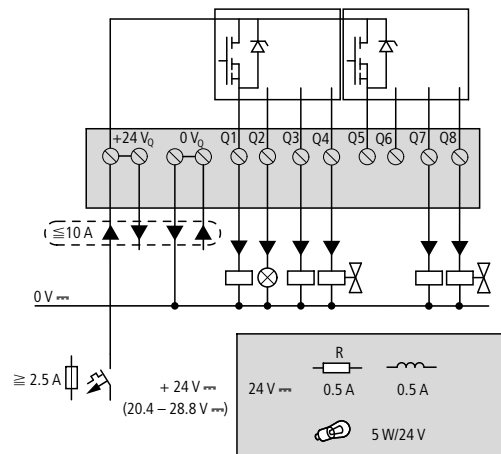

Figure 32: EASY7...-T... transistor outputs

2.6.2.3 EASY620-..-TE

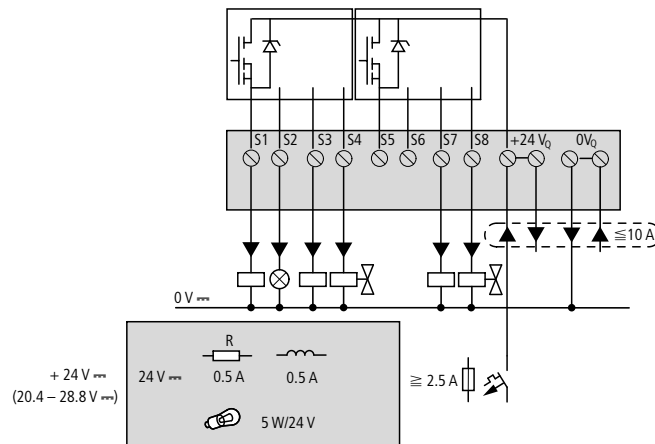

Figure 33: EASY620-...-TE transistor outputs

Parallel connection:

Up to four outputs can be connected in parallel in order to increase the power. This enables a maximum output current of 2 A.



WARNING

The outputs may only be connected in parallel within a group (Q1 to Q4 or Q5 to Q8, S1 to S4 or S5 to S8); Q1 and Q3 or Q5, Q7 and Q8. Parallel outputs must be activated simultaneously.



WARNING

- Please note the following when switching off inductive loads:
- Suppressed inductive loads cause less interference in the entire electrical system. It is generally recommended to connect the suppressor as close as possible to the inductance.

2 Installation

2.7 Expanding inputs/outputs .

If inductive loads are not suppressed, the following applies:

- Several inductive loads should not be switched off simultaneously to avoid overheating the driver blocks in the worst possible case. If in the event of an emergency stop the +24 V DC power supply is to be switched off by means of a contact, and if this would mean switching off more than one controlled output with an inductive load, then you must provide suppressor circuits for these loads (see the following diagrams).

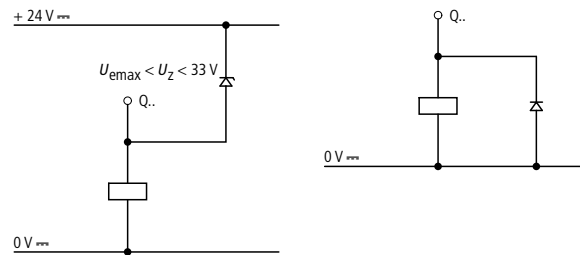

Figure 34: Inductive load with suppressor circuit

2.6.3 Behavior in the event of a short-circuit/overload

Should a short circuit or overload occur on a transistor output, this output will switch off. The output will switch back on up to the maximum temperature after a cooling time that depends on the ambient temperature and the current level. If the fault condition persists, the output will keep switching off and on until the fault is corrected or until the power supply is switched off (→ section “6.4 Monitoring of short-circuit/overload with EASY..-D.-T..”, page 192).

2.7 Expanding inputs/outputs .

You can add expansion units to the following easy700 devices in order to increase the number of inputs and outputs:

| Expandable easy basic units | Expansion Devices | Features |
|---|-------------------|---|
| EASY7...-R.. EASY7...-T.. | EASY410-DC-E | 24 V DC power supply <ul style="list-style-type: none"> • 6 DC inputs, • 4 relay outputs (...-DC-RE) or • 4 Transistor outputs (...-DC-TE) |
| | EASY618...-RE | 115/230 V AC power supply <ul style="list-style-type: none"> • 12 AC inputs, • 6 relay outputs |
| | | 24 V DC power supply <ul style="list-style-type: none"> • 12 DC inputs, • 6 relay outputs |
| | EASY620...-TE | <ul style="list-style-type: none"> • 12 DC inputs, • 8 transistor outputs |
| | EASY202-RE | 2 relay outputs Note: Cannot be operated on an EASY7...-DA-R... |
| Special expansion units see current catalogue | | |

2.7.1 Local expansion module

Local expansion units are connected directly next to the basic unit.

- ▶ Connect the easy expansion unit via the EASY-LINK-DS bus connector plug.

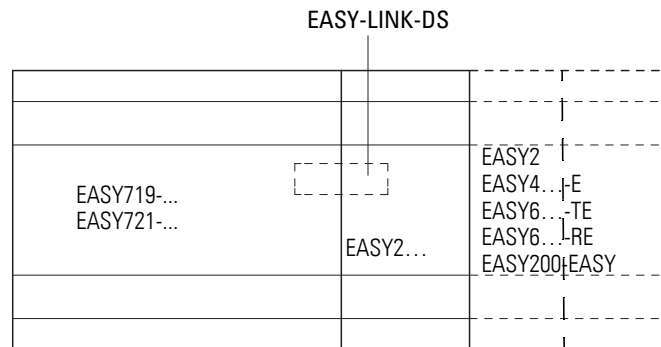

Figure 35: Connecting local expansion with basic device



DANGER

The following electrical separation is implemented between the EASY7.. basic unit and the expansion device (separation always in local connection of expansion unit):

- Basic isolation 400 V AC (+10 %)
- Safe isolation 240 V AC (+10 %)

Units may be destroyed if the value 400 V AC +10 % is exceeded, and may cause the malfunction of the entire system or machine!



Basic unit and expansion unit can be provided with different DC power supplies.

2 Installation

2.7 Expanding inputs/outputs .

2.7.2 Remote expansion

Remote expansion units can be installed and run up to 30 m away from the basic unit.



DANGER

The two-wire or multi-core cable between units must have the necessary insulation voltage required for the installation environment concerned. In the event of a fault (ground leakage, short-circuit) serious damage or injury to persons may otherwise occur.

A cable such as NYMO with a rated operating voltage of $U_e = 300/500$ V AC is normally sufficient.

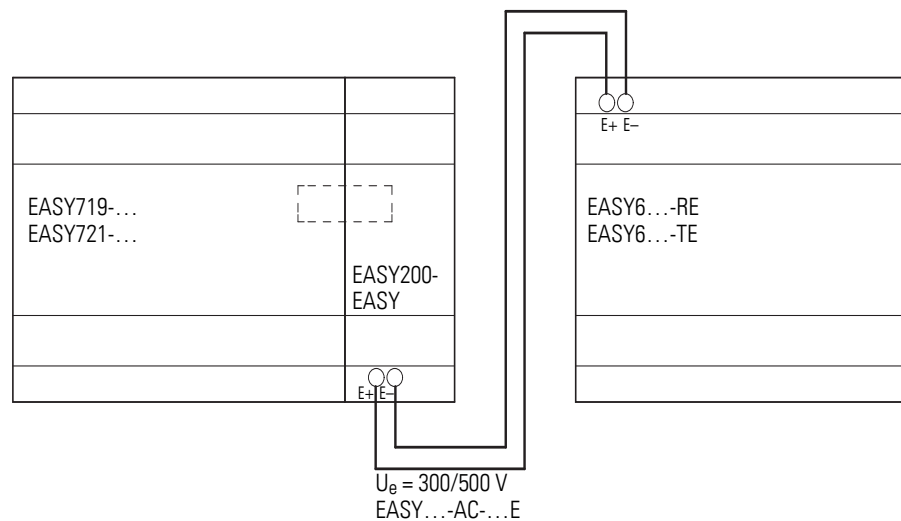

Figure 36: Connecting remote expansion units to easy



Terminals E+ and E- of the EASY200-EASY are protected against short-circuits and polarity reversal.

Functionality is only ensured if "E+" is connected with "E+" and "E-" with "E-".

2.8 Connecting bus systems

The easy-Link connection is designed in such a way that bus modules other than input/output expansions can also be connected. Special bus modules (gateways) are available for the relevant bus systems.

→ easy-Link allows the connection of one device (expansion unit or bus module).

At present easy700 can communicate via the following bus systems or networks:

- AS-Interface (Actuator-Sensor Interface)
- Profibus-DP
- CANopen
- DeviceNET
- Ethernet gateway.

The functionality of bus systems varies. The following generally applies:

- As a minimum data exchange, the input data R1 to R16 and output data S1 to S8 can be exchanged, provided that the bus system supports this.
- If the bus system or bus gateway is capable of this, function block, date, time parameters can be read and written via the bus. The states of inputs, outputs, markers can be read.

→ The range and the functions of the bus gateways are being continually further developed.
Our latest product range or Internet online catalogue contains the valid and available bus modules.

2 Installation

2.8 Connecting bus systems

3 Placing into operation

3.1 Switch-on

Before switching on easy, check that you have connected the power supply terminals and inputs correctly:

- 24 V AC version easy-AB
 - Terminal L: Phase conductor L
 - Terminal N: Neutral conductor N
 - Terminals I1 to I12:
Actuation via same phase conductor L
- 230 V AC version easy-AC
 - Terminal L: Phase conductor L
 - Terminal N: Neutral conductor N
 - Terminals I1 to I12, R1 to R12:
Actuation via phase conductor L
- 12 V DC version:
 - Terminal +12 V: voltage +12 V
 - Terminal 0 V: Voltage 0 V
 - Terminals I1 to I12:
Actuation via same +12 V
- 24 V DC version:
 - Terminal +24 V: Voltage +24 V
 - Terminal 0 V: Voltage 0 V
 - Terminals I1 to I12, R1 to R12:
Actuation via the same +24 V

If you have already integrated easy into a system, secure any parts of the system connected to the operating range to prevent access and ensure that no-one can be injured if, for example, motors start up unexpectedly.

3.2 Setting the menu language

When you switch on easy for the first time, you will be asked to select the menu language.

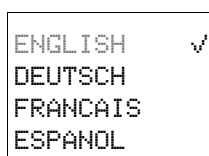

- ▶ Use the cursor buttons \wedge or \vee to select the language required.
 - English
 - Deutsch
 - French
 - Spanish
 - Italian
 - Portuguese
 - Dutch
 - Swedish
 - Polish
 - Turkish
 - Czech
 - Hungarian
- ▶ Press **OK** to confirm your choice and press **ESC** to exit the menu.

3 Placing into operation

3.3 easyoperating modes

The device will then switch to the status display.



You can change the language setting at a later time, (→ Section "5.2 Changing the menu language", page 167). If you do not set the language, easy will display this menu and wait for you to select a language every time you switch on.

3.3 easyoperating modes

easy has two operating modes - RUN and STOP.

In RUN mode easy continuously processes a stored circuit diagram until you select STOP or disconnect the power. The circuit diagram, parameters and the easy settings are retained in the event of a power failure. All you will have to do is reset the real-time clock after the back-up time has elapsed. Circuit diagram entry is only possible in STOP mode.



WARNING

In RUN mode easy will immediately run the saved circuit diagram in the unit when the power supply is switched on. This will happen unless STOP mode was set as startup mode. In RUN mode outputs are activated according to the switch logic of the circuit diagram.

When a memory card with a circuit diagram is fitted in an easy model with an LCD display, this circuit diagram will not start automatically if there is circuit diagram in the device. The circuit diagram must first be transferred from the memory card to the easy unit.

In RUN mode easy-X models load the circuit diagram on the memory card automatically and run it immediately.

3.4 Creating your first circuit diagram

The following small circuit diagram takes you step by step through wiring up your first easy circuit diagram. In this way you will learn all the rules, quickly enabling you to use easy for your own projects.

As with conventional wiring, you use contacts and relays in the easy circuit diagram. With easy, however, you no longer have to connect up components individually. At the push of a few buttons, the easy circuit diagram produces all the wiring. All you have to do is then connect any switches, sensors, lamps or contactors you wish to use.

3 Placing into operation

3.4 Creating your first circuit diagram

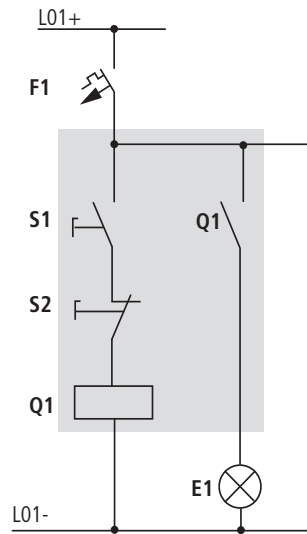

Figure 37: Lamp controller with relays

In the following example, easy carries out all the wiring and performs the tasks of the circuit diagram shown below.

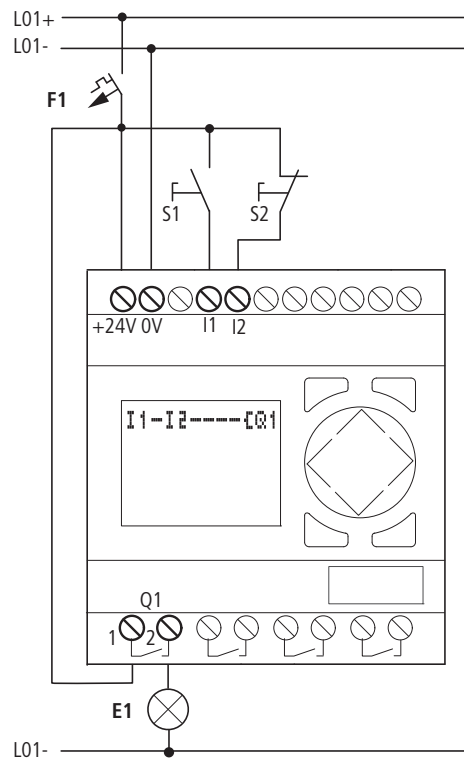
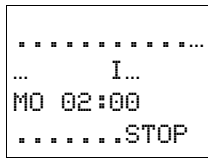

Figure 38: Lamp control using easy

3 Placing into operation

3.4 Creating your first circuit diagram

3.4.0.1 Starting point: Status display



```
.....  
... I...  
MO 02:00  
.....STOP
```

easy activates the status display after it is powered up. The status display indicates the switching state of the inputs and outputs and whether easy is already running a circuit diagram.



The examples were written without the use of expansion units. If an expansion unit is connected, the Status display will first show the status of the basic unit and then the status of the expansion unit before showing the first selection menu.

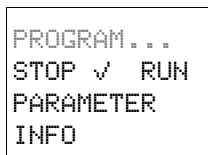

```
PROGRAM...  
STOP ✓ RUN  
PARAMETER  
INFO
```

- ▶ Press **OK** to switch to the main menu.

Press **OK** to switch to the next menu level, and press **ESC** to move one level back.



OK has two other functions:

- Press **OK** to save modified settings.
- In the circuit diagram, you can also press **OK** to insert and modify contacts and relay coils.

In this case easy must be in STOP mode.

- ▶ Press **OK** 2 x to enter the circuit diagram display via menu items PROGRAM... h PROGRAM. This is where you will create the circuit diagram.

3.4.1 Circuit diagram display

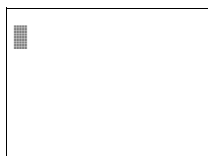

The circuit diagram display is currently empty. The cursor flashes at the top left, which is where you will start to wire your circuit diagram. easy will automatically propose the first contact I1.

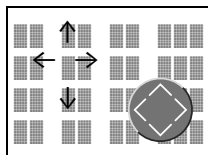

Use the $\wedge \vee \langle \rangle$ cursor buttons to move the cursor over the invisible circuit diagram grid.

The first three double columns are the contact fields and the right-hand columns form the coil field. Each line is a rung. easy automatically energizes the first contact to voltage.

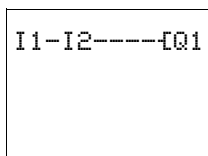

```
I1-I2-----[Q1
```

- ▶ Now try to wire up the following easy circuit diagram.

The switches I1 and I2 are at the input whilst I1 and I2 are the contacts for the input terminals. Relay K1 is represented by the relay coil \lrcorner Q1. The symbol \lrcorner identifies the coil's function, in this case a relay coil acting as a contactor. Q1 is one of up to eight easy output relays in the basic unit.

3.4.2 From the first contact to the output coil

With easy, you work from the input to the output. The first input contact is I1.

- ▶ Press **OK**.

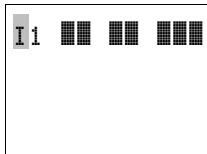

easy inserts the first contact I1 at the cursor position.

- ▶ The I flashes and can be changed, for example, to a P for a button input by using the cursor buttons ^ or v. However, nothing needs to be changed at this point.
- ▶ Press OK 2 x, to move the cursor across the 1 to the second contact field.

You could also move the cursor to the next contact field using the cursor button >.

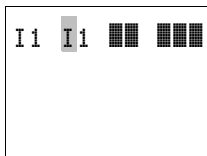

- ▶ Press **OK**.

Again, easy creates a contact I1 at the cursor position. Change the contact number to I2 so that N/C contact S2 can be connected to input terminal I2.

- ▶ Press **OK** so that the cursor jumps to the next position and use cursor buttons ^ or v to change the number 2.



Press **DEL** to delete a contact at the cursor position.

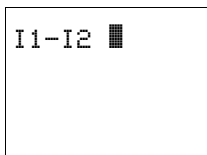

- ▶ Press **OK** to move the cursor to the third contact field.

You do not need a third relay contact, so you can now wire the contacts directly up to the coil field.

3.4.3 Wiring

easy displays a small wiring arrow in the circuit diagram for creating the wiring.

Press **ALT** to activate the arrow and press the cursor buttons ^ v < > to move it.



ALT also has two other functions depending on the cursor position:

- From the left contact field, press **ALT** to insert a new, empty rung.
- The contact under the cursor can be changed between a N/O and N/C contact by pressing the **ALT** button.

3 Placing into operation

3.4 Creating your first circuit diagram

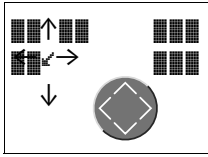

The wiring arrow works between contacts and relays. When you move the arrow onto a contact or relay coil, it changes back to the cursor and can be reactivated if required.



easy automatically wires adjacent contacts in a rung up to the coil.

- ▶ Press **ALT** to wire the cursor from I2 through to the coil field.

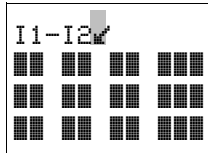

The cursor changes into a flashing wiring arrow and automatically jumps to the next logical wiring position.

- ▶ Press the cursor button >. Contact I2 will be connected up to the coil field.



You can use **DEL** to erase a connection at the cursor or arrow position. Where connections intersect, the vertical connections are deleted first, then, if you press **DEL** again, the horizontal connections are deleted.

- ▶ Press the cursor button > once more.

The cursor will move to the coil field.

- ▶ Press **OK**.

easy will insert relay coil Q1. The specified coil function \bar{I} and the output relay Q1 are correct and do not have to be changed.

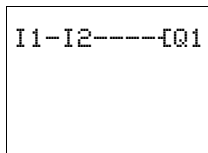
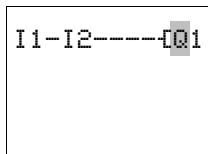

Your first working easy circuit diagram now looks like this:

Press **ESC** to leave the circuit diagram display.



The adjacent menu will appear.

- ▶ Press **OK**.

The circuit diagram is now automatically saved. CANCEL exits the circuit diagram. Changes that have been made to the circuit diagram are not saved.



easy saves all the necessary circuit diagram and program data retentively in the internal data memory.

Once you have connected pushbutton actuators S1 and S2, you can test your circuit diagram straight away.

3.4.4 Testing the circuit diagram

```
PROGRAM.. .↑
STOP ✓ RUN
PARAMETERS..
INFO... ↓
```

▶ Switch with **ESC** to the main menu and select the STOP ✓ RUN menu option.

With STOP RUN ✓ and STOP ✓ RUN you switch to the RUN or STOP operating modes.

easy is in RUN mode if the tick is present at the corresponding menu item. i.e. STOP RUN ✓.



The tick next to a menu item indicates which operating mode or function is currently active.

```
PROGRAM.. .↑
STOP RUN ✓
PARAMETERS..
INFO... ↓
```

▶ Press **OK**.

The tick changes to "STOP RUN ✓"

The Status display shows the current mode and the switching states of the inputs and outputs.

```
12.....
I
MO 02:00
1..... RUN
```

▶ Change to the Status display by pressing **ESC** and press pushbutton actuator S1.

The contacts for inputs I1 and I2 are activated and relay Q1 picks up.

3.4.4.1 Power Flow Display

easy allows you to check rungs in RUN mode. This means that you can check your circuit diagram via the built-in power flow display while it is being processed by easy.

```
I1-I2-----Q1
```

▶ Switch to the circuit diagram display (confirm PROGRAM menu with OK) and actuate pushbutton S1.

The relay picks up and easy displays the power flow.

```
I1-I2-----Q1
```

▶ Press pushbutton actuator S2, that has been connected as the N/C contact.

The power flow is interrupted and relay Q1 drops out.

Press **ESC** to return to the Status display.



A circuit diagram does not have to be completed before you can test parts of it with easy.

easy simply ignores any incomplete wiring that is not yet working and only uses the finished wiring.

3 Placing into operation

3.4 Creating your first circuit diagram

3.4.5 Deleting the circuit diagram

- ▶ Switch easy to STOP mode.

The display shows STOP ✓ RUN.



easy must be in STOP mode in order to extend, delete or modify the circuit diagram.



- ▶ Use PROGRAM... to switch from the main menu to the next menu level.
- ▶ Select DELETE PROG.

easy will display the prompt DELETE?.

- ▶ Press **OK** to delete the program or **ESC** to cancel.

Press **ESC** to return to the Status display.

3.4.6 Fast circuit diagram entry

You can create a circuit diagram in several ways: The first option is to enter the elements in the circuit and then to wire all the elements together. The other option is to use the enhanced operator guidance of easy and create the circuit diagram in one go, from the first contact through to the last coil.

If you use the first option, you will have to select some of the elements in order to create and connect up your circuit diagram.





The second, faster option is what you learned in the example. In this case you create the entire rung from left to right.

4 Wiring easy with

By working through the example in chapter 3 you should now have gained an initial impression of just how simple it is to create a circuit diagram in easy. This chapter describes the technical overview of easy functions and provides further examples of how to use easy.

4.1 easy-operation

4.1.1 Buttons for editing circuit diagrams and function relays

| | |
|---|--|
|  | Delete rung, contact, relay or empty rung in the circuit diagram |
|  | Toggle between N/C and N/O contact Connect contacts, relays and rungs Add rungs, |
|  | ^v Change value Move cursor up/down <> Change place Cursor left/right |
| | Cursor buttons set as P buttons: |
| | < Input P1, ^ Input P2 |
| | > Input P3, v Input P4 |
|  | Undo setting from last OK Leave current display, menu |
|  | Change, add new contact/relay, Save setting |

4.1.2 Operation

The cursor buttons in the easy circuit diagram perform three functions. The current mode is indicated by the appearance of the flashing cursor.

- Move
- Enter
- Connecting

 In Move mode, use ^v <> to position the cursor on the circuit diagram in order to select a rung, a contact or a relay coil.

 Use **OK** to switch to Entry mode so that you can enter or change a value at the current cursor position. If you press **ESC** in Entry mode, easy will undo the most recent changes.

 Press **ALT** to switch to Connect mode for wiring contacts and relays. Press **ALT** again to return to Move.

4 Wiring easy with

4.1 easy-operation

Press **ESC** to exit the circuit diagram and parameter display.



easy performs many of these cursor movements automatically. For example, easy switches the cursor to Move mode if no further entries or connections are possible at the selected cursor position.

4.1.2.1 Opening the parameter display for function relays with contacts or coils

If you specify the contact or coil of a function relay in Entry mode, easy automatically switches from the contact number to the function relay parameter display when you press **OK**.

Press **>** to switch to the next contact or coil field without entering any parameters.

4.1.2.2 Program

A program is a sequence of commands which easy executes cyclically in RUN mode. An easy program consists of the necessary settings for the device, password, system settings, a circuit diagram and/or function relays.

4.1.2.3 Circuit Diagram

The circuit diagram is that part of the program where the contacts are connected together. In RUN mode a coil is switched on and off in accordance with the current flow and the coil function specified.

4.1.2.4 Function Relays

Function relays are program elements with special functions. Example: timing relays, time switches, counters. Function relays are elements provided with or without contacts and coils as required. In RUN mode the function relays are processed according to the circuit diagram and the results are updated accordingly.

- Examples:
Timing relay = function relay with contacts and coils
Time switch = function relay with contacts

4.1.2.5 Relay

Relays are switching devices which are electronically simulated in easy. They actuate their contacts according to their designated function. A relay consists of at least one coil and contact.



4.1.2.6 Contacts

You modify the power flow with the contacts in the easy circuit diagram. Contacts such as N/O contacts are set to 1 when they are closed and 0 when they are opened. Every contact in the easy circuit diagram can be defined as either an N/O contact or an N/C contact.

4.1.2.7 Coils

Coils are the actuating mechanisms of relays. In RUN mode, the results of the wiring are sent to the coils, which switch on or off accordingly. Coils can have seven different coil functions.

Table 6: Usable contacts

| Contact | easy representation |
|--|--|
|  N/O contact, Open in the rest state | I, Q, M, N, A, B, Y, C, T, O, P, S, D, S, R, Z |
|  Break contact, Closed in the rest state | $\bar{I}, \bar{Q}, \bar{M}, \bar{N}, \bar{A}, \bar{B}, \bar{Y}, \bar{C}, \bar{T}, \bar{O}, \bar{P}, \bar{S}, \bar{D}, \bar{S}, \bar{R}, \bar{Z}$ |

Easy works with different contacts, which can be used in any order in the contact fields of the circuit diagram.



To ensure compatibility with easy400 and easy600 devices, each easy500 and easy700 is provided logically with all possible contacts. The switching state is always zero if contacts are not supported by the device, i.e.

- devices without a clock. The contacts (N/O contact) of the time switches are always set to logic 0.

The advantage of this process is that you can use the same circuit diagram on all easy500, easy700, easy-AB, easy-AC, easy-DA and easy-DC devices.

4 Wiring easy with

4.1 easy-operation

Table 7: Contacts

| Switching contact | N/O | N/C | easy500 | easy700 | Page |
|---|-----|-----------|---------------------|-----------|----------|
| Analog value comparator function relay | A | \bar{A} | A1...A16 | A1...A16 | 82 |
| Counter function relays | C | \bar{C} | C1...C16 | C1...C16 | 94 |
| Text marker function relay | D | \bar{D} | D1...D16 | D1...D16 | 109 |
| Week time switch function relay | Ø | $\bar{Ø}$ | Ø1...Ø8 | Ø1...Ø8 | 113 |
| easy input terminal | I | \bar{I} | I1...I8 | I1...I12 | 66 |
| 0 signal | | | I13 | I13 | |
| Expansion status | | | – | I14 | 194 |
| Short-Circuit/Overload | | | I16 | I15...I16 | 194 |
| Markers, (auxiliary relay) | | | M | \bar{M} | M1...M16 |
| Markers (auxiliary relay) | N | \bar{N} | N1...N16 | N1...N16 | 72 |
| Operating Hours Counter | O | \bar{O} | O1...O4 | O1...O4 | 118 |
| Cursor button | P | \bar{P} | P1...P4 | P1...P4 | 70 |
| easy output | Q | \bar{Q} | Q1...Q4 | Q1...Q8 | 66 |
| Input terminal for expansion unit | R | \bar{R} | – | R1...R12 | 66 |
| Short-circuit/overload with expansion | R | \bar{R} | – | R15...R16 | 194 |
| easy output (expansion or S auxiliary marker) | S | \bar{S} | S1...S8 (as marker) | S1...S8 | 72 |
| Timer function relays | T | \bar{T} | T1...T16 | T1...T16 | 122 |
| Jump label | : | – | :1...:8 | :1...:8 | 135 |
| Year Time Switch | Y | \bar{Y} | Y1...Y8 | Y1...Y8 | 137 |
| Master reset, (central reset) | Z | \bar{Z} | Z1...Z3 | Z1...Z3 | 147 |

4.1.3 Relays, function relays

easy has nine different types of relay for wiring in a circuit diagram.



In order to ensure compatibility with the easy400 and easy600 devices, each easy500 and easy700 logically supports all relay types internally. If a relay type is not supported by the device, the switching state of the contacts is always set to zero, i.e.

- devices without a clock. The contacts (N/O contact) of the time switches are always set to logic 0.

The advantage of this process is that you can use the same circuit diagram on all easy500, easy700, easy-AB, easy-AC, easy-DA and easy-DC devices. Furthermore, you can use outputs that are not physically present as markers.

| Relay | easy display | easy500 | easy700 | Coil function | Parameters |
|--|--------------|------------------------|-----------|---------------|------------|
| Analog value comparator function relay | A | A1...A16 | A1...A16 | – | ✓ |
| Counter function relays | C | C1...C16 | C1...C16 | ✓ | ✓ |
| Text marker function relay | D | D1...D16 | D1...D16 | ✓ | ✓ |
| Week time switch function relay | Ø | Ø11...Ø14 | Ø11...Ø14 | – | ✓ |
| Markers (auxiliary relay) | M | M1...M16 | M1...M16 | ✓ | – |
| Markers (auxiliary relay) | N | N1...N16 | N1...N16 | ✓ | – |
| Operating Hours Counter | O | O1...O4 | O1...O4 | ✓ | ✓ |
| easy output relays | Q | Q1...Q8 | Q1...Q8 | ✓ | – |
| easy output relay expansion, auxiliary markers | S | S1...S8 (as marker) | S1...S8 | ✓ | – |
| Timer function relays | T | T1...T16 | T1...T16 | ✓ | ✓ |
| Conditional Jump | : | :1...:8 | :1...:8 | ✓ | – |
| Year Time Switch | Y | Y1...Y8 | Y1...Y8 | – | ✓ |
| Master reset, (central reset) | Z | Z1...Z3 | Z1...Z3 | ✓ | – |

You can set the switching behavior of these relays by means of the coil functions and parameters selected.

The options for setting output and marker relays are listed with the description of each coil function.

The coil functions and parameters are listed with the description of each function relay.

4 Wiring easy with

4.1 easy-operation

4.1.3.1 Circuit diagram display

In the easy circuit diagram, contacts and coils are connected up from left to right - from the contact to the coil. The circuit diagram is created on a hidden wiring grid containing contact fields, coil fields and rungs. It is then wired up with connections.

- You can add switch contacts in the three **contact fields**. The first contact field is automatically connected to the voltage.
- You add the relay coil to be controlled together with its function and designation in the **coil field**.
- Each line in the circuit diagram represents a **rung**. Up to 128 rungs can be wired in a circuit diagram.

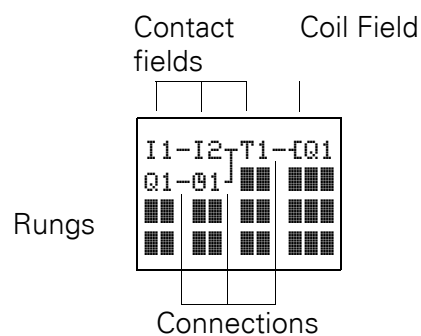

Connections are used to produce the electrical contact between switch contacts and the coils. They can be created across several rungs. Each point of intersection is a connection.



The circuit diagram display performs two functions:

- In STOP mode it is used to edit the circuit diagram.
- In RUN mode it is used to check the circuit diagram using the Power flow display.

4.1.4 Saving and loading circuit diagrams

There are two ways of saving circuit diagrams in easy externally:

- Saving to a memory card
- Saving on a PC with the easySoft programming software.

Once they have been saved, programs can be reloaded into easy, edited and run.

All circuit diagram data is saved in easy. In the event of a power failure the data will be retained until the next time it is overwritten or deleted.

4.1.4.1 Memory card

Each EASY-M-32K memory card contains a circuit diagram which is inserted into the easy interface. The program is stored retentively on the memory card.

The way the memory card works and a description of how to transfer a program to the card, (→ Section "6.7 Memory card", page 197)



EASY-M-8K memory cards of easy400 devices can be read in easy500. Memory cards of easy400 EASY-M-8K and easy600 EASY-M16K devices can be read in easy700.

Write operations from easy500 and easy700 are only possible to the EASY-M32K memory card.

4.1.4.2 easySoft

easySoft-Basic and easySoft-Pro are PC programs for creating, testing and managing easy circuit diagrams.

Completed circuit diagrams are transferred between your PC and easy via the connecting cable. Once you have transferred a circuit diagram, simply run easy straight from your PC.

Details on the program and transferring circuit diagrams, (→ Section "6.8 easySoft", page 200).

4 Wiring easy with

4.2 Working with contacts and relays

4.2 Working with contacts and relays

In easy circuit diagrams, the switches, buttons and relays of conventional circuit diagrams are connected up using input contacts and relay coils.

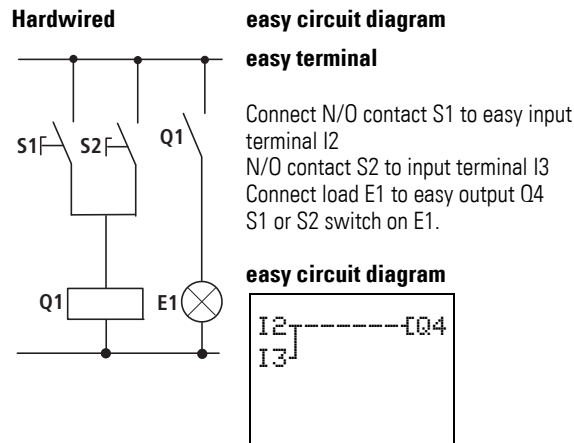

4.2.1 Input and output contacts

First specify which input and output terminals you wish to use in your circuit.

Depending on the type and configuration, easy has 8, 12 or 24 input terminals and 4, 6, 8, 10 or 16 outputs. The signal states at the input terminals are evaluated in the circuit diagram with the input contacts I1 to I12. R1 to R12 are input contacts of the expansion. The outputs are connected in the circuit diagram with the output relays Q1 to Q8 or S1 to S8 (expansion).

4.2.1.1 Entering and changing contacts and relay coils

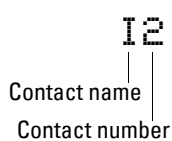

A switch contact is selected in easy via the contact name and contact number.

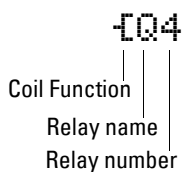

A relay coil is defined by its coil function, name and number.



A full list of all the contacts and relays is given in the overview starting on page 61.

I1

Values for contacts and coil fields are changed in Entry mode. The value to be changed flashes.



If the field is empty, easy will enter contact $\bar{I}1$ or the coil $\bar{Q}1$.

- ▶ Move the cursor using the buttons < > ^ v to a contact or coil field.
- ▶ Press **OK** to switch to Entry mode.

- ▶ Use < > to select the position you wish to change, or press **OK** to jump to the next position.
- ▶ Use ^ v to modify the value of the position.

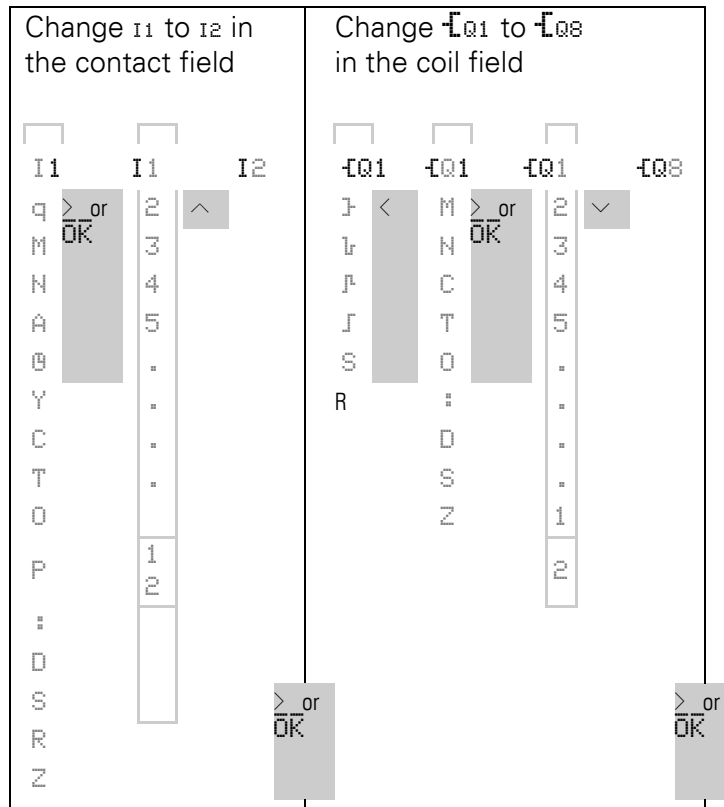

easy will leave Entry mode when you press < > or **OK** to leave a contact field or coil field.

4.2.1.2 Deleting contacts and relay coils

- ▶ Move the cursor using the buttons < > ^ v to a contact or coil field.
- ▶ Press **DEL**.

The contact or the relay coil will be deleted, together with any connections.

4 Wiring easy with

4.2 Working with contacts and relays

4.2.1.3 Changing N/O contacts to N/C contacts

Every switch contact in the easy circuit diagram can be defined as either the N/O contact or the N/C contact.

- ▶ Switch to Entry mode and move the cursor over the contact name.
- ▶ Press **ALT**. The N/O contact will change to a N/C contact.
- ▶ Press **OK** twice to confirm the change.

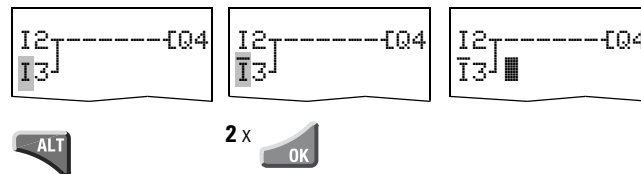

Figure 39: Changing contact I3 from N/O to N/C

4.2.2 Creating and modifying connections

You connect switch contacts and relay coils with the wiring arrow in Connect mode. In this mode easy displays the cursor as an arrow.

- ▶ Use <> ^∨ to move the cursor to the contact or coil field from which you wish to create a connection.



Do not position the cursor on the first contact field. At this position the **ALT** button has a different function (Insert rung).

- ▶ Press **ALT** to switch to Connect mode.
- ▶ Use <> to move the diagonal arrow between the contact fields and coil fields and ^∨ to move between circuit connections.
- ▶ Press **ALT** to leave Connect mode.

easy will leave the mode automatically when you move the diagonal arrow onto a contact field or coil field which has already been assigned.



In a rung, easy automatically connects switch contacts and the connection to the relay coil if there are no empty fields in-between.

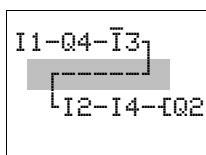

Never work backwards, (→ section "6.1.1.2 Example: Do not wire backwards", page 188).

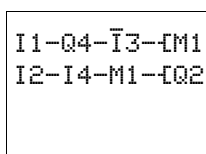

When wiring more than three contacts in series, use an M or N marker.

4.2.2.1 Deleting Connections

- ▶ Move the cursor onto the contact field or coil field to the right of the connection that you want to delete. Press **ALT** to switch to Connect mode.
- ▶ Press **DEL**.

easy will delete a connection. Closed adjacent connections will be retained.

If several rungs are connected to one another, easy first deletes the vertical connection. If you press **DEL** again, it will delete the horizontal connection as well.



You cannot delete connections that easy has created automatically.

Close the delete operation with **ALT** or by moving the cursor to a contact or coil field.

4.2.3 Inserting and deleting a rung

The easy circuit diagram shows four of the 128 rungs in the display at the same time. If you move the cursor past the top or bottom of the display, easy automatically scrolls up or down the display to show hidden rungs – even empty ones.

A new rung is added below the last connection. or inserted above the cursor position:

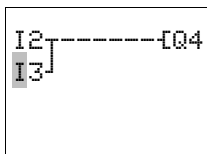

- ▶ Position the cursor on the **first** contact field of a circuit connection.
- ▶ Press **ALT**.

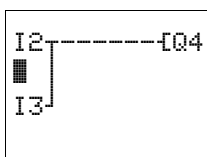

The existing rung with all its additional connections is “shifted” downwards. The cursor is then positioned directly in the new rung.

4.2.3.1 Delete Rung

easy will only remove empty rungs, i.e. those without contacts or coils.

- ▶ Delete all the contacts and relay coils from the rung.
- ▶ Position the cursor on the first contact field of the empty rung.
- ▶ Press **DEL**.

The subsequent rung(s) will be “pulled up” and any existing links between rungs will be retained.

4 Wiring easy with

4.2 Working with contacts and relays

4.2.4 Switching with the Cursor Buttons

With easy, you can also use the four cursor buttons as hard-wired inputs in the circuit diagram.

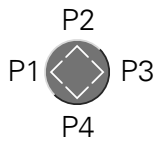

The buttons are wired in the circuit diagram as contacts P1 to P4. The P buttons can be activated and deactivated in the System menu.

The P buttons can also be used for testing circuits or manual operation. The button function is a useful addition for service and commissioning tasks.

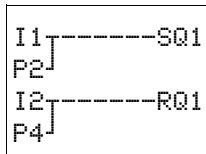

Example 1:

A lamp at output relay Q1 is switched on and off via inputs I1 and I2 or using cursor buttons \wedge \vee .

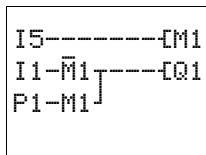

Example 2:

Terminal I1 is used to control output relay Q1. Terminal I5 switches to Cursor button mode and deactivates rung I1 via $\overline{M1}$.



The P buttons are only detected as switches in the Status menu. The cursor buttons are used for other functions in the menus, the power flow display and in the text display.

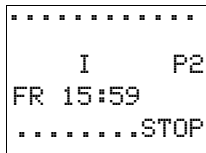

The Status menu display shows whether the P buttons are used in the circuit diagram.

- P: button function wired and active.
- P2: button function wired, active and P2 button \wedge pressed
- P-: button function wired and not active.
- Empty field: P buttons not used.

4.2.5 Checking the circuit diagram

easy contains a built-in measuring device enabling you to monitor the switching states of contacts and relay coils during operation.

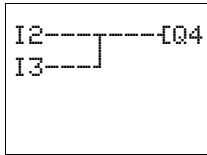

- ▶ Complete the small parallel connection and switch easy to RUN mode via the main menu.
- ▶ Return to the circuit diagram display.

You are now unable to edit the circuit diagram.



If you switch to the circuit diagram display and are unable to modify a circuit diagram, first check whether easy is in STOP mode.

The circuit diagram display performs two functions depending on the mode:

- STOP: Creation of the circuit diagram
- RUN: Power flow display

- ▶ Switch on I3.

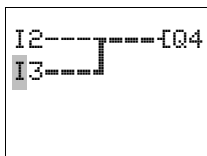

In the power flow display, energized connections are thicker than non-energized connections.

You can follow energized connections across all rungs by scrolling the display up and down.



The power flow display will not show signal fluctuations in the millisecond range. This is due to the inherent delay factor of LCD displays.

4 Wiring easy with

4.2 Working with contacts and relays

4.2.6 Coil Functions

You can set the coil function to determine the switching behavior of relay coils. The following coil functions are available for relays Q, M, S, D, “:”:

Table 8: Coil Function

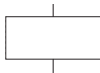
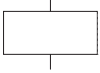
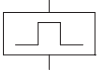
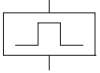
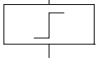
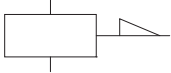
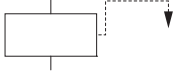
| Circuit diagram display | easy display | Coil function | Example |
|---|--------------|--|------------------------|
|  | Q | Contactor Function | Q01, Q02, S04, I:1, M7 |
|  | Q̄ | Contactor function with negated result | Q01, Q02, S04 |
|  | Qr | Cycle pulse on falling edge | Q03, M4, Q8, S7 |
|  | Q↑ | Cycle pulse on rising edge | Q04, M5, Q7, S3 |
|  | Q̄r | Surge function | Q03, M4, Q8, S7 |
|  | S | Latch (set) | S08, S02, S03, S04 |
|  | R | Reset (unlatching) | R04, R05, R07, R03 |

Marker relays M and N are used as a flag. The S relay can be used as the output of an expansion unit or as a marker if no expansion unit is connected. The only difference between them and the output relay Q is that they have no output terminals.



The coil functions of the function relays are described in the descriptions for the appropriate relays.



The coil functions Q, Q̄, Qr, Q↑, (contactor, contactor negated, cycle pulse negative, rising edge) must only be used once for each relay coil. The last coil in the circuit diagram determines the status of the relay.

When controlling a contactor or relay, the control coil is only present once. If you are creating parallel circuits, use Set, Reset as a coil function.

4.2.6.1 Rules for wiring relay coils

To ensure a clear overview of all relay states only assign the same coil function once to a relay (I , $\bar{\text{S}}$, $\bar{\text{R}}$). However, retentive coil functions such as I , $\bar{\text{S}}$, $\bar{\text{R}}$ can be used several times if required by the circuit diagram logic.

Exception: When using jumps to structure a circuit diagram, this coil function can also be used effectively several times.

4.2.6.2 Relay with contactor function C



The output signal follows the input signal directly, the relay operates as a contactor.

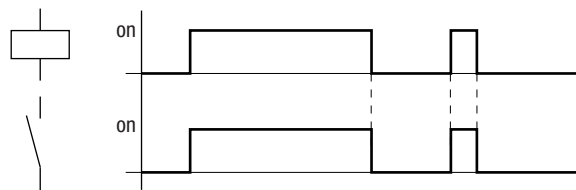

Figure 40: Signal diagram, contactor function

Representation in easy:

- Output relays Q: $\text{I}01$ to $\text{I}08$ (depending on type)
- Markers M, N: $\text{I}M1$ to $\text{I}M16$, $\text{I}N1$ to $\text{I}N16$
- Function relays (Text) D: $\text{I}D1$ to $\text{I}D16$
- Output relays S: $\text{I}S1$ to $\text{I}S8$
- Jumps: $\text{I}1$ to $\text{I}8$

4 Wiring easy with

4.2 Working with contacts and relays

4.2.6.3 Contactor function with negated result (inverse contactor function) \overline{I}



The output signal is simply an inversion of the input signal; the relay operates like a contactor with contacts that have been negated. If the coil is triggered with the state 1, the coil switches its N/O contacts to the state 0.

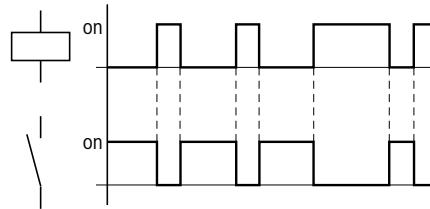

Figure 41: Signal diagram, inverted contactor function

Representation in easy:

- Output relays O: $\overline{O}01$ to $\overline{O}08$ (depending on type)
- Markers M, N: $\overline{M}1$ to $\overline{M}16$, $\overline{N}1$ to $\overline{N}16$
- Function relays (Text) D: $\overline{D}1$ to $\overline{D}16$
- Output relays S: $\overline{S}1$ to $\overline{S}8$
- Jumps: $\overline{J}1$ to $\overline{J}8$

4.2.6.4 Falling edge evaluation (cycle pulse) \overline{I}



This function is used if the coil is only meant to switch on a falling edge. With a drop-out in the coil state from 1 to 0, the coil switches its N/O contacts to the 1 state for one cycle.

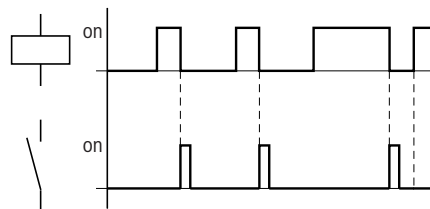

Figure 42: Signal diagram, cycle pulse on falling edge

Representation in easy:

- Markers M, N: $\overline{M}1$ to $\overline{M}16$, $\overline{N}1$ to $\overline{N}16$
- Jumps: $\overline{J}1$ to $\overline{J}8$



Physical outputs should not be used as a cycle pulse is generated.

4.2.6.5 Rising edge evaluation (cycle pulse) \overline{P}



This function is used if the coil is only meant to switch on a rising edge. With a change in the coil state from 0 to 1, the coil switches its N/O contacts to the 1 state for one cycle time.

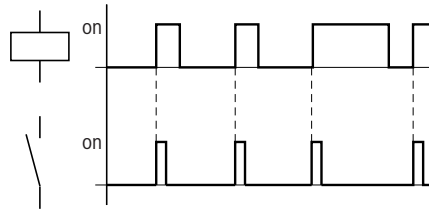

Figure 43: Signal diagram, cycle pulse on rising edge

Representation in easy:

- Markers M, N: $\overline{M1}$ $\overline{M16}$, $\overline{N1}$ to $\overline{N16}$
- Jumps: $\overline{J:1}$ to $\overline{J:8}$



Physical outputs should not be used as a cycle pulse is generated.

4.2.6.6 Impulse relay \overline{J}



The relay coil switches whenever the input signal changes from 0 to 1. The relay behaves like an impulse relay.

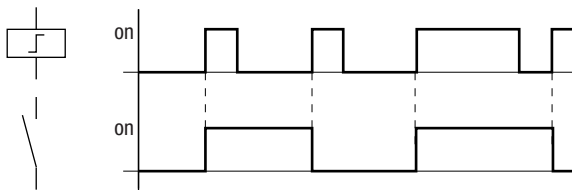

Figure 44: Signal diagram, impulse relay

Representation in easy:

- Output relay Q: $\overline{Q1}$ to $\overline{Q8}$ (depending on type)
- Markers M: $\overline{M1}$ to $\overline{M16}$
- Function relays (Text) D: $\overline{D1}$ to $\overline{D8}$
- Relays S: $\overline{S1}$ to $\overline{S8}$



A coil is automatically switched off in the event of a power failure and in STOP mode. Exception: Retentive coils retain signal 1 (→ Section "5.9 Retention (non-volatile data storage)", page 181).

4 Wiring easy with

4.2 Working with contacts and relays

4.2.6.7 Latching relay

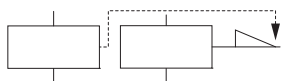

The “latch” and “unlatch” relay functions are used in pairs. The relay picks up when latched and remains in this state until it is reset by the “unlatch” function.

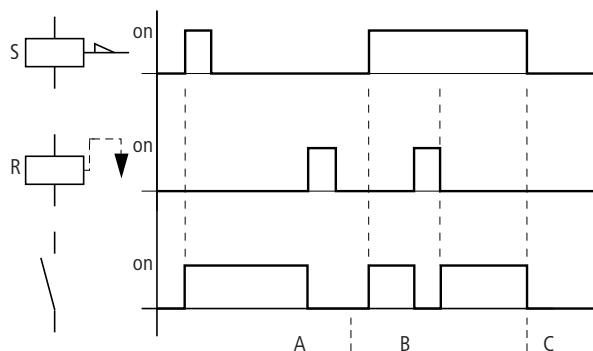

Figure 45: Latching relay signal diagram

- Range A: The Set coil and the Reset coil are triggered at different times
- Range B: Reset coil is triggered at the same time as the Set coil
- Range C: Power supply switched off

Representation in easy:

- Q output relays: SQ1 to SQ8, RQ1 to RQ8 (depending on type)
- M markers: SM1 to SM16, RM1 to RM16
- (Text) D function relays: SD1 to SD8, RD1 to RD8
- Relays S: SS1 to SS8, RS1 to RS8

Use each of the two relay functions S and R once only per relay.

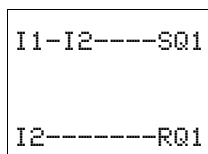

If both coils are triggered at the same time, priority is given to the coil further down in the circuit diagram. This is shown in the above signal diagram in section B.



A latched relay is automatically switched off if the power fails or if the device is in STOP mode. Exception: Retentive coils retain signal 1 (→ Section “5.9 Retention (non-volatile data storage)”, page 181).

4.3 Function Relays

Function relays allow you to simulate the functions of different conventional control engineering devices in your circuit diagram. easy provides the following function relays:

Table 9: Function Relays

| easy circuit diagram symbol | Function Relays |
|------------------------------|--|
| A1, A2 | Analog value comparator, threshold value switch (only useful for devices with an analog input) |
| C1, CC1, DC1, RC1 | Counter relay, up/down counter, high-speed counter, frequency counter |
| D2, tD2 | Text, output user-defined texts, enter values |
| Ø1, Ø2 | Time switch, weekday/time |
| O1, tO2 | Operating hours counter with limit value entry |
| T1, TT1, RT1, HT1 X, ?X | Timing relay, on-delayed Timing relay, on-delayed with random switching |
| T1, TT1, RT1, HT1 ■, ?■ | Timing relay, off-delayed Timing relay, off-delayed with random switching |
| T6, TT6, RT6, HT6 X■, ?X■ | Timing relay, on/off-delayed Timing relay, on/off delayed with random switching |
| T2, TT2, RT2, HT2 Л | Timing relay, single pulse |
| T3, TT3, RT3, HT3 ll | Timing relay, flashing |
| :=2, t:=2 | Jump |
| Y3 | Year time switch, date |
| Z1, Z3 | Master reset, central reset of outputs, markers |

A function relay is started via its relay coil or by evaluating a parameter. It switches the contact of the function relay according to its function and the set parameters.



Current actual values are cleared if the power supply is switched off or if easy is switched to STOP mode. Exception: Retentive coils keep their logic state (→ Section "5.9 Retention (non-volatile data storage)", page 181).

CAUTION

The following applies to RUN mode: easy processes the function relays after a pass through the circuit diagram. The last state of the coils is used for this. This takes the last status of the coils into account. Only use the coil of a function relay once. Exception: When working with jumps, the same coil can be used several times.

4.3.1 Example: with function relay timer and counter relay

A warning light flashes when the counter reaches 10. The example shows function relays C1 and T1. The S1 pushbutton actuator is used for the count signal. The S2 pushbutton actuator resets counter P1.

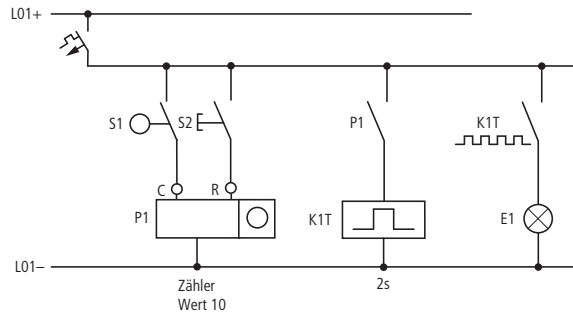

Figure 46: Hardwiring with relays

The wiring of the easy relay looks as follows.

| | | |
|----|-------|-----|
| I5 | ----- | CC1 |
| I6 | ----- | RC1 |
| C1 | ----- | TT1 |
| T1 | ----- | Q1 |

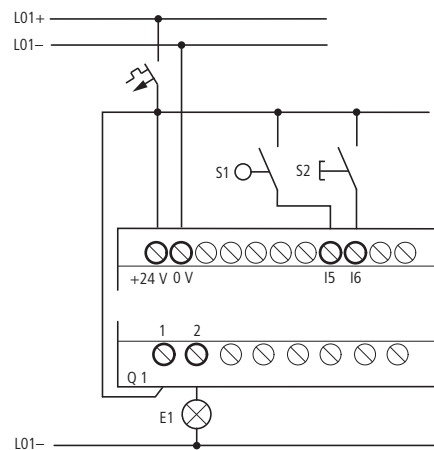

Figure 47: easy wiring and circuit diagram

The counter P1 is called C1 in easy.

The timing relay K1T is called T1 in easy.

► Complete the circuit diagram up to **CC1**.

CC1 is the count coil of the counter 1 function relay.

| | | |
|----|-------|-----|
| I5 | ----- | CC1 |
| | | |



Press **OK** to call up the easy parameter display.

► Move the cursor onto the **1** of **CC1** and press **OK**.

The parameter set for the counter is displayed.

```
C1 N      +
S   +0
```

- ▶ Press the cursor button until the cursor is on the plus sign on the right of the S (setpoint value).
- ▶ Press the **OK** button.

```
C1 N      +
S   00000
```

- ▶ Press the > button.

```
C1 N      +
S   00010
```

- ▶ Use > to move the cursor onto the tens digit.

```
C1 N      +
S   00010
```

- ▶ Use ^ v to modify the value of the digit.
- ▶ Confirm the value input with **OK**.

```
I5-----CC1
^
```

- ▶ Press **ESC** to return to the circuit diagram, the setpoint 0010 will be stored.



easy has specific parameter displays for function relays. The meaning of these parameters is explained under each relay type.

```
I5-----CC1
I6-----RC1
C1-----TT1
```

- ▶ Enter the circuit diagram up to coil **TT1** of the timing relay. Set the parameter for **T1**.

```
T1 X      S  +
I1   +0
I2   +0
T:
```

- The timing relay operates as a flash relay. The easy symbol for the flasher/blink relay is **⏏**. It is set at the top left of the parameter display. **S** means here the time base second.

```
T1 ⏏      S  +
I1   +0
I2   +0
T:
```

- ▶ Select the **⏏** symbol by pressing the v button.

```
T1 ⏏      S  +
I1   +0
I2   +0
T:
```

- ▶ Use the > to move to the first time setpoint **I1**.

4 Wiring easy with

4.3 Function Relays

```
T1 U S +
I1 00.000
I2 +0
T:
```

- ▶ Press the **OK** button.
- ▶ Press the > button.

```
T1 U S +
I1 01.000
I2 +0
T:
```

- ▶ Use the ^ v < > buttons to enter the value 001.0000.
- ▶ Confirm with **OK**.

The time setpoint **I1** for the pause time is 1 s

```
T1 U S +
I1 01.000
I2 00.50
T:
```

- ▶ Use the v button to enter the value of the second setpoint value I2.
- ▶ Set this value to 0.5 s.

This is the time value for the pulse time.

- ▶ Press **ESC** to leave the parameter entry.

The values are now stored.

```
I5-----CC1
I6-----RC1
C1-----TT1
T1-----Q1
```

- ▶ Complete the circuit diagram.

```
SAVE
CANCEL
```

- ▶ Press the **ESC** button.
- ▶ Press **OK** to store the circuit diagram.
- ▶ Test the circuit diagram with the power flow display.
- ▶ Switch easy to RUN mode and return to the circuit diagram.

Each parameter set can be displayed using the power flow display for the circuit diagram.

- ▶ Move the cursor onto **C1** and press **OK**.

```
C1 N +
S 0010
C:0000
```

The parameter set for the counter is displayed with actual and setpoint values.

- ▶ Switch I5. The actual value changes.

```
C1 N +
S 0010
C:0007
```

This is represented in the easy parameter display. In the last line **C: 0007** the counter actual value is = 7.

```
C1 N +
S 0010
■ C:0010
```

If the actual value is greater than or equal to the setpoint (10), the left character on the bottom row will change to ■. The contact of counter **C1** switches.

The counter contact triggers the timing relay. This causes the warning light to flash at output Q1.

```
I5-----CC1
I6-----RC1
C1=====TT1
T1=====O1
```

Power flow of the circuit diagram

```
T1  II   S  +
S1  00.50
S2  00.25
■ T:00.200
```

Doubling the flashing frequency:

- ▶ In the power flow display select **T1**.
- ▶ Press **OK**.
- ▶ Change the set time **I1** to **00.500** and **I2** to **00.250** (0.5 and 0.25 s).
- ▶ The set time will be accepted as soon as you press **OK**.

The character on the left of the bottom row will indicate whether the contact has switched or not.

- □ Contact has not switched (N/O contact open).
- ■ Contact has switched (N/O contact closed).

You can also modify parameter settings via the PARAMETER menu option.



If you want to prevent other people from modifying the parameters, change the access enable symbol from + to – when creating the circuit diagram and setting parameters. You can then protect the circuit diagram with a password.

4 Wiring easy with

4.4 Analog value comparator/threshold value switch

4.4 Analog value comparator/threshold value switch

easy provides 16 analog comparators A1 to A16 for use as required. These can also be used as threshold value switches or comparators.

| A1...A16 analog value comparator | | | |
|----------------------------------|---|-------------|---|
| Boolean inputs/outputs | | Parameters | |
| Contact | Coil | Input value | Output value |
| A.. | 1 if the selected actual value/setpoint condition is fulfilled. | | |
| | | I1 | Comparison value 1 |
| | | F1 | Gain factor for I1 ($I1 = F1 * \text{value}$) |
| | | I2 | Comparison value 2 |
| | | F2 | Gain factor for I2 ($I2 = F2 * \text{value}$) |
| | | OS | Offset for the value at I1, $I1_{OS} = OS + \text{actual value at I1}$ |
| | | HY | Switch hysteresis for value at I2 (value HY is used for both positive and negative hysteresis.) |

An analog value comparator or threshold value switch enables you to compare analog input values with a setpoint, the actual value of another function relay or another analog input. This enables you to implement small controller tasks such as two-point controllers very easily.

All easy-AB, easy-DA and easy-DC devices are provided with analog inputs.

- The analog inputs of the easy500 are I7 and I8.
- The analog inputs of the easy700 are I7, I8, I11 and I12



Compatibility with easy400 and easy600

If you are loading an existing easy400 or easy600 circuit diagram, the existing comparison functions and values are retained. The analog value comparison function relay works in easy500 and easy700 and in easy400, easy600. The setpoints are converted to the new resolution of the analog inputs. The setpoint 5.0 (easy400, easy600) is converted to the setpoint 512 (easy500, easy700).

The following comparisons are possible:

Table 10: Comparison table

| Value at function relay value input I1 | Comparator functions | Mode selection at the function relay | Value at function relay value input I2 |
|---|--|--------------------------------------|---|
| | | | |
| Analog input I7, I8, I11, I12 | Less than Less than/equal to Equal to Greater than/equal to Greater than | LT | Analog input I7, I8, I11, I12 |
| Setpoint 0000 to 9999 | | LE | Setpoint 0000 to 9999 |
| Actual value of counter relay C1 to C16 | | EQ | Actual value of counter relay C1 to C16 |
| Actual value of timing relay T1 to T16 | | GE GT | Actual value of timing relay T1 to T16 |

Table 11: Comparison examples:

| A1 function relay Value input I1 | Comparator functions | A1 function relay Value input I2 |
|----------------------------------|----------------------------|----------------------------------|
| I7 | GE (greater than/equal to) | I8 |
| I7 | LE (less than/equal to) | I8 |
| I7 | GE (greater than/equal to) | Setpoint |
| I7 | LE (less than/equal to) | Setpoint |
| I8 | GE (greater than/equal to) | Setpoint |
| I8 | LE (less than/equal to) | Setpoint |

4 Wiring easy with

4.4 Analog value comparator/threshold value switch

4.4.1 Circuit diagram display with analog value comparator

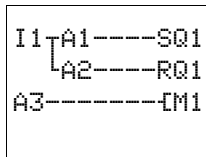

Analog value comparators are integrated as contacts in the circuit diagram.

In the circuit diagram above, I1 enables both analog value comparators. If a value goes below the set value, A1 switches output Q1. If another value exceeds the set value, A2 deactivates output Q1. A3 switches marker M1 on and off.

| | | |
|----|----|---|
| A1 | EQ | + |
| I1 | +0 | ↑ |
| F1 | +0 | |
| I2 | +0 | ↓ |
| F2 | +0 | |
| OS | +0 | |
| HY | +0 | |

Table 12: Parameter display and parameter set for analog value comparator:

| | |
|----|--|
| A1 | Analog value comparator function relay 1 |
| EQ | Equal mode The function relay has the following modes: <ul style="list-style-type: none"> • LT: less than • LE: less than/equal to • EQ: equal to • GE: greater than/equal to • GT: greater than |
| + | + appears in the PARAMETER menu. - does not appear in the PARAMETER menu |
| I1 | Comparison value 1 (positive value I7, I8, I11, I12, actual value T1 to T16, C1 to C16) |
| F1 | Gain factor for I1 (I1 = F1 x actual value at I1); F1 = positive value from 0 to 9999 |
| I2 | Comparison value 2 (positive value I7, I8, I11, I12, actual value T1 to T16, C1 to C16) |
| F2 | Gain factor for I2 (I2 = F2 x actual value at I2); F2 = positive value from 0 to 9999 |
| OS | Offset for the value of I1 (I1 = OS + actual value at I1); OS = positive value from 0 to 9999 |
| HY | Switching hysteresis for value I2 Value HY applies both to positive and negative hysteresis. <ul style="list-style-type: none"> • I2 = Actual value at I2 + HY; • I2 = Actual value at I2 - HY; • HY = positive value from 0 to 9999 |



Work normally with analog inputs and setpoints as the parameters for the analog value comparator.

4.4.2 Compatibility with easy400 with easy500 and easy600 with easy700

New functions have been added to the parameter display of easy500 and easy700. The easy400 and easy600 parameters can be found at the following points.

| | | | | | | | | | | | | | | | | | | | | | | | | | |
|----|----------------------------|----|----------------------------|---|----|----|---|----|----|---|----|----|--|----|----|---|----|----|--|----|----|--|----|----|--|
| | easy400/600- Parameters | = | easy500/700- Parameters | <table border="1"> <tr><td>A1</td><td>GE</td><td>+</td></tr> <tr><td>I1</td><td>AA</td><td>↑</td></tr> <tr><td>F1</td><td>+0</td><td></td></tr> <tr><td>I2</td><td>BB</td><td>↓</td></tr> <tr><td>F2</td><td>+0</td><td></td></tr> <tr><td>OS</td><td>+0</td><td></td></tr> <tr><td>HY</td><td>+0</td><td></td></tr> </table> | A1 | GE | + | I1 | AA | ↑ | F1 | +0 | | I2 | BB | ↓ | F2 | +0 | | OS | +0 | | HY | +0 | |
| | A1 | GE | + | | | | | | | | | | | | | | | | | | | | | | |
| I1 | AA | ↑ | | | | | | | | | | | | | | | | | | | | | | | |
| F1 | +0 | | | | | | | | | | | | | | | | | | | | | | | | |
| I2 | BB | ↓ | | | | | | | | | | | | | | | | | | | | | | | |
| F2 | +0 | | | | | | | | | | | | | | | | | | | | | | | | |
| OS | +0 | | | | | | | | | | | | | | | | | | | | | | | | |
| HY | +0 | | | | | | | | | | | | | | | | | | | | | | | | |
| AA | = | I1 | AA | | | | | | | | | | | | | | | | | | | | | | |
| BB | = | I2 | BB | | | | | | | | | | | | | | | | | | | | | | |
| A1 | = | A1 | | | | | | | | | | | | | | | | | | | | | | | |
| + | = | + | | | | | | | | | | | | | | | | | | | | | | | |
| ≥ | = | GE | | | | | | | | | | | | | | | | | | | | | | | |

- The analog value comparator for easy500 and easy700 operates internally in the value range:
-2147483648 to +2147483647
This ensures that the correct value is always calculated. This is important for multiplying values (I1 x F1 or I2 x F2).
Example:
I1 = 9999, F1 = 9999
I1 x F1 = 99980001
The result is within the value range.
- If no value is entered at F1 or F2, only the value at I1 and I2 is used (no multiplication).
- If the value of a control relay exceeds the value 9999, the value of the counter is shown in the display of the analog value comparator minus 10000.
Example: Counter actual value = 10233
Display of the analog value comparator: 233 (10000 is displayed as 0).

4.4.3 Parameter display in RUN mode

Parameter display and parameter set for analog value comparator in RUN mode with the display of the actual values:

| | | | |
|----|------|---|---|
| A1 | EQ | + | |
| I1 | 0249 | ↑ | — Actual value, e.g.: analog input |
| F1 | 0000 | | — Factor is not used |
| I2 | 0350 | ↓ | — Actual comparison value, e.g.: constant |
| F2 | 0000 | | — Factor is not used |
| OS | 0000 | | — Offset is not used |
| HY | 0025 | | — The switching hysteresis is +/- 25 |

4 Wiring easy with

4.4 Analog value comparator/threshold value switch

4.4.4 Resolution of the analog inputs

The analog inputs I7, I8, and on the easy700 I11, I12 have the following resolution.

The analog signal from 0 to 10 V DC is converted to a 10-bit digital value from 0 to 1023. A digital value of 100 represents an analog value of 1.0 V (exactly 0.98 V).

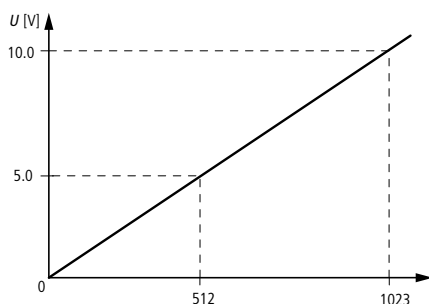

Figure 48: Resolution of the analog inputs

4.4.5 Function of the analog value comparator function relay



The GT, GE, LT, and LE comparison functions only differ in the fact that GE and LE also switch when the value is equal to the setpoint. easy400 and easy800 feature five comparison modes so that all analog value comparators from easy500 to easy700 are compatible.



WARNING

Analog signals are more sensitive to interference than digital signals. Consequently, greater care must be taken when laying and connecting the signal lines.

Set the switching hysteresis to a value so that interference signals will not cause accidental switching. A value of 0.2 V (value 20 without gain) must be observed as a safety value.

4.4.5.1 Function of the Less than comparison

```

A1 LT      +
I1 I7      †
F1 +0
I2 0100    ↓
F2 +0
OS +0
HY 0025
    
```

Parameter display and parameter set for Less than analog value comparator.

```

A1-----I01
    
```

Circuit diagram with analog value comparator.



The values F1 +0, F2 +0 and OS +0 were not defined. A gain is not used with any values. No offset is used.

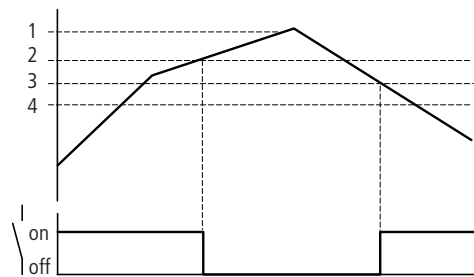

Figure 49: Signal diagram of analog value comparator in Less than mode

- 1: actual value at I7
- 2: setpoint plus hysteresis value
- 3: setpoint
- 4: setpoint minus hysteresis

The N/O contact switches off when the actual value at I7 exceeds the setpoint value plus hysteresis. If the actual value at I7 falls below the setpoint value, the N/O contact switches on.

4 Wiring easy with

4.4 Analog value comparator/threshold value switch

4.4.5.2 Function of the Less than/equal to comparison

```
A2 LE      +
I1  I7     †
F1  +0
I2  0100   ↓
F2  +0
OS  +0
HY  0025
```

Parameter display and parameter set for Less than/equal to analog value comparator.

```
A2-----I01
```

Circuit diagram with analog value comparator.



The values F1 +0, F2 +0 and OS +0 were not defined. No values are used with a gain factor, and no offset is used.

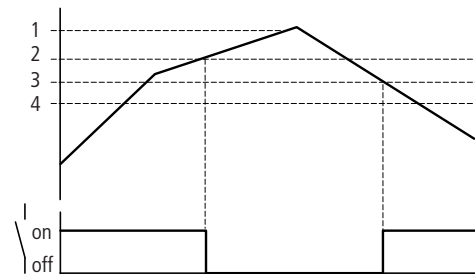

Figure 50: Signal diagram of analog value comparator in Less than/equal to mode

1: actual value at I7

2: setpoint plus hysteresis value

3: setpoint

4: setpoint minus hysteresis

The N/O contact switches off when the actual value at I7 exceeds the setpoint value plus hysteresis. If the actual value at I7 equals or falls below the setpoint value, the N/O contact switches on.

4.4.5.3 Function of the Equal to comparison

```

A8 EQ      +
I1 I8      ↑
F1 0010
I2 3000    ↓
F2 +0
OS +0
HY 0250
    
```

Parameter display and parameter set for Equal to analog value comparator.

```

A8-----I03
    
```

Circuit diagram with analog value comparator.



The values **F2 +0** and **OS +0** were not defined. No values are used with a gain factor, and no offset is used. A gain factor of 8 is used with the analog value at I10. The hysteresis is adjusted accordingly.

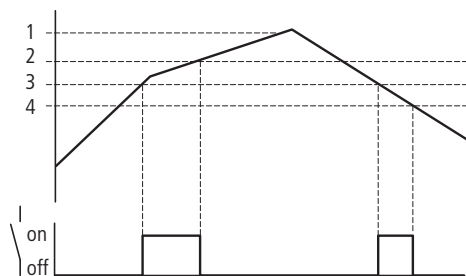

Figure 51: Signal diagram of analog value comparator in Equal to mode

- 1: actual value at I8, multiplied with gain factor F2
- 2: setpoint plus hysteresis value
- 3: setpoint
- 4: setpoint minus hysteresis

The N/O contact switches on if the actual value at I8 (multiplied by F1) reaches the configured setpoint value. If the actual value exceeds the setpoint, the make contact switches off. The N/O contact switches on if the actual value at I8 (multiplied by F1) reaches the configured setpoint value. If the actual value falls below the setpoint value minus hysteresis, the N/O contact switches off.

4 Wiring easy with

4.4 Analog value comparator/threshold value switch

4.4.5.4 Example: Function of the Greater than/equal to comparison

```
A5 GE      +
I1 I7      †
F1 +0
I2 0100    ↓
F2 +0
OS +0
HY 0025
```

Parameter display and parameter set for Greater than/equal analog value comparator.

```
A5-----I01
```

Circuit diagram with analog value comparator.



The values F1 +0, F2 +0 and OS +0 were not defined. No values are used with a gain factor, and no offset is used.

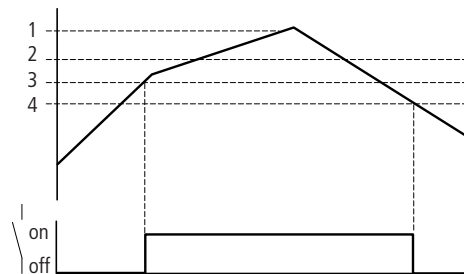

Figure 52: Signal diagram of analog value comparator in Greater than/equal to mode

- 1: actual value at I7
- 2: setpoint plus hysteresis value
- 3: setpoint
- 4: setpoint minus hysteresis

The N/O contact switches if the actual value at I7 is equal to the setpoint value. The N/O contact switches off when the actual value at I7 falls below the setpoint minus hysteresis.

4.4.5.5 Example: Function of the Greater than comparison

```
A4 GT      +
I1 I7      ↑
F1 +0
I2 0100    ↓
F2 +0
OS +0
HY 0025
```

Parameter display and parameter set for Greater than analog value comparator.

```
A4-----I01
```

Circuit diagram with analog value comparator.



The values F1 +0, F2 +0 and OS +0 were not defined. No values are used with a gain factor, and no offset is used.

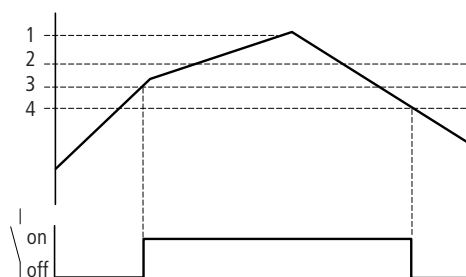

Figure 53: Signal diagram of analog value comparator in Greater than mode

- 1: actual value at I7
- 2: setpoint plus hysteresis value
- 3: setpoint
- 4: setpoint minus hysteresis

The N/O contact switches if the actual value at I7 reaches the setpoint value. The N/O contact switches off when the actual value at I7 falls below the setpoint value minus hysteresis.

4 Wiring easy with

4.4 Analog value comparator/threshold value switch

4.4.5.6 Example: Analog value comparator as two-step controller

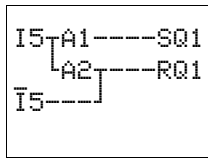

If, for example, the temperature goes below a value, A1 switches on the output Q5 with the enable input I1. If the temperature exceeds the set value, A2 will switch off. If there is no enable signal, output Q1 will always be switched off by I5.

Parameter settings of both analog value comparators:

Switch-on

| | | |
|----|------|---|
| A1 | LT | + |
| I1 | I7 | ↑ |
| F1 | +0 | |
| I2 | 0500 | ↓ |
| F2 | +0 | |
| OS | +0 | |
| HY | +0 | |

Switch-off

| | | |
|----|------|---|
| A2 | GT | + |
| I1 | I7 | ↑ |
| F1 | +0 | |
| I2 | 0550 | ↓ |
| F2 | +0 | |
| OS | +0 | |
| HY | 0015 | |

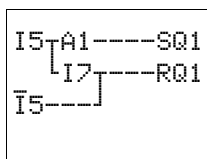

A simple circuit can be implemented if a switching point of the controller is assigned to the digital switching point of the analog input. This switching point has a 8 V DC (easy-DA, easy-DC) and 9.5 V (easy-AB) signal.

Parameter settings:

Switch-on

| | | |
|----|------|---|
| A1 | LT | + |
| I1 | I7 | ↑ |
| F1 | +0 | |
| I2 | 0500 | ↓ |
| F2 | +0 | |
| OS | +0 | |
| HY | +0 | |

Switch-off

The switch point is implemented via I7 (digital switching signal).

4.4.5.7 Example: analog value comparator, detection of operating states

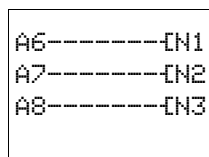

Several analog value comparators can be used to evaluate different operating states. In this case 3 different operating states are evaluated.

Parameter settings of three analog value comparators:

First operating state

```

A6 EQ      +
I1 I7      ↑
F1 +0
I2 0500    ↓
F2 +0
OS +0
HY 0025
  
```

Second operating state

```

A7 EQ      +
I1 I7      ↑
F1 +0
I2 0700    ↓
F2 +0
OS +0
HY 0025
  
```

Third operating state

```

A8 EQ      +
I1 I7      ↑
F1 +0
I2 0850    ↓
F2 +0
OS +0
HY 0025
  
```

4.4.5.8 Example: analog value comparator, comparison of two analog values

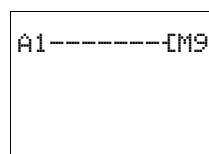

To compare two analog values, you can use the following circuit. In this case, the comparison determines whether I7 is less than I8.

```

A1 LT      +
I1 I7      ↑
F1 +0
I2 I8      ↓
F2 +0
OS +0
HY 0025
  
```

Parameter settings of the analog value comparator

4.5 Counter

easy provides 16 up/down counters C1 to C16 for use as required. The counter relays allow you to count events. You can define an upper threshold value as a comparison value. The contact will switch according to the actual value.

| Counters C1...C16 (Counter) | | | | | | |
|-----------------------------|--|-----------------|-------------|---------------------------------|--------------|---|
| Boolean inputs/outputs | | | Parameters | | | |
| Contact | Coil | | Input value | | Output value | |
| C | "1", when actual value \geq setpoint value | | | | | |
| | CC | Counter input | | | - | - |
| | DC | Count direction | | | | |
| | RC | Reset | | | | |
| | | | S | setpoint value 00000 - 32000 | | |

4.5.0.1 High-speed counters, frequency counters up to 1 kHz counter frequency.

easy-DA and easy-DC feature four high-speed counters C13 to C16. The function is defined by the mode selected. The counter input is connected directly to a digital input. The high-speed digital inputs are I1 to I4. Possible applications include the counting of components, lengths, events and frequency measurement.



The counters of easy500 and easy700 function in the same way as the counters of easy400 and easy600. If required, the same counters can be used retentively.

Table 13: Counter modes

| Counter | Operating Mode | |
|-----------|----------------|---|
| C1 to C12 | N | Up/Down Counter |
| C13, C14 | N or H | Up/down counters or high-speed up counters (easy-DA, easy-DC) |
| C15, C16 | N or F | Up/down counters or frequency counters (easy-DA, easy-DC) |

4.5.0.2 Wiring of a counter

You integrate a counter into your circuit in the form of a contact and coil. The counter relay has different coils.



Avoid unforeseeable switch states. Only use each coil of a relay once in the circuit diagram.

Do not use the input of a high-speed counter as a contact in the circuit diagram. If the counter frequency is too high only a random input value will be used in the circuit diagram.

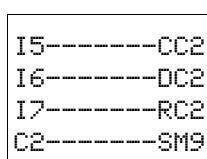

easy circuit diagram with counter relay

The coils and contacts have the following meanings:

| Contact | Coil | |
|-----------|-------------|---|
| C1 to C16 | | The contact switches if the actual value is greater than or equal to the setpoint. |
| | CC1 to CC16 | Counter input, rising edge counts |
| | DC1 to DC16 | Count direction • Coil not triggered: up counting. • Coil triggered: down counting. |
| | RC1 to RC16 | Reset, coil triggered: actual value reset to 00000 |

4.5.0.3 Parameter display and parameter set for counter relays:

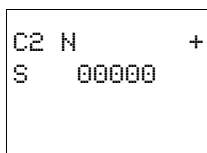

| | |
|----|--|
| C2 | Counter function relay number 2 |
| N | <ul style="list-style-type: none"> • Mode N: up/down counter • Mode H: high-speed up/down counter • Mode F: frequency counter |
| + | <ul style="list-style-type: none"> • + appears in the PARAMETER menu. • – does not appear in the PARAMETER menu |
| S | Setpoint, constant from 00000 to 32000 |

In the parameter display of a counter relay you change the mode, the setpoint and the enable of the parameter display.

4.5.0.4 Compatibility between the easy400 and easy500, easy600 and easy700: counter parameter displays

New functions have been added to the parameter display of easy500 and easy700. The easy400 and easy600 parameters can be found at the following points.

| easy400/600-Parameters | easy500/700-Parameters |
|------------------------|------------------------|
| AAAA | = S AAAAA |
| C1 | = C1 |
| + | = + |

```

[AAAA]
[ DIR ] C1
[ CNT ]
[ RES ] +
    
```

```

C1 N      +
S  AAAAA
    
```

4 Wiring easy with

4.5 Counter

4.5.0.5 Value range

The counter relay counts between 0 and 32000.

4.5.0.6 Behavior when value range is reached

The easy control relay is in RUN mode.

If the value of 32000 is reached, this value will be retained until the count direction is changed. If the value of 00000 is reached, this value will be retained until the count direction is changed.

Parameter display in RUN mode:

| | |
|------|-------|
| C1 N | + |
| S | 00309 |
| C | 00042 |

— Current setpoint, constant (0309)

— Contact has not switched.
— Contact has switched.
Actual value (00042)

4.5.0.7 Retention

Counter relays can be operated with retentive actual values. You can select the retentive counter relays in the SYSTEM... → RETENTION... menu. C5 to C7, C8 and C13 to C16 can be selected.

If a counter relay is retentive, the actual value is retained when the operating mode changes from RUN to STOP as well as when the supply voltage is switched off.

When easy is restarted in RUN mode, the counter relay continues with the retentively stored actual value.

4.5.0.8 Determining Counter Frequency

The maximum counter frequency depends on the length of the circuit diagram in easy. The number of contacts, coils and rungs used determines the run time (cycle time) required to process the easy circuit diagram.

Example: When using EASY512-DC-TC with only three rungs for counting, resetting and outputting the result via the output, the counter frequency may be 100 Hz.

The maximum counter frequency depends on the maximum cycle time.

The following formula is used to determine the maximum counter frequency:

$$f_c = \frac{1}{2 \times t_c} \times 0.8$$

f_c = maximum counter frequency

t_c = maximum cycle time

0.8 = Correction factor

Example

The maximum cycle time is $t_c = 4000 \mu\text{s}$ (4 ms).

$$f_c = \frac{1}{2 \times 4 \text{ ms}} \times 0.8 = 100 \text{ Hz}$$

4.5.1 Function of the counter function relay

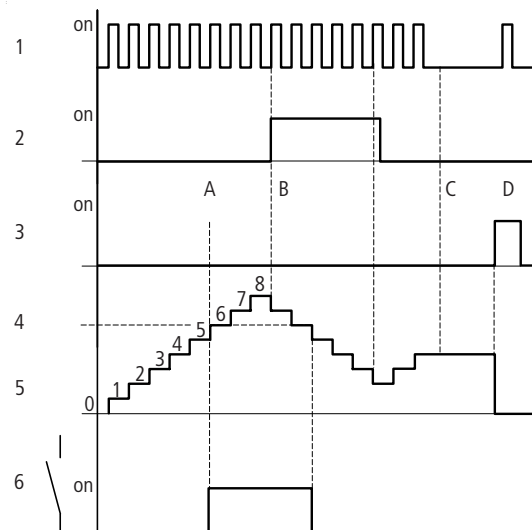

Figure 54: Signal diagram

1: Count pulses at the count coil CC...

2: Count direction, direction coil DC...

3: Reset signal at the reset coil RC...

4: Counter setpoint (the setpoint in the figure = 6)

5: actual value of the counter

6: contact of the counter, C

- Range A: The relay contact of counter C with setpoint value 6 switches when the actual value is 6.
- Range B: If the counting direction is reversed B, the contact is reset when the actual value is 5.
- Range C: Without count pulses the current actual value is retained.
- Range D: The reset coil resets the counter to 0.

4.5.1.1 Example: counters, counting unit quantities, manual counter value reset

The input I6 contains the necessary counter information and controls the count coil CC1 of counter 1. Q4 is activated if the setpoint is reached. Q4 remains switched on until I7 resets counter C1 to zero with the RC1 coil.

Circuit diagram display

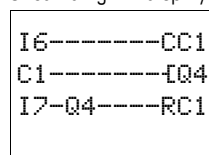

Parameter settings of the counter C1

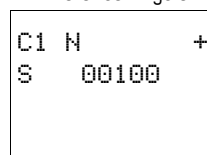

4 Wiring easy with

4.5 Counter

4.5.1.2 Example: counting unit quantities, automatic counter value reset

The input I6 contains the necessary counter information and controls the count coil CC2 of counter 2. M8 will be switched on for one program cycle if the setpoint is reached. The counter C2 is automatically set to zero by the Reset coil RC2.

Circuit diagram display

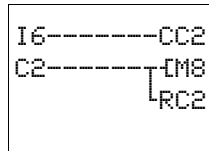

Parameter settings of the counter C2

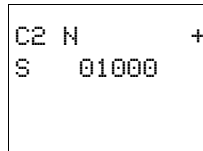

4.5.1.3 Example of a two counter cascade

Another counter is added to the previous example. As the contact of counter C2 is only set to 1 for one program cycle, the carry of counter C2 is transferred to counter C3. The counter C3 prevents further counting when its setpoint is reached.

Circuit diagram display

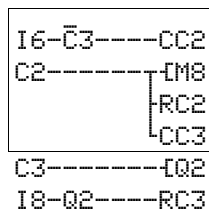

Parameter settings of the counter C2

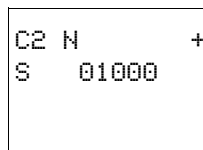

Parameter settings of the counter C3

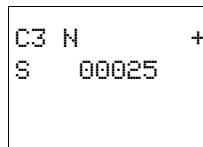

25000 pulses are counted.
 $25 \times 1000 = 25000$

4.5.1.4 Example: up/down counting with a scan for actual value = zero

The input I6 contains the necessary counter information and controls the count coil CC6 of counter 6. Marker N2 is set if the setpoint is reached. Marker N2 controls the direction coil DC6 of counter C6. If N2 is 1 (activated), counter C6 counts down. If the actual value of the counter is 00000, the analog value comparator A6 resets mark N2. The direction coil DC6 of counter C6 is switched off. Counter C6 only operates as an up counter.

Circuit diagram display Parameter settings of the counter C6

| | |
|--------------|-------------|
| I6-----CC6 | C6 N + |
| C6-----SN2 | S 01000 |
| N2-----DC6 | |
| A6-N2----RN2 | |

Parameter settings of the analog value comparator A6

| |
|--------------|
| A6 EQ + |
| I1 C6 ↑ |
| F1 +0 |
| I2 0000 ↓ |
| F2 +0 |
| OS +0 |
| HY +0 |



The above example scans the value zero. However, any permissible value within the range of the analog value comparator function block can be entered.

4.5.1.5 Example: counter with retentive actual value

Select a retentive counter if you wish to retain the actual value of a counter, even after a power failure or a change from RUN to STOP.

- ▶ Select the required counter in the SYSTEM... → RETENTION... menu.

The example shows the counters C5 to C7 as retentive counters.

| |
|-----------------|
| M 9 - M12 ↑ |
| M13 - M16 |
| N 9 - N16 |
| C 5 - C 7 √4 |
| C 8 |
| C13 - C16 |
| T 7 |
| T 8 |
| T13 - T16 |
| D 1 - D 8 |

Circuit diagram display Parameter settings of the counter C5

| | |
|--------------|-------------|
| I6-----CC5 | C5 N + |
| C5-----Q3 | S 00565 |
| I8-Q3----RC5 | |

The counter has the value 450 before the power supply is switched off.

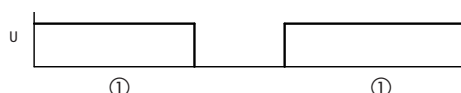

Figure 55: Retentive counter

- ① The numerical value 450 is retained even after a power outage.

U = supply voltage of the device

4 Wiring easy with

4.6 High-speed counters, easy-DA, easy-DC

4.6 High-speed counters, easy-DA, easy-DC

easy provides various high-speed counter functions. These counter function blocks are coupled directly to digital inputs. The following functions are possible:

- Frequency counters: C15 and C16
- High-speed counters: C13 and C14.

4.6.1 Frequency Counter

easy provides two frequency counters C15 and C16 for use as required. The frequency counters can be used for measuring frequencies. The high-speed frequency counters are permanently connected to the digital inputs I3 and I4.

Applications such as speed monitoring, volume measurement using a volume counter, the monitoring of machine running can be implemented with the frequency counter.

The frequency counter allows you to enter an upper threshold value as a comparison value. The C15 and C16 frequency counters are not dependent on the cycle time.

4.6.1.1 Counter frequency and pulse shape

The maximum counter frequency is 1 kHz.

The minimum counter frequency is 4 Hz.

The signals must be square waves. We recommend a mark-to-space ratio of 1:1.

If this is not the case:

The minimum mark-to-space ratio is 0.5 ms.

$$t_{\min} = 0.5 \times \frac{1}{f_{\max}}$$

t_{\min} = minimum time of the pulse or pause duration

f_{\max} = maximum count frequency (1 kHz)



The frequency counters operate independently of the program cycle time. The result of the actual value setpoint comparison is only transferred once every program cycle for processing in the circuit diagram.

The reaction time in relation to the setpoint/actual value comparison can therefore be up to one cycle in length.

4.6.1.2 Measuring procedure

The pulses on the input are counted for one second irrespective of the cycle time, and the frequency is determined. The measurement result is provided as an actual value.

4.6.1.3 Wiring of a frequency counter

The following assignment of the digital inputs apply.

- I3 counter input for frequency counter C15.
- I4 counter input for frequency counter C16.



If you use C15 or C16 as frequency counters, coils DC15 or DC16 will have no function. The counter signals are transferred directly from the digital inputs I3 and I4 to the counters. A frequency counter measures the actual value and does not measure a direction.

| |
|-------------|
| -----CC15 |
| C15-----SQ3 |
| I8-----RC15 |

You only integrate a frequency counter into your circuit in the form of a contact and enable coil. The coils and contacts have the following meanings:

| Contact | Coil | |
|-----------|------------|--|
| C15 - C16 | | The contact switches if the actual value is greater than or equal to the setpoint. |
| | CC15, CC16 | Enable of the frequency counter on "1" state, coil activated |
| | RC15, RC16 | Reset, coil triggered: actual value reset to 00000 |



The frequency counter can also be enabled specifically for a special operating state. This has the advantage that the cycle time of the device is only burdened with the frequency measurement when it is taking place. If the frequency counter is not enabled, the cycle time of the device is shorter.

4.6.1.4 Parameter display and parameter set for frequency counter:

| | | |
|-----|-------|---|
| C15 | F | + |
| S | 00246 | |

| | |
|-----|---|
| C15 | Counter function relay number 15 |
| F | Mode F: frequency counter |
| + | <ul style="list-style-type: none"> • + appears in the PARAMETER menu. • - does not appear in the PARAMETER menu |
| S | Setpoint, constant from 00000 to 01000 (32000 is a possible setting, the maximum frequency is 1 kHz) |

In the parameter display of a counter relay you change the mode, the setpoint and the enable of the parameter display.

4 Wiring easy with

4.6 High-speed counters, easy-DA, easy-DC

4.6.1.5 Value range

The counter relay counts between 4 and 1 000 [Hz].

Parameter display in RUN mode:

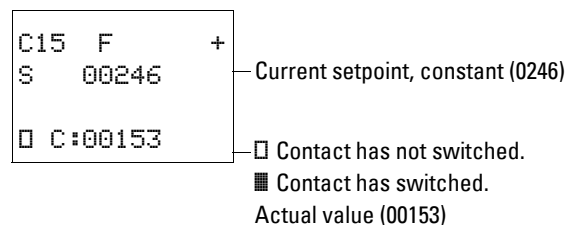

4.6.1.6 Retention

Setting retention on the frequency counter serves no purpose since the frequency is continuously remeasured.

4.6.1.7 Function of the frequency counter

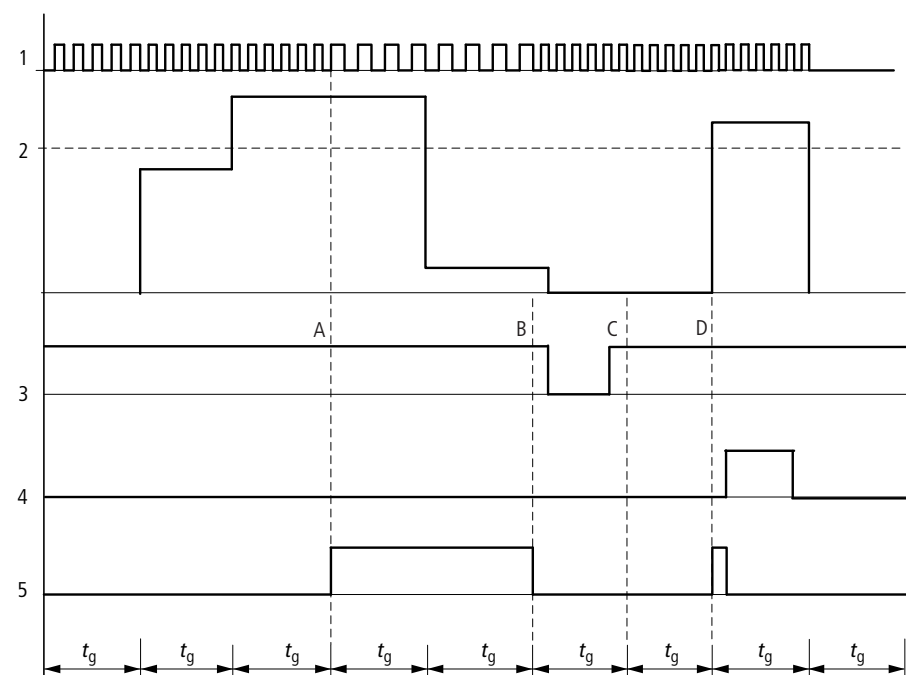

Figure 56: Signal diagram of frequency counter

1: counter input I3 or I4

2: upper setpoint

3: enable coil CC...

4: reset coil RC...

5: contact (N/O contact) C... upper setpoint value reached.

t_g : gate time for the frequency measurement

- Range A: the counter is enabled. After a frequency above the setpoint was measured for the first time, contact C15 (C16) switches.
- Range B: If the actual value falls below the setpoint, the contact is reset. The removal of the enable signal resets the actual value to zero.

- Range C: the counter is enabled. After a frequency above the setpoint was measured for the first time, contact C15 (C16) switches.
- Range D: The reset coil resets the actual value to zero.

Example: frequency counter

Frequency counters with different switch points.

The frequency measured at input I3 is to be classified in different value ranges. The analog value comparator is used as an additional comparison option.

The counter is enabled via the marker N3. The value 900 or higher is detected by frequency counter C15 as the upper limit value. This triggers the coil of marker N4.

If the frequency is higher than 600 Hz, analog value comparator A1 indicates this and triggers marker N5.

If the frequency is higher than 400 Hz, analog value comparator A2 indicates this and triggers marker N6.

Circuit diagram display

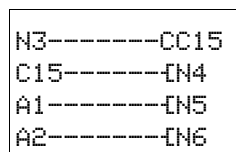

Parameter settings of the counter C15

| | | |
|-----|-------|---|
| C15 | F | + |
| S | 00900 | |

Parameter settings of the analog value comparator A1

| | | |
|----|------|---|
| A1 | GE | + |
| I1 | C115 | ↑ |
| F1 | +0 | |
| I2 | 0600 | ↓ |
| F2 | +0 | |
| OS | +0 | |
| HY | +0 | |

Parameter settings of the analog value comparator A2

| | | |
|----|------|---|
| A2 | GE | + |
| I1 | C115 | ↑ |
| F1 | +0 | |
| I2 | 0400 | ↓ |
| F2 | +0 | |
| OS | +0 | |
| HY | +0 | |

4.6.2 High-speed counters

You can use the high-speed counters to count high frequency signals reliably.

easy provides two high-speed up/down counters C13 and C14 for use as required. The high-speed counter inputs are permanently connected to the digital inputs I1 and I2. This counter relay allows you to count events independently of the cycle time.

The high-speed counters allow you to enter an upper threshold value as a comparison value. The C13 and C14 high-speed counters are not dependent on the cycle time.

4 Wiring easy with

4.6 High-speed counters, easy-DA, easy-DC

4.6.2.1 Counter frequency and pulse shape

The maximum counter frequency is 1 kHz.

The signals must be square waves. We recommend a mark-to-space ratio of 1:1.

If this is not the case:

The minimum mark-to-space ratio is 0.5 ms.

$$t_{\min} = 0.5 \times \frac{1}{f_{\max}}$$

t_{\min} = minimum time of the pulse or pause duration

f_{\max} = maximum count frequency (1 kHz)



High-speed counters operate independently of the program cycle time. The result of the actual value setpoint comparison is only transferred once every program cycle for processing in the circuit diagram.

The reaction time in relation to the setpoint/actual value comparison can therefore be up to one cycle in length.

4.6.2.2 Wiring of a high-speed counter

The following assignment of the digital inputs apply.

- I1: high-speed counter input for counter C13.
- I2: high-speed counter input for counter C14.



If you use C13 or C14 as high-speed counters you must enable them with the coil CC13 or CC14 accordingly.

| | |
|------------|------|
| ----- | CC13 |
| C13----- | SN3 |
| I6----- | DC13 |
| I8-C13---- | RC13 |

You integrate a high-speed counter into your circuit in the form of a contact and coil.

The coils and contacts have the following meanings:

| Contact | Coil | |
|-----------|------------|---|
| C13 - C14 | | The contact switches if the actual value is greater than or equal to the setpoint. |
| | CC13, CC14 | Enable of the high-speed counter on 1 signal coil activated |
| | DC13, DC14 | Counting direction <ul style="list-style-type: none"> • Status 0, not activated, up counting. • Status 1, activated, down counting. |
| | RC13, RC14 | Reset, coil triggered: actual value reset to 00000 |



The high-speed counter can also be enabled specifically for a special operating state. This has the advantage that the cycle time of the device is only burdened with the counting when it is taking place. If the high-speed counter is not enabled, the cycle time of the device is shorter.

4.6.2.3 Parameter display and parameter set for the high-speed counter:

```
C13 H +
S 00950
```

| | |
|-----|---|
| C13 | Counter function relay number 13 |
| H | H high-speed counter mode (H = high speed) |
| + | <ul style="list-style-type: none"> • + appears in the PARAMETER menu. • – does not appear in the PARAMETER menu |
| S | Setpoint, constant from 00000 to 32000 |

In the parameter display of a counter relay you change the mode, the setpoint and the enable of the parameter display.

4.6.2.4 Value range

The counter relay counts between 0 and 32000.

4.6.2.5 Behavior when value range is reached

The easy control relay is in RUN mode.

The value is retained if the counter reaches 32000. If the counter counts down and reaches 0, this value is retained.

Parameter display in RUN mode:

```
C13 H +
S 00950
```

— Current setpoint, constant (1 250)

```
☐ C:00877
```

— ☐ Contact has not switched.
 — ■ Contact has switched.
 Actual value (877)

4.6.2.6 Retention

The high-speed counter can be run with the retentive actual value. You can select the retentive counter relays in the SYSTEM... → RETENTION... menu. C5 to C7, C8 and C13 to C16 can be selected.

If a counter relay is retentive, the actual value is retained when the operating mode changes from RUN to STOP as well as when the supply voltage is switched off.

When easy is restarted in RUN mode, the counter relay continues with the retentively stored actual value.

4.6.2.7 Function of the high-speed counter function block

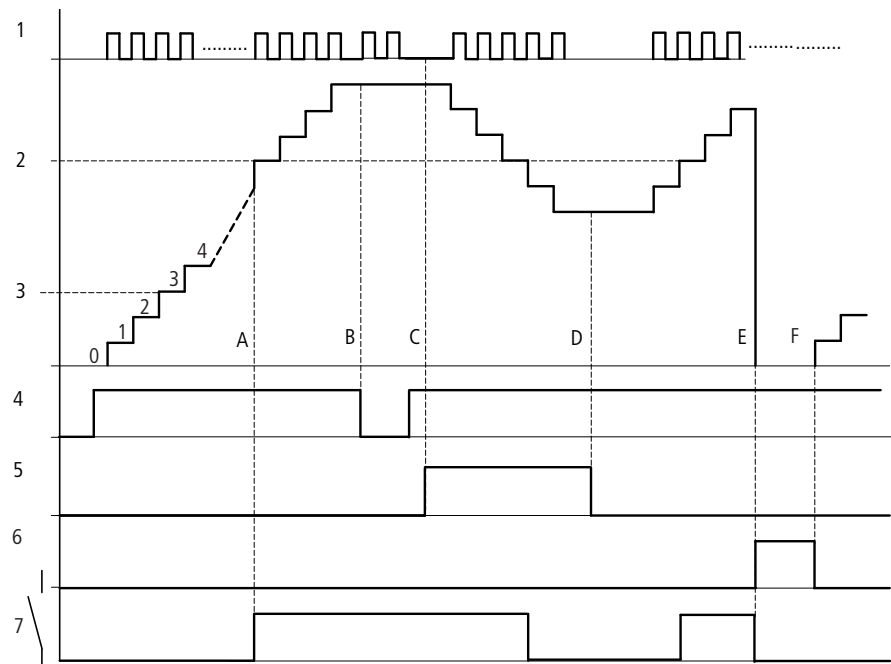

Figure 57: Signal diagram of high-speed counter

1: count pulses at counter input I1(I2)

2: setpoint of the counter

3: actual value of the counter

4: enable of the counter, CC13 (CC14)

5: count direction, direction coil DC13 (DC14)

6: reset coil of the counter RC13 (RC14)

7: contact of the counter, C13 (C14)

- Range A: The relay contact C13 (C14) of the counter with setpoint value "512" switches as soon as the actual value is "512".
- Range B: When new count pulses or the counter enable are not present, the actual value is retained.
- Range C: If the count direction is reversed DC13 (DC14), the contact is reset when the actual value is 511.
- Range D: the count direction is set to up counting.
- Range E: The Reset coil RC13 (RC14) resets the counter to "0". No pulses are counted.
- Range F: the Reset coil is not active, pulses are counted.



In the examples it must be remembered that there may be a time difference of up to one program cycle between the setpoint/actual value comparison and the processing of the result. This may cause deviations in values.

Example: counting measuring pulses and setting an output

Measuring pulses can represent lengths, rotations, angles or other values. These program sections are required for applications involving the filling of sacks, bags or the cutting of foil.

The count signals are continuously present at I1. The high-speed counter C13 counts these pulses. The counter is automatically set to zero if the actual value equals the setpoint. Contact C13 is then set for one program cycle. The output Q3 is set at the same time. This is then reset by input I8.

Circuit diagram display

Parameter settings of the counter C13

```
N1-----CC13
C13-----SQ13
C13-----RC13
I8-----RQ13
```

```
CB H      +
S      1000
```

Example: running motors or spindles in parallel.

Applications may involve motion control with the parallel control of two drives. Only certain deviations are permissible so that the mechanical system does not jam.

These tasks can be implemented with the following solution.

I8 starts the drives. I7 and I6 carry the feedback signals of the motor protective circuit breakers. The drives are stopped if a motor protective circuit breaker trips. The analog value comparators control the difference of the path distance. The appropriate drive is stopped temporarily if one path distance is outside of the set tolerance. The following applies:

- M8 = enable for all drives.
- Q1 = drive 1, counter drive 1 is connected with input I1 and this with high-speed counter C13.
- Q2 = drive 2, counter drive 2 is connected with input I2 and this with high-speed counter C14.
- A1 = comparison, if C13 is less than C14, drive 2 is too fast.
- A2 = comparison, if C14 is less than C13, drive 1 is too fast.
- A3 = comparison, if C13 and C14 are equal, both drives can be activated.
- The hysteresis value of A1, A2 and A3 depends on the resolution of the transducer and the mechanical system.

4 Wiring easy with

4.6 High-speed counters, easy-DA, easy-DC

Circuit diagram display

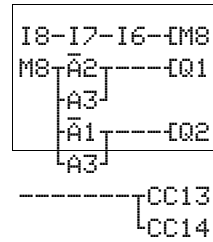

Parameter settings of the counter C13

| | | |
|-----|----|---|
| C13 | H | + |
| S | +0 | |

Parameter settings of the counter C14

| | | |
|-----|----|---|
| C14 | H | + |
| S | +0 | |

Parameter setting of analog value comparators A1 and A2

| | | |
|----|------|---|
| A1 | LT | + |
| I1 | C13 | ↑ |
| F1 | +0 | |
| I2 | C14 | ↓ |
| F2 | +0 | |
| OS | +0 | |
| HY | 0015 | |

| | | |
|----|------|---|
| A2 | LT | + |
| I1 | C14 | ↑ |
| F1 | +0 | |
| I2 | C13 | ↓ |
| F2 | +0 | |
| OS | +0 | |
| HY | 0015 | |

Parameter settings A3

| | | |
|----|------|---|
| A1 | EQ | + |
| I1 | C13 | ↑ |
| F1 | +0 | |
| I2 | C14 | ↓ |
| F2 | +0 | |
| OS | +0 | |
| HY | 0020 | |

4.7 Text Display

easy500 and easy700 can display up to 16 user-defined texts. These texts can be triggered by the actual values of function relays such as timing relays, counters, operating hours counters, analog value comparators, date, time or scaled analog values. Set values of timer relays, counters, hours run counters and analog value comparators can be altered during the display of the texts.

| Text display D1...D16 (Display) | | | |
|---------------------------------|-------------------|---------------------------------|-------------------------|
| Boolean inputs/outputs | | Parameters | |
| Contact | Coil | Input value | Output value |
| D.. | State of the coil | | |
| | D.. | 1 shows the text in the display | |
| | | OP1 | Actual value for line 2 |
| | | OP2 | Actual value for line 3 |



The text display can only be edited with the easySoft-Basic or easySoft-Pro from Version 6.xx.

The texts are saved in the easySoft file or on the EASY-M-32K memory card for easy500 and easy700.



Compatibility with easy600
If you wish to load an existing easy600 circuit diagram, the available text display functions are retained. The text display in easy500 and easy700 devices operates in the same way as in an easy600 device.

4.7.1 Wiring a text display

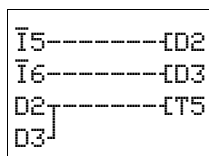

You integrate a text display into your circuit in the form of a contact and coil.

The coils and contacts have the following meanings:

| Contact | Coil | |
|----------|------------------------------|---|
| D1 - D16 | | Coil of the corresponding text display is triggered |
| | L, J, L, J, S, R D1 - D16 | If a coil is triggered, the text is shown in the display. |

The text display does not have a parameter display in the PARAMETER menu.

4.7.2 Retention

The texts D1 to D8 can be operated with retentive actual values (contacts).

4 Wiring easy with

4.7 Text Display

If the text displays are retentive, the actual value is retained when the operating mode changes from RUN to STOP as well as when the power supply is switched off.

When easy is restarted in RUN mode, the text displays D1 to D8 continue with the retentively stored actual value.

```
SWITCHING;
CONTROL;
DISPLAY;
ALL EASY!
```

Example of a text display:

The text display has the following display characteristics:

| | |
|-------------|--|
| RUNTIME M:S | — Line 1, 12 characters |
| T1 :012:46 | — Line 2, 12 characters, a setpoint or actual value |
| C1 :0355 ST | — Line 3, 12 characters, one actual value or set value |
| PRODUCED | — Line 4, 12 characters |

4.7.3 Scaling

The values of the analog inputs can be scaled.

| Area | Selectable display range | Example |
|----------|--------------------------|-------------|
| 0 - 10 V | 0 - 9999 | 0000 - 0100 |
| 0 - 10 V | ± 999 | -025 - 050 |
| 0 - 10 V | ± 9.9 | -5.0 - 5.0 |

4.7.4 Function

The D (D = "Display") text display function relay works in the circuit diagram like a normal M marker. A "1" signal at the coil will cause a stored text to be displayed in the easy display line. For this to take place, the easy must be in RUN mode and the Status display must be activated before the text is displayed.

The following rule applies to D2 to D16:

- If several texts are present and are triggered, each text is displayed automatically in turn every 4 s. This process will be repeated until:
 - No other text display function block is set to 1.
 - STOP operating mode is selected.
 - easy's power supply is no longer present.
 - A menu was selected via **OK** or **DEL + ALT**.
 - A setpoint value is entered.
 - The text for D1 is displayed.

The following function applies to D1:

- D1 is designed for alarm text. If a text has been assigned to D1 and it is activated, this text is shown permanently in the display until:
 - The coil D1 is reset to 0.

- STOP operating mode is selected.
- easy's power supply is no longer present.
- The **OK** or **DEL + ALT** buttons are used to switch to a menu.

4.7.5 Text Entry

The text entry can only be carried out with easySoft-Basic or easySoft-Pro from Version 6.xx).

4.7.6 Font

The ASCII letters can be displayed in upper and lower case.

- A B C D E F G H I J K L M N O P Q R S T U V W X Y Z
- a b c d e f g h i j k l m n o p q r s t u v w x y z
- 0 1 2 3 4 5 6 7 8 9

You can edit Cyrillic upper case letters with easy500/700 devices from version no. 10.

From easySoft version 6.x, the following special characters are permitted in addition to the blank character and 12 different graphic characters:

° ! # \$ % & ' () * + , - . / : ; < = > ? [\] ^ _ ` { | }

| Counter with actual value | Analog input scaled as temperature value | D1 as error message on fuse failure |
|---|--|---------------------------------------|
| <pre>QUANTITY PCE:0042 !COUNTING!</pre> | <pre>TEMPERATURE OUT -010 DEG IN +018 DEG HEAT..</pre> | <pre>FUSE FAULT HOUSE 1 FAILED!</pre> |

Figure 58: Text output examples

4.7.7 Entering a setpoint in a display

Two values from the following sources can be included in a text:

- actual value and setpoint of function relays,
- analog input values,
- Time and
- Date.

The position of the setpoints and actual values is defined in the middle of the 2nd and 3rd line starting from column 5. The length depends on the value to be displayed. Setpoint entries in text displays are useful if the PARAMETERS menu is not available for the display or entry. They are also used if the operator is to receive a message as to which setpoint he is to change.

4 Wiring easy with

4.7 Text Display

| | |
|-------------|---------------------------------|
| RUNTIME M:S | —Line 1 |
| T1 :012:46 | —Line 2, setpoint can be edited |
| C1 :0355 ST | —Line 3, setpoint can be edited |
| PRODUCED | —Line 4 |



The appropriate text function block in the display must be available in order to modify a setpoint. The setpoint must be a constant.



During value entry, the text is retained statically on the display. Any actual values are refreshed.

The example shows the following.

The setpoint of timing relay T1 is to be changed from 12 minutes to 15 minutes.

- Line 2: setpoint of timing relay T1, can be edited.
- Line 3: actual value of timing relay T1.

The text is displayed.

```
STIR M:S
S : 012:00
ACT:008:33
BREAD ROLLS
```

- ▶ Pressing the **ALT** button will cause the cursor to jump to the first editable value.

```
STIR M:S
S : 012:00
ACT:008:33
BREAD ROLLS
```

In this Selection mode you can use the cursor buttons $\wedge \vee$ to jump from one editable constant to another.

```
STIR M:S
S : 012:00
ACT:008:33
BREAD ROLLS
```

- ▶ Press **the OK button**, the cursor will jump to the highest digit of the constant to be modified.

In this Entry mode, you use the $\wedge \vee$ cursor buttons to change the value. The cursor buttons $\langle \rangle$ are used to move from digit to digit inside the constant.

```
STIR M:S
S : 015:00
ACT:008:34
BREAD ROLLS
```

Use the **OK** button to accept the modified value. Use the **ESC** button to abort the entry and leave the previous value.

```
STIR M:S
S : 015:00
ACT:008:34
BREAD ROLLS
```

- ▶ Pressing the **OK button** causes the cursor to return to **Selection mode**. The modified value is accepted.

Press the **ESC** button to leave Entry mode.

```
STIR M:S
S : 015:00
ACT:008:34
BREAD ROLLS
```

4.8 Weekly timer

easy500 and easy700 with type suffix EASY...-...-C are provided with a real-time clock. The time switches can only be used properly in these devices.

➔ The procedure for setting the time, (➔ section "5.4 Setting date and time", page 170).

| Weekly timer 01...08 (Week) | | | | | | | |
|-----------------------------|-------------------------|---|---|-------------|---|--------------|---|
| Boolean inputs/outputs | | | | Parameters | | | |
| Contact | Coil | | | Input value | | Output value | |
| 01 | 1 if on time is reached | - | - | - | - | - | - |

easy offers eight weekly timers 01 to 08 for up to 32 switch times.

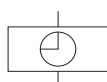

Each time switch has four channels which you can use to set four on and off times. The channels are set via the parameter display.

The timer has a back-up battery. This means that it will continue to run in the event of a power failure, although the time switch relays will not switch. The contacts are kept open when de-energized. Information on the battery back-up time are provided on (➔ Chapter 8 "Appendix", page 211).

➔ Compatibility with easy400 and easy600
If you wish to load an existing easy400 or easy600 circuit diagram, the existing weekly timer functions are retained. The weekly timer in easy500 devices and easy700 devices operates in the same way as in an easy400 device, easy600.

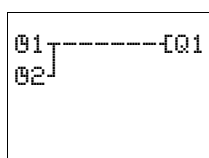

A weekly timer can be integrated into your circuit in the form of a contact.

| Contact | Coil | |
|---------|------|-----------------------------|
| 01 - 08 | | Contact of the weekly timer |

4 Wiring easy with

4.8 Weekly timer

4.8.1 Parameter display and parameter set for weekly timer:

```

01 A      +
D        S0
ON      --:--
OFF     --:--
  
```

| | |
|-------------|---|
| 01 | weekly timer function relay 1 |
| A,B, C,D | Time switch channels |
| + | <ul style="list-style-type: none"> + appears in the PARAMETER menu, - does not appear in the PARAMETER menu |
| D | Day setting, from -- to -- |
| ON | Closing delay |
| OFF | Off time |

The parameter display for a weekly timer is used to modify the weekdays, the closing delay, the break time and enable of the parameter display.

4.8.1.1 Compatibility between easy400 and easy500, easy600 and easy700: parameter display weekly timer

The parameter display for easy500 and easy700 has been changed. The easy400 and easy600 parameters can be found at the following points.

| | | | |
|--|--|--|--|
| | easy400, easy600 parameters | easy500, easy700 parameters | |
| | <pre> 011 AA-BB A ON --:-- OFF --:-- + </pre> | <pre> = 011 = AA-BB = A = ON --:-- = OFF --:-- = + </pre> | |

Table 14: On and off times

| Parameters | Meaning | Meaningful values |
|---------------|--|--------------------------------|
| Weekdays | Monday to Sunday | MO, TU, WE, TH, FR, SA, SU, -- |
| Closing delay | Hours: Minutes No time set at "--:--" | 00:00 to 23:59, --:-- |
| Off time | Hours: Minutes No time set at "--:--" | 00:00 to 23:59, --:-- |

Parameter display in RUN mode:

| | |
|-------------------------------------|--|
| | Selected channel, current time (only in RUN) |
| | Weekday(s) from - to |
| | Closing delay |
| | Off time |
| <input type="checkbox"/> | Contact has not switched. |
| <input checked="" type="checkbox"/> | Contact has switched. |

4.8.2 Changing time switch channel

You can change time switch channel in either RUN or STOP mode by selecting the channel required with the cursor buttons \wedge \vee

```

01 A 11:30 +
D   MO-FR
ON  06:45
OFF 19:30 █
    
```

Example:

The parameter display of the weekly timer is active. The cursor is flashing on channel A.

```

01 B 11:30 +
D   SA
ON  06:45
OFF 15:00 █
    
```

▶ Press the \wedge button to move the cursor to channel B.

Press the $\>$ button to reach any value that can be edited.

4.8.3 Function of the weekly timer (example parameter setting)

The following examples illustrate the function of the weekly timer.

4.8.3.1 Work days example

The time switch 01 switches on Monday to Friday between 6:30 and 9:00 and between 17:00 and 22:30.

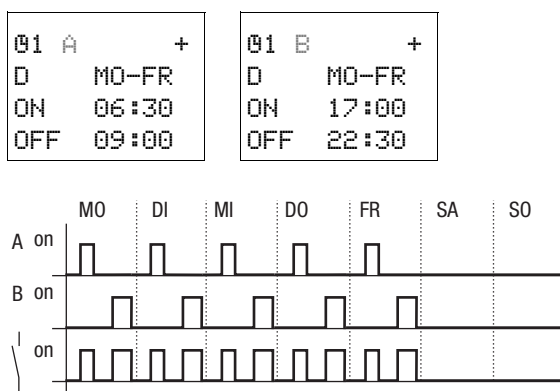

Figure 59: Work days signal diagram

4 Wiring easy with
4.8 Weekly timer

4.8.3.2 Weekends example

Time switch 02 switches on at 16:00 on Friday and switches off at 6:00 on Monday.

| | | | |
|------|-------|------|-------|
| 02 A | + | 02 B | + |
| D | FR | D | MO |
| ON | 16:00 | ON | --:-- |
| OFF | --:-- | OFF | 06:00 |

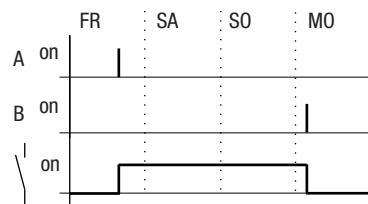

Figure 60: Signal diagram of "weekend"

4.8.3.3 Night switching example

Time switch 03 switches on at 22:00 on Monday and switches off at 6:00 on Tuesday.

| | |
|------|-------|
| 03 D | + |
| D | MO |
| ON | 22:00 |
| OFF | 06:00 |

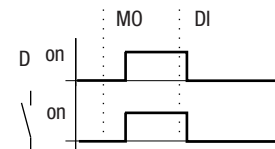

Figure 61: Night switching signal diagram



If the break time is before the closing delay, easy will switch off on the following day.

4.8.3.4 Time overlaps example

The time settings of a time switch overlap. The clock switches on at 16:00 on Monday, whereas on Tuesday and Wednesday it switches on at 10:00. On Monday to Wednesday the switching-off time is 22:00.

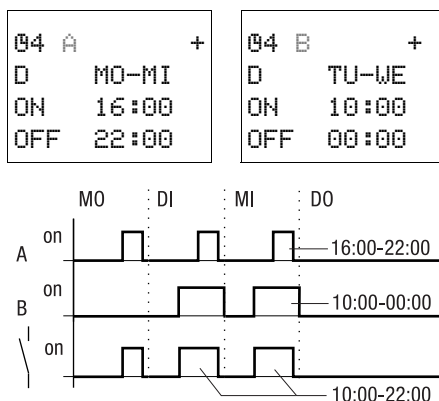

Figure 62: Time overlaps signal diagram



On and off times always follow the channel which switches first.

4.8.3.5 Power failure example

The power is removed between 15:00 and 17:00. The relay drops out and remains off, even after retriggering of the power supply, since the first break time was at 16:00.

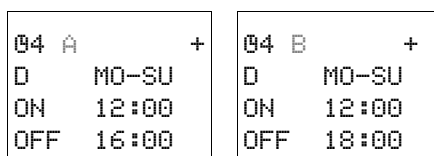

When it is switched on, easy always updates the switching state on the basis of all the available switching time settings.

4.8.3.6 24 hour switching example

The time switch is to switch for 24 hours. Switch-on time at 00:00 on Monday and switch-off time at 00:00 on Tuesday.

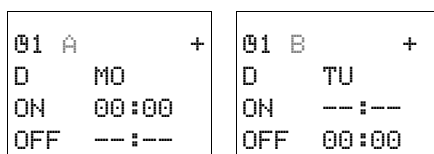

4.9 Operating Hours Counter

easy provides 4 independent operating hours counters. These operating hours counters enables you to record the operating hours of systems, machines and machine parts. An adjustable setpoint can be selected within the value range. In this way, maintenance times can be logged and reported.

| Hours-run counter 01...04 (Operating Time) | | | | | | | |
|--|--|---------|------------|-------------|--------------------|--------------|------------------|
| Boolean inputs/outputs | | | | Parameters | | | |
| Contact | | Coil | | Input value | | Output value | |
| 0. | "1", when actual value \geq setpoint value | ? . | Count coil | | | | |
| | | R. . | Reset coil | | | | |
| | | | | S | Setpoint value [h] | | |
| | | | | | | 0 | Actual value [h] |

The counter states are retained even when the device is switched off. As long as the count coil of the operating hours counter is active, easy counts the hours in second cycles.

You integrate an operating hours counter into your circuit in the form of a contact and coil.

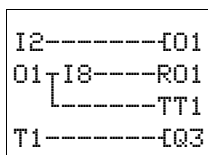

| Contact | Coil | |
|---------|-----------|---|
| 01 - 04 | | |
| | I01 - I04 | Count coil of the operating hours counter |
| | R01 - R04 | Reset coil of the operating hours counter |

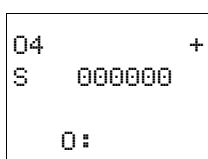

Parameter display and parameter set for the operating hours counter function block:

| | |
|----|--|
| 04 | Operating hours counter number 4 |
| + | <ul style="list-style-type: none"> + appears in the parameter display - appears in the parameter display |
| S | Setpoint in hours |
| 0: | Actual value of the operating hours counter [h] |

In the parameter display of an operating hours counter you change the setpoint in hours and the enable of the parameter display.

Parameter display in RUN mode:

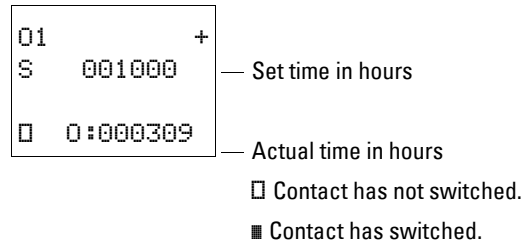

4.9.1 Value range of the operating hours counter

The operating hours counter counts in the range from 0 hours to way over 100 years.

4.9.2 Accuracy of the operating hours counter

The operating hours counter counts in seconds. When the device is switched off, up to 999 ms can be lost.

4.9.3 Function of the operating hours counter function relay

When the coil of the O operating hours counter is set to 1, the counter increments its actual value by 1 (basic pulse: 1 second).

If the actual value of the hours-run counter reaches the setpoint value of S, the contact O... switches for as long as the actual value is greater than or equal to the setpoint value.

The actual value is kept stored in the device until the Reset coil RO... is triggered. The actual value is then set to zero.



Operating mode change RUN, STOP, power On, Off, Delete program, Change program, Load new program. All these functions do not clear the actual value of the operating hours counter.

4 Wiring easy with
 4.9 Operating Hours Counter

4.9.3.1 Example: operating hours counter

Operating hours counter for the operating time of a machine. The time in which a machine (easy) is energized is to be measured.

Circuit diagram display

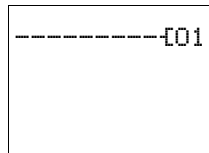

Parameter settings of operating hours counter 01

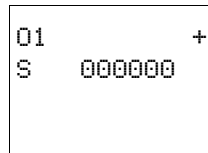

4.9.3.2 Example maintenance meter for different machine sections

Machine sections have to be maintained after different times have elapsed. Markers N1 and N2 are the On markers of two different machine sections. These markers control the associated operating hours counters. Output Q4 switches on a warning light if the setpoint of an operating hours counter has been reached. A keyswitch at input I8 resets the associated operating hours counter after maintenance has been completed.

Circuit diagram display

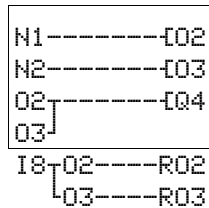

Parameter settings of operating hours counter 02

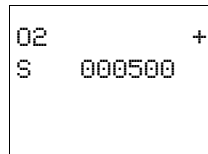

Parameter settings of operating hours counter 03

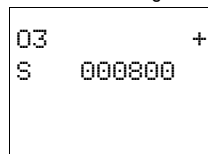

4.9.3.3 Example maintenance meter for different machine sections, with text output

The entire machine operating time is to be counted. Machine areas have to be maintained after different times have elapsed. Markers N1 and N2 are the On markers of two different machine areas. These markers control the associated operating hours counters. Output Q4 switches on a warning light if the setpoint of an operating hours counter has been reached. This should flash. A keyswitch at input I8 resets the associated operating hours counter after maintenance has been completed.

The entire machine operation time is to be displayed continuously. The run time of the machine sections should only be displayed once the maintenance interval has elapsed.

Circuit diagram display

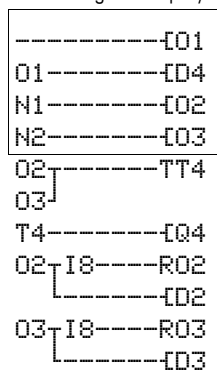

Parameter settings of operating hours counter 01

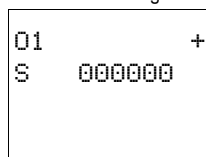

Parameter settings of operating hours counter 02

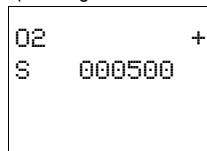

Parameter settings of operating hours counter 03

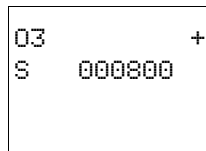

Parameter setting of timing relay T1

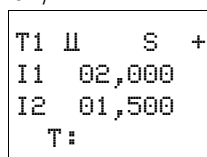

Text of text display D2

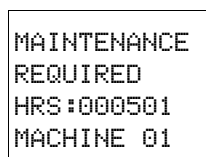

Text of text display D3

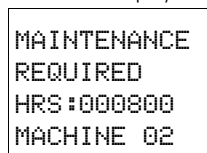

Text of text display D4

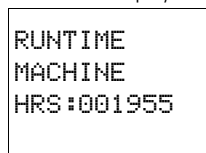

4.10 Timing Relay

easy provides 16 timing relays T1 to T16 for use as required.

A timing relay is used to change the switch time and the on and off time of a switch contact. The adjustable delay times are between 2 ms and 99 h 59 min. A time setpoint uses positive values, for example by means of a constant. You can also use variables as a time setpoint, such as the values of analog inputs or the actual values of counter relays and timing relays.

| Counters C1...C16 (Counter) | | | | | | | |
|-----------------------------|--------------------------------------|------|--------------|-------------|-----------------|--------------|--------------|
| Boolean inputs/outputs | | | | Parameters | | | |
| Contact | | Coil | | Input value | | Output value | |
| T | "1" if the on condition is fulfilled | | | | | | |
| | | DD | Trigger coil | | | | |
| | | HT | Stop coil | | | | |
| | | R T | Reset Coil | | | | |
| | | | | I1 | Time setpoint 1 | | |
| | | | | I2 | Time setpoint 2 | | |
| | | | | | | T | Actual value |

You can also use easy as a multi-function relay in the application. easy is more flexible than any hardwired timing relay since you can wire all the functions at the push of a button as well as program additional functions.



The timing relays of easy500 and easy700 function in the same way as the timing relays of easy400 and easy600 with the following exceptions:

1. easy500 and easy700:
 - The timing relay output starts with a pulse for the flash function.
 - After the Reset coil is activated, the time is set to 0. When the Reset coil is deactivated, the time count is started again at 0.
2. easy400 and easy600:
 - The timing relay output starts with a pause for the flash function.
 - The time is not counted until the trigger coil is deactivated and then reactivated.

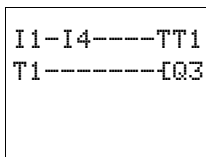

You integrate a timing relay into your circuit in the form of a contact and coil.

| Contact | Coil | |
|----------|------------|---|
| T1 - T16 | | Contact of a timing relay |
| | TT1 - TT16 | Enable, timing relay trigger |
| | RT1 - RT16 | Reset coil of the timing relay |
| | HT1 - HT16 | Stop coil of the timing relay (H = Stop, S means the Set coil function) |



Avoid unforeseeable switch states. Only use each coil of a relay once in the circuit diagram.

4.10.1 Parameter display and parameter set for a timing relay:

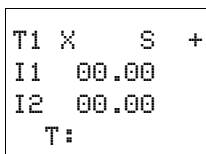

| | |
|----|---|
| T1 | Timing relay number 1 |
| X | On-time mode |
| S | Time range in seconds |
| + | <ul style="list-style-type: none"> + appears in the PARAMETER menu. - does not appear in the PARAMETER menu |
| I1 | Time setpoint 1: <ul style="list-style-type: none"> Positive value via constant or variable from I7, I8, I11, I12 (analog inputs). Variable via actual value T1 to T16, C1 to C16. |
| I2 | Time setpoint 2 (with timing relay with 2 setpoints): <ul style="list-style-type: none"> Positive value via constant or variable from I7, I8, I11, I12 (analog inputs). Variable via actual value T1 to T16, C1 to C16. |
| T: | Display of actual value in RUN mode |

In the parameter display of a timing relay you can change the mode, the time base, the time setpoint 1, time setpoint 2 (if necessary) and the enable of the parameter display.

4.10.1.1 Compatibility between the easy400 and easy500, easy600 and easy700 timing relay parameter displays

New functions have been added to the parameter display of easy500 and easy700. The easy400 and easy600 parameters can be found at the following points.

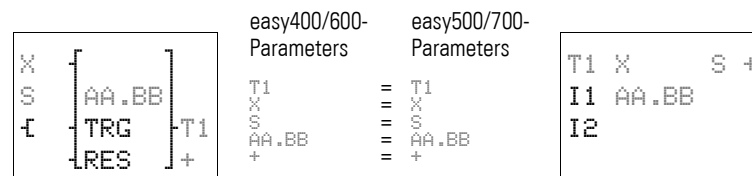

Parameter display in RUN mode:

4 Wiring easy with

4.10 Timing Relay

| | |
|------------|--------------------------------|
| T1 X S + | — Mode, time base |
| I1 10,000 | — Time setpoint 1 |
| I2 00.00 | — Time setpoint 2 |
| □ T:03.305 | — Actual value of elapsed time |
| □ | □ Contact has not switched. |
| ■ | ■ Contact has switched. |

4.10.2 Retention

Timing relays can be run with retentive actual values. Select the number of retentive timing relays in the SYSTEM... → RETENTION... menu. T7, T8, T13 to T16 can be used as retentive timing relays.

If a timing relay is retentive, the actual value is retained when the operating mode is changed from RUN to STOP and when the power supply is switched off.

When easy is restarted in RUN mode, the timing relay continues with the retentively stored actual value.



When easy is restarted, the status of the trigger pulse must be the same as on disconnection.

Status 1 with all operating modes:

- On delayed,
- Single pulse,
- Flashing.

Status 0 with all operating modes: off-delayed.

Status 1 or 0 (as with disconnection): on-delayed: on/off-delayed

4.10.3 Timing relay modes

| Parameters | Switch function |
|------------|--|
| X | On-delayed switching |
| ?X | On-delayed switching with random time range |
| ■ | Off-delayed switching |
| ?■ | Off-delayed switching with random time range |
| X■ | On- and off-delayed, two time setpoints |
| ?X■ | On- and off-delayed switching with random time, 2 time setpoints |
| ∩ | Single pulse switching |
| ∩∩ | Flash switching, mark-to-space ratio = 1:1, 2 time setpoints |
| ∩∩ | Flash switching, mark-to-space ratio = 1:1, 2 time setpoints |

4.10.4 Time Range

| Parameters | Time range and setpoint time | Resolution |
|------------|---------------------------------|------------|
| S 00.000 | Seconds: 0.00 to 99,990 s | 10 ms |
| M:S 00:00 | Minutes: Seconds 00:00 to 99:59 | 1 s |
| H:M 00:00 | Hours: Minutes, 00:00 to 99:59 | 1 min. |



Minimum time setting:

If a time value is less than the logic relay's cycle time, the elapsed time will not be recognized until the next cycle. This may cause unforeseeable switching states.

Variable values as time setpoint (analog inputs I7, I8, I11, I12, actual value T1 to T16, C1 to C16).



If the value of the variable is greater than the maximum permissible value of the configured time range, the maximum value of the time range will be used as the setpoint.

4.10.4.1 Variable time setpoints



If you are using analog values as time setpoints, ensure that the value of the analog input is stable. Oscillating analog values deteriorate the reproducibility of the time value.

When using variable values, such as the actual value of a different timing relay, easy will only accept its output value with the conversion. The time range selected for this timing relay is ignored.

The following conversion rules apply:

For "s" time base

With the time base "s" the value is accepted as a "value in ms". The last position is rounded up to a zero or five.

Equation: Time setpoint = (Value x 10) in [ms]

| Value, e.g. Analog input | Time setpoint in [s] |
|--------------------------|----------------------|
| 0 | 00.00 |
| 100 | 01.00 |
| 300 | 03.00 |
| 500 | 05.00 |
| 1023 | 10.23 |

4 Wiring easy with

4.10 Timing Relay

For "M:S" time base

With the time base "M:S" the value is accepted as a "value in s".

Rule:

Time setpoint = Value divided by 60 Integer result = Number of hours,
remainder is the number of minutes

| Value, e.g. Analog input | Time setpoint in [M:S] |
|--------------------------|------------------------|
| 0 | 00:00 |
| 100 | 01:40 |
| 300 | 05:00 |
| 500 | 08:20 |
| 1023 | 17:03 |

For time base H:M

With the time base "H:M:" the value is accepted as a "value in M (minutes)".

Rule:

Time setpoint = Value divided by 60, integer result = Number of hours,
remainder is the number of minutes

| Value, e.g. Analog input | Time setpoint in [H:M] |
|--------------------------|------------------------|
| 0 | 00:00 |
| 100 | 01:40 |
| 300 | 05:00 |
| 606 | 10:06 |
| 1023 | 17:03 |

4.10.5 Function of the timing relay function relay

4.10.5.1 Timing relay, on delayed with and without random switching

Time value I1: on-delay time

Random switching: The contact of the timing relay switches randomly within the setpoint value range.

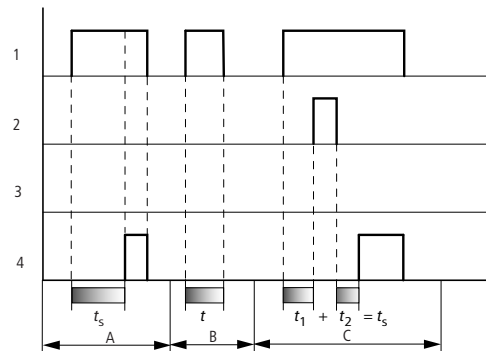

Figure 63: Signal diagram of timing relay, on-delayed (with and without random switching)

- 1: trigger coil TTx
- 2: Stop coil HTx
- 3: Reset coil RTx
- 4: Switch contact (make) Tx

t_s : Setpoint time

- Range A: The set time elapses normally.
- Range B: The entered setpoint does not elapse normally because the trigger coil drops out prematurely.
- Range C: The Stop coil stops the time from elapsing.

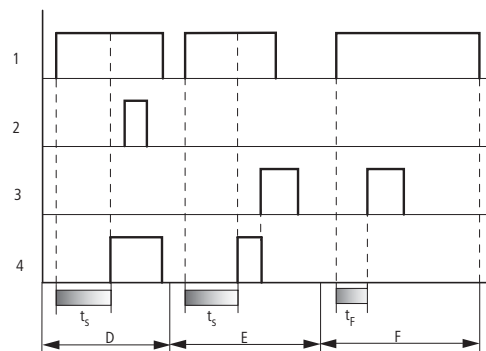

Figure 64: Signal diagram of timing relay, on-delayed (with and without random switching)

- Range D: The Stop coil is inoperative after the time has elapsed.
- Range E: The Reset coil resets the relay and the contact.
- Range F: After the reset coil is activated, the switching contact is switched off and the internal time counter is reset. The function relay waits for a new trigger pulse.

Retriggering during response delay

If the trigger coil drops out while the on-delay time is running down, the timing relay stops the on-delay time and resets the actual value t to 0. After the trigger coil is set again, the entire on-delay time is run down.

4.10.5.2 Timing relay, off delayed with and without random switching

Time value I1: Off-delay time

Random switching: The contact of the timing relay switches randomly within the setpoint value range.

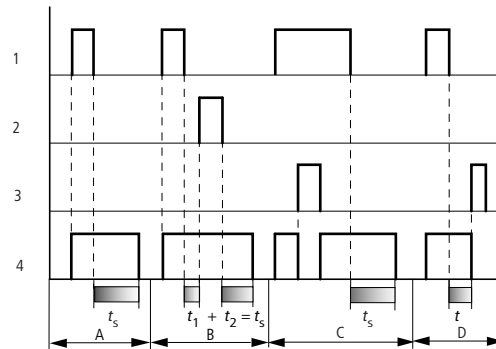

Figure 65: Signal diagram of timing relay, off-delayed (with and without random switching)

- 1: trigger coil TTx
- 2: Stop coil HTx
- 3: Reset coil RTx
- 4: Switch contact (N/O) Tx

t_s : setpoint time

- Range A: The time elapses after the trigger coil is deactivated.
- Range B: The Stop coil stops the time from elapsing.
- Range C: The Reset coil resets the relay and the contact. After the Reset coil drops out, the relay continues to work normally.
- Range D: The Reset coil resets the relay and the contact when the function block is timing out.

Retriggering during the off-delay

If the trigger coil is activated again while the off-delay time is running down, the timing relay stops the off-delay time and resets the actual value t to 0. After the trigger coil is reset, the entire off-delay time set is run down.

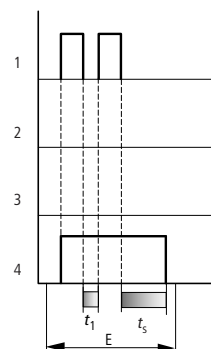

Figure 66: Signal diagram of timing relay, off-delayed (with/without random switching with retriggering)

Range E: The trigger coil drops out twice. The actual time t_1 is cleared and the set time t_s elapses completely (retriggerable switch function).

4.10.5.3 Timing relay, on delayed and off delayed with and without random switching

Time value I1: on-delay time

Time value I2: off-delay time

Operating mode with Random switching: The contact of the timing relay switches randomly within the setpoint value ranges.

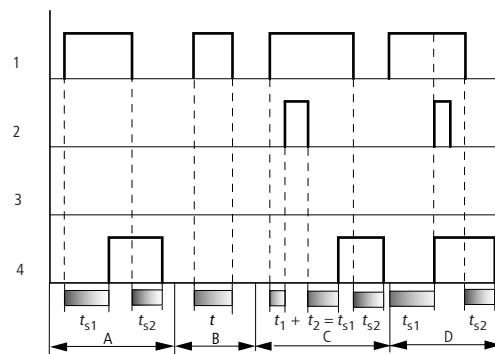

Figure 67: Operational diagrams timing relay, on and off delayed 1

- 1: trigger coil TTx
- 2: Stop coil HTx
- 3: Reset coil RTx
- 4: Switch contact (N/O) Tx

t_{s1} : pick-up time

t_{s2} : drop-out time

- Range A: The relay processes the two times without any interruption.
- Range B: The trigger coil drops out before the on-delay is reached.
- Range C: The stop coil stops the timeout of the on-delay.
- Range D: The stop coil has no effect in this range.

The description of the retriggering during the on-delay is provided on
→ Chapter 4 "Wiring easy with", page 127

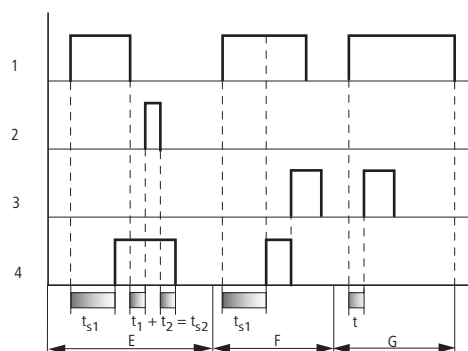

Figure 68: Operational diagrams timing relay, on and off delayed 2

- Range E: The stop coil stops the timeout of the off-delay.
- Range F: The Reset coil resets the relay after the on delay has elapsed
- Range G: After the reset coil is activated, the internal time counter is reset. The switching contact remains switched off. The function relay waits for a new trigger pulse.

4 Wiring easy with

4.10 Timing Relay

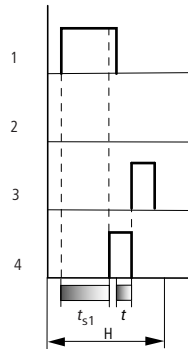

Figure 69: Operational diagrams timing relay, on and off delayed 3

- Range H: The Reset pulse interrupts the run down of the time and sets the elapsed time to 0.

If the trigger coil is activated again whilst the off-delay time is running down, the off-delay time is stopped.

Retriggering during the off-delay

In on-delay and off-delay mode, the behavior of the timing relay when it is retriggered during the off-delay depends on the parameter setting and the actual value t :

- setpoint value I1 \geq reference value I2

If the trigger coil is activated again, the actual time t is stopped. The off-delay time does not run down until the trigger coil drops out.

- **Setpoint value I1 < Setpoint value I2**

- Actual time $t <$ Setpoint value I1

If the trigger coil is actuated again, the actual time t is stopped. The off-delay time does not run down until the trigger coil drops out.

- Actual time $t \geq$ Setpoint value I1

If the trigger coil is actuated again, the actual time t is set to 0. If the trigger coil subsequently drops out, the set off-delay time is run down again.

This behavior is also the same for on-delay and off-delay modes with random switching.

4.10.5.4 Timing relay, single pulse

Time value I1: Pulse time

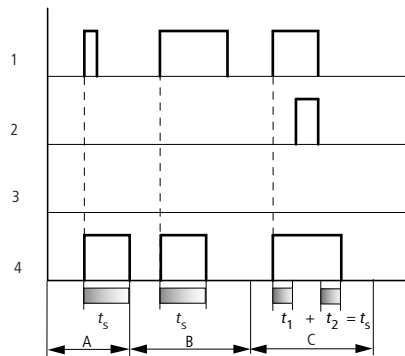

Figure 70: Signal diagram timing relay, single pulse 1

1: trigger coil TTx

2: Stop coil HTx

3: Reset coil RTx

4: Switch contact (N/O) Tx

- Range A: The trigger signal is short and is lengthened
- Range B: The trigger signal is longer than the set time.
- Range C: The stop coil interrupts the timing out of the set time.

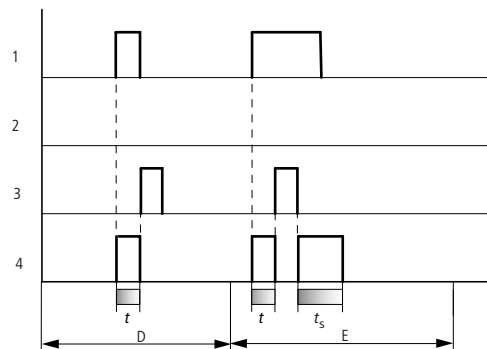

Figure 71: Operational diagram timing relay, pulse shaping 2

- Range D: The reset coil resets the timing relay.
- Range E: The reset coil resets the timing relay. The Trigger coil is still activated after the Reset coil has been deactivated and the time is still running.

4 Wiring easy with

4.10 Timing Relay

4.10.5.5 Timing relay, flashing

You can set the mark to space ratio to 1:1 or \neq 1:1.

Time value I1: mark time

Time value I2: space time

Mark-to-space ratio=1:1 flashing: S1 equals S2. Mark-to-space ratio \neq 1:1 flashing: S1 not equal S2.

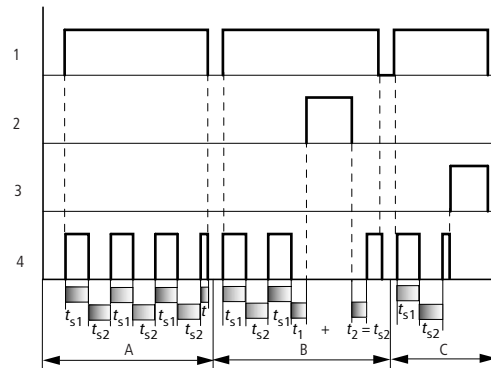

Figure 72: Timing relay signal diagram, flashing

1: trigger coil TTx

2: Stop coil HTx

3: Reset coil RTx

4: Switch contact (N/O) Tx

- Range A: The relay flashes for as long as the Trigger coil is activated.
- Range B: The stop coil interrupts the timing out of the set time.
- Range C: The reset coil resets the relay.

4.10.6 Examples timing relay

4.10.6.1 Example: timing relay, on-delayed

In this example a conveyor belt starts 10 s after the system is powered up.

Circuit diagram display

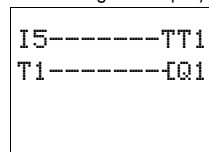

Parameter settings of timing relay T1

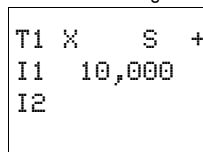

4.10.6.2 Example: timing relay, off-delayed

The off-delayed function is used to implement a rundown time on the conveyor if required.

Circuit diagram display

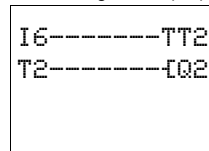

Parameter settings of timing relay T2

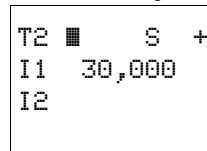

4.10.6.3 Example: timing relay, on- and off-delayed

The on/off-delayed function is used to implement the delay of both the startup and the disconnection if required.

Circuit diagram display

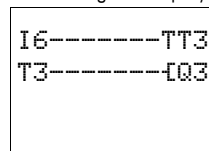

Parameter settings of timing relay T3

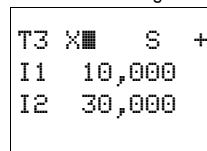

4.10.6.4 Example: timing relay, single pulse

The input pulses present may vary in length. These pulses must be normalized to the same length. The Single pulse function can be used very simply to implement this.

Circuit diagram display

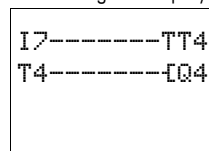

Parameter settings of timing relay T4

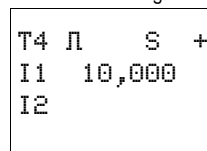

4.10.6.5 Example: timing relay, flashing

This example shows a continuous flash pulse function. Outputs Q3 or Q4 flash according to the marker states of M8 or M9.

Circuit diagram display

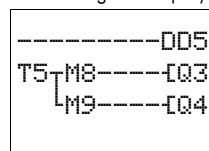

Parameter settings of timing relay T5

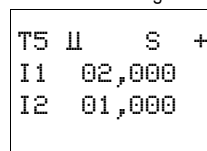

4 Wiring easy with

4.10 Timing Relay

4.10.6.6 Example: on-delayed timing relay with retentive actual value

Select a retentive timing relay if you wish to retain the actual value of a timing relay, even after a power failure or a change from RUN to STOP.

► Select the required timing relay in the SYSTEM... → RETENTION... menu.

The example shows the timing relays T7, T8 as retentive timing relays. Markers M9 to M12 were also selected as retentive.

```

M 9 - M12 √+
M13 - M16
N 9 - N16
C 5 - C 7 ↓
C 8
C13 - C16
T 7      √
T 8      √
T13 - T16
D 1 - D 8
  
```

Circuit diagram display

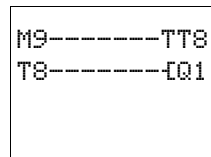

Parameter settings of timing relay T8

```

T8 X  M:S +
I1  15:00
I2
  
```

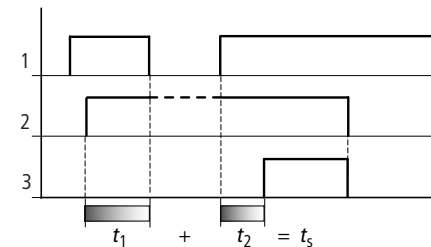
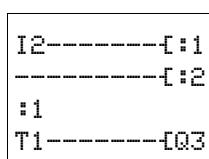

Figure 73: Function of the circuit

- 1: power supply
- 2: status of marker M9 and thus trigger signal T8
- 3: status of make contact T8

4.11 Jumps

Jumps can be used to optimize the structure of a circuit diagram or to implement the function of a selector switch. Jumps can be used for example to select whether manual/automatic operation or other machine programs are to be set.



| Jumps #1 to #8 | | Boolean inputs/outputs | | Parameters | |
|----------------|------------------|------------------------|---------------|------------|---|
| Contact | Coil | Input value | Output value | | |
| x: | Jump Destination | [x | Jump Location | - | - |

You integrate #1 jumps into your circuit in the form of a contact and coil. Jumps consist of a jump location and a jump label.

| Contact | Coil |
|--|----------------|
| #1 to #8 (can only be used as first leftmost contact) | |
| | [#11 to [#18 |

4.11.1 Function

If the jump coil is triggered, the rungs after the jump coil are no longer processed. The states of the coils before the jump will be retained, unless they are overwritten in rungs that were not missed by the jump. Jumps are always made forwards, i.e. the jump ends on the first contact with the same number as that of the coil.

- Coil = Jump when 1
- Contact only at the first leftmost contact = Jump label

The "Jump label" contact point is **always set to "1"**.



Backward jumps are not possible with easy due to the way it operates.

If the jump label does not come after the jump coil, the jump will be made to the end of the circuit diagram. The last rung will also be skipped.

Multiple use of the same jump coil and jump contact is possible as long as this is implemented in pairs, i.e.:

Coil [#1/jumped range/Contact #1, Coil [#1/jumped range/
Contact #1 etc.

CAUTION

If rungs are skipped, the states of the coils are retained. The time of started timing relays continues to run.

4 Wiring easy with

4.11 Jumps

4.11.2 Power Flow Display

Jumped sections are indicated by the coils in the power flow display.

All coils after the jump coil are shown with the symbol **■ ■** of the jump coil.

4.11.2.1 Example

A selector switch allows two different sequences to be set.

- Sequence 1: Switch on motor 1 immediately.
- Sequence 2: Switch on Guard 2, Wait time, then switch on Motor 1.

Contacts and relays used:

- I1 sequence 1
- I2 sequence 2
- I3 guard 2 moved out
- I12 motor protective circuit breaker switched on
- Q1 motor 1
- Q2 guard 2
- T1 wait time 30.00 s, on-delayed
- D1 text "Motor protective circuit breaker tripped"

Circuit diagram:

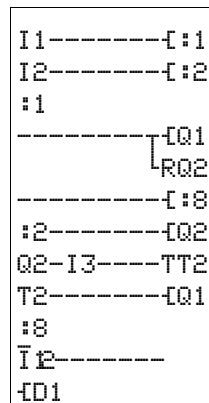

Power flow display: I1 selected:

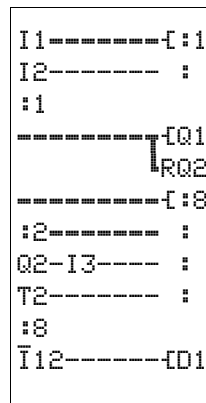

Section from jump label 1 processed.

Jump to label 8.

Section to jump label 8 skipped.

Jump label 8, circuit diagram processed from this point on.

4.12 Year Time Switch

easy500 and easy700 with type designation EASY...-...**C**. are fitted with a real-time clock and thus allow the use of weekly timer and year time switch function relays.

| Year time switch Y1...Y8 (Year) | | | | | | | |
|---------------------------------|-------------------------|--|--|-------------|---|--------------|---|
| Boolean inputs/outputs | | | | Parameters | | | |
| Contact | Coil | | | Input value | | Output value | |
| Y | 1 | | | - | - | - | - |
| | 1 if on time is reached | | | | | | |

4.12.1 Function

If you have to implement special on and off switching functions on public holidays, vacations, company holidays, school holidays and special events, these can be implemented easily with the year time switch.

➔ The procedure for setting the time is described under
➔ Section "5.4 Setting date and time" on page 170.

easy offers eight year time switches Y1 to Y8 for up to 32 switch times.

For each year time switch four channels A, B, C and D are available. You can choose an on and off switching time for every channel. These channels of a year time switch all act jointly on the contact Y that you include in the circuit diagram. The channels are set via the parameter display or easySoft.

The year time switch can switch **recurrent intervals** by switching them on and off for individual days, months or years. They can also switch **continuous time ranges** in which they can be set to stay on at the beginning of any day to the end of any day, month or year.

➔ The parameters for the switch-on and switch-off times for recurring intervals are configured in **one** single channel for each. The parameters for the **switch-on and switch-off times** for a continuous period of time are configured in **two** neighbouring channels (A and B or B and C).

4 Wiring easy with

4.12 Year Time Switch

4.12.2 Behavior in the event of a power failure

The time and date are backed up in the event of a power supply failure and continue to run. This means that it will continue to run in the event of a power failure, although the time switch relays will not switch. The contacts are kept open when de-energized. Refer to → Section "8.3 Technical data", page 211, for information on the buffer time.



The clock module integrated in easy works within the date range 2001-01-01 to 2099-12-31

4.12.3 Wiring of a year time switch

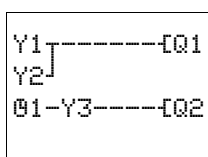

You can only include a year time switch in your circuit diagram as a Y.. contact.

The coils and contacts have the following meanings:

| Contact | Coil | |
|----------|------|---------------------------------|
| Y1 to Y8 | | Contact of the year time switch |

4.12.4 Parameter display and parameter set for year time switch

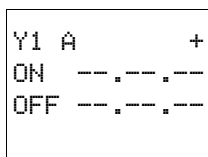

| | |
|-------------|---|
| Y1 | Year time switch function relay 1 |
| A,B, C,D | Time switch channels |
| + | <ul style="list-style-type: none"> + appears in the PARAMETER menu. - does not appear in the PARAMETER menu |
| ON | On date: day, month, year (two-digit 2010 = 10) |
| OFF | Off date: day, month, year (two-digit 2011 = 11) |

The parameter display for a year time switch is used to modify the closing delay, the break time and the enable of the parameter display.

Table 15: On and off times

| Parameters | Meaning | Meaningful values |
|------------|-----------------|-------------------|
| xx.--.00 | Date, day | 01 to 31 |
| --.xx.00 | Month | 01 to 12 |
| ---.00 | Year, two-digit | 00 to 99 |

Parameter display in RUN mode:

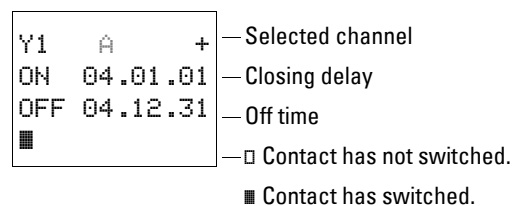

4.12.5 Changing time switch channel

You can change time switch channel in either RUN or STOP mode by selecting the channel required with the cursor buttons \wedge \vee

```
Y4 A      +
ON  04.01.01
OFF 04.03.31
█
```

Example:

The display on the left shows the parameter display of a year time switch. The cursor is flashing on channel A.

```
Y4 B      +
ON  04.10.01
OFF 04.12.31
□
```

▶ Press the \wedge button to move the cursor to channel B.

You can use the $\>$ button to reach any editable value.

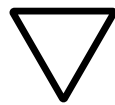

Caution - important input rules!

The year time switch only operates correctly if you observe the following rules:

- The On year must be before the Off year,
- ON and OFF times must be specified the same in pairs.

Example of entries in pairs:

- ON = Day/--/--, OFF = Day/--/--

The ON day should normally have a smaller value than the OFF day, otherwise the special case applies

(→ section " Example 8: Selecting a time range of two days spanning the turn of the year (2-channel)", page 145).

- ON = --/--/Year, OFF = --/--/Year,
- ON = --/Month/Year, OFF = --/Month/Year
- ON = Day/Month/Year, OFF = Day/Month/Year

4 Wiring easy with

4.12 Year Time Switch

4.12.6 Entry rules

The following nine entry rules are possible.

Display format: XX = digit used

4.12.6.1 Rule 1

```
Y1  A  +
ON  XX.---.---
OFF XX.---.---
```

ON: Day

OFF: Day

4.12.6.2 Rule 2

```
Y1  A  +
ON  --.XX.---
OFF --.XX.---
```

ON: Month

OFF: Month

4.12.6.3 Rule 3

```
Y1  A  +
ON  --.---.XX
OFF --.---.XX
```

ON: Year

OFF: Year

4.12.6.4 Rule 4

```
Y1  A  +
ON  XX.XX.---
OFF XX.XX.---
```

ON: Day/month

OFF: Day/month

4.12.6.5 Rule 5

```
Y1  A  +
ON  --.XX.XX
OFF --.XX.XX
```

ON: Month/year

OFF: Month/year

4.12.6.6 Rule 6

```
Y1  A  +
ON  XX.XX.XX
OFF XX.XX.XX
```

ON: Day/month/year
OFF: Day/month/year

4.12.6.7 Rule 7

```
Y1  A  +
ON  XX.XX.--
OFF --.--.--
```

Two-channel
Channel A ON: Day/month

```
Y1  B  +
ON  --.--.--
OFF XX.XX.--
```

Channel B OFF: Day/month

4.12.6.8 Rule 8

```
Y1  B  +
ON  XX.XX.XX
OFF --.--.XX
```

Two-channel
Channel ON: Day/month/year

```
Y1  D  +
ON  --.--.XX
OFF XX.XX.XX
```

Channel D OFF: Day/month/year

With this rule, the same year number must be entered in each channel in the ON and OFF entry area.

4.12.6.9 Rule 9

Overlapping channels:
The first ON date switches on and the first OFF date switches off.

Overlapping channels:
The first ON date switches on and the first OFF date switches off.

4 Wiring easy with

4.12 Year Time Switch

4.12.7 Function of the year time switch

The year time switch can switch ranges, individual days, months, years or combinations of all three.

4.12.7.1 Years

ON: 2002 to OFF: 2010 means:
Recurring interval, switch on at 00:00 2002-01-01 00:00 and off at 00:00 2011-01-01.

4.12.7.2 Months

ON: 04 to OFF: 10 means:
Recurring interval, switch on at 00:00 April 1, and off at 00:00 November 1.

4.12.7.3 Days

ON: 02 to OFF: 25 means:
Recurring interval, switch on at 00:00 on day 2 of the month and off at 00:00 day 26, i.e. after the set day has fully elapsed.



Avoid making incomplete entries. It hinders transparency and leads to unwanted functions.

4.12.8 Year time switch for sample parameter configurations

4.12.8.1 Configuring the parameters for recurring intervals

Example 1: Selecting year range (1-channel)

The year time switch Y1 is required to switch on at 00:00 on January 1 2010 and stay on until 00:00 January 1 2012.

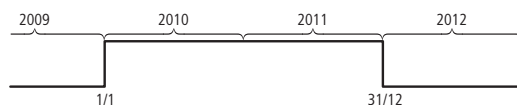
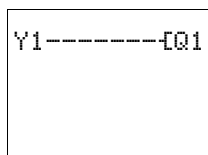
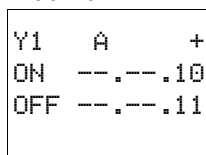

Figure 74: Select year range

Circuit diagram display



Parameter settings of the year time switch Y1



4.12.8.2 Example 2: Selecting month ranges (1-channel)

The year time switch Y2 is required to switch on at 00:00 on March 1 and stay on until 00:00 October 1.

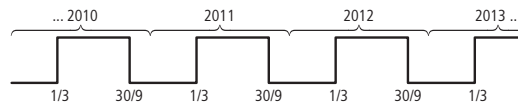
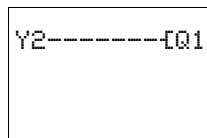
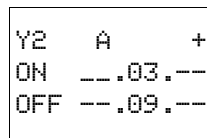

Figure 75: Select month range

Circuit diagram display



Parameter settings of the year time switch Y2



4.12.8.3 Example 3: Selecting day ranges (1-channel)

The year time switch Y3 is required to switch on at 00:00 on day 1 of each month and switch off at 00:00 on day 29 of each month.

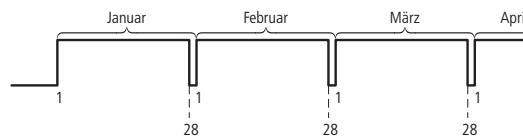
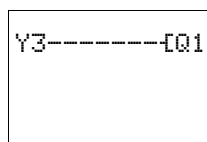
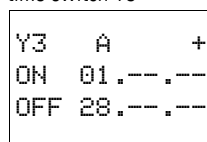

Figure 76: Select day range

Circuit diagram display



Parameter settings of the year time switch Y3



4.12.8.4 Example 4: Selecting public holidays (1-channel)

The year time switch Y4 is required to switch on at 00:00 on day 25.12 of each year and switch off at 00:00 on day 27.12 of each year. "Christmas program".

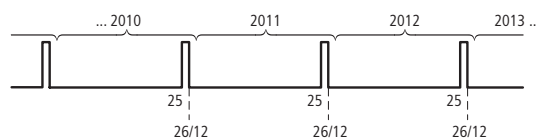
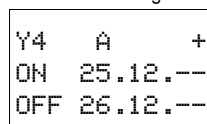

Figure 77: Select public holiday

Circuit diagram display



Parameter settings of the year time switch Y4



4.12.8.5 Example 5: Specific days of specific months (1-channel)

The year time switch Y01 is required to switch on at 0:00 on day 9 of months 6, 7, 8, 9 and 10 of each year and switch off at 00:00 on day 17 of the month.

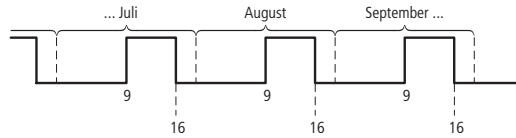
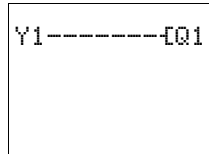
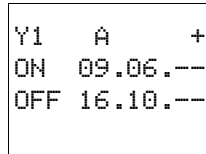

Figure 78: Chose specific days of specific months

Circuit diagram display



Parameter settings of the year time switch Y1



4.12.8.6 Configuring the parameters for continuous periods of time

The following examples show how to configure the parameters for continuous periods of time in which the time switch remains continuously switched on. The parameter definition is carried out in pairs on two adjacent channels.

Example 6: Time range for each year (2-channel)

The year time switch Y1 is required to switch on at 00:00 on day 02.05 of **each year** and stay on continuously until 00:00 on 1.11 of each year. "Open air season".

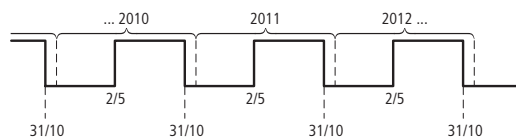
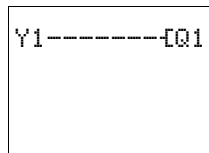
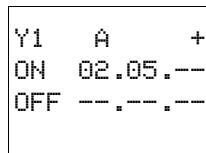

Figure 79: Select time range for each year

Circuit diagram display



Parameter settings of the year time switch Y1



①
②

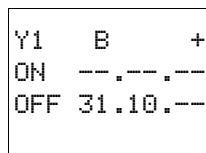

③
④

- ① + ② First and last on year as well as
- ③ + ④ First and last off year are unlimited here

Example 7: Selecting a time range for a limited number of years (2-channel)

The Y1 year time switch should switch on at 00:00, on 05/02, in the years 2011 and 2012, and remain switched on until 00:00 on 11/1 in each case.

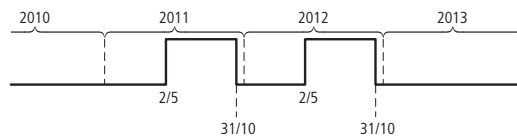

Figure 80: Select a time range for a limited number of years

| | |
|-------------------------|---|
| Circuit diagram display | Parameter settings of the year time switch Y1 |
| Y1-----[Q1] | Y1 A + ON 02.05.11 ① OFF --.---.12 ② |
| | Y1 B + ON --.---.11 ③ OFF 12.10.31 ④ |

- ① First and ② last on year.
- ③ First and ④ last off year.

Example 8: Selecting a time range of two days spanning the turn of the year (2-channel)

The Y1 year time switch should switch on at 00:00 on 12/31 of **every year** and remain continuously switched on until 00:00 on 02/01 of every year.

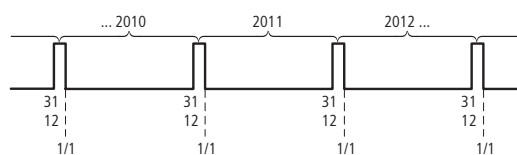

Figure 81: Select a time range of two days spanning the turn of the year

| | |
|-------------------------|---|
| Circuit diagram display | Parameter settings of the year time switch Y1 |
| Y1-----[Q1] | Y1 A + ON 31.12.-- ① OFF --.---.-- ② |
| | Y1 B + ON --.---.-- ③ OFF 01.01.-- ④ |

- ① + ② First and last on year as well as
- ③ + ④ First and last off year are unlimited here

Example 9: Selecting a time range of two days spanning the turn of the year on 2010/2011, 2011/2012 (2-channel)

The Y1 year time switch should switch on at 00:00 on 12/31 of 2010 and remain switched on until 00:00 on 01/02 of 2011, and switch on at 00:00 on 12/31 of 2011 and remain switched on until 00:00 on 01/02 of 2012.

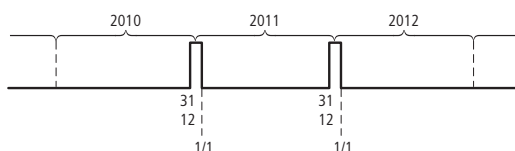

Figure 82: Select a time range of two days spanning the turn of the year

| | |
|-------------------------|---|
| Circuit diagram display | Parameter settings of the year time switch Y1 |
| Y1-----[Q1 | Y1 A + ON 31.12.10 ① OFF --.---.11 ② |
| | Y1 B + ON --.---.11 ③ OFF 12.01.01 ④ |

- ① First and ② last on year.
- ③ First and ④ last off year.

Example 10: Overlapping time ranges (2-channel)

This example shows how to configure the parameters for continuous overlapping time ranges on adjacent channels.

The Y1 year time switch, **channel C**, switches on at 00:00 on the third of months 5, 6, 7, 8, 9, 10 and remains switched on until 00:00 on the 26th of these months.

The Y1 year time switch, **channel D**, switches on at 00:00 on the second of months 6, 7, 8, 9, 10, 11, 12 and remains switched on until 00:00 on the 18th of these months.

| | |
|-------------------------|---|
| Circuit diagram display | Parameter settings of the year time switch Y1 |
| Y1-----[Q1 | Y1 C + ON 03.05.-- ① OFF 25.10.-- |
| | Y1 D + ON 02.06.-- ② OFF 17.12.-- |

Total result corresponding to the channel configurations and behavior of contact Y1 in this example:

The time switch switches on at 00:00 on 3 May and stays on until 00:00 on 26 May.

In June, July, August, September, October, the time switch will switch on at 00:00 on day 2 of the month and switch off at 00:00 on day 18.

In November and December, the time switch will switch on at 00:00 on the second of the month and switch off until 00:00 on the 18th. The following note explains this switching behavior.



Switching behavior with overlapping channel settings:

If parameterized ranges overlap, the year time switch switches the contact on with the first detected **ON**, irrespective of which channel supplies this **ON** signal. In the same way, the year time switch switches the contact off with the first detected **OFF**, irrespective of whether another channel still supplies the **ON** signal!

4.13 Master Reset

The master reset function relay enables you to set with one command the status of the markers and all outputs to "0". Depending on the operating mode of this function relay, it is possible to reset the outputs only, or the markers only, or both. Three function blocks are available.

| Master reset Z1...Z3 (central reset) | | | | | | | |
|--------------------------------------|-------------------|------|----------------------------------|-------------|---|--------------|---|
| Boolean inputs/outputs | | | | Parameters | | | |
| Contact | | Coil | | Input value | | Output value | |
| Z1 | State of the coil | | | | | | |
| | | ↯1 | Reset of outputs Q | - | - | - | - |
| | | ↯2 | Reset of marker ranges M.. + N.. | | | | |
| | | ↯3 | Reset all | | | | |

4.13.0.1 Wiring of the master reset function relay

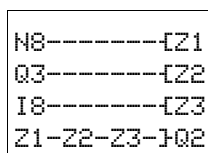

You integrate a master reset function relay into your circuit in the form of a contact and coil.

The coils and contacts have the following meanings:

| Contact | Coil | |
|---------|-------------|-----------------------------|
| Z1 - Z3 | | Contact of the master reset |
| | ↯Z11 - ↯Z13 | Coil of the master reset |

4 Wiring easy with

4.13 Master Reset

4.13.1 Operating modes

The different coils of the master reset have different operating modes:

- Z1: For Q outputs: controls outputs Q1 to Q8 and S1 to S8.
- Z2: For markers M, N: controls the marker range M1 to M16 and N1 to N16.
- Z3: for outputs and markers: controls Q1 to Q8, S1 to S8, M1 to M16 and N1 to N16.

4.13.2 Function of the master reset function relay

A rising edge or the "1" signal on the coil will reset the outputs or markers to "0", depending on the operating mode set. The location of the coil in the circuit diagram is of no importance. The master reset always has the highest priority.

The contacts Z1 to Z3 follow the status of their own coil.

4.13.2.1 Example: resetting outputs

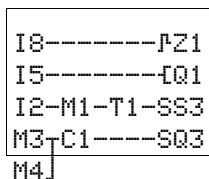

All outputs that you have used can be reset to 0 with one command.

A rising edge at the coil of Z1 will cause all Q and S outputs to be reset.

4.13.2.2 Example: resetting markers

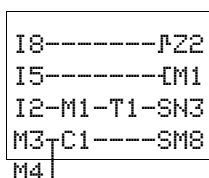

All markers that you have used can be reset to 0 with one command.

A rising edge at the coil of Z2 will cause all markers M and N to be reset.

4.13.2.3 Example: resetting outputs and markers

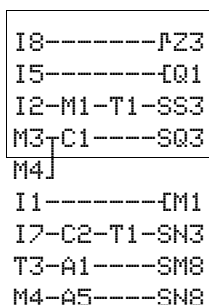

All outputs and markers that you have used can be reset to 0 with one command.

A rising edge at the coil of Z3 will cause all Q and S outputs and all M and N markers to be reset.

4.14 Basic circuits

The values in the logic table have the following meanings

For switch contacts:

- 0 = N/O contact open, N/C contact closed
- 1 = N/O contact closed, N/C contact open

For Q...: relay coils

- 0 = coil not energized
- 1 = coil energized

4.14.1 Negation (contact)

Negation means that the contact opens rather than closes when it is actuated (NOT circuit).

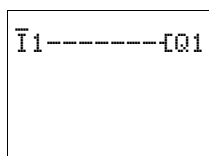

In the easy circuit diagram, press the **ALT** button to toggle contact I1 between N/C and N/O contact.

Table 16: Negation

| I1 | Q1 |
|----|----|
| 1 | 0 |
| 0 | 1 |

4.14.2 Negation (coil)

Negation means in this case that the coil opens when the N/O contact is actuated (NOT circuit).

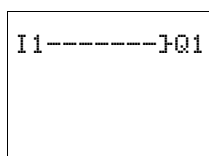

In the easy circuit diagram example, you only change the coil function

Table 17: Negation

| I1 | Q1 |
|----|----|
| 1 | 0 |
| 0 | 1 |

4.14.3 Permanent contact

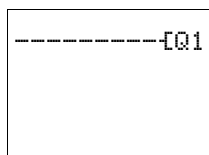

To energize a relay coil continuously, make a connection of all contact fields from the coil to the leftmost position.

Table 18: Permanent contact

| --- | Q1 |
|-----|----|
| ... | 1 |

4 Wiring easy with

4.14 Basic circuits

4.14.4 Series circuit

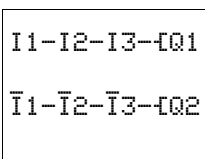

Q1 is controlled by a series circuit consisting of three make contacts (AND circuit).

Q2 is controlled by a series circuit consisting of three break contacts (NOR circuit).

In the easy circuit diagram, you can connect up to three N/O or N/C contacts in series within a rung. Use M marker relays if you need to connect more than three N/O contacts in series.

Table 19: Series circuit

| I1 | I2 | I3 | Q1 | Q2 |
|----|----|----|----|----|
| 0 | 0 | 0 | 0 | 1 |
| 0 | 0 | 1 | 0 | 0 |
| 0 | 1 | 0 | 0 | 0 |
| 0 | 1 | 1 | 0 | 0 |
| 1 | 0 | 0 | 0 | 0 |
| 1 | 0 | 1 | 0 | 0 |
| 1 | 1 | 0 | 0 | 0 |
| 1 | 1 | 1 | 1 | 0 |

4.14.5 Parallel connection

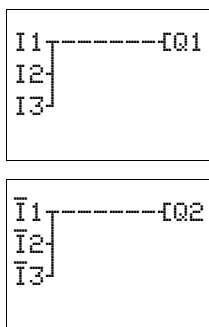

Q1 is controlled by a parallel circuit consisting of several N/O contacts (OR circuit).

A parallel circuit of N/C contacts controls Q2 (NAND circuit).

Table 20: Parallel connection

| I1 | I2 | I3 | Q1 | Q2 |
|----|----|----|----|----|
| 0 | 0 | 0 | 0 | 1 |
| 0 | 0 | 1 | 1 | 1 |
| 0 | 1 | 0 | 1 | 1 |
| 0 | 1 | 1 | 1 | 1 |
| 1 | 0 | 0 | 1 | 1 |
| 1 | 0 | 1 | 1 | 1 |
| 1 | 1 | 0 | 1 | 1 |
| 1 | 1 | 1 | 1 | 0 |

4.14.6 Parallel circuit operating like a series connection of make contacts

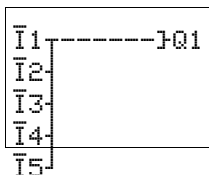

A series circuit with more than three contacts (N/O contacts) can be implemented with a parallel circuit of N/C contacts on a negated coil.

In the easy circuit diagram you can switch as many rungs in parallel as you have rungs available.

Table 21: Parallel connection of N/C contacts on a negated coil

| I1 | I2 | I3 | I4 | I5 | Q1 |
|----------|----------|----------|----------|----------|----------|
| 0 | 0 | 0 | 0 | 0 | 0 |
| 0 | 0 | 0 | 0 | 1 | 0 |
| 0 | 0 | 0 | 1 | 0 | 0 |
| 0 | 0 | 0 | 1 | 1 | 0 |
| 0 | 0 | 1 | 0 | 0 | 0 |
| 0 | 0 | 1 | 0 | 1 | 0 |
| 0 | 0 | 1 | 1 | 0 | 0 |
| 0 | 0 | 1 | 1 | 1 | 0 |
| 0 | 1 | 0 | 0 | 0 | 0 |
| 0 | 1 | 0 | 0 | 1 | 0 |
| 0 | 1 | 0 | 1 | 0 | 0 |
| 0 | 1 | 0 | 1 | 1 | 0 |
| 0 | 1 | 1 | 0 | 0 | 0 |
| ... | ... | ... | ... | ... | 0 |
| ... | ... | ... | ... | ... | 0 |
| 1 | 1 | 1 | 1 | 1 | 1 |

4 Wiring easy with

4.14 Basic circuits

4.14.7 Parallel circuit operating like a series connection of break contacts

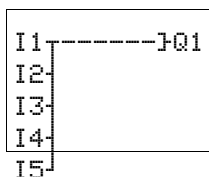

A series circuit with more than three contacts (N/C contacts) can be implemented with a parallel connection of N/O contacts on a negated coil.

In the easy circuit diagram you can switch as many rungs in parallel as you have rungs available.

Table 22: Parallel connection of N/O contacts on a negated coil

| I1 | I2 | I3 | I4 | I5 | Q1 |
|-----|-----|-----|-----|-----|----|
| 0 | 0 | 0 | 0 | 0 | 1 |
| 0 | 0 | 0 | 0 | 1 | 0 |
| 0 | 0 | 0 | 1 | 0 | 0 |
| 0 | 0 | 0 | 1 | 1 | 0 |
| 0 | 0 | 1 | 0 | 0 | 0 |
| 0 | 0 | 1 | 0 | 1 | 0 |
| 0 | 0 | 1 | 1 | 0 | 0 |
| 0 | 0 | 1 | 1 | 1 | 0 |
| 0 | 1 | 0 | 0 | 0 | 0 |
| 0 | 1 | 0 | 0 | 1 | 0 |
| ... | ... | ... | ... | ... | 0 |
| ... | ... | ... | ... | ... | 0 |
| 1 | 1 | 1 | 1 | 1 | 0 |

4.14.8 Two way switch

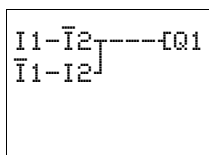

A two-way circuit is made in easy using two series connections that are combined to form a parallel circuit (XOR).

An XOR circuit stands for an “**Ex**clusive **Or**” circuit. The coil is only energized if one contact is activated.

Table 23: Two-way circuit (XOR)

| I1 | I2 | Q1 |
|----|----|----|
| 0 | 0 | 0 |
| 0 | 1 | 1 |
| 1 | 0 | 1 |
| 1 | 1 | 0 |

4.14.9 Self maintaining

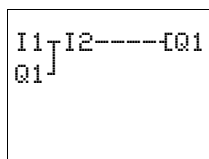

S1 N/O contact at I1
S2 N/C contact on I2

A combination of a series and parallel connection is used to wire a latching circuit.

Latching is established by contact Q1 which is connected in parallel to I1. When I1 is actuated and reopened, the current flows via contact Q1 until I2 is actuated.

Table 24: Self maintaining

| I1 | I2 | Contact Q1 | Coil Q1 |
|----|----|------------|---------|
| 0 | 0 | 0 | 0 |
| 0 | 1 | 0 | 0 |
| 1 | 0 | 0 | 0 |
| 1 | 1 | 0 | 1 |
| 0 | 0 | 1 | 0 |
| 0 | 1 | 1 | 1 |
| 1 | 0 | 1 | 0 |
| 1 | 1 | 1 | 1 |

Latching circuits are used to switch machines on and off. The machine is switched on at the input terminals via normally open contact S1 and is switched off via normally closed contact S2.

S2 breaks the connection to the control voltage in order to switch off the machine. This ensures that the machine can be switched off, even in the event of a wire break. I2 is always closed when not actuated.

Alternatively the latching circuit can also be set up with the wire break function using the "Set" and "Reset" coil functions.

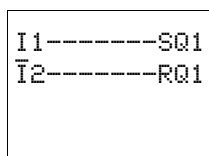

S1 N/O contact at I1
S2 N/C contact on I2

Coil Q1 latches if I1 is activated. I2 inverts the break contact signal of S2 and only switches if S2 is activated in order to disconnect the machine or in the event of a wire breakage.

Make sure that both coils are wired up in the correct order in the easy circuit diagram: first wire the S coil and then the R coil. This will ensure that the machine will be switched off when I2 is actuated, even if I1 is switched on.

4 Wiring easy with

4.14 Basic circuits

4.14.10 Impulse relays

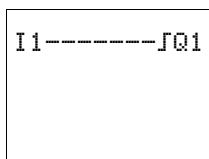

S1 N/O contact at I1

An impulse relay is often used for controlling lighting, such as stairwell lighting.

Table 25: Impulse relays

| I1 | Status of Q1 | Q1 |
|----|--------------|----|
| 0 | 0 | 0 |
| 0 | 1 | 1 |
| 1 | 0 | 1 |
| 1 | 1 | 0 |

4.14.11 Cycle pulse on rising edge

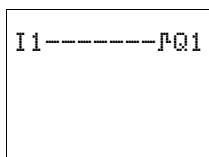

S1 N/O contact at I1

You can create a cycle pulse on a rising edge if you use the appropriate coil function.

This is very useful for count pulses, jump pulses.

Table 26: Cycle pulse on rising edge

| I1 | Status of Q1 cycle n | Status of Q1 cycle n + 1 |
|----|----------------------|--------------------------|
| 0 | 0 | 0 |
| 1 | 1 | 0 |
| 0 | 0 | 0 |

4.14.12 Cycle pulse on falling edge

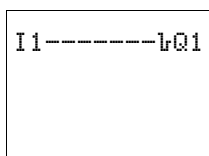

S1 N/O contact at I1

You can create a cycle pulse on a falling edge if you use the appropriate coil function.

This is very useful for count pulses, jump pulses.

Table 27: Cycle pulse on falling edge

| I1 | Status of Q1 cycle n | Status of Q1 cycle n + 1 |
|----|----------------------|--------------------------|
| 1 | 0 | 0 |
| 0 | 1 | 0 |
| 1 | 0 | 0 |

4.15 Circuit examples

4.15.1 Star-delta starting

You can implement two star-delta circuits with easy. The advantage of easy is that it is possible to select the changeover time between star and delta contactors, and also the time delay between switching off the star contactor and switching on the delta contactor.

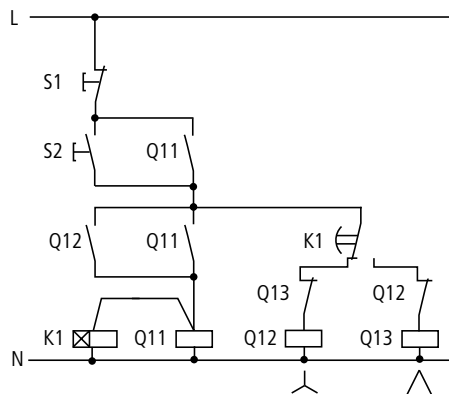

Figure 83: Star-delta circuit with conventional contactors

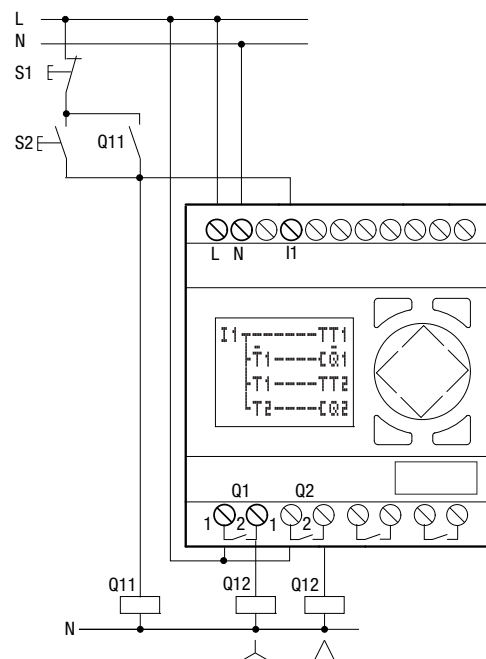
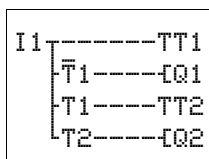

Figure 84: Star-delta circuit with easy

4 Wiring easy with

4.15 Circuit examples

4.15.1.1 Function of the easy-circuit diagram:



Start/Stop of circuit with the external actuators S1 and S2. The mains contactor starts the timing relay in the logic relay.

- I1: Mains contactor switched on
- Q1: Star contactor ON
- Q2: Delta contactor ON
- T1: Star-delta changeover time (10 to 30 s, X)
- T2: Wait time between star off, delta on (30, 40, 50, 60 ms, X)

If your easy has an integral time switch, you can combine star-delta starting with the time switch function. In this case, use easy to also switch the mains contactor.

4.15.2 4x shift register

You can use a shift register for storing an item of information, such as for the sorting of parts into good and bad, for two, three or four transport steps further on.

A shift pulse and the value ("0" or "1") to be shifted are needed for the shift register.

The shift register's Reset input is used to clear any values that are no longer needed. The values in the shift register go through the register in the order: 1st, 2nd, 3rd, 4th storage location.

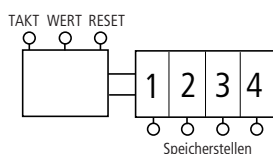

Figure 85: Block diagram of the 4-way shift register

Table 28: Shift Register

| Pulse | Value | Storage position | | | |
|-----------|-------|------------------|---|---|---|
| | | 1 | 2 | 3 | 4 |
| 1 | 1 | 1 | 0 | 0 | 0 |
| 2 | 0 | 0 | 1 | 0 | 0 |
| 3 | 0 | 0 | 0 | 1 | 0 |
| 4 | 1 | 1 | 0 | 0 | 1 |
| 5 | 0 | 0 | 1 | 0 | 0 |
| Reset = 1 | | 0 | 0 | 0 | 0 |

Assign the information “bad” to value 0. Should the shift register be accidentally deleted, no bad parts will be reused.

- I1: Shift pulse (PULSE)
- I2: Information (good/bad) to be shifted (VALUE)
- I3: Clear content of the shift register (RESET)
- M1: 1st storage location
- M2: 2nd storage location
- M3: 3rd storage location
- M4: 4th storage location
- M7: Marker relay for cycle pulse
- M8: Cyclical pulse for shift pulse

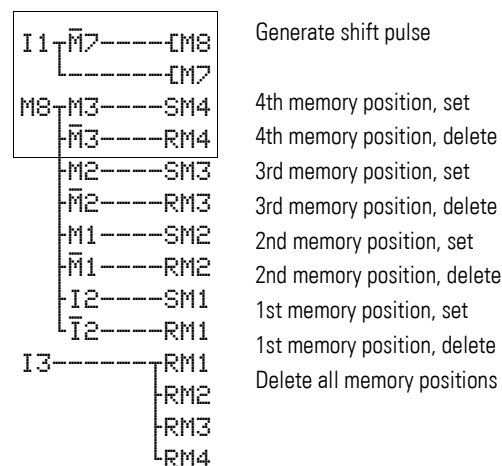

Figure 86: easy circuit diagram shift register

4.15.2.1 How does the shift register work?

The shift pulse is activated for exactly one cycle. To do this, the shift pulse is generated by evaluating the change from I1 OFF to I1 ON – the rising edge.

In this way, therefore, the cyclical processing of easy is used to trigger the shift pulse.

When I1 is activated for the first time, the marker relay N/C contact M7 is closed during the first pass through the cycle. Thus, the series connection consisting of I1, N/C contact M7 (closed) and M8 is activated. Although M7 is now also activated, this does not yet have any effect on contact M7.

The contact of M8 (N/O contact) was still open during the first cycle so a shift pulse cannot yet be generated. When the relay coil is activated, easy transfers the result to the contacts.

In the second cycle N/C contact M7 is open. The series connection is opened. The contact M8 is activated from the result of the first cycle. Now, all the storage locations are either set or reset in accordance with the series connection.

4 Wiring easy with

4.15 Circuit examples

If the relay coils were activated, easy transfers the result to the contacts. M8 is now open again. No new pulse can be formed until I1 has opened, since M7 is open for as long as I1 is closed.

4.15.2.2 How does the value reach the shift register?

When shift pulse M8 = ON, the state of I2 (VALUE) is transferred to storage location M1.

If I2 is activated, M1 is set. If I2 is deactivated, M1 is deactivated via break contact I2.

4.15.2.3 How is the result shifted?

easy activates the coils in accordance with the rung and its result, from top to bottom. M4 assumes the value of M3 (value 0 or 1) before M3 assumes the value of M2. M3 assumes the value of M2, M2 the value of M1 and M1 the value of I2.

4.15.2.4 Why are the values not constantly overwritten?

In this example, the coils are controlled only by the S and R functions, i.e. the values are retained in on or off states even though the coil is not constantly activated. The state of the coil changes only if the rung up to the coil is activated. In this circuit, the marker relay is therefore either set or reset. The rungs of the coils (storage locations) are only activated via M8 for one cycle time. The result of activating the coils is stored in easy until a new pulse changes the state of the coils.

4.15.2.5 How are all the storage locations cleared?

When I3 is activated, all the R coils of storage locations M1 to M4 are reset, i.e. the coils are deactivated. Since the reset was entered at the end of the circuit diagram, the reset function has priority over the set function.

4.15.2.6 How can the value of a storage location be transferred?

Use the N/O or N/C contact of storage locations M1 to M4 and wire them to an output relay or in the circuit diagram according to the task required.

4.15.3 Running light

An automatic running light can be created by slightly modifying the shift register circuit.

One relay is always switched on. It starts at Q1, runs through to Q4 and then starts again at Q1.

The marker relays for storage locations M1 to M4 are replaced by relays Q1 to Q4.

| | | | |
|----|-------|---|---|
| T1 | U | S | + |
| I1 | 00.50 | | |
| I2 | 00.50 | | |

The shift pulse I1 has been automated by the flasher relay T1. The cycle pulse M8 remains as it is.

On the first pass, the value is switched on once by N/C contact M9. If Q1 is set, M9 is switched on. Once Q4 (the last storage location) has been switched on, the value is passed back to Q1.

Try changing the times.

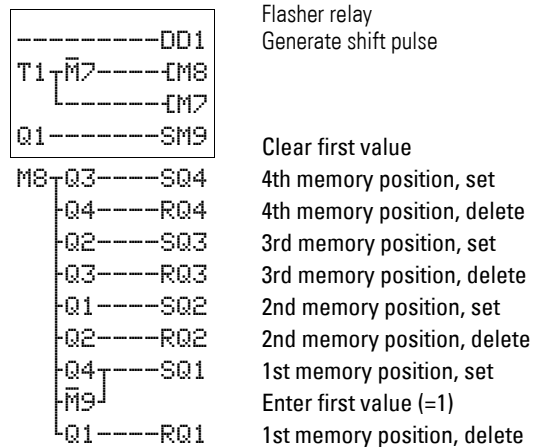

Figure 87: easy run light circuit diagram

4 Wiring easy with
4.15 Circuit examples

4.15.4 Stairwell lighting

For a conventional circuit you would need at least five space units in the distribution board, i.e. one impulse relay, two timing relays and two auxiliary relays.

easy requires only four space units. A fully functioning stairwell lighting system can be set up with five terminals and the easy circuit diagram.

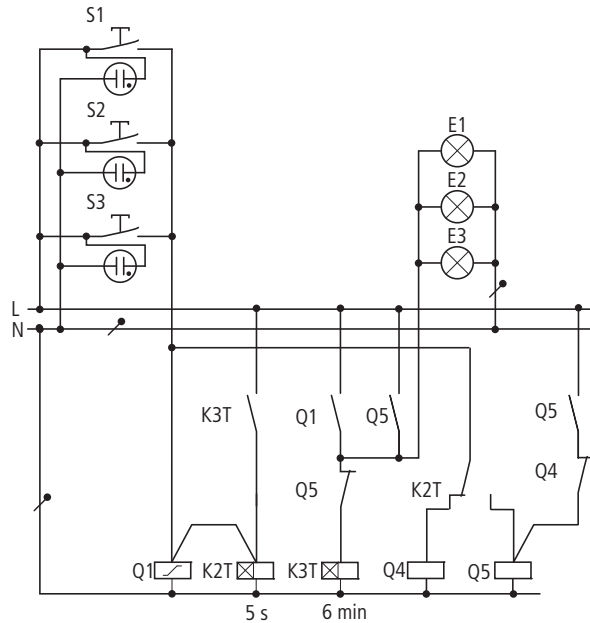

Figure 88: Conventional stairwell lighting



Up to twelve such stairwell circuits can be implemented with one easy device.

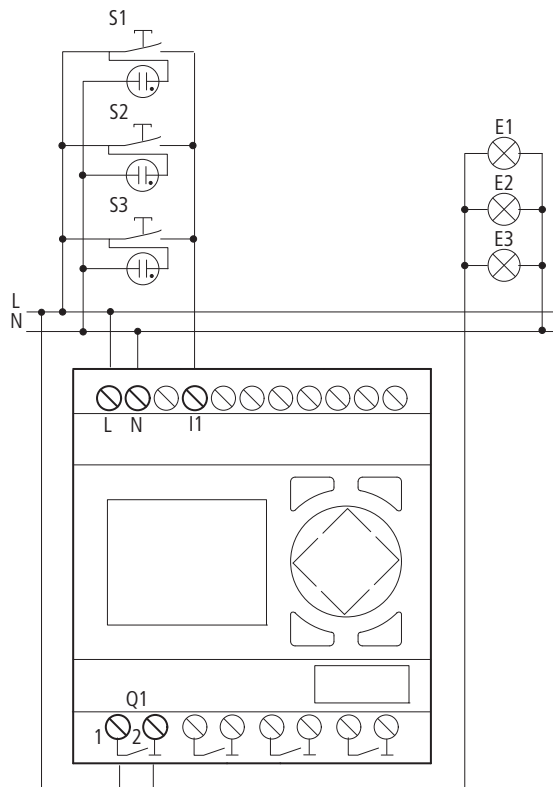

Figure 89: Stairwell lighting with easy

| | |
|----------------------------------|---|
| Button pressed briefly | Light ON or OFF. The impulse relay function will even switch off Continuous lighting. Light off after 6 min. with Continuous lighting this function is not active. |
| Button pressed for more than 5 s | continuous light |

4 Wiring easy with

4.15 Circuit examples

The easy circuit diagram for the functions described above looks like this:

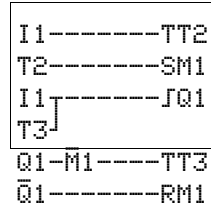

The enhanced easy circuit diagram: after four hours, the continuous lighting is also switched off.

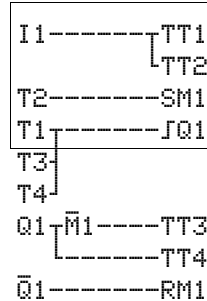

Figure 90: easy circuit diagram stairwell lighting

Meaning of the contacts and relays used:

- I1: ON/OFF pushbutton
- Q1: Output relay for light ON/OFF
- M1: Marker relay. This is used to block the "switch off automatically after 6 minutes" function for continuous lighting.
- T1 Cycle pulse for switching Q1 on and off, (□, single-pulse with value 00.00 s)
- T2 Scan to determine how long the button was pressed. If pressed longer than 5 s, continuous lighting is switched on (x, on-delayed, value 5 s).
- T3 switch off after a lighting time of 6 min. (x, on-delayed, value 6:00 min).
- T4 Switch off after 4 hours continuous lighting (x, on-delayed, value 4:00 h).

If you are using a control relay with a time switch, you can define both the stairwell lighting and the continuous lighting periods via the time switch. If you use a control relay with analog inputs, you can optimize the stairwell lighting with a brightness sensor to suit the lighting conditions.

5 easysettings

All easy settings carried out on the device require the use of the button field and display. Alternatively, you can carry out all easy settings with the easySoft programming software.

5.1 Password protection

The easy can be protected by a password against unauthorized access.

In this case the password consists of a value between 0001 and 9999. You can use the number combination 0000 to delete a password.



Default settings:
0000, no password present and none active, circuit diagram area selected.

Password protection inhibits access to selected areas. The System menu is always protected when a password is activated.

The password can protect the following entries and areas:

- Start or modification of the program
- Transfer of a circuit diagram to or from a memory card (Display variants).
- the transfer of a circuit diagram from and to the memory card
- Change of the RUN or STOP mode.
- Calling and modification of function block parameters.
- All settings of the real-time clock.
- Modifications of all system parameters.
- Communication with the individual device.
- Disabling of the password delete function.



A password that has been entered in easy is transferred to the memory card together with the circuit diagram, irrespective of whether it was activated or not.

If this easy circuit diagram is loaded back from the memory card, the password will also be transferred to easy and is activated immediately.

5.1.1 Password setup

A password can be set up via the System menu in either RUN or STOP mode. You cannot change to the System menu if a password is already activated.

- ▶ Press **DEL** and **ALT** to call up the System menu.
- ▶ Select the menu option SECURITY... to enter the password.
- ▶ Press the **OK** button and move to the PASSWORD... menu.
- ▶ Press **OK** again to enter the Password entry mode.



If no password has been entered, easy changes directly to the password display and displays for XXXX characters: No password present.

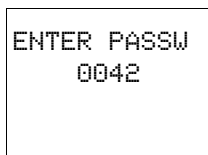

- ▶ Press **OK**, four zeros will appear
- ▶ Set the password using the cursor buttons:
 - < > select position in the password,
 - ^ v Select a value between 0 and 9.
- ▶ Save the new password by pressing **OK**.

Use **OK** to exit the password display and proceed with **ESC** and v to the RANGE... menu.

The scope of the password has not yet been defined. The password is now valid but not yet activated.

5.1.2 Selecting the scope of the password

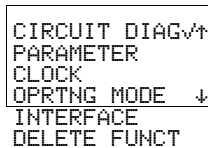

- ▶ Press the **OK** button.
- ▶ Select the function or the menu to be protected.
- ▶ Press the **OK** button in order to protect the function or menu (tick = protected).



Standard protection encompasses the programs and circuit diagram.

At least one function or menu must be protected.

- CIRCUIT DIAG: The password is effective on the program with circuit diagram and non-enabled function relays.
- PARAMETER: The PARAMETER menu is protected.
- CLOCK: Date and time are protected with the password.
- OPERATING MODE: The toggling of the RUN or STOP operating mode is protected.
- INTERFACE: The interface is blocked for access with easySoft (-Basic, -Pro).
- DELETE FUNCT: The question DELETE PROG? will appear on the device after four incorrect password entries have been made. This prompt is not displayed if selected. However, it is no longer possible to make changes in protected areas if you forget the password.

5.1.3 Activating Passwords

You can activate a valid password in three different ways:

- automatically when easy is switched on again
- automatically after a protected circuit diagram is loaded
- via the password menu

- ▶ Press **DEL** and **ALT** to call up the System menu.
- ▶ Open the password menu via the SECURITY... menu

easy will only show this menu if a password is present.

```
CHANGE PW
ACTIVATE
```



Make a notes of the password before activating it. If the password is no longer known, easy can be unlocked (DELETE FUNCT is not active), but the circuit diagram and data settings are lost. The interface must not be disabled.

CAUTION

If the password is unknown or lost, and the password delete function is not activated: The unit can only be reset to the factory setting by the manufacturer. The program and all data will be lost.

- ▶ Select ACTIVATE PW and press **OK**.

The password is now active. easy changes back automatically to the Status display.

You must unlock easy with the password before you carry out a protected function, enter a protected menu or the System menu.

5.1.4 easy unlocking

Unlocking easy will deactivate the password. You can reactivate password protection later via the Password menu or by switching the power supply off and on again.

- ▶ Press **OK** to switch to the main menu.

The PASSWORD... entry will flash.

- ▶ Press **OK** to enter the password entry menu.

```
PASSWORD...
STOP RUN ✓
PASSWORD...
INFO
```



If easy shows PROGRAM... in the main menu instead of PASSWORD..., this means that there is no password protection active.

5 easysettings

5.1 Password protection

```
ENTER PASSW
XXXX
```

easy will display the password entry field.

- ▶ Set the password using the cursor buttons:
- ▶ Confirm with **OK**.

If the password is correct, easy will switch automatically to the Status display.

```
PROGRAM...
STOP
PARAMETER
INFO
```

The PROGRAM... menu option is now accessible so that you can edit your circuit diagram.

The System menu is also accessible.

5.1.5 Changing or deleting the password range

- ▶ Unlock easy.
- ▶ Press **DEL** and **ALT** to call up the System menu.
- ▶ Open the password menu via the menu option SECURITY → PASSWORD...

```
CHANGE PW
ACTIVATE PW
```

The CHANGE PW entry flashes.

easy will only show this menu if a password is present.

```
ENTER PASSW
XXXX
```

- ▶ Press **OK** to enter the password entry menu.
- ▶ Press **OK** to move to the 4-digit entry field.
- ▶ Four zeros will be displayed

```
ENTER PASSW
1789
```

- ▶ Modify the four password digits using the cursor buttons.
- ▶ Confirm with **OK**.

Press **ESC** to exit the security area.

```
ENTER PASSW
0000
```

5.1.5.1 Delete

Use number combination 0000 to delete a password.

If a password has not been entered already, easy will show four XXXX.

5.1.6 Password incorrect or no longer known

If you no longer know the exact password, you can try to re-enter the password several times.



The DELETE FUNCT function has not been deactivated.

```
ENTER PASSW
XXXX
```

Have you entered an incorrect password?

- ▶ Re-enter the password.

```
DELETE ?
```

After the fourth entry attempt easy will ask whether you wish to delete the circuit diagram and data.

- ▶ Press
 - **ESC**: Circuit diagram, data or password are not deleted.
 - **OK**: Circuit diagram, data and password are deleted.

easy will return to the Status display.



If you no longer know the exact password, you can press **OK** to unlock the protected easy. The saved circuit diagram and all function relay parameters will be lost.

Pressing **ESC** will retain the circuit diagram and data. You can then make another four attempts to enter the password.

5.2 Changing the menu language

easy500 and easy700 provide twelve menu languages which are set as required via the System menu.

| Language | Display |
|------------|------------|
| English | ENGLISH |
| Deutsch | DEUTSCH |
| French | FRANCAIS |
| Spanish | ESPAÑOL |
| Italian | ITALIANO |
| Portuguese | PORTUGUES |
| Dutch | NEDERLANDS |
| Swedish | SUENSKA |
| Polish | POLSKI |
| Turkish | TURKCE |
| Czech | CESKY |
| Hungarian | MAGYAR |



Language selection is only possible if easy is not password-protected.

5 easysettings

5.3 Alter parameters

```
ENGLISH  ↑
DEUTSCH  ✓
FRANCAIS
ESPANOL  ↓
ITALIANO
PORTUGUES
NEDERLANDS
SUENSKA
POLSKI
TURKCE
CESKY
MAGYAR
```

```
SICUREZZA
SISTEMA...
LINGUA MENU
CONFIGURA...
```

- ▶ Press **DEL** and **ALT** to call up the System menu.
- ▶ Select LANGUAGE... to change the menu language.

The language selection for the first entry ENGLISH is displayed.

- ▶ Use ^ or v to select the new menu language, e.g. Italian (ITALIANO).
- ▶ Confirm with **OK**. ITALIANO is assigned a tick.
- ▶ Exit the menu with **ESC**.

easy will now show the new menu language.

Press **ESC** to return to the Status display.

5.3 Alter parameters

easy allows you to change function relay parameters such as timing relay setpoint values and counter setpoints without having to call up the circuit diagram. This is possible regardless of whether easy is running a program or is in STOP mode.

- ▶ Press **OK** to switch to the main menu.
- ▶ Start the parameter display by selecting PARAMETER.

```
T3  11  S  +
T8  X   M:S +
C4  N   +
O3                   +
O2                   +
A1  EQ  +
A3  LT  +
```

All function relays are displayed as a list.

The following preconditions must be fulfilled in order for a parameter set to be displayed:

- A function relay must have been included in the circuit diagram.
- The PARAMETER menu must be available.
- The parameter set must have been enabled for access, indicated by the + character at the bottom right of the display.



You can enable or disable parameter access using the "+" or "-" parameter set characters in the circuit diagram.

```
T3 U S +
I1 02,030
I2 05,000
T:
```

- ▶ Select the required function block with \wedge or \vee .
- ▶ Press the **OK** button.
- ▶ Use the cursor buttons \wedge or \vee to scroll through the parameters.
- ▶ Change the values for a parameter set:
 - Press **OK** to enter the Entry mode,
 - Press $\langle \rangle$ to change decimal place,
 - Press $\wedge\vee$ to change the value of a decimal place,
 - Press **OK** to save constants or
 - **ESC** Retain previous setting.

Press **ESC** to leave the parameter display.

5.3.1 Adjustable parameters for function relays

You can also modify the function relay parameters used in the circuit diagram in the PARAMETER menu.

Adjustable setpoint values are:

- With all function relays the setpoints
- On and off times with time switches.

In RUN mode easy operates with a new setpoint as soon as it has been modified in the parameter display and saved with **OK**.

5.3.1.1 Example: Changing switch times for outdoor lighting

The outdoor lighting of a building is automatically switched on from 19:00 to 23:30 Mondays to Fridays in the easy circuit diagram.

```
01 A 15:21 +
D MO-FR
ON 19:00
OFF 23:30
```

The parameter set for the time switch function relay 1 is saved in channel A and looks like this.

From the following weekend, the outdoor lighting is now also required to switch on between 19:00 and 22:00 on Saturdays.

- ▶ Select PARAMETER from the main menu.

The first parameter set is displayed.

- ▶ Use \wedge or \vee to scroll through the parameter sets until channel A of time switch 1 is displayed.
- ▶ Press \wedge to select the next empty parameter set, in this case channel B of time switch 1.

```
01 B 15:21 +
D --
ON 00:00
OFF 00:00
```

The current time is 15:21.

- ▶ Change the value for the day interval from MO to SA:
 - $\langle \rangle$ Move between the parameters
 - $\wedge\vee$ Change value.
- ▶ Press **OK** to acknowledge the value SA.

```
01 B 15:21 +
D SA
ON 00:00
OFF 00:00
```

5 easysettings

5.4 Setting date and time

```
01 B 15:21 +
D   SA
ON  19:00
OFF 00:00
```

- ▶ Change the ON value to 19:00.
- ▶ Move to the value of ON
- ▶ Press **OK**
 - <> Move between the parameters
 - ^\ Change value.
- ▶ Press **OK** to acknowledge the value 19:00.

```
01 B 15:21 +
D   SA
ON  19:00
OFF 22:00
```

- ▶ Set the switching off time to 22:00.
- ▶ Press **OK**.

easy will save the new parameters. The cursor will remain in the contact field on channel identifier B.

Press **ESC** to leave the parameter display.

The time switch will now also switch on at 19:00 on Saturdays and switch off at 22:00.

5.4 Setting date and time

The easy500 and easy700 devices are equipped with a real-time clock with date and time functions. The type reference is EASY...-...-**C**. The time switch function relays can thus be used to implement time switch applications.



Default settings:
"SA 0:01 01.05.2004"

5.4.1 Set time

If the clock is not set or easy is switched on after the battery back-up time has elapsed, the clock starts with the setting "SA 0:01 01.05.2004" The easy clock operates with date and time so that hour, minute, day, month and year have to be set.

- ▶ Select SET CLOCK... from the main menu.

This will open the menu for setting the time.

- ▶ Select SET CLOCK and confirm with **OK**.

```
SET CLOCK
SUMMER TIME
```

```
HH:MM: 18:24
DD.MM 01.05
YEAR : 2004
```

- ▶ Set the values for time, day, month and year.
- ▶ Press the **OK** button to access the Entry mode.
 - <> Select the position.
 - ^\ Change the value of a parameter
 - **OK** Save day and time.
 - **ESC** Retain previous setting.

Press **ESC** to leave the time setting display.

5.4.2 Setting summer time start and end

Most easy models are fitted with a real-time clock. The clock has various possibilities for starting and ending the summer time (DST) setting. These are subject to different legal requirements in the EU, GB and USA.

➔ Default settings:
No automatic DST setting present

You can make the following settings:

- NONE: no DST setting rule.
- RULE...: User-defined date of DST change.
- EU: date defined by the European Union;
Start: last Sunday in March;
End: last Sunday in October.
- GB: Select the EU option for the statutory DST setting for the UK.
Date for the United Kingdom as per the obsolete rule that is stored in the device;
Start: Last Sunday in March;
End: Fourth Sunday in October.
After the statutory settings have changed, the above rules for the European Union will also apply to the United Kingdom.
- US: Set the beginning and the end of the daylight savings time via the **Rule...** menu or in easySoft choose the supplied rule **New North America DST** for the currently applicable DST setting.
Start: Second Sunday in March at 2:00 a.m. local time; End: First Sunday in November at 2:00 a.m. local time.
Date for the USA as per the obsolete rule stored in the device;
Start: First Sunday in April;
End: Last Sunday in October

The following applies to all legally stipulated DST settings:

- Summer time start: On the day of time change, the clock moves forward one hour at 2:00 to 3:00.
- Summer time end: On the day of time change, the clock moves back one hour at 3:00 to 2:00.

Select SET CLOCK... from the main menu.

This will open the menu for setting the time.

- ▶ Select the SUMMER TIME menu option.

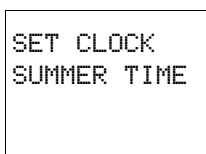

5.4.3 Setting summer time start and end

easy shows you the options for the DST change.

The standard setting is NONE for automatic DST changeover (Tick at NONE).



The start and end of summer time can only be set in STOP mode.

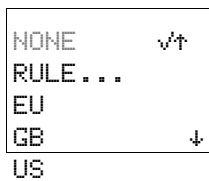

► Select the required variant and press the **OK** button.

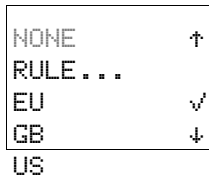

The rule for the European Union (EU) has been selected.

5.4.4 Summer time start and end, setting the rule

To set your own date. It is important to know what settings are possible.

The start and end of summer time is a complex calculation procedure throughout the world. For this reason, the standard rules for the EU, US, GB are provided in easy.

The following rules normally apply:

Table 29: DST setting rule

| When | Day of week | How | Date |
|---|---|-------|---------------|
| AM | WD | | |
| Rule 1: change on a special date | | | |
| -- | -- | -- | → Table 30: |
| Rule 2: change on a defined day in the month | | | |
| <ul style="list-style-type: none"> • 1st (first) • 2nd (second) • 3rd (third) • 4th (fourth) • L. (last) | <ul style="list-style-type: none"> • SU (Sunday) • MO (Monday) • TU (Tuesday) • WE (Wednesday) • TH (Thursday) • FR (Friday) • SA (Saturday) | MONTH | → Table 30:1) |

| When | Day of week | How | Date |
|------|-------------|-----|------|
| AM | WD | | |

Rule 3: change on a defined day after or before a date

| | | | |
|-------------|---|---|-------------|
| 1st (first) | <ul style="list-style-type: none"> • SU (Sunday) • MO (Monday) • TU (Tuesday) • WE (Wednesday) • TH (Thursday) • FR (Friday) • SA (Saturday) | <ul style="list-style-type: none"> • AFTER THE • BEFORE THE | → Table 30: |
|-------------|---|---|-------------|

1) Apart from day definitions

Table 30: Date parameters

| Day | Month | Hour | Minute | Time difference |
|-------|-----------------|-------|--------|-----------------|
| DD. | MM | HH: | MM | H:M |
| • 1. | • 1 (January) | • 00 | • 00 | • +3:00 |
| • 2. | • 2 (February) | • 01 | • 01 | • +2:30 |
| • ... | • ... | • 02 | • 02 | • +2:00 |
| • 31. | • 12 (December) | • 03 | • 03 | • +1:30 |
| | | • ... | • 04 | • +1:00 |
| | | • 23 | • ... | • +00:30 |
| | | | • 59 | • -00:30 |
| | | | | • -1:00 |
| | | | | • -1:30 |
| | | | | • -2:00 |
| | | | | • -2:30 |
| | | | | • -3:00 |

5.4.4.1 Example with EU (European Union)

End of summer time

Menu in easy SUMMER END

The following rule applies:

The clock goes back one hour (-1:00) to 2:00 at 3:00 on the last Sunday in October.

Table 31: EU Summer time end

| When | Day of week | How | Day | Month | Hour | Minute | Time difference |
|-----------------|-------------|-------|-----|--------------|------|--------|-----------------|
| | WD | | DD. | MM | HH: | MM | H:M |
| AM L. (last) | SU (Sunday) | MONTH | -- | 10 (October) | 03 | 00 | - 1:00 |

5 easysettings

5.4 Setting date and time

5.4.4.2 Start of summer time

Menu in easy SUMMER START

The following rule applies:

The clock goes forward one hour (+1:00) to 3:00 at 2:00 on the last Sunday in March.

Table 32: EU Start of summer time

| When | Day of week | How | Day | Month | Hour | Minute | Time difference |
|-----------------|-------------|-------|-----|------------|------|--------|-----------------|
| | WD | | DD. | MM | HH: | MM | H:M |
| AM L. (last) | SU (Sunday) | MONTH | -- | 03 (March) | 02 | 00 | + 1:00 |



If your easy is to be operated in other countries or regions of the globe, refer to the latest legal requirements for DST on the Internet. Use search terms like "time change", "Daylight Saving Time" or "DST" to find tables with the dates and times of national DST settings.

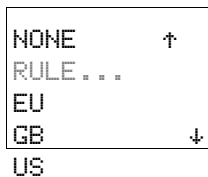

- ▶ Select the RULE menu.
- ▶ Press the **OK** button.

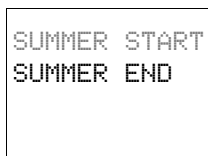

The two SUMMER START (start of summer time) and SUMMER END (end of summer time) menus are shown.

SUMMER START: set the DST time for the start of summer.

SUMMER END: set the DST time for the end of summer.



If a standard rule has been selected, this will be accepted as the rule.

This menu appears for entering the required time settings:

| | | |
|-------------|-------|--|
| AM | L.↑ | — Rule for day, 1st, 2nd, 3rd, 4th, Lst. |
| WD: | SU | — Day of week |
| | MONTH | — Rule 2 MONTH, AFTER, BEFORE |
| TT.MM:-- | .03↓ | — Date, day, month |
| HH:MM:02:00 | | — Time, hour, minute |
| DIFF: +1:00 | | — Time difference, summer time always + x:xx Time difference, winter time always - x:xx |

5.4.4.3 Enter summer time start.

```
SUMMER START
SUMMER END
```

- ▶ Press **OK** to reach Entry mode for the summer time start rule.

The following menu appears:

```
AM          L.↑
WD:         SU
            MONTH
TT,MM:--.03↓
HH:MM:02:00
DIFF: +1:00
```

This will open the menu for setting the time.

- ▶ Set the values for DST time change.
- ▶ Press the **OK** button to access the Entry mode.
 - ^v Select required value.
 - <> Select the position.
 - ^v Change the value of a parameter
 - **OK** Save value.
 - **ESC** Retain previous setting.

Press **ESC** to leave the DST setting display.

The above rule is the EU rule for the start of summer time.

➔ The menu for the end of summer time has the same structure. The values are now entered accordingly.

➔ The DIFF time difference value can be modified both for the summer time setting and the winter time setting. The value is always the same.
Summer time means a positive value + X:XX.
Winter time means a negative value – X:XX.

➔ Behavior on 29 February
If the time change is set for 29.02. at HH.MM, the switch time for years that are not leap years will occur on 01.03 at HH.MM. The DST time minus the time difference should not go into 28.02. The following applies:
00:15 is put back by –30 min. New time: 28.02. 23:45

➔ Behavior for summer time end on 01.01.
If 01.01. is selected for the end of summer time, ensure the following:
The DST time minus the time difference should not go into 31.12. Otherwise the time will continue to run until the set time minus the time difference 00:00 on the 01.01. The time will then continue to run with 00:00.

5 easysettings

5.5 Activating input delay (debounce)



Setting the time manually within the summer time end setting:
At 3:00 on summer time end the time is to be put back by one hour to 2:00.

The clock is set at 1:30 to 3:05. easy will interpret this as 3:05 winter time. A time change will not be carried out.

5.5 Activating input delay (debounce)

Input signals are evaluated by easy with an input delay. This enables, for example, the trouble-free evaluation of switches and pushbutton actuators subject to contact bounce.



Default settings:
Debounce is activated.

High-speed counter functions are evaluated independently of the debounce function.

However, for many applications, it is necessary to evaluate very short input signals. In this case, the debounce function can be switched off.

- ▶ Press **DEL** and **ALT** to call up the System menu.
- ▶ Select the SYSTEM menu.



If easy is password-protected you cannot open the System menu until you have "unlocked" it.

```
DEBOUNCE .  ↑
P BUTTONS
RUN MODE
CARD MODE  ↓
```

The input delay (debounce) is set with the DEBOUNCE menu item.

5.5.1 Activating debounce (input delay)

```
DEBOUNCE  ✓↑
P BUTTONS
RUN MODE
CARD MODE  ↓
```

If a tick ✓ is next to DEBOUNCE indicates that this function is activated.

If this is not so, proceed as follows:

- ▶ Select DEBOUNCE and press **OK**.

Debounce mode will be activated and the display will show DEBOUNCE ✓.

Press **ESC** to return to the Status display.

5.5.2 Deactivating debounce (input delay)

If easy is showing `DEBOUNCE` in the display, this means that Debounce mode has already been deactivated.

- ▶ Otherwise select `DEBOUNCE` ✓ and press **OK**.

If Debounce mode is deactivated the display will show `DEBOUNCE`.



How easy input and output signals are processed internally is explained in (→ Section "6.2 Delay times for inputs and outputs", from page 189).

5.6 Activating and deactivating the P buttons

Even though the cursor buttons (P buttons) have been set as pushbutton actuator inputs in the circuit diagram, this function is not activated automatically. This prevents any unauthorized use of the cursor buttons. The P buttons can be activated in the System menu.



If easy is password-protected you cannot open the System menu until you have "unlocked" it.



Default settings:
The P buttons are not activated.

The P buttons are activated and deactivated via the P BUTTONS menu.

```
DEBOUNCE  ✓↑
P BUTTONS
RUN MODE
CARD MODE  ↓
```

- ▶ Press **DEL** and **ALT** to call up the System menu.
- ▶ Select the SYSTEM menu.
- ▶ Move the cursor to the P BUTTONS menu.

5.6.1 Activating P buttons

```
DEBOUNCE  ✓↑
P BUTTONS  ✓
RUN MODE
CARD MODE  ↓
```

If easy is displaying `P BUTTONS` ✓, this means that the P buttons are active.

- ▶ Otherwise select `P BUTTONS` and press **OK**.

easy changes the display to `P BUTTONS` ✓ and the P buttons are activated.

- ▶ Return to the status display using **ESC**.

5.6.2 Function of the P buttons

The P buttons are only active in the Status display. In this display you can use the P buttons to activate inputs in your circuit diagram.



If a text is displayed, the P buttons only function if a value entry is not carried out.

5.6.3 Deactivating the P buttons

- ▶ Select P BUTTONS \checkmark and press **OK**.

easy changes the display to P BUTTONS and the P buttons are deactivated.



If you delete a circuit diagram in easy, the P buttons are automatically deactivated. If all circuit diagrams are loaded from the memory card or easySoft, the set state is transferred.

5.7 Startup behavior

The startup behavior is an important aid during the commissioning phase. The circuit diagram which easy contains is not yet fully wired up, or the system or machine is in a state which easy is not permitted to control. The outputs should not be controlled when easy is switched on.

5.7.1 Setting the startup behavior



The easy models without a display can only be started in RUN mode.

Requirement: easy must contain a valid circuit diagram.



Default settings:
RUN mode is activated.

Switch to the system menu.



If easy is password-protected, the System menu can only be accessed after easy has first been "unlocked" (→ Section "5.1.4 easy unlocking", from page 165).

Specify the operating mode which easy must use when the power supply is switched on.

5.7.1.1 Activating RUN mode

```

DEBOUNCE  √↑
P BUTTONS
RUN MODE  √
CARD MODE  ↓
    
```

If easy is displaying RUN MODE √, easy switches to RUN mode when the power supply is switched on.

▶ Otherwise select RUN MODE and press **OK**.

RUN mode is activated.

▶ Return to the status display using **ESC**.

5.7.1.2 Deactivating RUN mode

```

DEBOUNCE  √↑
P BUTTONS
RUN MODE  √
CARD MODE  ↓
    
```

▶ Select RUN MODE √ and press **OK**.

The RUN mode function is deactivated.

The default setting for easy is for RUN MODE √ to be displayed. In other words, easy starts in RUN mode when the power is switched on.

Table 33: Startup behavior

| Startup behavior | Menu displayed | Status of easy after startup |
|--------------------------|----------------|------------------------------|
| easy starts in STOP mode | RUN MODE | easy is in STOP mode |
| easy starts in RUN mode | RUN MODE √ | easy is in RUN mode |

5.7.2 Behavior when the circuit diagram is deleted

The setting for the startup behavior is an easy device function. When the circuit diagram is deleted this does not result in the loss of the setting selected.

5.7.3 Behavior during upload/download to card or PC

When a valid circuit diagram is transferred from easy to a memory card or the PC or vice versa, the setting is still retained.



The easy models without a display can only be started in RUN mode.

5.7.4 Possible Faults

easy will not start in RUN mode:

- easy does not contain a program.
- You have put easy in STOP mode (RUN MODE menu).

5.7.5 Card startup behavior

The startup behavior using a memory card is for applications where unskilled personnel have to change the memory card with easy de-energized.

easy only starts in the RUN mode if a memory card with a valid program is inserted.

If the program on the memory card is different to the program in easy, the program from the card is loaded into easy and easy starts in RUN mode.



Default settings:
Card mode is not activated.

- ▶ Switch to the system menu.



If easy is password-protected, the System menu can only be accessed after easy has first been "unlocked" (→ Section "5.1.4 easy unlocking", from page 165).

5.7.5.1 Activation of card mode

If easy shows `CARD MODE √`, easy only switches to RUN mode on power up if a memory card with a valid program is fitted.

```
DEBOUNCE  √↑
P BUTTONS
RUN MODE  √
CARD MODE √↓
```

- ▶ Otherwise select `CARD MODE` and press **OK**.

easy will start up with the program on the card.

- ▶ Return to the status display using **ESC**.



Card mode only functions with the EASY-M-32K memory card. Previous EASY-M-8K or EASY-M-16K memory cards did not support this function.

5.7.5.2 Deactivating card mode

```
DEBOUNCE  √↑
P BUTTONS
RUN MODE  √
CARD MODE ↓
```

- ▶ Select `CARD MODE √` and press **OK**.

The Card mode function is deactivated.

The default setting is for display of easy the `CARD MODE` menu, i.e. easy starts in RUN mode without the memory card when the power is switched on.

5.8 Setting the cycle time

easy allows you to fix the cycle time. To do this, move to the SYSTEM menu and from there to the CYCLE TIME... menu.

➔ Default settings:
The cycle time is set to 00 ms.

```
P BUTTONS  ↑
RUN MODE   ✓
CARD MODE  ✓
CYCLE-T... ↓
```

The cycle time can only be set in STOP mode.

easy is in STOP mode.

▶ Select CYCLE-T and press **OK**.

The following menu appears:

```
CYCLE TIME
  00 MS
```

▶ Press **OK**.

You can now enter the set cycle time.

- < > Move between the parameters.
- ^ v Change value.

▶ Press **OK** to acknowledge the value: e.g. 35 ms.

```
CYCLE TIME
  35 MS
```

The set cycle time is at least 35 ms. The cycle time can be longer if easy requires more time for processing the program.

➔ The entry of a set cycle time is only useful in applications involving two-step controllers or similar functions. With a cycle time setting of 00 ms, easy will process the circuit diagram and the program at the fastest possible speed. (see also inside easy... cycle time)

Set cycle time value range:

between 00 and 60 ms.

5.9 Retention (non-volatile data storage)

Plant and machine controls require the possibility to retentively set operating states or actual values, i.e. the values should be retained safely even after the power supply of a machine or plant has been switched off and should be left unchanged until the actual value is overwritten.

➔ Default settings:
The retention function is not activated.

5.9.1 Permissible markers and function relays

It is possible to retentively store (non-volatile memory) the actual values (status) of markers, timing relays and up/down counters.

The following markers and function relays can be set to have retentive actual values:

- Markers: M9 to M12, M13 to M16, N9 to N16
- Up/down counters: C5 to C7, C8, C13 to C16
- Text function relays: D1 to D8
- Timing relays: T7, T8, T13 to T16



To ensure that easy500 and easy700 are fully compatible with easy400 and easy600 devices, the retentive data settings were divided into the above areas.

CAUTION

The retentive data is kept every time the power supply is switched off. Data security is assured for 1 000 000 write cycles.

5.9.2 Setting retentive behavior

Requirement: The easy500/700 control relay must be in **STOP** mode.

- ▶ Switch to the system menu.



If easy is password-protected, the System menu can only be accessed after easy has first been "unlocked" (→ Section "5.1.4 easy unlocking", page 165from).

```

RUN MODE  √↑
CARD MODE
CYCLE-T...
RETENTION..↓
    
```

- ▶ Switch to STOP mode.
- ▶ Switch to the system menu.
- ▶ Move to the SYSTEM menu and continue to the RETENTION... menu.
- ▶ Press the **OK** button.

```

M 9 - M12 √↑
M13 - M16
N 9 - N16
C 5 - C 7 √↓
C 8          √
C13 - C16
D 1 - D 8
T7
T8
T13 - T16
    
```

The first screen display is the selection of the marker range.

- ▶ ^~ Select a range.
- ▶ Press **OK** to select the marker, the function relay or the range that is to be retentive (tick on the line).

Press **ESC** to exit the input for the retentive ranges.

| | |
|-----------|---|
| M 9 - M12 | √ |
| M13 - M16 | |
| N 9 - N16 | |
| C 5 - C 7 | √ |
| C 8 | √ |
| C13 - C16 | |
| D 1 - D 8 | |
| T 7 | √ |
| T 8 | √ |
| T13 - T16 | |

Example:

M9 to M12, counters C5 to C7, C8 as well as timing relays T7 and T8 are retentive. Indicated by the tick on the line. Indicated by the tick on the line.

The default setting of easy is selected so that no retentive data is selected. In this setting, easy works without retentive actual values if a valid circuit diagram is present. When easy is in STOP mode or has been switched to a de-energized state, all actual values are cleared.

5.9.3 Deleting retentive actual values

Requirement: The easy500/700 control relay is must be in **STOP** mode.

The retentive actual values are cleared, i.e. reset to 0 if:

- a new program is transferred **without** an activated retentive range from the easySoft or memory card to the control relay.
This also applies if there is no program on the memory card (in this case the old program is retained in the control relay).
- the selected retention of a marker, function relay or the text display is switched off in the System menu SYSTEM, RETENTION... of the control relay.
- the program is deleted in the main menu of the control relay via PROGRAM..., DELETE PROG.
- the marker range M1 to M16 is cleared of its retentive actual values with the master reset function relay activated in mode Z2 or Z3.

The operating hours counters are always retentive. The actual values can only be reset by means of a special reset operation from the circuit diagram.

The retentive actual values are retained if:

- a new program **with** an activated retentive range is loaded from easySoft or the memory card to the control relay.
- the program in the control relay is deleted via easySoft.

5.9.4 Transferring retentive behavior

The setting for retentive behavior is a circuit diagram setting; in other words, the retention setting is on the memory and is transferred with the circuit diagram when uploading or downloading from the PC.

5.9.5 Changing the operating mode or the circuit diagram

When the operating mode is changed or the easy circuit diagram is modified, the retentive data is normally saved together with their actual values. The actual values of no longer used relays are not retained.

5 easysettings

5.9 Retention (non-volatile data storage)

5.9.5.1 Changing the operating mode

If you change from RUN to STOP and then back to RUN, the actual values of the retentive data will be retained.

5.9.5.2 Modifying the easycircuit diagram

If a modification is made to the easy circuit diagram, the actual values will be retained.

CAUTION

Even if the markers and function relays that were retentive are deleted from the circuit diagram, the retentive actual values remain when changing from STOP to RUN, and when switching the device off and on. Should these relays be used again in the circuit diagram, they will still have their former actual values.

5.9.6 Changing the startup behavior in the **SYSTEM** menu

The retentive actual values in easy will be retained irrespective of the RUN MODE or STOP MODE settings.

5.10 Displaying device information

Device information is provided for service tasks and for determining the capability of the device concerned.

This function is only available with easy devices featuring a display.

Exception:

- Terminal mode with MFD-CP4 (see AWB2528-1548).
- MFD-CP8-... (see AWB2528-1480).

Easy allows you to show the following device information:

- AC, AB (AC voltage) or DA, DC (DC voltage),
- T (transistor output) or R (relay output)
- C (clock provided)
- LCD (display provided)
- OS: 1.10.204 (operating system version)
- CRC: 25825 (Checksum of the operating system is only displayed in STOP mode).
- Program name if this was assigned in easySoft.

- ▶ Switch to the main menu.



The device information is always available. The password does not prevent access.

```
PROGRAM... ↑
STOP ✓ RUN
PARAMETERS..
INFO... ↓
SET CLOCK..
```

- ▶ Select the main menu.
- ▶ Select the INFO.. menu with the cursor button ∨.
- ▶ Press the **OK** button.

```
DC TC LCD
OS: 1.00.027
CRC: 02752
PROGRAM_0815
```

This will display all device information.

Press **ESC** to exit the display.

5 easysettings

5.10 Displaying device information

6 easy Internal

6.1 easy circuit diagram cycle

In conventional control systems, a relay or contactor control processes all the rungs in parallel. The speed with which a contactor switches in this case depends on the components used, and ranges from 15 to 40 ms for relay pick-up and drop-out.

With easy the circuit diagram is processed with a microprocessor that simulates the contacts and relays of the circuit concerned and thus processes all switching operations considerably faster. Depending on its size, the easy circuit diagram is processed cyclically every 2 to 40 ms.

During this time, easy passes through five segments in succession.

6.1.0.1 How easy evaluates the circuit diagram:

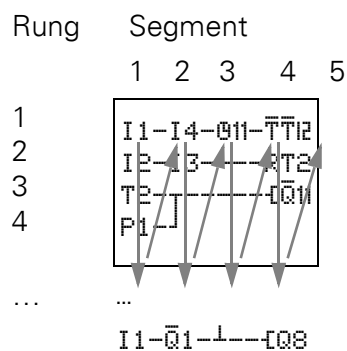

In the first three segments easy evaluates the contact fields in succession. As it does so, easy also checks whether the contacts are connected in parallel or series and stores the switching states of all the contact fields.

In the fourth segment, easy assigns the new switching states to all the coils in one pass.

The fifth segment is outside the circuit diagram and easy uses it to establish contact to the "outside world": The output relays Q1 to Q... are switched and inputs I1 to I... are read again. easy also copies all the new switching states to the status image register.

easy only uses this status image for one cycle. This ensures that each rung is evaluated with the same switching states for one cycle, even if the input signals at I1 to I12, for example, change their status several times within a cycle.

6 easy Internal

6.1 easy circuit diagram cycle

6.1.0.2 Evaluation in the circuit diagram and high-speed counter functions

When using high-speed counter functions, the signal state is continuously counted or measured irrespective of the processing of the circuit diagram. (C13, C14 high-speed up/down counters, C15, C16 frequency counters)

6.1.1 easyoperation and effects on circuit diagram creation

easy evaluates the circuit diagram in these five segments in succession. You should therefore remember two points when you create your circuit diagrams:

- The changeover of a relay coil does not change the switching state of an associated contact until the next cycle starts.
- Always wire forwards, upwards or downwards. Never wire backwards.

6.1.1.1 Example: switching in the next cycle

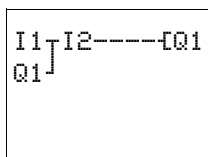

Start condition:

- I1, I2 switched on
- Q1 switched off.

This is the circuit diagram of a self-latching circuit. If I1 and I2 are closed, the switching state of relay coil Q1 is latched via contact Q1.

- **1st cycle:** Inputs I1 and I2 are switched on. Coil Q1 picks up.
- Contact Q1 remains switched off since easy evaluates from left to right.
- **2nd cycle:** The self-latching function now becomes active. easy has transferred the coil states to contact Q1 at the end of the first cycle.

6.1.1.2 Example: Do not wire backwards

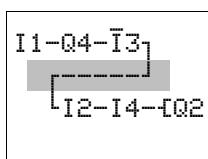

The following example shows why you should not wire backwards.

In the third rung, easy finds a connection to the second rung in which the first contact field is empty. The output relay is not switched.

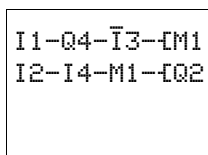

When wiring more than three contacts in series, use one of the marker relays.

6.2 Delay times for inputs and outputs

The time from reading the inputs and outputs to switching contacts in the circuit diagram can be set in easy via the delay time.

This function is useful, for example, in order to ensure a clean switching signal despite contact bounce.

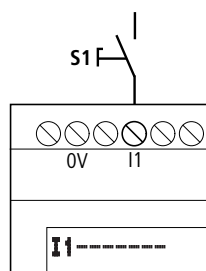

Figure 91: easy input assigned with a switch

easy-DC, easy-DA, easy-AB and easy-AC units function with different input voltages and therefore also have different evaluation characteristics and delay times.

6.2.1 Delay times with easy-DA and easy-DC basic units

The delay time for DC signals is 20 ms.

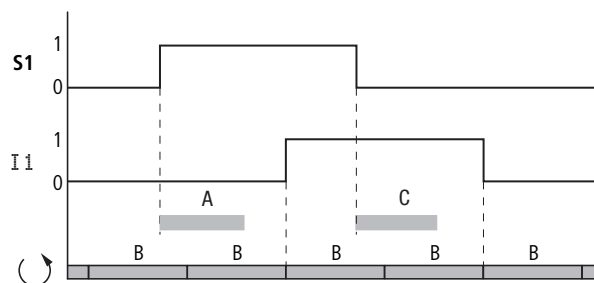

Figure 92: Delay times of easy-DC and easy-DA basic units

An input signal S1 must therefore be 15 V or 8 V (easy-DA) for at least 20 ms on the input terminal before the switch contact will change from "0" to "1" (range A). If applicable, this time must also include the cycle time (range B) since easy does not detect the signal until the start of a cycle.

The same time delay (range C) applies when the signal drops out from 1 to 0.

If the debounce is switched off, easy responds to an input signal after just 0.25 ms.

6 easy Internal

6.2 Delay times for inputs and outputs

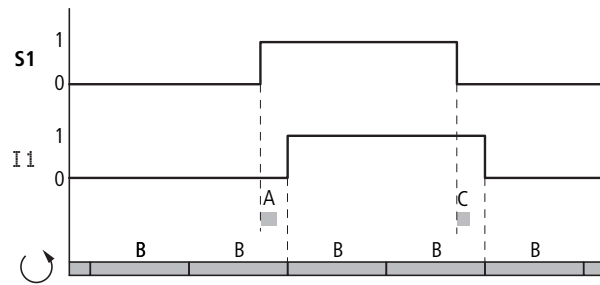

Figure 93: Switching behavior with input debounce disabled

Typical delay times with the debounce delay switched off are:

- On delay for I1 to I12
 - 0.25 ms (DC),
 - 0.3 ms (easy-DA)
- Off delay for
 - I1 to I6 and I9 to I12: 0.4 ms (easy-DC), 0.3 ms (easy-DA)
 - I7 and I8: 0.2 ms (DC), 0.35 ms (easy-DA)



Ensure clean input signals when the debounce is deactivated as easy reacts even to very short signals.

6.2.2 Delay time with easy-AB, easy-AC basic units

The input delay with AC voltage signals depends on the frequency. The appropriate values for 60 Hz are given in brackets:

- Switch-on delay
 - 80 ms at 50 Hz,
 - 66 ms at 60 Hz
- Off delay for
 - I1 to I6 and I9 to I12: 80 ms (66 ms)
 - I7 and I8: 160 ms (150 ms) with easy-AB
 - I7 and I8: 80 ms (66 ms) with easy-AC

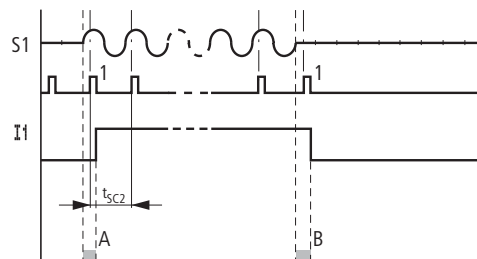

Figure 94: On delay for easy-AC, easy-AB

If the debounce is switched on, easy checks at 40 ms (33 ms) intervals whether there is a half-wave present at an input terminal (1st and 2nd pulses in A). If easy detects two pulses in succession, the device switches on the corresponding input internally.

If this is not the case, the input is switched off again as soon as easy does not detect two successive half-waves (1st and 2nd pulses in B).

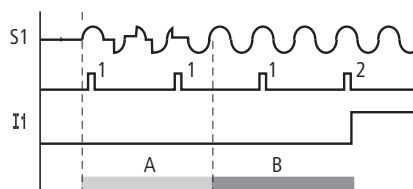

Figure 95: Pushbutton with bounce

If a button or switch bounces (A), the delay time may be extended by 40 ms (33 ms) (A).

If the debounce delay is switched off, the delay time is reduced:

- On delay
20 ms (16.6 ms)
- Off delay for
I1 to I6 and I9 to I12: 20 ms (16.6 ms)
- Off delay for
I7 and I8: 100 ms (100 ms) with easy-AB, easy-AC

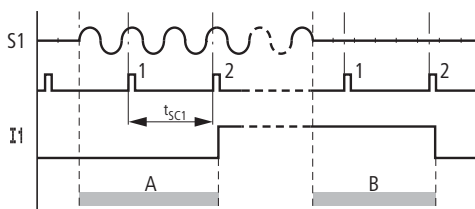

Figure 96: On and off delays

easy switches the contact as soon as it detects a pulse (A). If no pulse is detected, easy switches off the contact (B).



The procedure for changing the delay times is described in on (→ section "5.5 Activating input delay (debounce)", page 176).

6.2.3 Delay times for the analog inputs of easy-AB, easy-DA and easy-DC

The analog input values are read at 1 ms intervals. The values are continuously smoothed so that the analog values do not fluctuate excessively and remain clean. At the start of the circuit diagram cycle, the currently available analog values that have been smoothed are provided for processing in the circuit diagram.

6.3 Monitoring of the functionality of the basic unit

easy continuously checks its functionality by means of a system test and by means of various timeout watchdogs.

Table 34: Times of the timeout watchdogs

| Timeout Watchdog for monitoring | Specified Response time [s] |
|---|-----------------------------|
| Program processing | 1 |
| Program Download | 1 |
| Communication via the serial multi-function interface | 3 |

6.4 Monitoring of short-circuit/overload with EASY..-D.-T..

Depending on the type of easy in use, it is possible to use the internal inputs I15 and I16, R15, R16 to monitor for short-circuits or overloads on an output.

- EASY512-...-T...:
 - I16 = Group fault alarm for outputs Q1 to Q4.
- EASY721-...-T...:
 - I16 = Group fault alarm for outputs Q1 to Q4.
 - I15 = Group fault signal for outputs Q5 to Q8.
- EASY620-D.-TE:
 - R16 = Group fault alarm for outputs S1 to S4.
 - R15 = Group fault signal for outputs S5 to S8.

Table 35: Status of error outputs

| State of outputs | Status I15 or I16, R15 or R16 |
|--------------------------------------|--------------------------------|
| No fault present | 0 = switched off (N/O contact) |
| Fault present on at least one output | 1 = Switched on (N/O contact) |

The following examples are for I16 = Q1 to Q4. I15 indicates in the same way short-circuits and overloads on Q5 to Q8.

6.4.0.1 Example 1: Output with fault indication

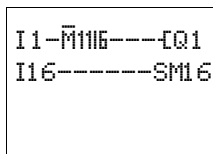

The circuit diagram functions as follows:

If a transistor output indicates a fault, M16 is set by I16. The N/C contact of M16 switches off the output Q1. M16 can be cleared by resetting the easy supply voltage.

6.4.0.2 Example 2: Output of operating state

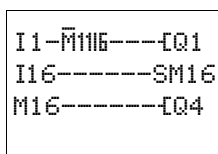

The circuit functions as described in Example 1. An additional feature is that when an overload is detected, the indicator light at Q4 is actuated. If Q4 has an overload, it would 'pulse'.

6.4.0.3 Example 3: Automatic reset of error signal

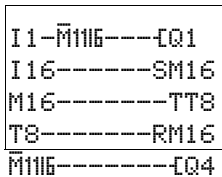

The circuit diagram functions in the same way as Example 2. In addition the marker M16 is reset every 60 seconds by timing relay T8 (on-delayed, 60 s). Should I16 remain at 1, M16 will continue to be set. Q1 is set briefly to 1 until I16 switches off again.

6.5 easy700 expanding

You can expand easy700 with EASY410-DC-.E, EASY618-..-RE, EASY202-RE or EASY620-D.-TE modules locally or use the EASY200-EASY coupling module for remote expansion.

For this first install the units and connect the inputs and outputs (→ Chapter 2 "Installation", page 25).

You process the inputs of the expansion devices as contacts in the easy circuit diagram in the same way as you process the inputs of the basic unit. The input contacts are assigned the operand identifiers R1 to R12.

R15 and R16 are the group fault alarms of the transistor expansion unit (→ Section "6.4 Monitoring of short-circuit/overload with EASY..-D.-T..", page 192).

The outputs are processed as relay coils or contacts in the same way as outputs in the basic unit. The output relays are called S1 to S8.

→ EASY410-DC-.E provides the outputs S1 to S4. The other outputs S5 - S8 can be used as markers. EASY618-..-RE provides the outputs S1 to S6. The other outputs S7, S8 can be used as markers.

The following bus modules can also be connected:

- EASY205-ASI (AS-Interface),
- EASY204-DP (Profibus DP),
- EASY221-CO (CAN open) or
- EASY222-DN (Device NET).

These modules offer considerably more functions than simple I/O expansion modules. Depending on type, all the data of the program can be read and setpoints can be written. The functions of the individual devices are described in the relevant documentation.

6.5.1 How is an expansion unit recognized?

easy checks cyclically whether a device is sending data via the easyLink interface.

6.5.2 Transfer behavior

The input and output data of the expansion units is transferred serially in both directions. Take into account the modified reaction times of the inputs and outputs of the expansion units:

6.5.2.1 Input and output reaction times of expansion units

The debounce setting has no effect on the expansion unit.

Transfer times for input and output signals:

- Central expansion
 - Time for inputs R1 to R12: 30 ms + 1 cycle time
 - Time for outputs S1 to S6 (S8): 15 ms + 1 cycle
- Remote expansion
 - Time for inputs R1 to R12: 80 ms + 1 cycle time
 - Time for outputs S1 to S6 (S8): 40 ms + 1 cycle

6.5.3 Function monitoring of expansion units

If the power supply of the expansion unit is not present, no connection can be established between it and basic unit. The expansion inputs R1 to R12, R15, R16 are incorrectly processed in the basic unit and show status 0. It cannot be assured that the outputs S1 to S8 are transferred to the expansion unit.



DANGER

Ensure the continuous monitoring of easy expansion devices in order to prevent switching faults in machines or systems.

The state of internal input I14 of the basic unit indicates the state of the expansion device:

- I14 = "0": expansion unit is functional
- I14 = "1": expansion unit is not functional



When the power supply is switched on, basic units and expansion devices may require different power up times to reach full functionality. If the basic device is powered up faster, the internal monitoring input I14 will have status I14 = "1", indicating that an expansion device is not functional.

Example

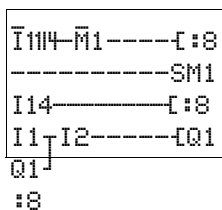

The expansion unit may be powered up later than the basic unit. This means that the basic unit is switched to RUN when an expansion unit is missing. The following easy circuit diagram detects if the expansion unit is functional or not functional.

As long as I14 is 1, the remaining circuit diagram is skipped. If I14 is 0, the circuit diagram is processed. If the expansion unit drops out for any reason, the circuit diagram is skipped. M1 detects whether the circuit diagram was processed for at least one cycle after the power supply is switched on. If the circuit diagram is skipped, all the outputs retain their previous state. The next example should be used if this is not desired.

Example with LCD output and reset of the outputs

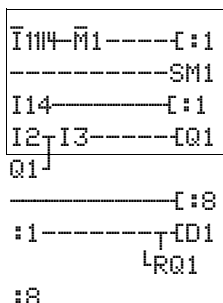

6.6 Saving and loading circuit diagrams

You can transfer circuit diagrams via the serial multi-function interface to a memory card or to a PC with the easySoft programming software and a programming cable.

6.6.1 EASY....-...X

Models without buttons can be loaded with the program via easySoft or automatically from the fitted memory card every time the power supply is switched on.

6.6.2 Interface

The serial multi-function interface is covered.

 **DANGER**

On easy AC devices there is a **danger** of electric shock if:

- L phase conductor and N neutral conductor are reversed,
- the 230 V/115 V supply voltage is present on the multi-function interface,
- if the plug is not properly connected or conductive objects are inserted in the shaft of the multi-function interface.

For your safety:

- Use the original programming cable, which ensures safe electrical isolation of the PC terminal from the connection voltage of the L phase conductor (100 to 240 V AC).
- Push the interface cover back onto the shaft when the interface is no longer required.

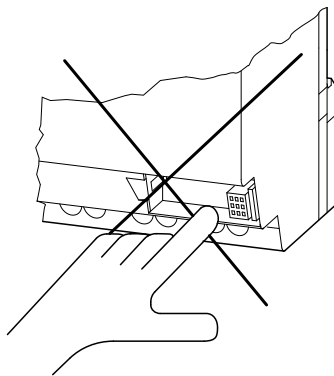

Figure 97: Do not touch the interface

- ▶ Carefully remove the interface cover with a screwdriver.

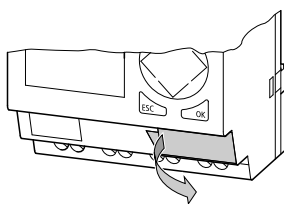

Figure 98: Remove interface cover

- ▶ Push the interface cover back onto the shaft after you have removed the programming cable.

6.7 Memory card

The card is available as an accessory EASY-M32K for easy500 and easy700.

6.7.1 Compatibility with EASY-M-8K, EASY-M-16K memory cards

Circuit diagrams with all the data can transferred to the easy500 and easy700 from the EASY-M-8K (easy412) and EASY-M16K (easy600) memory card. A transfer, however, in the other direction is not possible.

Each memory card can hold **one** easy circuit diagram.

Information stored on the memory card is “non-volatile” and thus you can use the card to archive, transfer and copy circuit diagrams.

On the memory card you can save:

- the circuit diagram
- all parameter sets of the function relays
- all display texts with functions
- the system settings,
 - Input delay
 - P Buttons
 - Password
 - retention on/off,
- Card Start
- summer time start/end time settings

► Insert the memory card in the open interface slot.

easy500 (EASY-M-32K): easy700 (EASY-M-32K):

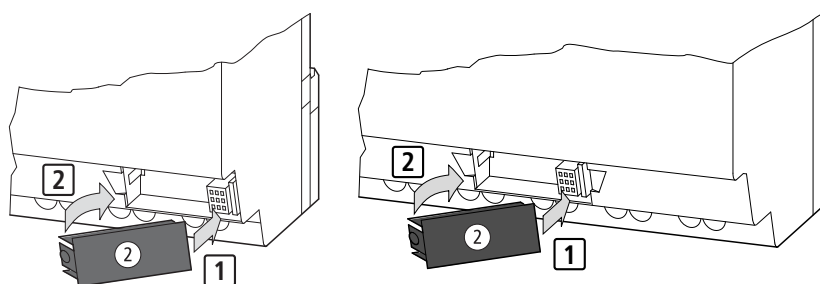

Figure 99: Inserting the memory card



With easy you can insert and remove the memory card even if the power feed is switched on, without the risk of losing data.

6.7.2 Loading or saving circuit diagrams

You can only transfer circuit diagrams in STOP mode.

6.7.2.1 Behaviour of easy device without integrated keypad, display when loading the memory card

If a memory card is inserted in easy variants without an on-board keypad and LCD, the circuit diagram is automatically transferred from the memory card to the EASY...-...-...**X** when the power supply is switched on. If the memory card contains an invalid circuit diagram, the circuit diagram installed in the easy is retained.

6.7.2.2 Behavior of the easy devices with button field, display with memory card fitted

If easy does not contain a circuit diagram, this is automatically loaded from the memory card when the easy is switched on.



The memory card is detected when the card is inserted and you move from the main menu to the program menu. As read access to EASY-M-8K, EASY-M-16K and EASY-M-32K cards is possible, the card can only be removed in the Status display. This ensures that the correct card is always detected. Only the EASY-M-32K memory card can be written to.

```
PROGRAM
DELETE PROG
CARD...
```

- ▶ Switch to STOP mode.
- ▶ Select PROGRAM... from the main menu.
- ▶ Select the CARD... menu option.

The CARD... menu option will only appear if you have inserted a functional memory card.

```
DEVICE-CARD
CARD-DEVICE
DELETE CARD
```

You can transfer a circuit diagram from easy to the card and from the card to the easy memory or delete the content of the card.



If the operating voltage fails during communication with the card, repeat the last step since easy may not have transferred or deleted all the data.

After transmission, remove the memory card and close the cover.

6.7.2.3 Saving a circuit diagram to the card

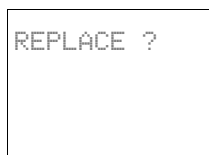

```
REPLACE ?
```

- ▶ Select DEVICE-CARD.
- ▶ Confirm the prompt with **OK** to delete the contents of the memory card and replace it with the easy circuit diagram.

Press **ESC** to cancel.

6.7.2.4 Loading a circuit diagram from the card

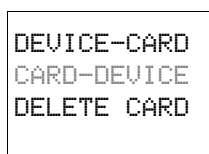

```
DEVICE-CARD  
CARD-DEVICE  
DELETE CARD
```

- ▶ Select the CARD → DEVICE menu option.
- ▶ Press **OK** to confirm the prompt if you want to delete the easy memory and replace it with the card content.

Press **ESC** to go back one menu.

CAUTION

Once you have started the CARD → DEVICE transfer, the following operation is initiated:

- The RAM of the device is loaded from the card.
- The internal program memory is cleared.
- The data is written from the card to the internal retentive program memory.

This is carried out in blocks. A complete program is not transferred to the RAM for space reasons.

If an invalid program or an interruption occurs during the read or write operation, easy500 or easy700 loses the program in the internal memory.

6.7.2.5 Deleting a circuit diagram on the card

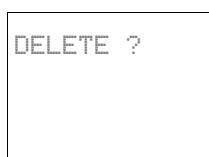

```
DELETE ?
```

- ▶ Select the DELETE CARD menu option.
- ▶ Press **OK** to confirm the prompt and to delete the card content.

Press **ESC** to cancel.

6.8 easySoft

easySoft-Basic and easySoft-Pro are PC programs for creating, testing and managing easy circuit diagrams.

6.8.1 Program transfer between easySoft and easy500/700



To transfer data between the PC and easy500/700 devices, only use the original programming cable supplied as an accessory:

- EASY-PC-CAB or
- EASY-USB-CAB



DANGER

There is a **danger** of electric shock on easy AC devices if the L phase conductor and N neutral conductor are reversed.

For your safety:

- Use of this original programming cable ensures that the PC terminal is electrically isolated from the connection voltage of the L phase conductor (100 to 240 V AC) if the phase conductor and neutral conductor are reversed. The original programming cables are optocoupled.

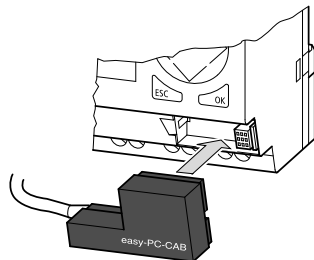

Figure 100: Plug in programming cable

- ▶ Connect the programming cable to the serial PC interface.
- ▶ Fit the easy plug into the opened multi-function interface.
- ▶ Activate the Status display on the easy.



easy cannot exchange data with the PC while the circuit diagram display is on screen.

The easySoft-Basic or easySoft-Pro programming software allows you to transfer circuit diagrams from the PC to the easy device or vice versa. You can also switch the device to RUN mode from easySoft in order to test the program in the actual wiring.

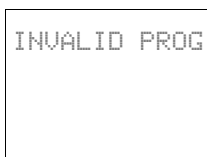

If there are transmission problems, easy will display the INVALID PROG message.

- ▶ Check whether the circuit diagram is suitable for the destination device.



If the operating voltage fails during communication with the PC, repeat the last step. It is possible that not all the data was transferred between the PC and easy.

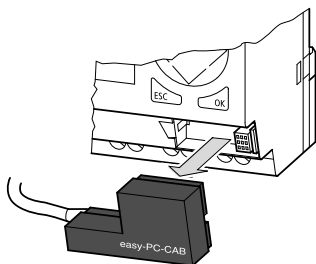

Figure 101: Removing the EASY-PC-CAB

- ▶ After transmission, remove the cable and close the interface.

6.8.2 easySoft help

easySoft is provided with an extensive Online Help.

- ▶ Start easySoft-Basic or easySoft-Pro and click the ? menu item in order to open the Help.

The help provides all the additional information about easySoft that you will need.

6 easy Internal

6.9 easy with a remote display and operator unit

6.9 easy with a remote display and operator unit

easy500/700 devices can be operated with a remote display and operator unit. In this configuration, all the display information is transferred via the serial multi-function interface.

This has the advantage that easy can be operated remotely. The texts in easy are backlit and displayed on the front of the operator or control panel in twice the size. The display/operating unit provides protection to IP65.

If a display/operating unit with a keypad is used, easy can be programmed and assigned parameters from "outside".



Card mode operation is not possible when using a stand-alone display/operating unit. The interface can only be used once.

The MFD-80 (IP65 display unit), MFD-80-B (IP65 display/operating unit) with the MFD-CP4-500 power supply/communication unit are currently available for use as stand-alone display/operating units.



The MFD-CP4 communication unit establishes permanent communication with the easy control relay. This increases easy's cycle time, and must be taken into account during engineering.

6.10 Device version

Every easy has the device version number printed on the left of the device housing. The device version is indicated by the first two digits of the device number.

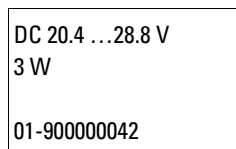

Figure 102: Example of device version

This device is of device version 01.

The device version provides useful service information about the hardware version and the version of the operating system. The device version is important for selecting the correct control relay for EASY-SOFT-BASIC.

7 What Happens If ...?

You may sometimes find that easy does not do exactly what you expect. If this happens, read through the following notes which are intended to help you solve some of the problems you may encounter.

You can use the power flow display in easy to check the logic operations in the easy circuit diagram with reference to the switching states of contacts and relays.

Only qualified persons should test easy voltages while the device is in operation.

7.1 Messages from the easysystem

| easy system messages on the LCD | Explanation | Remedy |
|---------------------------------|---|----------------------------|
| No display | Power supply interrupted | Switch on the power supply |
| | easy LCD faulty | Replace easy |
| Continuous display | | |
| TEST: AC | Self-test aborted | Replace easy |
| TEST: EEPROM | | |
| TEST: DISPLAY | | |
| TEST: CLOCK | | |
| ERROR: I2C | Memory card removed or not inserted correctly before saving | Inserting the memory card |
| | Memory card faulty | Replace memory card |
| | easy is faulty | Replace easy |
| ERROR: EEPROM | The memory for storing the retentive values or the easy circuit diagram memory is faulty. | Replace easy |
| ERROR: CLOCK | Clock error | Replace easy |
| ERROR: LCD | LCD is faulty | Replace easy |
| ERROR: ACLOW | Incorrect AC voltage | Test the voltage |
| | easy is faulty | Replace easy |

7 What Happens If ...?

7.2 Possible situations when creating circuit diagrams

7.2 Possible situations when creating circuit diagrams

| Possible situations when creating circuit diagrams | Explanation | Remedy |
|---|--|---|
| Cannot enter contact or relay in circuit diagram | easy is in RUN mode | Select STOP mode |
| Time switch switches at wrong times | Time or time switch parameters not correct | Check time and parameters |
| Message when using a memory card PROG INVALID | easy memory card contains no circuit diagram Circuit diagram on the memory card uses contacts/relays that easy does not recognize | Change the version of easy or change the circuit diagram on the memory card |
| Power flow display does not show changes to the rungs | easy is in STOP mode | Select RUN mode |
| | Association/connection not fulfilled | Check and modify circuit diagram and parameter sets |
| | Relay does not activate coil | |
| | Incorrect parameter values/time | |
| | <ul style="list-style-type: none"> Analog value comparison is incorrect Time value of timing relay is incorrect Function of timing relay is incorrect | |
| Relay Q or M does not pick up | Relay coil has been wired up several times | Check coil field entries |
| Input not detected | Loose terminal contact | Check installation instructions, check external wiring |
| | No voltage to switch/button | |
| | Wire breakage | |
| | easy input is faulty | Replace easy |
| Relay output Q does not switch and activate the load | easy in STOP mode | Select RUN mode |
| | No voltage at relay contact | Check installation instructions, check external wiring |
| | easy power supply interrupted | |
| | easy circuit diagram does not activate relay output | |
| | Wire breakage | |
| | easy relay is faulty | Replace easy |

7.3 Event

| Event | Explanation | Remedy |
|--|---|---|
| The actual values are not being stored retentively. | Retention has not been switched on. | Switch on retention in the SYSTEM menu. |
| The RETENTION... menu is not displayed in the SYSTEM menu. | easy is in RUN mode | Select STOP mode |
| The SYSTEM menu is not displayed. | This easy model does not have this menu. | Exchange easy if you need retention |
| easy starts only in operating mode STOP | No circuit diagram in easy | Load, input circuit diagram |
| | Startup behavior is set to the function "Startup in operating mode STOP". | Set the startup behavior in the SYSTEM menu. |
| LCD display showing nothing. | No power supply | Switch on the power supply |
| | easy is faulty | Press the OK button. If no menu appears, replace the easy. |
| | Text displayed with too many spaces | Enter text or do not select |
| GW flashes on the Status display | EASY200-EASY bus coupler detected without I/O expansion | Connect I/O expansion to external easyLink |

7 What Happens If ...?

7.3 Event

8 Appendix

8.1 Approval and Certification

easy500/700 devices are approved for several countries and regions as well as for shipboard use. The same applies to expansion devices.

8.1.1 Approvals and national approvals for easy500/700 devices

| | |
|--------------------------|--|
| Product standards | <ul style="list-style-type: none"> • IEC/EN → section "8.3.1 Standards", page 210; • 508 (INDUSTRIAL CONTROL EQUIPMENT); • CSA C22.2 No. 142-M1987 (Process Control Equipment); • CSA C22.2 No. 213-M1987 (Non-Incendive Electrical Equipment for Use in Class I, Division 2 Hazardous Locations) • CE-mark • C-TICK Label |
| File no. | E135462 |
| CCN | NRAQ |
| CSA File No. | 012528 |
| CSA Class No. | 2252-01 + 2258-02 (for Hazardous Locations) |
| NA Certification | Listed, CSA certified |
| C-TICK Label No. | N4246 |
| Protection type | IEC: IP20; /CSA Type : - |

MFD-Titan devices are approved for Russia, in accordance with GOST-R and for the Ukraine in accordance with Ukrain-GOST.

8.1.2 Shipping approvals for easy500/700 devices

| easy500/700 | BV (Bureau Veritas) | DNV (DET NORSKE VERITAS) | GL (Germanischer Lloyd) | LR (Lloyds Register of Shipping) |
|---------------------|-------------------------------|---------------------------------------|--------------------------------------|---|
| Certificate number: | 21606/A0 BV | A-11768 | 32920-06 HH | 06/20051 |

8 Appendix

8.2 Dimensions

8.1.3 Approvals and national approvals for expansion devices

| | |
|-----------------------------|--|
| Product standards | <ul style="list-style-type: none"> • IEC/EN → section "8.3.1 Standards", page 210; • 508 (INDUSTRIAL CONTROL EQUIPMENT); • CSA C22.2 No. 142-M1987 (Process Control Equipment); • CSA C22.2 No. 213-M1987 (Non-Incendive Electrical Equipment for Use in Class I, Division 2 Hazardous Locations) • CE-mark |
| File no. | E135462 |
| CCN | NRAQ, NRAQ7 |
| CSA File No. | 012528 |
| CSA Class No. | 2252-01 + 2258-02 (for Hazardous Locations) |
| NA Certification | Listed, CSA certified |
| Protection type I/O modules | IEC: IP20; /CSA Type : - |

Expansion devices are also approved for Russia, in accordance with GOST-R and for the Ukraine in accordance with Ukrain-GOST.

8.1.4 Shipping approvals for expansion units easy6..

| easy6.. | BV (Bureau Veritas) | DNV (DET NORSKE VERITAS) | GL (Germanischer Lloyd) | LR (Lloyds Register of Shipping) |
|---------------------|-------------------------------|---------------------------------------|--------------------------------------|---|
| Certificate number: | - | - | 42991- 02 HH easy6.. | 02/20029 EASY618...-RE |

8.2 Dimensions

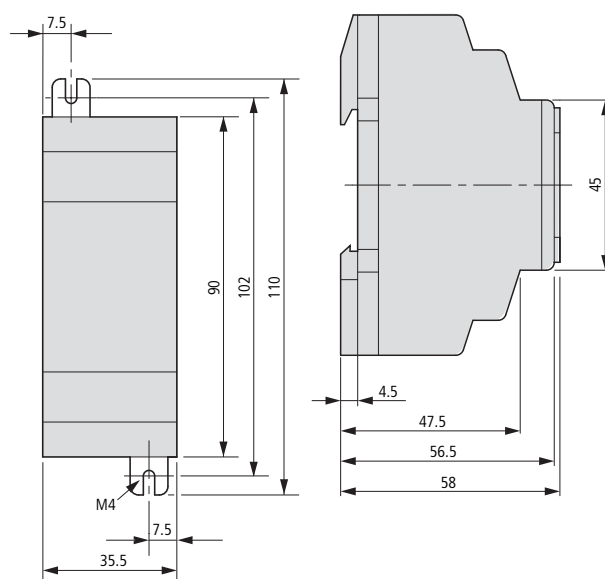

Figure 103: Dimensions of easy200 in mm (for dimensions in inches see table 36, page 209)

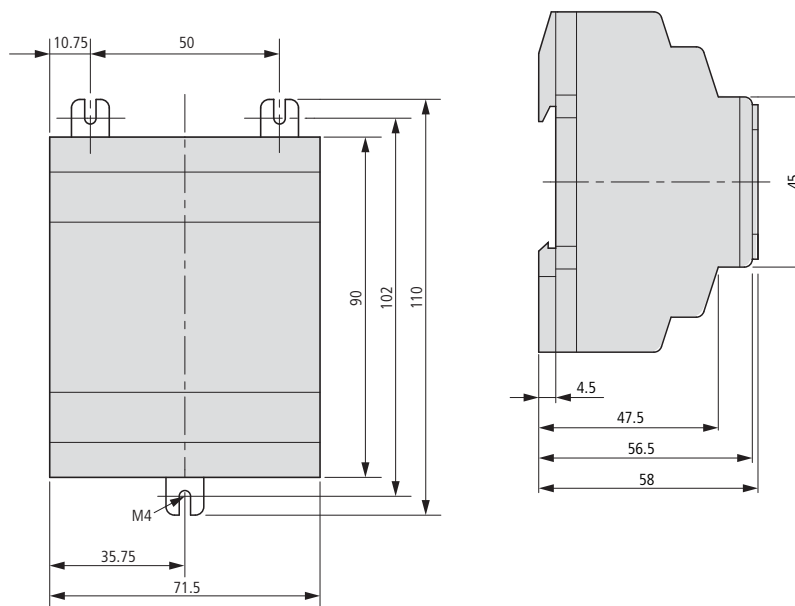

Figure 104: Dimensions of easy512-... in mm (for dimensions in inches see table 36)

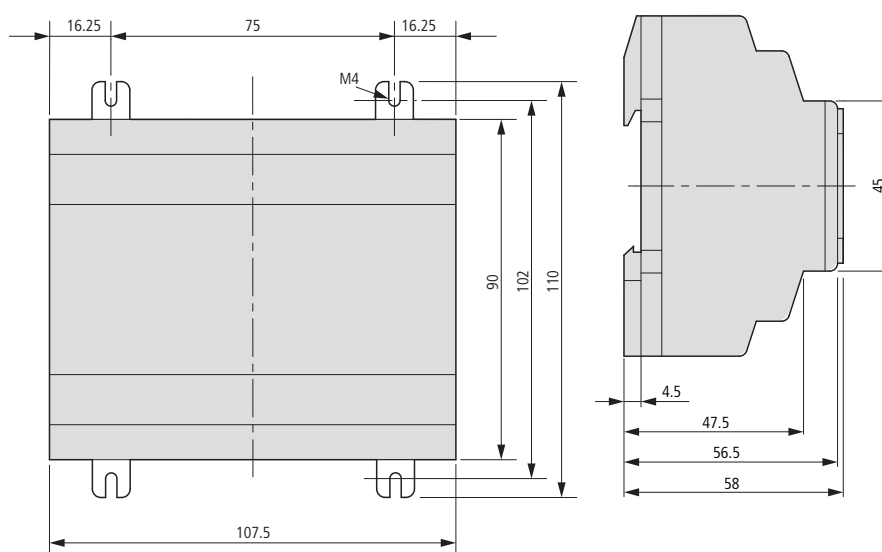

Figure 105: Dimensions of easy600, easy700 in mm (for dimensions in inches see table 36)

Table 36: Dimensions in inches

| mm | inches | mm | inches |
|-------|--------|-------|--------|
| 4.5 | 0.177 | 56.5 | 2.22 |
| 7.5 | 0.295 | 58 | 2.28 |
| 10.75 | 4.23 | 71.5 | 2.81 |
| 16.25 | 0.64 | 75 | 2.95 |
| 35.5 | 1.4 | 90 | 3.54 |
| 35.75 | 1.41 | 102 | 4.01 |
| 45 | 1.77 | 107.5 | 4.23 |
| 47.5 | 1.87 | 110 | 4.33 |
| 50 | 1.97 | | |

8.3 Technical data

8.3.1 Standards

| | easy500/700 |
|-----------|---|
| Standards | EN 55011, EN 55022, IEC EN 61000-4, IEC60068-2-6, IEC60068-2-27 |

8.3.2 General

| | easy200 | easy512 | easy600, easy700 |
|------------------------|---|-------------------------|-------------------------|
| Dimensions W x H x D | | | |
| [mm] | 35.5 x 90 x 56.5 | 71.5 x 90 x 56.5 | 107.5 x 90 x 56.5 |
| [inches] | 1.4 x 3.54 x 2.08 | 2.81 x 3.54 x 2.08 | 4.23 x 3.54 x 2.08 |
| Space units (SU) width | 2 SU (space units) wide | 4 SU (space units) wide | 6 space units wide |
| Weight | | | |
| [g] | 70 | 200 | 300 |
| [lb] | 0.154 | 0.441 | 0.661 |
| Mounting | DIN 50022, 35 mm rail or screw mounting with 3 ZB4-GF1 fixing brackets (accessories); with easy200 only 2 fixing brackets required. | | |

Climatic environmental conditions (Cold to IEC 60068-2-1, Heat to IEC 60068-2-2)

| | |
|--|---|
| Operating ambient temperature Installed horizontally/vertically | -25 to 55 °C, -13 to 131 °F |
| Condensation | Prevent condensation with suitable measures |
| LCD display (reliably legible) | 0 - 55 °C, 32 to 131 °F |
| Storage/transport temperature | -40 to +70 °C, -40 to 158 °F |
| Relative humidity (IEC 60068-2-30) | 5 to 95 %, non-condensing |
| Air pressure (in operation) | 795 - 1080 hPa |
| Corrosion resistance | |
| IEC 60068-2-42 | SO ₂ 10 cm ³ /m ³ , 4 days |
| IEC 60068-2-43 | H ₂ S 1 cm ³ /m ³ , 4 days |
| Inflammability class to UL 94 | V 0 |

Ambient mechanical conditions

| | |
|--|--|
| Pollution degree | 2 |
| Degree of protection (EN 50178, IEC 60529, VBG4) | IP20 |
| Vibration (IEC 60068-2-6) | 10 - 57 Hz (Constant amplitude 0.15 mm) 57 - 150 Hz (constant acceleration 2 g) |
| Shock (IEC 60068-2-27) | 18 shocks (semi-sinusoidal 15 g/11 ms) |
| Drop (IEC 60068-2-31) | Drop height 50 mm |
| Free fall, when packed (IEC 60068-2-32) | 1 m |

| Electromagnetic compatibility (EMC) | |
|--|--|
| Electrostatic discharge (ESD), (IEC/EN 61 000-4-2, severity level 3) | 8 kV air discharge, 6 kV contact discharge |
| Electromagnetic fields (RFI), (IEC/EN 61000-4-3) | Field strength 10 V/m |
| Emitted interference Interference immunity (EN 55011, EN 55022) IEC 61000-6-1,2,3,4 | Class B |
| Fast transient burst (IEC/EN 61000-4-4, severity level 3) | 2 kV power cables, 2 kV signal cables |
| High-energy pulses (surge) easy-AC , (IEC/EN 61000-4-5) | 2 kV power cable symmetrical |
| Surge easy-DA, easy-DC, easy-AB (IEC/EN 61000-4-5, severity level 2) | 0.5 kV power cable symmetrical |
| Immunity to line-conducted interference to (IEC/EN 61000-4-6) | 10 V |
| Insulation resistance | |
| Clearance in air and creepage distances | EN 50178, UL 508, CSA C22.2, No 142 |
| Insulation resistance | EN 50178 |
| Overvoltage category/degree of pollution | II/2 |
| Tools and cable cross-sections | |
| solid | $\geq 0.2 \text{ mm}^2, \leq 4 \text{ mm}^2/\text{AWG}: 22 - 12$ |
| flexible with ferrule | $\geq 0.2 \text{ mm}^2, \leq 2.5 \text{ mm}^2/AWG: 22 - 12Factory wiring: to AWG 30$ |
| Slot-head screwdriver, width | 3.5 x 0.8 mm |
| Tightening torque | 0.6 Nm |
| Backup/accuracy of real-time clock (only with easy-C) | |
| Back-up of the clock | <p>① = backup time in hours ② = service life in years</p> |
| Accuracy of the real-time clock | |
| Repetition accuracy of timing relays | |
| Accuracy of timing relays | $\pm 1 \%$ of value |
| Resolution | |
| Range "s" | 10 ms |
| Range "M:S" | 1 s |
| Range "H:M" | 1 min. |
| Retentive memory | |
| Write cycles of the retentive memory (minimum) | 1 000 000 |
| Rungs (basic units) | |
| EASY512, easy700 | 128 |

8.3.3 Power supply

8.3.3.1 EASY512-AC-..., EASY719-AC-..., EASY512-AB-..., EASY719-AB-...

| | EASY512-AB-..., EASY719-AB-... | EASY512-AC-..., EASY719-AC-... |
|-----------------------------------|---------------------------------|--------------------------------|
| Rated value (sinusoidal) | 24 V AC | 100/110/115/120/230/240 V AC |
| Operating range | +10/-15 % 20.4 - 26.4 V AC | +10/-15 % 85 - 264 V AC |
| Frequency, rated value, tolerance | 50/60 Hz, 6 5 % | 50/60 Hz, 65 % |
| Input current consumption | EASY512-AB-... EASY719-AB-... | EASY512-AB-... EASY719-AB-... |
| At 115/120 V AC 60 Hz | | Normally 40 mA Normally 70 mA |
| at 230/240 V AC 50 Hz | | Normally 20 mA Normally 35 mA |
| At 24 V AC 50/60 Hz | Normally 200 mA Normally 300 mA | |
| Voltage dips | 20 ms, IEC/EN 61131-2 | 20 ms, IEC/EN 61131-2 |
| Heat dissipation | EASY512-AB-... EASY719-AB-... | EASY512-AC-... EASY719-AC-... |
| At 115/120 V AC | | Normally 5 VA Normally 10 VA |
| at 230/240 V AC | | Normally 5 VA Normally 10 VA |
| At 24 V AC | Normally 5 VA Normally 7 VA | |
| Potential isolation | | |
| from the inputs | No | No |
| from the outputs | Yes | Yes |
| for analog inputs | No | - |
| for Multi-function interface | No | No |
| to EASY-Link | No | No |

8.3.3.2 EASY512-DA-..., EASY719-DA-..., EASY512-DC-..., EASY719-DC-..., EASY721-DC-...

| | EASY512-DA-..., EASY719-DA-... | EASY512-DC-..., EASY719-DC-..., EASY721-DC-... |
|--------------------------------|---------------------------------|--|
| Rated voltage | | |
| Nominal value | 12 V DC, +30 %, -15 % | 24 V DC, +20 %, -15 % |
| Permissible range | 10.2 - 15.6 V DC | 20.4 - 28.8 |
| Ripple | ≤ 5 % | ≤ 5 % |
| Input current at rated voltage | EASY512-DA-... EASY719-DA-... | EASY512-DC-... EASY719-DC-... EASY721-DC-... |
| | Normally 140 mA Normally 200 mA | Normally 80 mA Normally 140 mA |
| Voltage dips | 10 ms, IEC/EN 61 131-2 | 10 ms, IEC/EN 61 131-2 |
| Heat dissipation | EASY512-DA-... EASY719-DA-... | EASY512-DC-... EASY719-DC-... EASY721-DC-... |
| | Normally 2 W Normally 3.5 W | Normally 2 W Normally 3.5 W |

8.3.4 Digital inputs

8.3.4.1 EASY-512-AB-..., EASY719-AB-...

| | EASY-512-AB-... | EASY719-AB-... |
|--|---|--|
| Digital inputs 24 V AC | | |
| Number | 8 | 12 |
| Status display | LCD (if provided) | LCD (if provided) |
| | 2 inputs (I7, I8) usable as analog inputs | 4 inputs (I7, I8, I11, I12) usable as analog inputs |
| Potential isolation | | |
| From power supply | No | No |
| between digital inputs | No | No |
| from the outputs | Yes | Yes |
| Rated voltage L (sinusoidal) | 24 V AC | 24 V AC |
| At signal "0" | 0 to 6 V AC | 0 to 6 V AC |
| At signal "1" | (I7, I8) > 8 V AC, > 11 V DC (I1 - I6) 14 - 26.4 V AC | (I7, I8, I11, I12) > 8 V AC, > 11 V DC (I1 - I6, I9, I10) 14 - 26.4 V AC |
| Rated frequency | 50/60 Hz | 50/60 Hz |
| Input current with "1" signal I1 to I6 (EASY719.. also I9 to I10) | 4 mA at 24 V AC 50 Hz0 | 4 mA at 24 V AC, 50 Hz |
| Input current on signal I7, I8, (EASY719.. also I11, I12) | 2 mA at 24 V AC 50 Hz, 2 mA at 24 V DC | 2 mA at 24 V AC 50 Hz, 2 mA at 24 V DC |
| Delay time for 0 to 1 and 1 to 0 for I1 to I8, EASY719... also I9 to I12 | | |
| Debounce ON | 80 ms (50 Hz), 66 ² / ₃ ms (60 Hz) | 80 ms (50 Hz), 66 ² / ₃ ms (60 Hz) |
| Debounce OFF | 20 ms (50 Hz), 16 ² / ₃ ms (60 Hz) | 20 ms (50 Hz), 16 ² / ₃ ms (60 Hz) |
| Max. permissible cable length (per input) | | |
| I1 to I8, (to EASY719... also I9 to I10) | Normally 40 m | Normally 40 m |

8 Appendix
8.3 Technical data

8.3.4.2 EASY-512-AC-..., EASY618-AC-E, EASY719-AC-...

| | EASY-512-AC-... | EASY618-AC-E, EASY719-AC-... |
|--|--|---|
| Digital inputs 115/230 V AC | | |
| Number | 8 | 12 |
| Status display | LCD (if provided) | LCD (if provided) |
| Potential isolation | | |
| From power supply | No | No |
| between digital inputs | No | No |
| from the outputs | Yes | Yes |
| Rated voltage L (sinusoidal) | | |
| At signal "0" | 0 - 40 V AC | 0 - 40 V AC |
| At signal "1" | 79 - 264 V AC | 79 - 264 V AC |
| Rated frequency | 50/60 Hz | 50/60 Hz |
| Input current with "1" signal R1 to R12, I1 to I6 (EASY71. also I9 to I12) | 6 x 0.5 mA at 230 V AC 50 Hz, 6 x 0.25 mA at 115 V AC 60 Hz | 10 x (12) 0.5 mA at 230 V AC, 50 Hz 10 x (12) x 0.25 mA at 115 V AC, 60 Hz |
| Input current on signal 1 I7, I8 | 2 x 6 mA at 230 V AC 50 Hz, 2 x 4 mA at 115 V AC 60 Hz | 2 x 6 mA at 230 V AC 50 Hz, 2 x 4 mA at 115 V AC 60 Hz |
| Delay time for 0 to 1 and 1 to 0 for I1 to I6, I9 to I12 | | |
| Debounce ON | 80 ms (50 Hz), 66 ² / ₃ ms (60 Hz) | 80 ms (50 Hz), 66 ² / ₃ ms (60 Hz) |
| Debounce OFF (also R1 to R12) | 20 ms (50 Hz), 16 ² / ₃ ms (60 Hz) | 20 ms (50 Hz), 16 ² / ₃ ms (60 Hz) |
| Delay time I7, I8 for 1 to 0 | | |
| Debounce ON | 160 ms (50 Hz), 150 ms (60 Hz) | 80 ms (50 Hz), 66 ² / ₃ ms (60 Hz) |
| Debounce OFF | 100 ms (50 Hz/60 Hz) | 20 ms (50 Hz), 16 ² / ₃ ms (60 Hz) |
| Delay time I7, I8 for 0 to 1 | | |
| Debounce ON | 80 ms (50 Hz), 66 ² / ₃ ms (60 Hz) | 80 ms (50 Hz), 66 ² / ₃ ms (60 Hz) |
| Debounce OFF | 20 ms (50 Hz), 16 ² / ₃ ms (60 Hz) | 20 ms (50 Hz), 16 ² / ₃ ms (60 Hz) |
| Max. permissible cable length (per input) | | |
| I1 to I6, R1 to R12 (at EASY719-.. also I9 to I12) | Normally 40 m | Normally 40 m |
| I7, I8 | Normally 100 m | Normally 100 m |

8.3.4.3 EASY512-DA-..., EASY719-DA-...

| | EASY512-DA-... | EASY719-DA-... |
|--------------------------------|--|---|
| Digital inputs | | |
| Number | 8 | 12 |
| Inputs usable as analog inputs | I7, I8 | I7, I8, I11, I12 |
| Status display | LCD (if provided) | LCD (if provided) |
| Potential isolation | | |
| from power supply | No | No |
| between digital inputs | No | No |
| from the outputs | Yes | Yes |
| Rated voltage | | |
| Nominal value | 12 V DC | 12 V DC |
| At signal "0" | 4 V DC (I1 - I8) | 4 V DC (I1 - I12,) |
| At signal "1" | 8 V DC (I1 - I8) | 8 V DC (I1 - I12) |
| Input current on signal 1 | | |
| I7, I8, (I11, I12) | 3.3 mA at 12 V DC (I1 - I6) 1.1 mA at 12 V DC | 3.3 mA at 12 V DC (I1 to I6, I9 - I10) 1.1 mA at 12 V DC |
| Delay time from 0 to 1 | | |
| Debounce ON | 20 ms | 20 ms |
| Debounce OFF | Normally 0.3 ms (I1 - I6) Normally 0.35 ms (I7, I8) | Normally 0.3 ms (I1 - I6, I9, I10) Normally 0.35 ms (I7, I8, I11, I12) |
| Delay time from 1 to 0 | | |
| Debounce ON | 20 ms | 20 ms |
| Debounce OFF | Normally 0.3 ms (I1 - I6) Normally 0.15 ms (I7, I8) | type 0.4 ms (I1 to I6, I9 - I10) Normally 0.2 ms (I7, I8, I11, I12) |
| Cable length (unscreened) | 100 m | 100 m |

8.3.4.4 EASY512-DC-..., EASY6..-DC-.E, EASY7..-DC-...

| | EASY512-DC-... | EASY6..-DC-.E | EASY7..-DC-... |
|---|---|------------------------------|--|
| Digital inputs | | | |
| Number | 8 | 12 | 12 |
| Inputs usable as analog inputs | I7, I8 | | I7, I8, I11, I12 |
| Status display | LCD (if provided) | | |
| Potential isolation | | | |
| To power supply | No | No | No |
| between digital inputs | No | No | No |
| from the outputs | Yes | Yes | Yes |
| Rated voltage | | | |
| Nominal value | 24 V DC | 24 V DC | 24 V DC |
| At signal "0" | < 5 V DC (I1 to I8) | < 5 V DC (R1 to R12) | < 5 V DC (I1 to I12) |
| At signal "1" | > 8 V DC (I7, I8) | | > 8 V DC (I7, I8, I11, I12) |
| | > 15 V DC (I1 - I6) | > 15 V DC (R1 - R12) | > 15 V DC (I1 - I6, I9, I10) |
| Input current on signal 1 | 3.3 mA at 24 V DC (I1 - I6) | 3.3 mA at 24 V DC (R1 - R12) | 3.3 mA at 24 V DC (I1 - I6, I9, I10) |
| I7, I8 (easy7..-DC-... also I11, I12) | 2.2 mA at 24 V DC | | 2.2 mA at 24 V DC |
| Delay time from 0 to 1 | | | |
| Debounce ON | 20 ms | 20 ms | 20 ms |
| Debounce OFF easy512.DC-... I1 to I8 easy6..-DC-... R1 to R12 easy7.._DC-... I1 to I12 | Normally 0.25 ms | | |
| Delay time from 1 to 0 | | | |
| Debounce ON | 20 ms | 20 ms | 20 ms |
| Debounce OFF | <ul style="list-style-type: none"> • Normally 0.4 ms (I1 - I6) • Normally 0.2 ms (I7, I8) | Normally 0.4 ms (R1 - R12) | <ul style="list-style-type: none"> • Normally 0.4 ms (I1 - I6, I9, I10) • Normally 0.2 ms (I7, I8, I11, I12) |
| Cable length (unshielded) | 100 m | 100 m | 100 m |

8.3.5 Rapid counter inputs

| High-speed counter inputs, I1 to I4 | | EASY512-DA-..., EASY512-DC-..., EASY719-DA-..., EASY719-DC-..., EASY721-DC-... |
|--|-----|--|
| Quantity | | 4 |
| Cable length (shielded) | m | 20 |
| High-speed up and down counter | | |
| Counter frequency | kHz | ≤ 1 |
| Pulse shape | | Square |
| Pulse Pause Ratio | | 1:1 |
| Frequency Counter | | |
| Counter frequency | kHz | ≤ 1 |
| Pulse shape | | Square |
| Pulse Pause Ratio | | 1:1 |

8.3.6 Analog inputs

| | EASY512-AB-..., EASY512-DA-..., EASY512-DC-... | EASY719-AB-..., EASY719-DA-..., EASY719-DC-..., EASY721-DC-... |
|---------------------------------------|---|---|
| Analog inputs I7, I8, I11, I12 | | |
| Number | 2 | 4 |
| Potential isolation | | |
| from power supply | No | No |
| To the digital inputs | No | No |
| from the outputs | Yes | Yes |
| Input type | DC voltage | DC voltage |
| Signal range | 0-10 V DC | 0-10 V DC |
| Resolution, analog | 10 mV | 10 mV |
| Resolution, digital | 0.01 (10 Bit, 1 - 1023) | 0.01 (10 Bit, 0 - 1023) |
| Input impedance | 11.2 kΩ | 11.2 kΩ |
| Accuracy | | |
| Two easy devices | ± 3 % of actual value | ± 3 % of actual value |
| Within a single device | ± 2 % of actual value (I7, I8), ± 0.12 V | |
| Conversion time, analog/ digital | Debounce ON: 20 ms Debounce OFF: every cycle | |
| Input current at 10 V DC | 1 mA | 1 mA |
| Cable length (shielded) | 30 m | 30 m |

8 Appendix

8.3 Technical data

8.3.7 Relay outputs

8.3.7.1 EASY512-...-R..., EASY618-...-RE/EASY719-...-R., EASY202-RE

| | EASY512-...-R... | EASY618-...-RE/ EASY719-...-R.. | EASY202-RE |
|--|--|------------------------------------|------------|
| Number | 4 | 6 | 2 |
| Type of outputs | Relay | | |
| In groups of | 1 | 1 | 2 |
| Parallel switching of outputs to increase performance | Not permissible | | |
| Protection for an output relay | Miniature circuit-breaker B16 or fuse 8 A (slow) | | |
| Potential isolation from power supply, inputs | Yes 300 V AC (safe isolation) 600 V AC (basic isolation) | | |
| Mechanical lifespan (Operations) | 10 x 10 ⁶ | | |
| Contacts relays | | | |
| Conventional therm. current | 8 A (10 A UL) | | |
| Recommended for load | > 500 mA, 12 V AC/DC | | |
| Protected against short-circuit $\cos \varphi = 1$ | 16 A characteristic B (B16) at 600 A | | |
| Short-circuit proof $\cos \varphi = 0.5$ to 0.7 | 16 A characteristic B (B16) at 900 A | | |
| Rated impulse withstand voltage U_{imp} contact coil | 6 kV | | |
| Rated insulation voltage U_i | | | |
| Rated operational voltage U_e | 250 V AC | | |
| Safe isolation to EN 50178 between coil and contact | 300 V AC | | |
| Safe isolation to EN 50178 between two contacts | 300 V AC | | |
| Making capacity | | | |
| AC-15 250 V AC, 3 A (600 Ops/h) | 300 000 operations | | |
| DC-13 L/R ≤ 150 ms 24 V DC, 1 A (500 S/h) | 200 000 operations | | |
| Breaking capacity | | | |
| AC-15 250 V AC, 3 A (600 Ops/h) | 300 000 operations | | |
| DC-13 L/R ≤ 150 ms 24 V DC, 1 A (500 S/h) | 200 000 operations | | |

| | EASY512-...-R... | EASY618-...-RE/ EASY719-...-R.. | EASY202-RE |
|--|---|------------------------------------|------------|
| Filament bulb load | 1000 W at 230/240 V AC/25000 operations 500 W at 115/120 V AC/25000 operations | | |
| Fluorescent tube with ballast | 10 x 58 W at 230/240 V AC/25000 operations | | |
| Conventional fluorescent tube, compensated | 1 x 58 W at 230/240 V AC/25000 operations | | |
| Fluorescent tube, uncompensated | 10 x 58 W at 230/240 V AC/25000 operations | | |
| Operating frequency, relays | | | |
| Mechanical switching operations | 10 million (1 x 10 ⁷) | | |
| Mechanical switching frequency | 10 Hz | | |
| Resistive lamp load | 2 Hz | | |
| Inductive load | 0.5 Hz | | |

8.3.7.2 UL/CSA

| | | |
|--|---|-----------------------|
| Continuous current at 240 V AC/24 V DC | | 10/8 A |
| AC | Control Circuit Rating Codes (Utilization category) | B300 Light Pilot Duty |
| | Max. rated operational voltage | 300 V AC |
| | Max. thermal continuous current $\cos \varphi = 1$ at B300 | 5 A |
| | Maximum make/break capacity $\cos \varphi \neq 1$ (NO/NC) at B300 | 3600/360 VA |
| DC | Control Circuit Rating Codes (Utilization category) | R300 Light Pilot Duty |
| | Max. rated operational voltage | 300 V DC |
| | Max. thermal continuous current with R300 | 1 A |
| | Maximum apparent On/off power with R300 | 28/28 VA |

8 Appendix

8.3 Technical data

8.3.8 Transistor outputs

8.3.8.1 EASY-512-D.-T..., EASY620-DC-.E, EASY72...

| | EASY512-D.-T... | EASY620-DC-.E, EASY72... |
|--|--|--|
| Number of outputs | 4 | 8 |
| Contacts | Semiconductor | Semiconductor |
| rated voltage U_e | 24 V DC | 24 V DC |
| permissible range | 20.4 - 28.8 V DC | 20.4 - 28.8 V DC |
| Ripple | $\leq 5 \%$ | $\leq 5 \%$ |
| Supply current | | |
| At signal "0" | Normally 9 mA, ≤ 16 mA | Normally 18 mA, ≤ 32 mA |
| At signal "1" | Normally 12 mA, ≤ 22 mA | Normally 24 mA, ≤ 44 mA |
| Protection against polarity reversal | yes, Caution! If voltage is applied to the outputs when the polarity of the supply voltage is reversed, this will result in a short-circuit. | |
| Potential isolation to mains supply, inputs | Yes | Yes |
| Rated operational current I_e on "1" signal | ≤ 0.5 A DC | ≤ 0.5 A DC |
| Lamp load | 5 Watts without R_V | 5 Watts without R_V |
| Residual current on signal 0 per channel | < 0.1 mA | < 0.1 mA |
| Max. output voltage | | |
| On "0" signal with ext. load, 10 MV | 2.5 V | 2.5 V |
| On "1" signal, $I_e = 0.5$ A | $U = U_e - 1$ V | $U = U_e - 1$ V |
| Short-circuit protection | Yes, thermal (analysis via diagnostics input I16, I15; R16, R15) | |
| Short-circuit tripping current for $R_a \leq 10$ m Ω | 0.7 A $\leq I_e \leq 2$ A per output | |
| Max. total short-circuit current | 8 A | 16 A |
| Peak short-circuit current | 16 A | 32 A |
| Thermal cutout | Yes | Yes |
| Max. switching frequency with constant resistive load R_L , 100 k Ω : operations/hour | 40 000 (depends on program and load) | |
| Parallel connection of outputs with a resistive load; inductive load with external suppressor (see page 46); combination within one group | Group 1: Q1 - Q4 | <ul style="list-style-type: none"> • Group 1: Q1 - Q4, S1 - S4 • Group 2: Q5 - Q8, S5 - S8 |

| | EASY512-D.-T... | EASY620-DC-.E, EASY72... |
|----------------------------------|---|--------------------------|
| Number of outputs | ≤ 4 | ≤ 4 |
| total maximum current | 2.0 A, Caution! Outputs must be actuated simultaneously and for the same time duration. | |
| Status indication of the outputs | LCD display (if provided) | |

Inductive load (without external suppressor circuit)

General explanations:

$T_{0.95}$ = time in milliseconds until 95 % of the stationary current is reached.

$$T_{0.95} \approx 3 \times T_{0.65} = 3 \times \frac{L}{R}$$

Utilization category in groups for:

- Q1 to Q4,
- Q5 to Q8,
- S1 to S4,
- S5 to S8.

| | | | |
|---|--|--------------|-------------------------------------|
| $T_{0.95} = 1 \text{ ms}$ $R = 48 \Omega$ $L = 16 \text{ mH}$ | Utilization factor | | $g = 0.25$ |
| | Relative duty factor | % | 100 |
| | Maximum switching frequency $f = 0.5$ Hz Maximum duty factor $DF = 50 \%$ | Operations/h | 1500 |
| | | | |
| DC13 $T_{0.95} = 72 \text{ ms}$ $R = 48 \Omega$ $L = 1.15 \text{ H}$ | Utilization factor | | $g = 0.25$ |
| | Relative duty factor | % | 100 |
| | Maximum switching frequency $f = 0.5$ Hz Maximum duty factor $DF = 50 \%$ | Operations/h | 1500 |
| | | | |
| Other inductive loads: | | | |
| $T_{0.95} = 15 \text{ ms}$ $R = 48 \Omega$ $L = 0.24 \text{ H}$ | Utilization factor | | $g = 0.25$ |
| | Relative duty factor | % | 100 |
| | Maximum switching frequency $f = 0.5$ Hz Maximum duty factor $DF = 50 \%$ | Operations/h | 1500 |
| | | | |
| Inductive load with external suppressor circuit for each load (see section "Connecting transistor outputs" on) | | | |
| | Utilization factor | | $g = 1$ |
| | Relative duty factor | % | 100 |
| | max. operating frequency Max. duty factor | Operations/h | Depending on the suppressor circuit |

8 Appendix

8.4 List of the function relays

8.4 List of the function relays

8.4.1 Usable contacts

| Switching contact | N/O | N/C | easy500 | easy700 | Page |
|---|-----|-----------|------------------------|-----------|------|
| Analog value comparator function relay | A | \bar{A} | A1...A16 | A1...A16 | 82 |
| Counter function relays | CSA | \bar{C} | C1...C16 | C1...C16 | 94 |
| Text display function relay | D | \bar{D} | D1...D16 | D1...D16 | 109 |
| weekly timer function relays | Ø | $\bar{Ø}$ | Ø1?Ø8 | Ø1?Ø8 | 113 |
| easy input terminal | I | \bar{I} | I1...I8 | I1...I12 | 66 |
| 0 signal | | | I13 | I13 | |
| Expansion status | | | – | I14 | 194 |
| Short-Circuit/Overload | | | I16 | I15...I16 | 192 |
| Markers, (auxiliary relay) | M | \bar{M} | M1...M16 | M1...M16 | 72 |
| Markers (auxiliary relay) | N | \bar{N} | N1...N16 | N1...N16 | |
| Operating Hours Counter | O | \bar{O} | O1...O4 | O1...O4 | 118 |
| Cursor button | P | \bar{P} | P1...P4 | P1...P4 | 70 |
| easy output | q | ? | Q1...Q4 | Q1...Q8 | 66 |
| Input terminal for expansion unit | R | \bar{R} | – | R1...R12 | 66 |
| Short-circuit/overload with expansion | R | \bar{R} | – | R15...R16 | 192 |
| easy output (expansion or S auxiliary marker) | CSA | \bar{S} | S1...S8 (as marker) | S1...S8 | 72 |
| Timer function relays | T | \bar{T} | T1...T16 | T1...T16 | 122 |
| Jump label | : | – | :1...:8 | :1...:8 | 135 |
| Year Time Switch | Y | \bar{Y} | Y1...Y8 | Y1...Y8 | 137 |
| Master reset, (central reset) | Z | \bar{Z} | Z1...Z3 | Z1...Z3 | 147 |

8.4.2 Available function relays

| Relay | easy display | easy500 | easy700 | Coil function | Parameters |
|--|--------------|------------------------|----------|---------------|------------|
| Analog value comparator function relay | CSA | A1...A16 | A1...A16 | – | ✓ |
| Counter function relays | C | C1...C16 | C1...C16 | ✓ | ✓ |
| Text marker function relay | D | D1...D16 | D1...D16 | ✓ | ✓ |
| weekly timer function relays | ⓪ | ⓪1?⓪8 | ⓪1?⓪8 | – | ✓ |
| Markers (auxiliary relay) | M | M1...M16 | M1...M16 | ✓ | – |
| Markers (auxiliary relay) | N | N1...N16 | N1...N16 | ✓ | – |
| Operating Hours Counter | O | O1...O4 | O1...O4 | ✓ | ✓ |
| easy output relays | q | Q1...Q4 | Q1...Q8 | ✓ | – |
| easy output relay expansion, auxiliary markers | S | S1...S8 (as marker) | S1...S8 | ✓ | – |
| Timer function relays | T | T1...T16 | T1...T16 | ✓ | ✓ |
| Conditional Jump | : | :1...:8 | :1...:8 | ✓ | – |
| Year Time Switch | Y | Y1...Y4 | Y1...Y4 | – | ✓ |
| Master reset, (central reset) | Z | Z1...Z8 | Z1...Z8 | ✓ | – |

8.4.3 Names of relays

| Relay | Meaning of abbreviation | Function relay designation | Page |
|-------|-------------------------|----------------------------|------|
| A | Analog value comparator | Analog value comparator | 82 |
| C | counter | Counter | 94 |
| D | display | Text Display | 109 |
| ⓪ | (week, Software) | Weekly timer | 113 |
| O | operating time | Operating Hours Counter | 118 |
| T | timing relays | Timing Relay | 122 |
| Y | year | Year Time Switch | 137 |
| Z | zero reset, | Master Reset | 147 |

8 Appendix

8.5 Compatibility of the function relay parameters

8.4.4 Names of function relay

| Function relay coil | Meaning of abbreviation | Description |
|---------------------|-------------------------|---|
| C | count input | Counter input, counter |
| D | direction input | Counter direction, counter |
| H | hold, stop | Stopping of timing relay, stop, timing relay |
| R | reset | Reset of actual value to zero, operating hours counters, counters, text displays, timing relays |
| T | trigger | Timing coil, timing relay |

8.4.5 Name of function block inputs (constants, operands)

| Input | Meaning of abbreviation | Description |
|-------|-------------------------|---|
| F1 | Factor 1 | Gain factor for I1 (I1 = F1 x Value) |
| F2 | Factor 2 | Gain factor for I2 (I2 = F2 x Value) |
| HY | Hysteresis | Switching hysteresis for value I2 (Value HY applies to positive and negative hysteresis.) |
| D | Day | Day |
| I1 | Input 1 | 1st setpoint, comparison value |
| I2 | Input 2 | 2nd setpoint, comparison value |
| S | Setpoint | Setpoint, limit value |

8.5 Compatibility of the function relay parameters

The function relays of the easy400 and easy600 devices have been transferred to the easy500 and easy700 with enhanced functions. The parameter displays were adapted for the additional functions.

8.5.1 Parameter display of analog value comparator

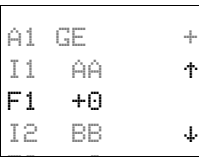
| | | | |
|---|------------------------------|---|---|
| | easy400, easy600 parameters | easy500, easy700 parameters | |
|  | AA BB A1 + ≥ | = I1 AA = I2 BB = A1 = + = GE |  |

8.5 Compatibility of the function relay parameters

8.5.2 Parameter display of counters

| | | | |
|--|---|---|--|
| | <p>easy400, easy600 parameters</p> <p>AAAA</p> <p>C1</p> <p>+</p> | <p>easy500, easy700 parameters</p> <p>= S AAAAA</p> <p>=</p> <p>= C1</p> <p>= +</p> | |
|--|---|---|--|

8.5.3 Parameter display of weekly timer

| | | | |
|--|---|---|--|
| | <p>easy400, easy600 parameters</p> <p>011</p> <p>AA-BB</p> <p>A</p> <p>ON ---:--</p> <p>OFF ---:--</p> <p>+</p> | <p>easy500, easy700 parameters</p> <p>= 011</p> <p>= AA-BB</p> <p>= A</p> <p>= ON ---:--</p> <p>= OFF ---:--</p> <p>= +</p> | |
|--|---|---|--|

8.5.4 Parameter display of timing relay

| | | | |
|--|--|--|--|
| | <p>easy400, easy600 parameters</p> <p>T1</p> <p>X</p> <p>S</p> <p>AA.BB</p> <p>+</p> | <p>easy500, easy700 parameters</p> <p>= T1</p> <p>= X</p> <p>= S</p> <p>= AA.BB</p> <p>= +</p> | |
|--|--|--|--|

8.5.5 Compatibility of memory cards

| Type of memory card | easy500 | | easy700 | |
|---------------------|---------|---------|---------|---------|
| | Reading | Writing | Reading | Writing |
| M-8K | ✓ | - | ✓ | - |
| M-16K | - | - | ✓ | - |
| M-32K | ✓ | ✓ | ✓ | ✓ |

8 Appendix

8.5 Compatibility of the function relay parameters

9 Glossary of terms

| | |
|-------------------------|---|
| Analog input | The device easy-AB, easy-DA and easy-DC are provided with the two (easy500) and four (easy700) analog inputs I7, I8 and I11,I12. The input voltages are between 0 V and 10 V. The measuring data is evaluated with the integrated function relays. |
| Output | You can connect various loads to the four easy outputs, such as contactors, lamps or and motors. In the easy circuit diagram the outputs are controlled via the corresponding output relay coils Q1 to Q8 or S1 to S8. |
| Operator buttons | easy has eight operating buttons. These are used to select menu functions and create circuit diagrams. The large round button in the middle is used to move the cursor. DEL, ALT, ESC and OK all perform additional functions. |
| Operating Mode | easy has two operating modes: RUN and STOP. RUN mode is used to process your circuit diagram (with the controller running continuously). In STOP mode you can create your circuit diagrams. |
| Remote expansion | I/O expansion with the expansion unit (e.g. EASY620-DC-TE) installed up to 30 m away from the basic unit. The EASY200-EASY coupling unit is fitted to the basic unit. The input and output data is exchanged between expansion and basic unit via a two-wire cable. |
| Entry mode | Entry mode is used to input or modify values. when creating circuit diagrams or setting parameters, for example. |
| Input | The inputs are used to connect up external contacts. In the circuit diagram, inputs are evaluated via contacts I1 to I12 and R1 to R12. easy-AB, easy-DA and easy-DC can also receive analog data via the inputs I7, I8 and I11, I 12. |
| Function Relays | Function relays can be used for complex control tasks. easy features the following function relays: <ul style="list-style-type: none"> • Timing relay, • Week time switch, • Year time-switch, • Counter, up/down, high-speed, frequency, • Analog value comparator/threshold value switch, • Operational time counter, • Master reset, • Text. |
| Contact behavior | The contact behavior of any circuit element can be defined as either a break contact or a make contact. Break contact elements are identified by a line above the identifier (Exception: jump). |
| Retentive data | See Retention. |
| Parameters | Parameters enable the user to set the behavior of function relays. The relevant parameters apply for switch times or counter setpoints. They are set in the parameter display. |

P Buttons

The P buttons can be used to simulate four additional inputs which are controlled directly by the four cursor buttons, rather than via external contacts. The switch contacts of P buttons are connected up in the circuit diagram.

Retention

Data is retained even after the easy relay power supply is switched off. (retentive data)

The following data is retentive:

- easy circuit diagram,
- Parameters, setpoint values,
- Texts,
- System settings,
- Password,
- Actual values of marker relays, timing relays, counters (selectable).

Circuit diagram elements

As in conventional wiring, the circuit diagram is made up of circuit elements. These include input, output and marker relays, plus function relays and P buttons.

Interface

The serial multifunction interface is used to exchange and save circuit diagrams to a memory card or PC.

Each memory card contains one circuit diagram and its associated easy settings.

The programming software easySoft-Basic or

easySoft -Pro programming software enables easy to be controlled from the PC. Which is connected using the easy-PC-CAB programming cable or EASY-USB-CAB.

Power supply

easy-AB is supplied with an 24 V AC supply. The terminals are labeled with "L" and "N".

easy-AC is powered by AC voltage at 85 to 264 V AC, 50/60 Hz. The terminals are labeled with "L" and "N".

easy-DA is powered by DC voltage at 12 V DC. The terminals are labeled "+12 V" and "0 V".

easy-DC is powered by DC voltage at 24 V DC. The terminals are labeled "+24 V" and "0 V".

The terminals for the power feed are the first three terminals on the input side.

Memory card

The memory card is used to store your easy circuit diagram, together with its parameter and easy settings. The data on the memory card will be retained, even if the power supply fails or is switched off.

The memory card is inserted into the interface slot on the easy device.

Rung

Each line in the circuit diagram is a rung. easy500 and easy700 can take 128 rungs.

| | |
|------------------------|---|
| Impulse relays | An impulse relay is a relay which changes its switching state and retains its new state (latched) when a voltage is applied to the relay coil for a short time. |
| Connect mode | Connect mode is used to wire up the circuit elements in your easy circuit diagram. |
| Local expansion | I/O expansion with the expansion unit (e.g. EASY620-DC-TE) installed directly on the basic unit. The connector is always supplied with the expansion unit. |

9 Glossary of terms

Index

A

| | |
|--|---------|
| Accuracy of real-time clock | 211 |
| Actual values, deleting retentive | 183 |
| Add rung | 55 |
| Analog | |
| Comparing two values | 93 |
| Input | 37, 227 |
| Input Power supply, Input | |
| analog, Power supply | 38 |
| Input, resolution | 86 |
| Setpoint potentiometer | 39 |
| Signals | 37 |
| Value comparator | 82 |
| value comparator parameter compatibility | 224 |
| Value comparator, two-step controller | 92 |
| AND circuit | 150 |
| Annual timer | 137 |
| Auxiliary Relay | 188 |
| Auxiliary relay | 72 |

B

| | |
|--|---------|
| Basic circuit | |
| Latching | 153 |
| Negation | 149 |
| Parallel circuit | 150 |
| Permanent contact | 149 |
| Series circuit | 150 |
| Break contact | 62, 222 |
| Bus system | 49 |
| Button | |
| ALT | 55 |
| DEL | 56 |
| OK | 54, 59 |
| Buttons for circuit diagram processing | 59 |

C

| | |
|-------------------------------|-----|
| Cable cross sections | 29 |
| Cable lengths | 34 |
| Cable protection | 29 |
| Cables | 29 |
| Card startup | |
| card | 180 |
| Change channel (annual timer) | 139 |
| Change channel (weekly timer) | 115 |
| Change language | 167 |
| Circuit Diagram | 60 |

Circuit diagram

| | |
|-----------------------------|--------------|
| Coil field | 64 |
| Contact fields | 64 |
| Controlling | 71 |
| Creation, troubleshooting | 204 |
| Cycle | 187 |
| Delete | 58 |
| Detection | 188 |
| Display | 54, 64 |
| easy operation | 188 |
| Elements | 228 |
| Enter | 52 |
| Fast entry | 58 |
| Function keys | 59 |
| Grid | 54, 64 |
| Internal processing | 187 |
| Load | 200 |
| load | 65, 195, 199 |
| Overview | 64 |
| Rung | 64 |
| Save | 198, 200 |
| save | 65, 195, 199 |
| Testing | 57, 71 |
| Wiring | 55, 68 |
| Circuit examples | 155 |
| Clock backup time | 211 |
| Coil | 61 |
| Coil field | 64 |
| Coil function | |
| Contactor | 73 |
| Impulse relay | 75 |
| Latching relay | 76 |
| Negate | 74 |
| Overview | 72 |
| Comparator functions | 83 |
| Comparison | |
| "Equal to" | 89 |
| "Greater than" | 91 |
| "Greater than/equal to" | 90 |
| "Less than" | 87 |
| "Less than/equal to" | 88 |
| Two analog values | 93 |
| Compatibility of parameters | 224 |
| Connect mode | 229 |

| | | | |
|--|--------|----------------------------------|-----------------|
| Connecting | | Counter | 94, 97, 98, 100 |
| 20 mA sensor | 40 | Cascading | 98 |
| Analog inputs | 37 | Component quantities | 97 |
| analog setpoint potentiometer | 39 | Counter frequency | 96 |
| Brightness sensor | 39 | fast, circuit diagram evaluation | 188 |
| Bus system | 49 | High-speed | 41, 103 |
| Contactors and relays | 42 | Maintenance | 120 |
| Digital input | 36 | Operating time/hours | 118 |
| Expansion | 28 | parameter compatibility | 225 |
| Frequency encoder | 41 | Retentive actual value | 99 |
| High-speed counters | 41 | Scan for actual value = zero | 99 |
| Input | 32 | Counter relay | 94 |
| Neon bulbs | 34 | Parameter set | 102, 105 |
| Output | 42 | Counter value automatic reset | 98 |
| Power supply | 29 | Counting unit quantities | 97 |
| Proximity switches | 36 | Current | |
| Pushbuttons and switches | 36 | Increasing input | 35 |
| Relay outputs | 42 | current | |
| Temperature sensor | 40 | Input | 33, 36, 37 |
| Transistor outputs | 44 | Cursor buttons | 15, 70 |
| Connecting brightness sensor | 39 | Activating | 177 |
| Connecting frequency encoders | 41 | Deactivating | 178 |
| Connecting setpoint potentiometer | 39 | see „P buttons“ | 228 |
| Connecting temperature sensor | 40 | Cursor display | 22, 59 |
| Connecting transistor output | 44 | Cycle | 187 |
| Connection cross sections | 29 | Cycle pulse | 74, 75, 154 |
| Connection of the L phase conductor and neutral conductor | 30 | D | |
| Connection type | 149 | Date setting | 170 |
| Connections | | Delay times | |
| Changing | 68 | for easy-AB, easy-DA, easy-DC | 191 |
| Creating | 68 | for easy-AC, easy-AB | 190 |
| Delete | 69 | Inputs and outputs | 189 |
| Position in the circuit diagram | 64 | of easy-DA and easy-DC | 189 |
| Contact | 61, 66 | Deleting retentive actual values | 183 |
| Behavior | 227 | Detecting operating states | 93 |
| Field | 64 | Device information | 185 |
| First | 55 | Device version | 202 |
| List all | 222 | Dimensions | 208 |
| Contactor function, invert | 74 | Display and operating unit | 202 |
| | | DST setting | 171 |

| | |
|--|---------------|
| E | |
| easy at a glance | 13 |
| geasy at a glance | 12 |
| easySoft | 65, 200 |
| easySoft-Basic | 65 |
| easySoft-Pro | 65 |
| Edge | |
| Evaluate falling | 74 |
| Evaluate rising | 75 |
| Falling | 154 |
| Rising | 154 |
| Electrical isolation, between basic device and expansion device | 47 |
| Electromagnetic compatibility (EMC) | 211 |
| Entry mode | 227 |
| Environmental Conditions | 210 |
| Error handling | |
| see „What happens If“ | 203 |
| expanding easy | 193 |
| Expansion | |
| Connecting | 28 |
| detecting | 193 |
| Local | 229 |
| monitoring | 194 |
| Remote | 227 |
| Transfer behavior | 194 |
| expansion | 193 |
| Expansion Devices | 46 |
| F | |
| Fixing brackets | 27 |
| Flashing | 132 |
| Frequency | 100 |
| Frequency counter | 100 |
| Function | 102 |
| Function block inputs, list of names | 224 |
| Function keys | 59 |
| Function relay | 100, 109, 118 |
| Counter | 94 |
| Example | 78 |
| High-speed counter | 103 |
| list | 222 |
| list of the names | 224 |
| Overview | 77 |
| Parameter | 169 |
| time switch | 137 |
| Timing relay | 122 |
| Function Relays | 60, 227 |
| Function relays | |
| List all | 223 |
| Master reset | 147 |
| Retention | 182 |
| Time switch | 113 |
| H | |
| High-speed counter | |
| Function | 106 |
| Hours-run meter | 118 |
| I | |
| Improper use | 9 |
| Impulse relay | 75 |
| Impulse relays | 154, 229 |
| Input | 227 |
| analog connecting | 37 |
| Analog resolution | 86 |
| Connecting | 32 |
| Contacts | 66 |
| Current | 35 |
| current | 33, 36, 37 |
| Debounce setting | 176 |
| Delay time | 189 |
| Digital connecting | 36 |
| Expanding | 46 |
| Response time | 194 |
| Terminals | 66 |
| Voltage range | 33, 36, 37 |
| Inrush current limitation | 35 |
| Installation | 25 |
| Insulation resistance | 211 |
| Interface | 196, 228 |
| Interference | 34 |
| Internal | 187 |
| invert | 68 |
| J | |
| Jumps | 135 |
| K | |
| Key to part numbers | 14 |
| Keypad | 15 |

| | | | |
|---|--------------|--|--|
| L | | | |
| Latching | 153 | | |
| Latching relay | 76 | | |
| LED display | 18 | | |
| List | | | |
| Contacts | 222 | | |
| Function relays | 223 | | |
| Relays | 223 | | |
| M | | | |
| Main menu | | | |
| overview | 18 | | |
| Selecting | 16 | | |
| Maintenance meter | 120 | | |
| marker | 72 | | |
| Marker reset | 148 | | |
| Master reset | 147 | | |
| Function | 148 | | |
| Memory card | 65, 197, 228 | | |
| Compatibility | 197 | | |
| delete | 199 | | |
| Fitting | 197 | | |
| read | 199 | | |
| write | 199 | | |
| Menu | | | |
| Change language | 167 | | |
| Changing level | 54 | | |
| Guidance | 15 | | |
| Language setting | 51 | | |
| Selecting main menu | 16 | | |
| Selecting System menu | 16 | | |
| Message | | | |
| INVALID PROG | 201, 204 | | |
| System | 203 | | |
| Mode | | | |
| Change | 57 | | |
| Monitoring expansion | 194 | | |
| Mounting | 26 | | |
| Screwing | 27 | | |
| Top-hat rail | 26 | | |
| N | | | |
| N/C contact | 61 | | |
| Invert | 68 | | |
| N/O contact | 61, 62, 222 | | |
| Invert | 68 | | |
| NAND circuit | 150 | | |
| Neon bulbs | 34 | | |
| Non-volatile data (retention) | 181 | | |
| NOT circuit | 149 | | |
| O | | | |
| Operating Mode | 227 | | |
| Operating modes | 52 | | |
| operating unit | 202 | | |
| Operation | 15, 59 | | |
| Operator buttons | 227 | | |
| OR circuit | 150 | | |
| Output | 227 | | |
| Connecting | 42 | | |
| Connecting relay | 42 | | |
| Connecting transistor | 44 | | |
| Contacts | 66 | | |
| Delay time | 189 | | |
| Expanding | 46 | | |
| Relay | 66 | | |
| reset | 148 | | |
| Response time | 194 | | |
| Overload | 46 | | |
| overload | | | |
| monitoring with EASY..-D.-T. | 192 | | |
| Overview | 10 | | |
| P | | | |
| P buttons | 228 | | |
| Activating | 177 | | |
| Activating and deactivating | 177 | | |
| Deactivating | 178 | | |
| see "Cursor buttons" | 70 | | |
| Parameter | | | |
| Block access | 168 | | |
| Change | 168 | | |
| Change switch time | 169 | | |
| Display | 168 | | |
| Function relay | 169 | | |
| power flow display | 80 | | |
| Parameter display | 60 | | |
| Timing relay | 102, 105 | | |
| Parameters | 227 | | |
| Compatibility | 224 | | |
| Password | | | |
| Activate | 165 | | |
| Changing | 166 | | |
| Deactivating, see "Unlock easy" | 165 | | |
| Deleting | 166 | | |
| Range | 164 | | |
| Remove protection | 167 | | |
| Set up | 164 | | |
| Password protection | 163 | | |
| Permissible markers and function relays | 182 | | |
| Placing into operation | 51 | | |

| | | | |
|--|---------------|--------------------------------------|----------|
| Power Flow Display | 57 | Rung | 228 |
| Power flow display | 71 | Add new | 55 |
| power flow display | 80 | Delete | 69 |
| Power supply | 29, 228 | Insert | 69 |
| Power supply, analog input | 38 | Running light | 159 |
| Program | 60 | S | |
| Proper use | 9 | scaled analog values | 109 |
| pulse shaping | 131 | Screw mounting | 27 |
| R | | Sensor (20 mA) | |
| Real-time clock backup time | 211 | Connecting | 40 |
| Real-time clock, accuracy | 211 | Set | 76 |
| Reed relay contacts | 34 | Setpoints | 169 |
| Relay | 60 | Setting summer time rule | 172 |
| Connecting output | 42 | Setting the cycle time | 181 |
| name | 66 | Settings | 163 |
| Number | 66 | Shift Register | 156 |
| Output, Technical data | 218 | Short-circuit | 46 |
| Overview | 63 | monitoring with EASY..-D.-T. | 192 |
| Timing | 122 | Signals, analog | 37 |
| relay | 66 | Stairwell lighting | 160 |
| Relay coil | | Star-delta starting | 155 |
| Changing | 66 | Startup behavior | 178, 180 |
| Coil function | 66, 72 | After deleting circuit diagram | 179 |
| Delete | 67 | Default setting | 179, 180 |
| Enter | 56 | Possible faults | 179 |
| Entering | 66 | Setting | 178 |
| Relays | | Upload/download to card or PC | 179 |
| Contactor function | 73 | Status image register | 187 |
| Impulse | 75 | Status indicator | 16, 17 |
| List all | 223 | Supply voltage | |
| Negate | 74 | Analog input | 38 |
| Reset | 76 | Switch contact | |
| Set | 76 | Cursor buttons | 70 |
| Reset | 76 | Switching contact | 68 |
| Reset counter value manually | 97 | Changing | 66 |
| Reset markers | 148 | Contact number | 66 |
| Reset, master | 147 | Contacting | 66 |
| Response time Input/output | 194 | Delete | 67 |
| Retention | 181, 182, 228 | Entering | 66 |
| memory | 211 | Invert | 55 |
| Retentive behavior | | Overview | 61 |
| Setting | 182 | switching contact | 66 |
| Transferring | 183 | Switch-on | 51 |
| Transferring the circuit diagram | 183 | System menu selection | 16 |
| RUN, start behavior | 52 | | |
| RUN/STOP switching | 57 | | |

| | | | |
|-----------------------------------|----------|--|------------|
| T | | V | |
| Target group | 9 | Value entry | 15 |
| Technical data | 210 | Versions | 12 |
| general | 210 | Voltage range, Input | 33, 36, 37 |
| Relay output | 218 | W | |
| transistor output | 220 | Week time switch | |
| Terminations | 29 | parameter compatibility | 225 |
| Text display | 109 | Weekday setting | 170 |
| Analog Value scaling | 110 | What happens If | 203 |
| Character set | 111 | Wiring | 59 |
| Entering a setpoint | 111 | Backwards | 188 |
| Text entry | 111 | Delete | 56 |
| Threshold switch | 82 | Enter | 55 |
| Tightening torque | 29 | Wiring rules | 73 |
| Time setting | 170 | X | |
| Time switch | 113 | XOR connection | 152 |
| annual | 137 | Y | |
| Change channel | 115, 139 | Year time switch | |
| examples | 115 | Behavior in the event of a power failure | 138 |
| Weekly | 113 | Configuring the parameters for | |
| Timeout Watchdog | 192 | continuous periods of time | 144 |
| Timing relay | 122 | Configuring the parameters for | |
| Flashing | 132 | recurring intervals | 142 |
| Off-delayed | 128 | Entry rules | 140 |
| On- and off-delayed | 129 | Sample parameter configurations | 115, 142 |
| On delayed | 127 | | |
| Operating modes | 124 | | |
| parameter compatibility | 225 | | |
| Pulse shaping | 131 | | |
| Time range | 125 | | |
| Top-hat rail | 26 | | |
| Transfer behavior Expansion | 194 | | |
| Transfer cable | 200 | | |
| Transistor output, Technical data | 220 | | |
| Troubleshooting | | | |
| During circuit diagram creation | 204 | | |
| With result | 205 | | |
| Two way circuit | | | |
| Changeover circuit | 152 | | |
| Two-step controller | 92 | | |
| Two-wire proximity switches | 35 | | |
| U | | | |
| Unlocking | 165 | | |
| use, improper | 9 | | |