

# GSA product catalog

furniture for technology workspaces



### Serving the U.S. government with quality products & services for over 35 years

Eaton has been providing world-class solutions for technology-intensive environments since 1934 and we've been a GSA Contract vendor for over 30 years.

### Support from concept to installation and beyond

Our project management team, which includes a dedicated design team, customer care team and technical sales experts, will see your project through from concept to installation and beyond.

### Design and technical expertise

Our design and technical experts will visit you on-site. We do the measuring, inventory your equipment, and determine the requirements necessary to meet your unique needs.

Next, our creative designers develop customized drawings to bring your workspace concepts to life, so you can visualize just how things will look once they are installed in your space.

### Certified installation support

Once the design is approved and the products are manufactured to your specifications, our project management team will schedule an installation plan that helps minimize disruption for your staff. Our certified installers arrive to take care of unpacking, assembling and arranging all of the equipment as well as coordinating technical integration with your on-site information systems teams.

### Service and support

For continued support, we provide services and extended warranties on all of our products. Simply contact your local Eaton sales representative for assistance.



*Complimentary 3-D CAD drawings and color renderings of your proposed solution.*

## GSA contract numbers

**Contract No: GS-03F-030DA**

**Schedule 71:**

Office Furniture

**SIN 711 2:**

Workstations, Computer Furniture & Accessories

**SIN 711 3:**

Filing & Storage Cabinets

**SIN 711 94:**

Design & Layout Services

**SIN 71310:**

Industrial & Institutional Furniture

**SIN 711 95:**

Installation Services

**Navy FISC Spiral III Blanket Purchase Agreement  
BPA No. N00189-17-A-0084**

**SIN 711 2:**

Workstations, Computer Furniture & Accessories

**SIN 711 3:**

Filing & Storage Cabinets





Tech Office

- OnGuard** command console..... 4-7
- Profile** advanced console system..... 8-11
- LMS** technical lab furniture ..... 12-13
- TechBench** workbench system ..... 14-17

General Office

- Compass** sit-to-stand modular desking system ..... 18-20
- Compass** modular desking system ..... 21-23
- LINX** modular office furniture ..... 24-27
- Optimedia** storage system..... 28-39
- Filing Companions** storage and filing accessories ..... 40
- TechCart** mobile furnishings..... 41-45



Data Center Solutions

- Paramount** enclosure system ..... 46-47

Options

- Seating** ..... 48-49
- Colors and finishes** ..... 50-52



Eaton reserves the right to make changes to the specifications, materials, equipment, prices, or the availability of products at any time without prior notice. While every effort has been made to assure the accuracy of information contained in this catalog at the time of publication, we cannot accept responsibility for inaccuracies resulting from undetected errors or omissions.

This catalog represents a small sampling of Eaton’s GSA product offering. Contact your local Eaton representative for more information.

Environmental sustainability

The following items hold the GREENGUARD Certification.\*

- Compass
- LMS
- Profile
- TechCart
- LINX
- Optimedia
- TechBench
- OnGuard

\*The GREENGUARD Certification Program is internationally recognized for evaluating product emissions that meet stringent indoor air quality criteria defined by GREENGUARD Environmental Institute (GEI). Products undergo rigorous, third-party testing to determine their impact on indoor air pollution with requirements for ongoing verification. Certified products are recommended for use by leading sustainable building programs including the U.S. Green Building Council’s (USGBC) Leadership in Energy and Environmental Design (LEED) Rating System.

## OnGuard Command Console

OnGuard



## OnGuard Command Console

OnGuard

### Superior performance, less downtime

Eaton’s high performance consoles keep your operations running smoothly — day after day, year after year.

The OnGuard™ command console is ideal for a multitude of technology-intensive environments including: public safety answering points (PSAPs), emergency operation centers (EOCs), network operation centers (NOCs), transportation management centers, process control, security and other monitoring and surveillance environments.



### Features & benefits

- Large single-surface lift
- Accommodates four to twelve 27" monitors
- Integrated cable lay-in features to help manage cables quickly and easily
- Expanded color options
- Customizable storage options
- Personal Environment System
- Designed and manufactured in U.S. facilities by tenured craftsmen and engineers
- Durable design withstands the rigors of a 24/7/365 multi-shift environment
- Features all steel construction, heavy-duty lifts and durable finish
- Eaton’s portfolio of ePDUs (*Power Distribution Units*), UPSs (*Uninterruptible Power Supply*), surge protectors and other power products ensure that your mission-critical operation runs at peak performance

### OnGuard command console

#### OnGuard command console dimensions

	Length (in)	Height (in)	Depth (in)
<b>Small</b>	120.66"	22"*	60.12"
<b>Medium</b>	133.66"	22"*	60.12"
<b>Large</b>	145.66"	22"*	60.12"

\*The worksurface height ranges from 22" (lowest) to 47.60" (highest)

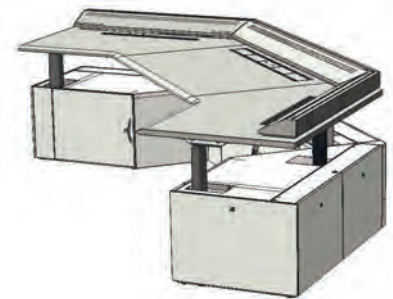



## OnGuard Command Console

OnGuard command consoles are designed to handle as few as four monitors and up to as many as twelve 27 inch monitors. The size of the units allow flexibility in monitor layouts as your business and technology changes.

### A. TechTrack

Located in the center of the worksurface, the TechTrack is a perfect spot for monitor placement. It houses the air vents for the optional Personal Environment System, and it can accommodate connective accessories such as USB, charging ports or data jacks.

### B. TechCurb

Allows for cables to be routed continuously around the perimeter of the workstation. Cables and power are conveniently accessed right at the desktop.

### C. Comfort edge

The front of the worksurface has an ergonomic urethane edge for maximum user comfort.

### D. Monitor pole track

The monitor pole track (located on the left and right sides of the worksurface), allows for monitor pole mounting based on your design. The patent-pending track facilitates optimal placement, and provides the flexibility to relocate in the future without causing damage to the worksurface.

### E. Lift technology

All OnGuard command consoles feature lifts to accommodate the varying heights of operators who share workstations, as well as provide sit-to-stand flexibility for users throughout their shift; promoting a healthier work environment.

### F. Steel or laminate base unit panels

OnGuard may be ordered with steel or laminate end and rear panels to complement the design of your work environment.

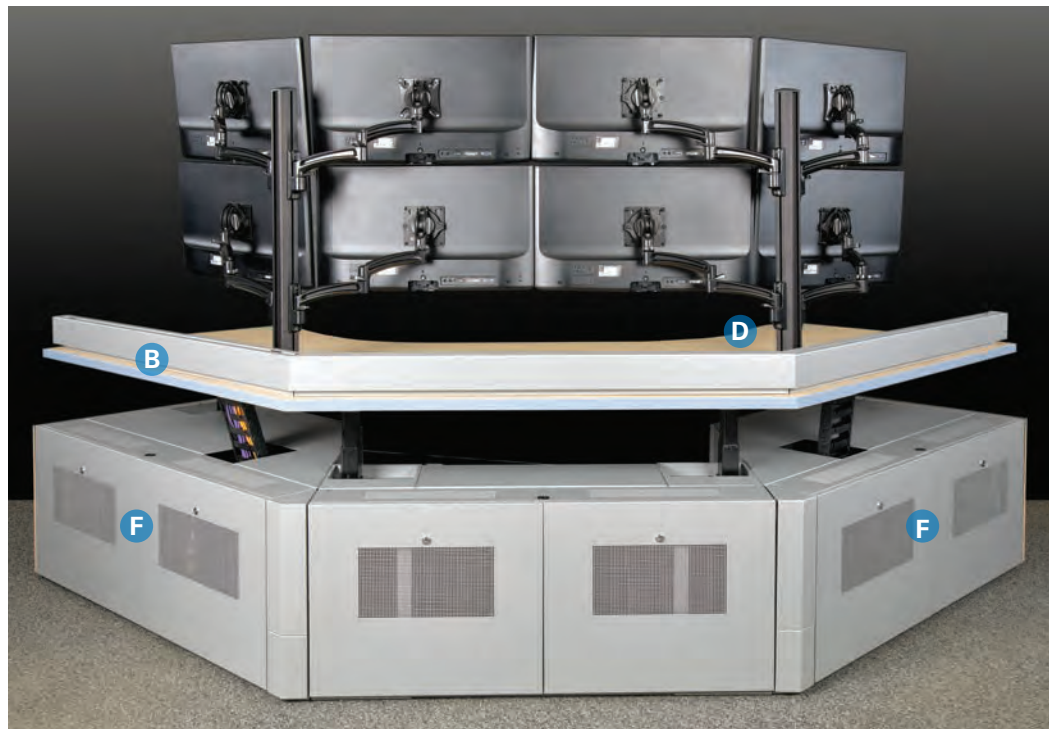

OnGuard Command Console

OnGuard

OnGuard command console – small

Item	Description	Qty.
<b>Configured</b>	<b>Small OnGuard unit</b>	
<b>AWS553DRM8F</b>	OnGuard console, 4 monitor wide base unit, steel rear panels, steel end panels, left 3 drawer storage, right rack mount storage, center personal environment storage, Freedom color collection	
<b>KONWLC20B</b>	20" Monitor mounting column & base plate kit	3
<b>KONWLK0B</b>	Pitch/pivot column head kit	
<b>KOWNWLK2B</b>	Articulating column arm kit	2



OnGuard command console – medium

Item	Description	Qty
<b>Configured</b>	<b>Medium OnGuard unit</b>	
<b>AWS56CP2D4P</b>	OnGuard console, 4 monitor wide base unit, steel rear panels, laminate end panels, left CPU storage, right 2 drawer storage, center CPU storage, Patriot color collection	
<b>KONWLC30B</b>	30" Monitor mounting column & base plate kit	2
<b>KONWLK2B</b>	Articulating arm kit	6



OnGuard command console – large

Item	Description	Qty
<b>Configured</b>	<b>Large OnGuard unit</b>	
<b>AWL66CPCP4L</b>	OnGuard console, 6 monitor wide base unit, laminate rear panels, laminate end panels, left CPU storage, right CPU storage, center CPU storage, Liberty color collection	
<b>KONWLC20B</b>	20" Monitor mounting column & base plate kit	3
<b>KONWLK2B</b>	Articulating column arm kit	6



## Profile Advanced Console System



Profile



## Profile Advanced Console System

Created specifically for high-density Flat Panel Display (FPD) monitoring applications, the Profile™ Console System features a versatile design that makes it ideal for a multitude of technology-intensive environments, including dispatch centers, network operation centers, medical imaging reading rooms, nurses stations and security stations.

### Features & benefits

- Offers advanced technology access and integrated cable management solutions
- Ultra-durable steel frame system designed to withstand the rigors of 7x24 environments
- Sophisticated, ergonomic console solutions that manage the convergence of today's technology and the human interface with which it integrates
- Perfect for applications where sit-to-stand accommodation is desired
- Single and dual electronic height-adjustable solutions, as well as manual height-adjustable keyboard platforms

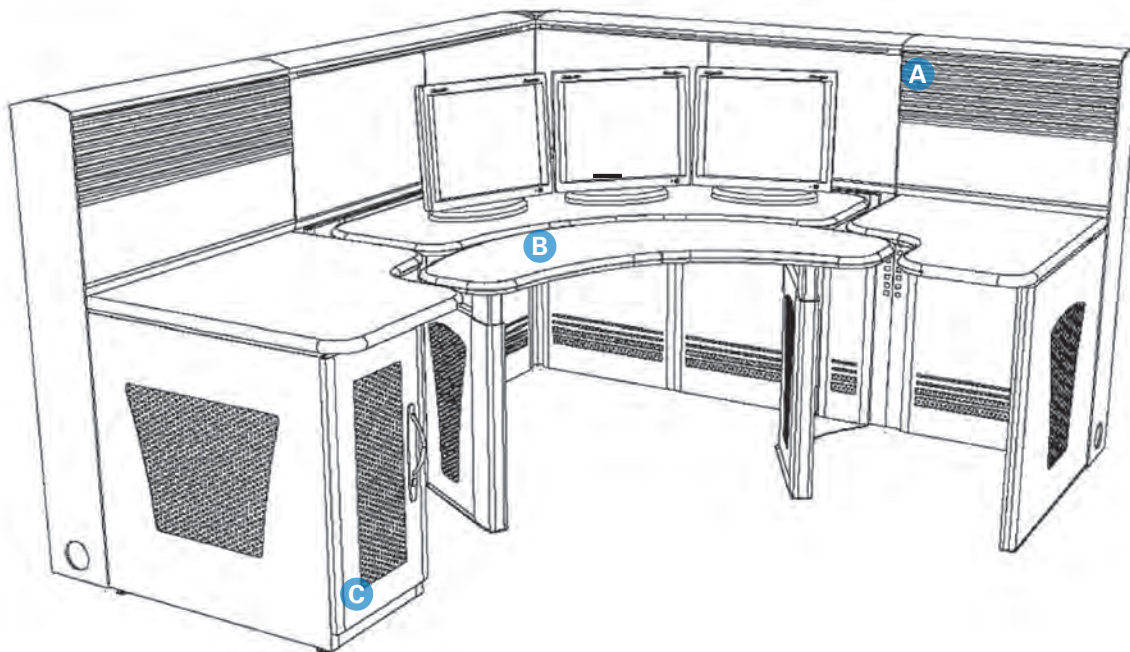

- A FPD integration** – aluminum extruded slatwall inserts allow mounting of FPDs and various filing accessories. The slatwall insert includes an easily removable panel to access interior cabling.
- B Electronic lifting worksurface** allows for an ergonomically correct operation. Available in dual or single lift or single lift with manual height-adjustable keyboard platform. Perfect for applications where sit-to-stand accommodation is desired.
- C High density technology storage** featuring ventilation perforations which help increase convection airflow. Front and rear access offers ease of service.

## Profile Advanced Console System

### 72" Linear station

Item	Description
<b>Configured</b>	<b>72"W x 30"D Linear control/communications station with 16"H flat panel mounting wall</b>
<b>PC7229S1</b>	72"W, Steel core, double sided
<b>PBW7230D</b>	72"W x 30"D Bullnose worksurface with rounded corners on left hand and right hand sides
<b>PCPR1428</b>	4"W x 28"D, CPU docker, right swing door with roll-out shelf
<b>PUPRFLH1</b>	30" Full depth left upright
<b>PCSK1000</b>	10" Removable steel skin
<b>PCSK2200</b>	22" Removable steel skin
<b>PCSK2400</b>	24" Removable steel skin
<b>PDW7216S</b>	72"W x 16"H Modular slatwall
<b>PDWT72S1</b>	72" Top trim
<b>PVET16T1C</b>	Vertical end trim with cable port (qty. 2)
<b>FPDARMWL9</b>	Adjustable FPD mount (qty. 2)

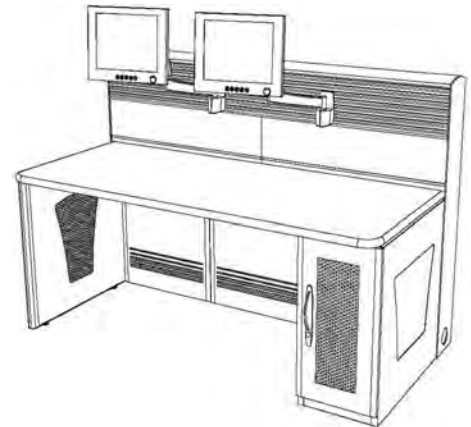

### 78" Dual lift corner station

Item	Description
<b>Configured</b>	<b>Ergonomic, dual lift, 78"W x 54"D corner control/communications station</b>
<b>PC2429S1</b>	24"W, Single-sided core
<b>PC3029S1</b>	30"W, Single-sided core
<b>PC4829S1</b>	48"W, Single-sided core (qty. 2)
<b>PEC48482</b>	48"W, 48"D Corner with dual electronic lift worksurfaces
<b>PCPR1428</b>	Single CPU docker with left swing door
<b>PCSK1400</b>	14" Removable skin
<b>PCSK2000</b>	20" Removable skin
<b>PCW2430R</b>	24"W x 30"D Curvilinear worksurface
<b>PCW3030L</b>	30"W x 30"D Curvilinear worksurface
<b>PDW2416S</b>	24"W x 16"D Modular slatwall
<b>PDW3016S</b>	30"W x 16"D Modular slatwall
<b>PMW4816S</b>	48"W x 16"D Modular wall (qty. 2)
<b>PDWT48S1</b>	48" Top trim (qty. 2)
<b>PDWT24S1</b>	24" Top trim
<b>PDWT30S1</b>	30" Top trim
<b>PET116P1</b>	90"D Corner wedge
<b>PUPRFLH1</b>	30" Full depth right upright
<b>PVET16T1C</b>	Tier 1 vertical end trim (qty. 2)
<b>PWFP2416</b>	24" Fabric insert (qty. 4)

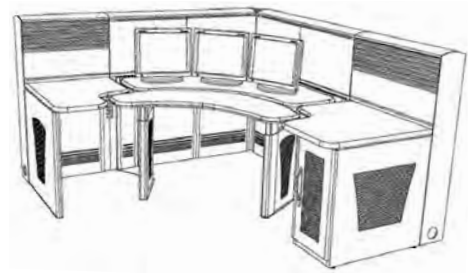



Profile Advanced Console System

102" Dual lift linear station

Item	Description
<b>Configured</b>	<b>Ergonomic, dual lift, 102"W x 30"D linear control/communications station</b>
<b>PBW3030D</b>	30"W x 30"D Bullnose worksurface
<b>PC3029S1</b>	30"W, Single-sided core
<b>PC7229S1</b>	72"W, Single-sided core
<b>PCPR1428</b>	Single CPU docker with right swing door
<b>PCSK1400</b>	14" Removable skin
<b>PDWT30S1</b>	30" Top trim
<b>PDWT72S1</b>	72" Top trim
<b>PDW3016S</b>	30"W x 16"H Modular slatwall
<b>PEWS72303</b>	72"W Linear dual lift
<b>PMW7216S</b>	72"W x 16"H Modular slatwall
<b>PVET16T1C</b>	Tier 1 vertical end trim (qty. 2)
<b>PWFP3616</b>	24" Fabric insert (qty. 2)
<b>PUPRSLH1</b>	30"D Cantilever top support left

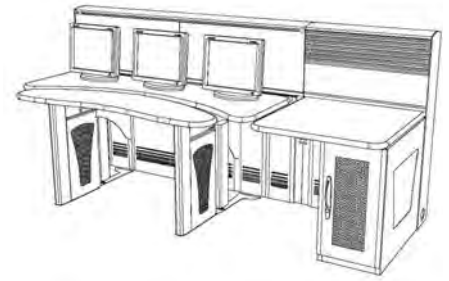

Profile

## LMS Technical Lab Furniture

LMS





LMS Technical Lab Furniture

Eaton’s modular LMS™ furniture provides the highly efficient design and configuration capabilities required in today’s lab environments. Specializing in the integration of people, technology, workspace and workflow, Eaton’s approach to building effective and efficient laboratories encompasses four basic principles:

- Ergonomic workspace
- Technology integration
- Modular configuration
- Vertical space utilization



Computer/graphics stations

Configured	LMS 1 – 36" wide
7L07	72" Upright, 31"D (qty.2)
7LG1	72" X 36" Full frame
MG19	36" Mobile base, 31"D
LG32	36" Worksurface, 27"D
LG25	36" Tower shelf/11.9"
LG26	36" Tower add-on shelf
KBTRY18	Keyboard platform with sliding mouse tray
LG33	36" Horizontal cable management kit (qty. 2)

Configured	LMS 2 – 48" wide
7L07	72" Upright, 31"D (qty. 2)
7LE1	72" X 48" Full frame
ME19	48" Mobile base, 31"D
LE32	48" Worksurface, 27"D
LE25	48" Tower shelf/11.9"
LE26	48" Tower add-on shelf
KBTRY18	Keyboard platform with sliding mouse tray (qty. 2)
LE33	48" Horizontal cable management kit (qty. 2)

Configured	LMS 3 – 72" wide
7L07	72" Upright, 31"D (qty. 2)
7LF1	72" X 72" full frame, (3) 24" modules
LF19	72" Standard caster base
LF32	72" Hook-on worksurface
LF25	72" Tower shelf/11.9"
LF26	72" Tower add-on shelf
LF33	72" Horizontal cable management kit (qty. 2)
KBTRY18	Keyboard platform with sliding mouse tray (qty. 3)

Configured	LMS 4 – 84" wide
8LH1	84"W x 72"H Modular full frame
8L27	84"H Uprights (qty. 2)
LF32	72"W x 36"H Worksurface with cantilevers
MG07	48"W x 18"H Hook-on laminate shelves (qty. 4)

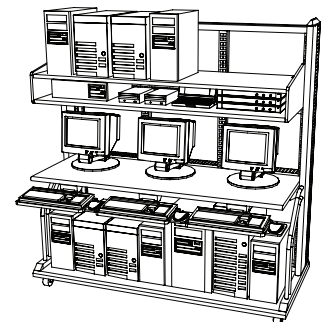
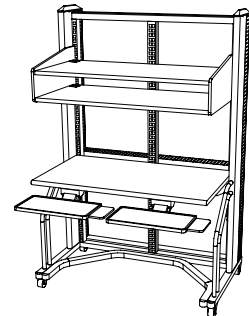
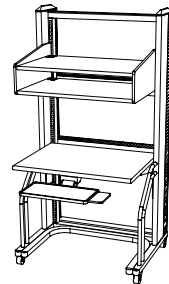

## TechBench Workbench System



TechBench



## TechBench Workbench System

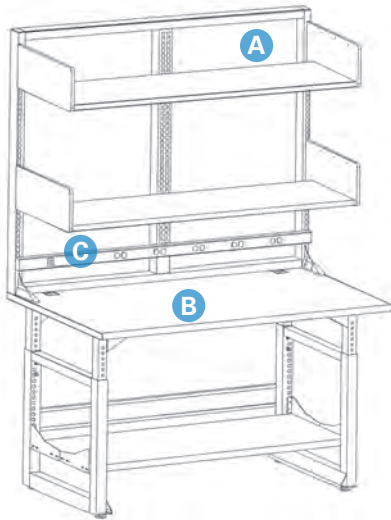

**A** Strong, durable, modular steel TechOrganizer allows for a myriad of desktop and overhead storage accessories and options. Helps to keep work surfaces clear and contributes to proper 'lean' lab management principles.

**B** Worksurfaces are available in high-pressure laminate, phenolic resin and maple hardwood.

**C** Integrated modular power and data distribution solutions are available.

### Features & benefits

- Strength and durability required in today's instrumentation chemistry applications
- Optional components for space management and storage for analytical instrumentation and supplies
- Flexible solutions for flat panel displays, computers, keyboards, power, and data
- Height configurable from desk to workbench height
- Available in 24" to 96" widths and 30" and 36" worksurface depths
- Multiple worksurface materials are available

### Linear TechBench (laminate worksurface)

Item	Description
<b>TBLW7236A</b>	72"W x 36"D TechBench with laminate worksurface
<b>TBLW6036A</b>	60"W x 36"D TechBench with laminate worksurface
<b>TBLW4836A</b>	48"W x 36"D TechBench with laminate worksurface
<b>TBLW3636A</b>	36"W x 36"D TechBench with laminate worksurface

### Linear TechBench (maple worksurface)

Item	Description
<b>TBMW7236A</b>	72"W x 36"D TechBench with solid maple worksurface
<b>TBMW6036A</b>	60"W x 36"D TechBench with solid maple worksurface
<b>TBMW4836A</b>	48"W x 36"D TechBench with solid maple worksurface
<b>TBMW3636A</b>	36"W x 36"D TechBench with solid maple worksurface

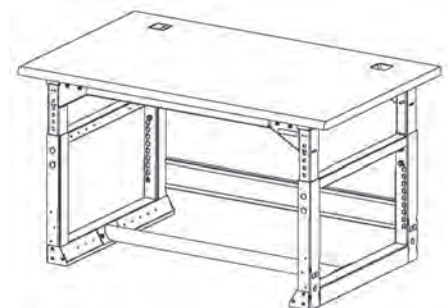

## TechBench Workbench System

### Configured linear TechBench - 48" wide

Item	Description
<b>Configured</b>	<b>48"W x 36"D TechBench with 48" TechOrganizer and shelving</b>
<b>TBLW4836A</b>	48"W x 36"D TechBench with laminate worksurface
<b>TBAFS4822</b>	Adjustable full shelf
<b>TF48481</b>	48"W x 48"H TechOrganizer
<b>LE21</b>	48" Electronic shelf (qty. 2)



### Configured linear TechBench - 72" wide

Item	Description
<b>Configured</b>	<b>72" Wide configured TechBench</b>
<b>TBLW7230A</b>	72"W X 30"D Linear TechBench with laminate top
<b>TBAPS7212</b>	72" Partial shelf
<b>TF48721</b>	48"H Linear TechOrganizer, 72"W
<b>BLS7218</b>	72" Laminate shelf, 18"D
<b>TWB1924</b>	19"H White board, 24"W
<b>MB40</b>	24" Small bin rail (qty. 3)
<b>TPB3624</b>	36"H Peg board, 24"W
<b>C98009</b>	3" Akro-bins (case of 24), yellow
<b>C830MM</b>	(6"/12") Suspended pedestal
<b>TBFACP1530</b>	Fixed accessory plate

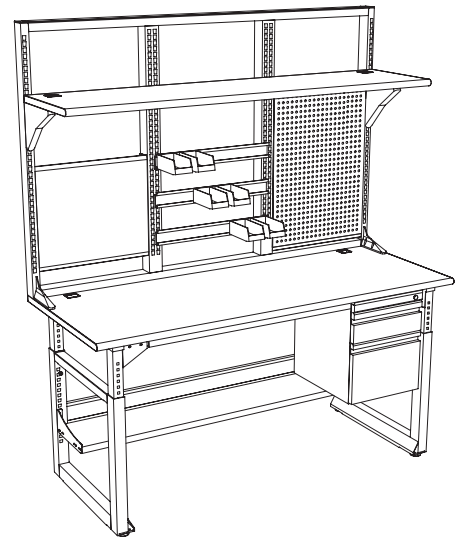

### Configured linear TechBench - 72" wide with storage cabinet

Item	Description
<b>Configured</b>	<b>72" Wide configured TechBench</b>
<b>TBLW7230A</b>	72"W X 30"D Linear TechBench with laminate top
<b>TF48721</b>	48"H Linear TechOrganizer, 72"W (24")
<b>BLS7218</b>	72" Plus laminate shelf, 18"D
<b>TWB1924</b>	19"H White board, 24"W
<b>MB40</b>	24" Small bin rail (qty. 3)
<b>TPB3624</b>	36"H Peg board, 24"W
<b>C98009</b>	3" Akro-bins (case of 24), yellow
<b>UM72MM</b>	Optimedia caster base, 36"W
<b>1M41</b>	28" Under bench optimedia cabinet preconfigured with (4) 6" drawers

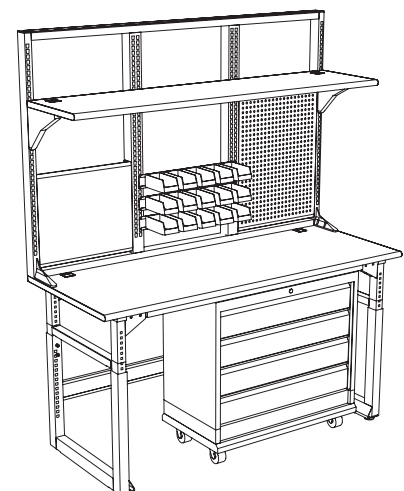



## TechBench Workbench System

### Configured linear TechBench - 48" wide

Item	Description
<b>Configured</b>	<b>48" Wide configured TechBench</b>
<b>TBLW4830A</b>	48"W X 30"D Linear TechBench with laminate top
<b>TF48481</b>	48"H Linear TechOrganizer, 48"W
<b>TPB3624</b>	36"H Peg board, 24"W
<b>TBB3224</b>	32"H Bin board, 24"W
<b>BLS4818</b>	48" Plus laminate shelf, 18"D
<b>C845</b>	Box/box/file mobile pedestal
<b>C98009</b>	3" Akro-bins (case of 24), yellow

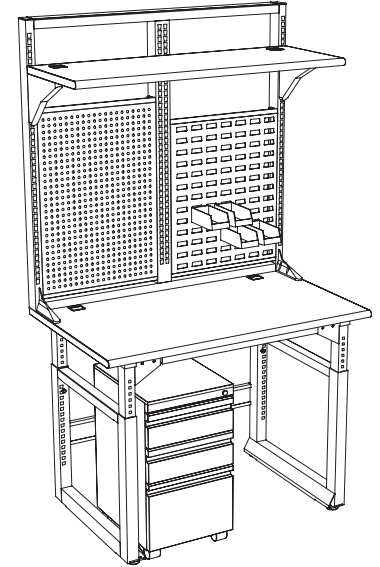

### Linear TechBench accessories

Item	Description
<b>TBHDC0558</b>	Heavy-duty caster kit (includes set of 4 casters)
<b>TBFT4800A</b>	Foot rest tube



TechBench

*A full line of analytical lab furniture is available.  
Contact your local account representative for pricing.*

## Compass Sit-to-Stand Modular Desking System



Compass  
sit-to-stand

## Compass Sit-to-Stand Modular Desking System

Eaton’s Compass™ modular desking system now includes a new sit-to-stand option. This height-adjustable workstation allows the freedom to sit or stand while working. The Compass sit-to-stand offers all the features of the classic Compass line, including a freestanding, steel-based design that exceeds industry requirements for strength and durability.

Its modularity permits unlimited configuration possibilities to reflect the work styles of your people in open or private office settings. It is completely scalable and reconfigurable. And, contemporary worksurface designs with multiple options for finishes and fabrics ensure a high-end aesthetic appeal.

### Features & benefits

- Flexible, durable and adjustable
- Customizable and scalable
- Technology integration
- Ergonomics and comfort with Compass sit-to-stand options
- Contemporary designs with multiple finish and fabric choices
- Modular design allows unlimited reconfigurability
- Slim profile maximizes valuable office space
- Ideal for both private and open office configurations



### Free standing linear

Item	Description
<b>Configured</b>	<b>Linear free standing workstation</b>
<b>CWFSS4824</b>	Linear free standing 48 x 24
<b>CWFSS4830</b>	Linear free standing 48 x 30
<b>CWFSS6024</b>	Linear free standing 60 x 24
<b>CWFSS6030</b>	Linear free standing 60 x 30
<b>CWFSS7224</b>	Linear free standing 72 x 24
<b>CWFSS7230</b>	Linear free standing 72 x 30



### Integrated linear

Item	Description
<b>Configured</b>	<b>Linear workstation</b>
<b>CWSS4824</b>	Linear integrated – 48 x 24
<b>CWSS4830</b>	Linear integrated – 48 x 30
<b>CWSS6024</b>	Linear integrated – 60 x 24
<b>CWSS6030</b>	Linear integrated – 60 x 30
<b>CWSS7224</b>	Linear integrated – 72 x 24
<b>CWSS7230</b>	Linear integrated – 72 x 30



Compass  
sit-to-stand



## Compass Sit-to-Stand Modular Desking System

### Free standing corner

Item	Description
<b>Configured</b>	<b>Corner workstation</b>
<b>CWFSS48481</b>	Corner free standing – 48 x 48 – 24 deep
<b>CWFSS48482</b>	Corner free standing – 48 x 48 – 30" deep
<b>CWFSS4848L</b>	Corner free standing – 48 x 48 – 30L/24R
<b>CWFSS4848R</b>	Corner free standing – 48 x 48 – 24L/30R
<b>CWFSS48601</b>	Corner free standing – 48 x 60 – 24/24
<b>CWFSS48602</b>	Corner free standing – 48 x 60 – 30/30
<b>CWFSS4860L</b>	Corner free standing – 48 x 60 – 30L/24R
<b>CWFSS4860R</b>	Corner free standing – 48 x 60 – 24L/30R
<b>CWFSS48721</b>	Corner free standing – 48 x 72 – 24/24
<b>CWFSS48722</b>	Corner free standing – 48 x 72 – 30/30
<b>CWFSS4872L</b>	Corner free standing – 48 x 72 – 30L/24R
<b>CWFSS4872R</b>	Corner free standing – 48 x 72 – 24L/30R
<b>CWFSS60481</b>	Corner free standing – 60 x 48 – 24/24
<b>CWFSS60482</b>	Corner free standing – 60 x 48 – 30/30
<b>CWFSS6048L</b>	Corner free standing – 60 x 48 – 30L/24R
<b>CWFSS6048R</b>	Corner free standing – 60 x 48 – 24L/30R
<b>CWFSS72481</b>	Corner free standing – 72 x 48 – 24/24
<b>CWFSS72482</b>	Corner free standing – 72 x 48 – 30/30
<b>CWFSS7248L</b>	Corner free standing – 72 x 48 – 30L/24R
<b>CWFSS7248R</b>	Corner free standing – 72 x 48 – 24L/30R
<b>CWFSS72722</b>	Corner free standing – 72 x 72 – 30/30



### Integrated corner

Item	Description
<b>Configured</b>	<b>Corner workstation</b>
<b>CWSS48481</b>	Corner integrated – 48 x 48 – 24" deep
<b>CWSS48482</b>	Corner integrated – 48 x 48 – 30" deep
<b>CWSS4848L</b>	Corner integrated – 48 x 48 – 30L/24R
<b>CWSS4848R</b>	Corner integrated – 48 x 48 – 24L/30R
<b>CWSS48601</b>	Corner integrated – 48 x 60 – 24/24
<b>CWSS48602</b>	Corner integrated – 48 x 60 – 30/30
<b>CWSS4860L</b>	Corner integrated – 48 x 60 – 30L/24R
<b>CWSS4860R</b>	Corner integrated – 48 x 60 – 24L/30R
<b>CWSS48721</b>	Corner integrated – 48 x 72 – 24/24
<b>CWSS48722</b>	Corner integrated – 48 x 72 – 30/30
<b>CWSS4872L</b>	Corner integrated – 48 x 72 – 30L/24R
<b>CWSS4872R</b>	Corner integrated – 48 x 72 – 24L/30R
<b>CWSS60481</b>	Corner integrated – 60 x 48 – 24/24
<b>CWSS60482</b>	Corner integrated – 60 x 48 – 30/30
<b>CWSS6048L</b>	Corner integrated – 60 x 48 – 30L/24R
<b>CWSS6048R</b>	Corner integrated – 60 x 48 – 24L/30R
<b>CWSS72481</b>	Corner integrated – 72 x 48 – 24/24
<b>CWSS72482</b>	Corner integrated – 72 x 48 – 30/30
<b>CWSS7248L</b>	Corner integrated – 72 x 48 – 30L/24R
<b>CWSS7248R</b>	Corner integrated – 72 x 48 – 24L/30R



Compass sit-to-stand

## Compass Modular Desking System

The perfect combination for your ideal work environment. It all starts with Compass' construction – a freestanding, steel-based design that exceeds industry requirements for strength and durability. Its modularity permits unlimited configuration possibilities to reflect the work styles of your people in open or private office settings. It is completely scalable and reconfigurable. And, contemporary worksurface designs with multiple options for finishes and fabrics ensure a high-end aesthetic appeal.



### Features & benefits

- Contemporary designs with multiple finish and fabric choices
- Modular design allows unlimited reconfigurability
- Slim profile maximizes valuable office space
- Ideal for both private and open office configurations

### Compass L-shaped corner workstation 6' x 8'

Item	Description
<b>Configured</b>	<b>L-shaped corner workstation</b>
<b>CDS48C</b>	Locking Compass door 48"W corner
<b>CDS48L</b>	Locking Compass door 48"W linear
<b>CLC29</b>	Corner upright 29"H
<b>CLCS48C</b>	Locking compartment 48" corner
<b>CLCS48L</b>	Locking compartment 48" linear
<b>CLF2429L</b>	Full depth leg 24"D x 29"H left
<b>CLF3029R</b>	Full depth leg 30"D x 29"H right
<b>CLLT3029</b>	Linked transition upright 30"D x 29"H
<b>CM48C</b>	48"W Modesty panel corner
<b>CM48L</b>	48"W Modesty panel linear
<b>CM72C</b>	72"W Modesty panel corner
<b>COFJ4820C</b>	Fabric panel 48"W x 20"H J hook corner
<b>COFJ4820L</b>	Fabric panel 48"W x 20"H J hook linear
<b>COU36</b>	Organizer upright 36"H (qty. 2)
<b>CWCT7248R</b>	72" x 48" Corner WS 24"D transition
<b>CWL4830</b>	48"W x 30"D WS linear

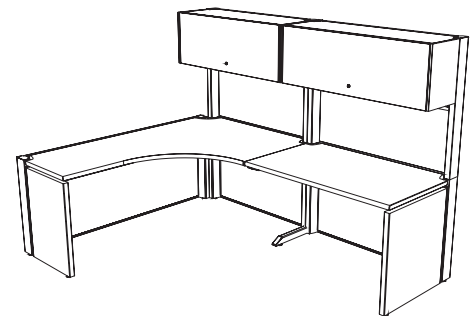

Compass

## Compass Modular Desking System

### Compass Corner workstation 7' x 7'

Item	Description
<b>Configured</b>	<b>Corner workstation</b>
<b>CDF36L</b>	Locking Compass door fabric panel 36"W linear (qty. 2)
<b>CLC65</b>	Corner upright 65"H
<b>CLC36L</b>	Locking Compass 36"W linear (qty. 2)
<b>CLS2465L</b>	Standard upright 24"D x 65"H left
<b>CLS2465R</b>	Standard upright 24"D x 65"H right
<b>CM36L</b>	Modesty panel 36"W linear (qty. 2)
<b>CM48C</b>	Modesty panel 48"W corner (qty. 2)
<b>COFJ3620L</b>	36"W x 20"H Fabric panel J hook corner (qty. 2)
<b>COFJ4816C</b>	48"W x 16"H Fabric panel J hook corner (qty. 2)
<b>COFJ4820C</b>	48"W x 20"H Fabric panel J hook corner (qty. 2)
<b>CSL4848</b>	48" x 48" Corner shelf
<b>CWC48481</b>	48" x 48" Corner 24"D WS
<b>CWL3624</b>	36"W 24"D WS linear (qty. 2)
<b>CLT2465L</b>	Transitional upright 24"D x 65"H left (qty. 2)
<b>CLS2465R</b>	Transitional upright 24"D x 65"H right (qty. 2)

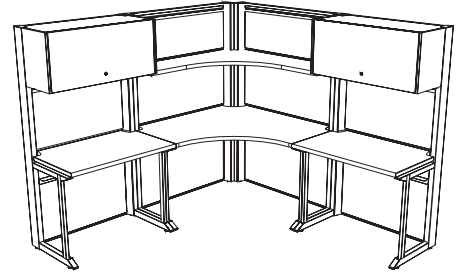

### Compass linear workstation 6'

Item	Description
<b>Configured</b>	<b>Linear workstation</b>
<b>CDS60L</b>	60" Linear Compass door steel
<b>CLCS60L</b>	60"W Linear locking compartment
<b>CLS3029L</b>	Standard leg 30"D x 29"W left
<b>CLS3029R</b>	Standard leg 30"D x 29"W right
<b>COFJ6020L</b>	Fabric panel 50"W x 20"H linear
<b>COU36</b>	Organizer upright, 36"H
<b>CWL6030</b>	60"W x 30"D linear WS

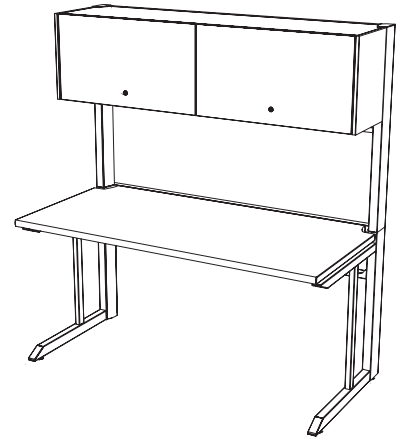



## Compass Modular Desking System

### Compass u-shaped conference end workstation 8' x 8' right

Item	Description
<b>Configured</b>	<b>U-shaped workstation right</b>
<b>CDC48L</b>	Locking Compass door 48"W linear
<b>CLC29</b>	Corner upright 29"H
<b>CLCS48L</b>	Locking compartment 48" linear
<b>CLF1829R</b>	Full depth leg 18"D x 29"H right
<b>CLF2429L</b>	Full depth upright 24"D x 29"H left
<b>CLLT2429</b>	Linked transition upright 24"D x 29"H (qty. 2)
<b>COF4816C</b>	Fabric panel 48"W x 16"H corner
<b>COF4820C</b>	Fabric panel 48"W x 20"H corner
<b>COF4820L</b>	Fabric panel 48"W x 20"H linear
<b>COFJ3616L</b>	Fabric panel 36"W x 16"H linear J hook
<b>COFJ4816C</b>	Fabric panel 48"W x 16"H linear J hook
<b>COU16</b>	Organizer upright 16"H (qty. 2)
<b>COU36</b>	Organizer upright 36"H (qty. 2)
<b>CSL48C</b>	48"W Linear shelf corner WS
<b>CWC48481</b>	48" x 48" corner WS 24"D
<b>CWJ48721R</b>	Jetty WS 48" x 72", 24"D right
<b>CWL4824</b>	48"W x 24"D WS linear

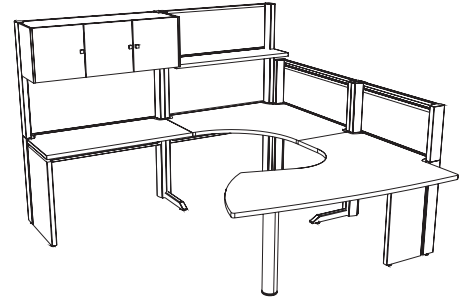

### Compass u-shaped conference end workstation 8' x 8' left

Item	Description
<b>Configured</b>	<b>U-Shaped workstation left</b>
<b>CDC48L</b>	Locking Compass door 48"W linear
<b>CLC29</b>	Corner upright 29"H
<b>CLCS48L</b>	Locking compartment 48" linear
<b>CLF1829L</b>	Full depth leg 18"D x 29"H left
<b>CLF2429R</b>	Full depth upright 24"D x 29"H right
<b>CLLT2429</b>	Linked transition upright 24"D x 29"H (qty. 2)
<b>COF4816C</b>	Fabric panel 48"W x 16"H corner
<b>COF4820C</b>	Fabric panel 48"W x 20"H corner
<b>COF4820L</b>	Fabric panel 48"W x 20"H Linear
<b>COFJ3616L</b>	Fabric panel 36"W x 16"H linear J hook
<b>COFJ4816C</b>	Fabric panel 48"W x 16"H Linear J hook
<b>COU16</b>	Organizer upright 16"H (qty. 2)
<b>COU36</b>	Organizer upright 36"H (qty. 2)
<b>CSL48C</b>	48"W Linear shelf corner WS
<b>CWC48481</b>	48" x 48" Corner WS 24"D
<b>CWJ48721L</b>	Jetty WS 48" x 72", 24"D left
<b>CWL4824</b>	48"W x 24"D WS linear

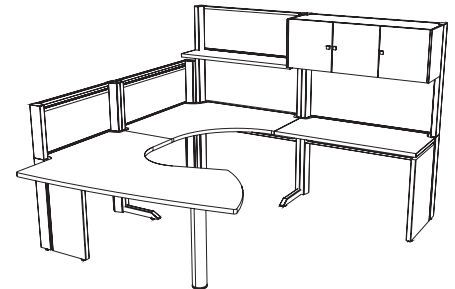

## LINX Modular Office Furniture



## LINX Modular Office Furniture

LINX™ modular furniture is a freestanding technical desking platform, that gives you and your facility planners the ultimate flexibility in creating a space efficient office layout.

### Features & benefits

- Free-standing technical desking platform with detachable storage walls provides the ultimate in flexibility
- Reconfigurable system adapts to meet your needs
- Provides a universal platform for multiple modular technology applications
- Distinct monitor technology integration
- Integrated vertical and horizontal cable management
- Perfect for the private office, open team workstations, conferencing and training





## LINX Modular Office Furniture



### LINX 6' linear workstation

Item	Description
<b>Configured</b>	<b>6' Linear workstation</b>
<b>WT7230F29</b>	72" x 30" LINX top
<b>WLSU2930</b>	29"H x 30"D Left standard upright
<b>WRSU2930</b>	29"H x 30"D Right standard upright
<b>C845</b>	Box/box/file mobile pedestal
<b>C846</b>	File/file mobile pedestal
<b>KBTRY18</b>	Adjustable keyboard tray



Shown with optional CPU caddy.

### LINX linear workstation with separate conference desk

Item	Description
<b>Configured</b>	<b>U-shaped workstation</b>
<b>WT7224F29</b>	72" x 24" LINX top
<b>WLFU2924</b>	29"H x 24"D Left full upright
<b>WRFU2924</b>	29"H x 24"D Right full upright
<b>WTBW72F29</b>	72" x 36" Bow top
<b>WLFU2930</b>	29"H x 30"D Left full upright
<b>WRFU2930</b>	29"H x 30"D Right full upright
<b>W417205</b>	72" Organizer 41"H with fabric doors
<b>C847</b>	LINX utility drawer
<b>KBTRY18</b>	Adjustable keyboard tray
<b>W168</b>	48" Task light for shelving

### LINX corner workstation

Item	Description
<b>Configured</b>	<b>Corner workstation</b>
<b>WT3624F29</b>	36" x 24" LINX top
<b>WLFU2924</b>	29"H x 24"D Left full upright
<b>WRTU2919</b>	29"H x 19"D Right transitional upright
<b>WT7230F29</b>	72" x 30" LINX top
<b>WLFU2930</b>	29"H x 30"D Left full upright
<b>WRFU2930</b>	29"H x 30"D Right full upright
<b>W367205</b>	72" Organizer 36"H with fabric
<b>W168</b>	48" Task light for shelving
<b>WD72</b>	72" Overhead laminate shelf
<b>C846</b>	File/file mobile pedestal
<b>C857</b>	Keyboard bridge
<b>W150</b>	Right slanted sorter file (qty. 2)



**LINX Modular Office Furniture**



Shown with optional Optimedia cabinet.

**LINX corner workstation with curved jetty**

Item	Description
<b>Configured</b>	<b>Corner workstation with curved jetty</b>
<b>WFC722F29</b>	48" Right x 72" left freestanding curved corner top
<b>WLFU2924</b>	29"H x 24"D Left full upright
<b>WRTU2919</b>	29"H x 19"D Right transitional upright
<b>WJ2R48F29</b>	Right jetty top (24" side)
<b>WLTU2919</b>	29"H x 19"D Transitional upright
<b>WRFU2924</b>	29"H x 24"D Right full upright
<b>W507205</b>	72" Organizer, 50"H with fabric doors
<b>W168</b>	48" Task light for shelving
<b>C845</b>	Box/box/file mobile pedestal
<b>KONWL11D</b>	FPD arm

**LINX team workstation**



Item	Description
<b>Configured</b>	<b>Team workstation</b>
<b>WFC723F29</b>	48" Left x 72" right freestanding curved corner
<b>WLSU2930</b>	29"H x 30"D Left standard upright
<b>WRTU2919</b>	29"H x 19"D Right transitional upright
<b>WBP721F29</b>	72" x 30" Bolt-on peninsula top
<b>WFC724F29</b>	48" Right x 72" left freestanding curved corner
<b>WLTU2919</b>	29"H x 19"D Left transitional upright
<b>WRSU2930</b>	29"H x 30"D Right standard upright
<b>W348722</b>	48" x 72" Corner organizer with four fabric panels (36"H) (qty. 2)
<b>WS4872L</b>	48" Left x 72" right curved corner shelf left
<b>WS4872R</b>	48" Right x 72" left curved corner shelf right
<b>W363005</b>	30" Organizer 36"H with fabric
<b>W160</b>	24" Task light for 30" shelving (qty. 3)



**LINX bullet conference tables**

Item	Description	Dimensions
<b>W990</b>	48" Bullet conference	29"H x 48"W x 36"D
<b>W992</b>	60" Bullet conference	29"H x 60"W x 36"D
<b>W993</b>	72" Bullet conference	29"H x 72"W x 36"D
<b>W994</b>	84" Bullet conference	29"H x 84"W x 36"D
<b>W995</b>	96" Bullet conference	29"H x 96"W x 36"D



## Optimedia Storage System

Optimedia





## Optimedia Storage System

Optimedia

### Optimedia specifications

The Optimedia™ product line includes five core cabinet types with many interchangeable storage components that are easy to remove and reconfigure.

- Sidewinder™ tambour cabinets feature side opening tambour doors
- Classic tambour cabinets have front-to-back receding tambour doors
- Partial tambour cabinets offer a combination closure, with a classic tambour door at the top, and modular steel drawers at the bottom
- Extra-deep cabinets with high-capacity storage (24" deep footprint)

### Cabinet construction and specifications

- Heavy gauge steel, fully welded and reinforced
- Top, sides, back panels and uprights are manufactured of 20-gauge cold-rolled steel (CRS)
- Bottom is 18-gauge CRS
- All side seams are hidden for a smooth, finished appearance
- Shell includes four (4) welded internal uprights at corners of cabinet body, slotted at 1/4" intervals for four post support of storage components
- Shell equipped with advanced safety interlocks which help prevent two roll-outs from being pulled out simultaneously\* †
- Includes removable core lock for security.
- Options for individually keyed cabinets available.

\*Cabinets with extra-deep shells do not include this feature

† Applies to configurations using multiple roll-out components

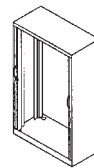

A - Sidewinder tambour

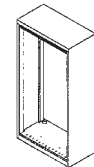

B - Classic tambour

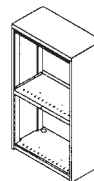

C - Partial tambour

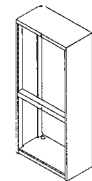

D - Door/drawer

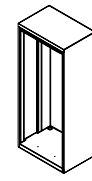

E - Extra-deep

## Optimedia Storage System Modular Drawer Cabinets

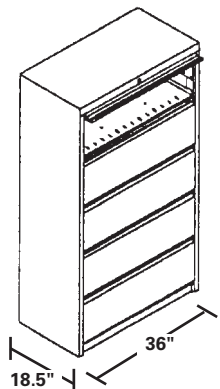

**A** Removable core lock is keyed and controls ganglock to secure all doors and drawers.

**B** Modular drawer. Typically used for storage or for drop filing.

### Features & benefits

- Feature smooth-faced steel modular drawers
- Drawers include full pull handles
- Base of cabinet is recessed in front to match handle pulls on drawers.

### Cabinets with modular drawers for hanging files

Item	Components	Dimensions			Shipping Weight
		H	W	D	
<b>1M23</b>	12" Modular drawers (includes 2)	28"	36"	18.5"	150.25 lbs.
<b>1M17</b>	6" Drawers (includes 2) 12" Modular drawer	28"	36"	18.5"	169.5 lbs.
<b>2M72</b>	12" Modular drawers (includes 2)	29.24"	36"	18.5"	168 lbs.
<b>4M72</b>	12" Modular drawers (includes 3)	41.24"	36"	18.5"	173 lbs.
<b>3M72</b>	12" Modular drawers (includes 4)	53.24"	36"	18.5"	201 lbs.
<b>5M72</b>	6" Drawer 12" Modular drawers (includes 4)	59.24"	36"	18.5"	247 lbs.

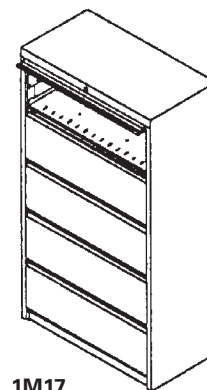

1M17

### Accessories

<b>UM77</b>	Back panel	5 lbs.
-------------	------------	--------

### Cabinets with 6" modular drawers

Item	Components	Dimensions			Shipping Weight
		H	W	D	
<b>4M32</b>	6" Drawers (includes 6)	41.24"	36"	18.5"	183 lbs.
<b>6M32</b>	6" Drawers (includes 10)	65.24"	36"	18.5"	279 lbs.

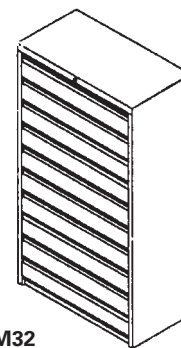

6M32

## Optimedia Storage System Sidewinder Tambour Cabinet

Optimedia

### Features & benefits

- Vertical PVC tambour doors that fully recede into the sides of the cabinet
- Doors glide smoothly and independently on internal tracks
- Two center handles are finished in black chrome

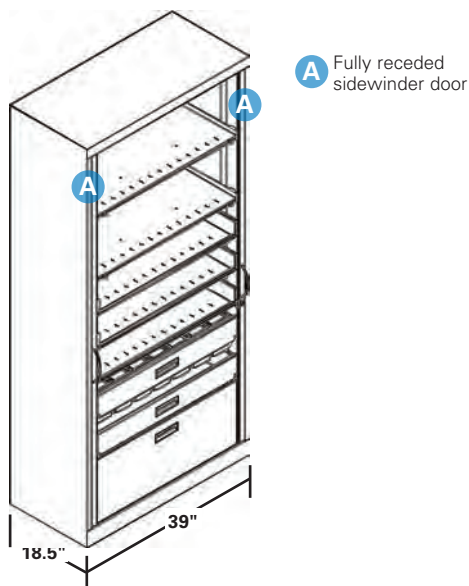

### Cabinets for binders and large books

Item	Levels	Media Height	Dimensions			Shipping Weight	Filing In. Per Level
			H	W	D		
<b>5Y65</b>	4	12"	59.24"	39"	18.5"	210 lbs.	33.56"
<b>6Y56</b>	4	13.5"	65.24"	39"	18.5"	217 lbs.	33.56"
<b>7Y56</b>	5	11.75"	71.24"	39"	18.5"	240 lbs.	33.56"
<b>8Y56</b>	6	11.6"	83.24"	39"	18.5"	271 lbs.	33.56"

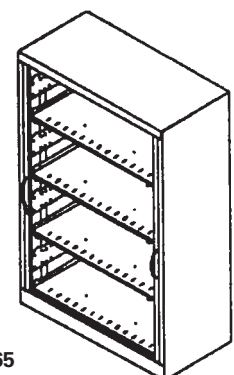

5Y65



## Optimedia Storage System

### Sidewinder Tambour - Standard Configurations

#### Cabinets for hanging files

Item	Levels	Components	Dimensions			Shipping Weight	Filing In. Per Level
			H	W	D		
<b>2Y11</b>	2		29.24"	39"	18.5"	179 lbs.	32.36"
<b>4Y11</b>	3		41.24"	39"	18.5"	159 lbs.	32.36"
<b>6Y11</b>	5		65.24"	39"	18.5"	221.5 lbs.	32.36"
<b>8Y11</b>	7	Fixed shelves at top (includes 2)	83.24"	39"	18.5"	275.5 lbs.	32.36"

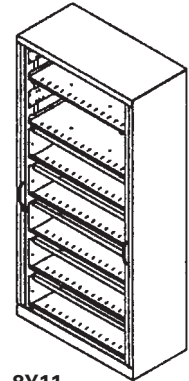

8Y11

#### Laboratory supplies cabinet

Item	Components	Dimensions			Shipping Weight
		H	W	D	
<b>8Y74</b>	Universal fixed shelves (includes 2) 12" Multipurpose bin drawers (includes 4)	83.24"	39"	18.5"	162 lbs.

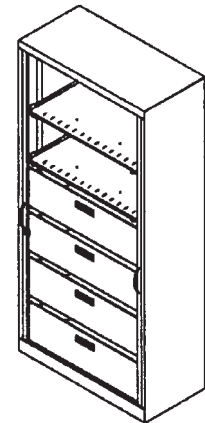

8Y74

#### Accessories

<b>UM77</b>	Back panel	5 lbs.
<b>UO47FF</b>	Center rails for front-to-back filing	1.5 lbs.

#### Mixed media cabinet

Item	Components	Dimensions			Shipping Weight
		H	W	D	
<b>8Y34</b>	Universal fixed shelves (includes 2) 4" Roll-out sheves without fronts (includes 3) Hanging frame with (6) hanging diskette files 4" Roll-out shelf with front 15" Multipurpose bin drawer	83.24"	39"	18.5"	302 lbs.

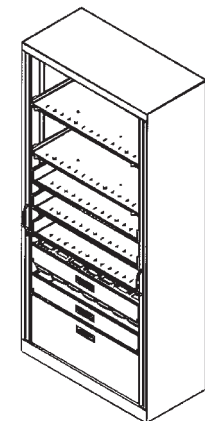

8Y34

## Sidewinder Tambour Cabinet - Standard Configurations

### Administrative support cabinets

Item	Components	Dimensions			Shipping Weight
		H	W	D	
<b>6Y36</b>	6 Level cabinet to include: Universal fixed shelf for media up to 8.25"H Organizer (unassembled) on fixed shelf 4" Roll-out shelf without front 4" Roll-out shelves with fronts (includes 2) 12" Multipurpose bin drawer	65.24"	39"	18.5"	266 lbs.
<b>8Y36</b>	7 Level cabinet to include: Universal fixed shelves for media up to 12.5" high (includes 2) Organizer (unassembled) on fixed shelf 4" Roll-out shelf without front 4" Roll-out shelves with fronts (includes 2) 12" Multipurpose bin drawer	84.24"	39"	18.5"	175 lbs.

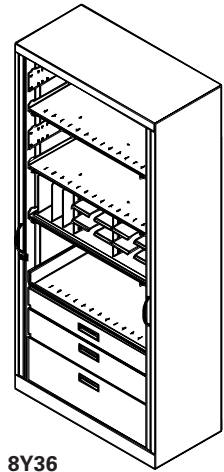

8Y36

### Multipurpose supply cabinets

Item	Components	Dimensions			Shipping Weight
		H	W	D	
<b>5Y67</b>	Universal fixed shelves (includes 2) Sets of dividers (includes 2) 4" Roll-outs with fronts (includes 2) 3 Rail divider kit Universal roll-out shelf 12" Multipurpose bin drawer	59.24"	39"	18.5"	262 lbs.
<b>8Y67</b>	Universal fixed shelves (includes 3) Sets of dividers (includes 2) 4" Roll-outs with fronts (includes 2) 3 Rail divider kit Universal roll-out shelves (includes 2) 12" Multipurpose bin drawer	83.24"	39"	18.5"	328 lbs.

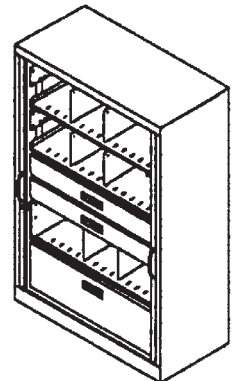

5Y67

### Accessories

<b>U048</b>	Optional compartment divider kit	10 lbs.
-------------	----------------------------------	---------

### Storage cabinets with fixed shelves

Item	No. of Levels	Dimensions			Shipping Weight
		H	W	D	
<b>8Y55</b>	6	83.24"	39"	18.5"	220 lbs.

### Accessories

<b>UM54</b>	Optional back panel kit	6.58"	33.66"	16.52"	7.5 lbs.
-------------	-------------------------	-------	--------	--------	----------

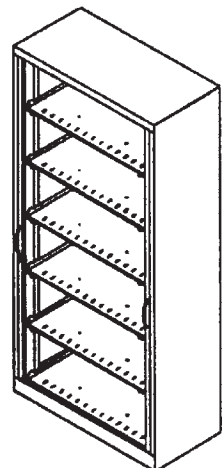

8Y55

## Optimedia Storage System

### Classic Tambour Cabinet

#### Features & benefits

- Feature smooth-faced PVC tambour doors which are torsion spring loaded to recede easily into the back of the cabinet
- Classic door locks into base of cabinet (includes lock no. 150000)

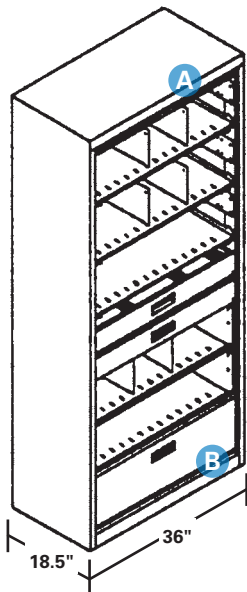

**A** Classic tambour door fully recedes at top of cabinet.

**B** Classic door locks into base of cabinet when closed.

#### Cabinets for binders and large books

Item	Levels	Media Height	Dimensions			Shipping Weight	Filing In. Per Level
			H	W	D		
<b>5M65</b>	4	12.3"	59.24"	36"	18.5"	189 lbs.	33.56"
<b>6M56</b>	4	13.8"	65.24"	36"	18.5"	203 lbs.	33.56"
<b>7M56</b>	5	12"	71.24"	36"	18.5"	226 lbs.	33.56"
<b>8M56</b>	6	11.8"	83.24"	36"	18.5"	249 lbs.	33.56"

#### Accessories

<b>U045FF</b>	Optional dividers (includes 3)	3.5 lbs.
---------------	--------------------------------	----------

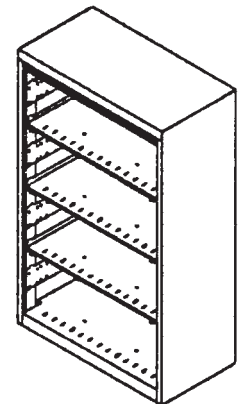

**5M65**



**Optimedia Storage System  
Classic Tambour Cabinet**

Optimedia

**Cabinets without doors for binders and large books**

Item	Levels	Media Height	Dimensions			Shipping Weight	Filing In. Per Level
			H	W	D		
<b>5M25</b>	4	12.3"	59.24"	36"	18.5"	189 lbs.	33.56"
<b>6M26</b>	4	13.8"	65.24"	36"	18.5"	188 lbs.	33.56"
<b>7M26</b>	5	12"	71.24"	36"	18.5"	210 lbs.	33.56"
<b>8M26</b>	6	11.8"	83.24"	36"	18.5"	240 lbs.	33.56"

**Accessories**

<b>U045FF</b>	Optional dividers (includes 3)	3.5 lbs.
---------------	--------------------------------	----------

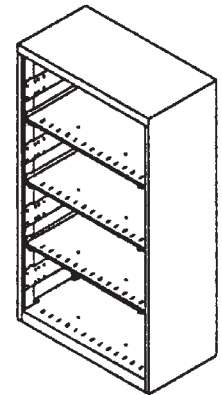

6M26

**Cabinets for binders and large books**

Item	Levels	Media Height	Dimensions			Shipping Weight	Filing In. Per Level
			H	W	D		
<b>1M52</b>	2	10.25"	28.00"	36"	18.5"	144 lbs.	33.56"
<b>2M52</b>	2	10.8"	29.24"	36"	18.5"	144 lbs.	33.56"
<b>4M52</b>	3	10.8"	41.24"	36"	18.5"	140 lbs.	33.56"
<b>5M66</b>	5	9.6"	59.24"	36"	18.5"	205 lbs.	33.56"
<b>7M57</b>	6	9.8"	71.24"	36"	18.5"	233 lbs.	33.56"
<b>7M59</b>	6 Cabinet with writing shelf	9.5"	71.24"	36"	18.5"	245 lbs.	33.56"
<b>8M59</b>	7 Cabinet with writing shelf	9.7"	83.24"	36"	18.5"	277 lbs.	33.56"

**Accessories**

<b>U045FF</b>	Optional dividers (includes 3)	3.5 lbs.
---------------	--------------------------------	----------

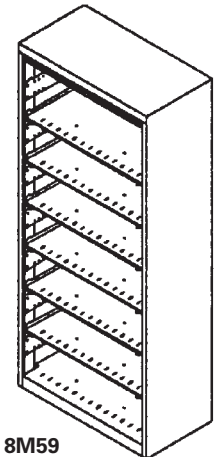

8M59

**LAN support cabinet**

Item	Components	Dimensions			Shipping Weight
		H	W	D	
<b>8M34</b>	Universal fixed shelves (includes 2) 4" Roll-outs shelves without fronts (includes 3) Hanging frame with (6) hanging diskette files 4" Roll-out shelf with front 15" Multipurpose bin drawer	83.24"	36"	18.5"	302 lbs.

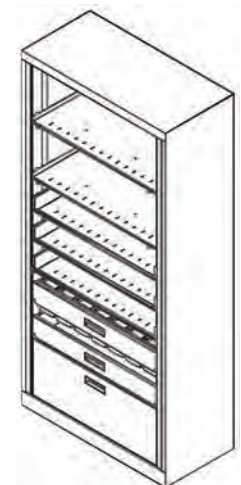

8M34

## Optimedia Storage System Classic Tambour Cabinet

### Multipurpose supply cabinets

Item	Components	Dimensions			Shipping Weight
		H	W	D	
<b>5M67</b>	Universal fixed shelves (includes 2) Sets of dividers (includes 2) 4" Roll-out shelves with fronts (includes 2) 3-Rail divider kit Universal roll-out shelf 2" Multipurpose bin drawer	59.24"	36"	18.5"	248.5 lbs.
<b>8M67</b>	Universal fixed shelves (includes 3) Sets of dividers (includes 2) 4" Roll-out shelves with fronts (includes 2) 3-Rail divider kit Universal roll-out shelves (includes 2) 12" Multipurpose bin drawer	83.24"	36"	18.5"	315 lbs.

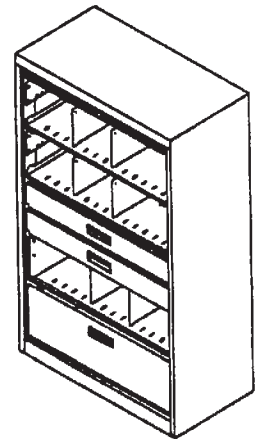

5M67

#### Accessories

<b>UO48FF</b>	Optional compartment divider kit	83.24"	36"	18.5"	10 lbs.
---------------	----------------------------------	--------	-----	-------	---------

### Storage cabinets with fixed shelves

Item	No. of Levels	Dimensions			Shipping Weight
		H	W	D	
<b>5M55</b>	4	59.24"	36"	18.5"	161 lbs.
<b>8M55</b>	6	83.24"	36"	18.5"	276 lbs.

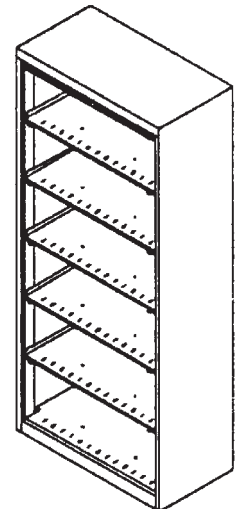

8M55

#### Accessories

<b>UM54</b>	Optional back panel kit				7.5 lbs.
-------------	-------------------------	--	--	--	----------

## Optimedia Storage System Extra-Deep Storage Cabinet

Optimedia

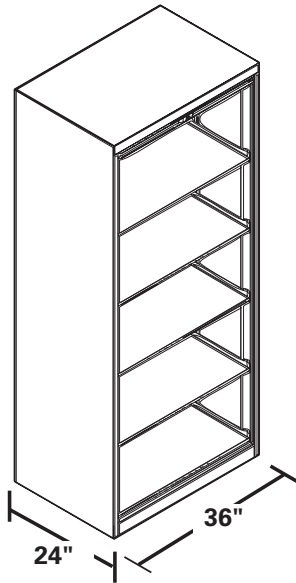

### Features & benefits

The Optimedia extra-deep storage cabinet provides storage capacity for large equipment, materials or supplies.

- 24" deep with heavy-duty fixed shelves
- 200 lb. weight capacity
- Classic tambour door is torsion spring loaded to recede easily into the back of the cabinet
- Shelves are installed on .25" slotted uprights, and can be adjusted to different heights

### Extra-deep storage cabinet

Item	No. of Levels	Dimensions			Shipping Weight
		H	W	D	
<b>8W55</b>	5-Level extra-deep storage cabinet	83.24"	36"	24"	254 lbs.
<b>8W56</b>	6-Level extra-deep storage cabinet	83.24"	36"	24"	270 lbs.
<b>UW02FF</b>	Extra-deep, heavy duty fixed shelf	6"	34"	21"	16.5 lbs.

- Each heavy-duty fixed shelf has a 200 lbs. weight-load capacity.

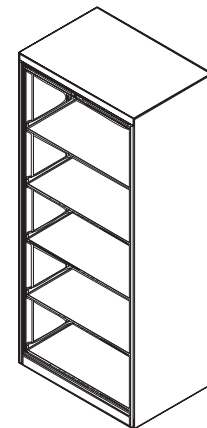

8W56



## Optimedia Storage System Components and Accessories

### Divided forms shelf

Item	Components	Dimensions			Shipping Weight	Space Req.
		H	W	D		
<b>UM22</b>	Divided forms shelf	9.75"	33.56"	11.5"	28 lbs.	10"

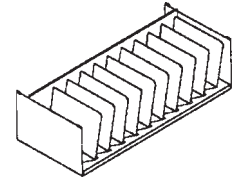

UM22

### Stackable shelf

Item	Components	Dimensions			Shipping Weight	Space Req.
		H	W	D		
<b>UM32</b>	Stackable shelf with 2 dividers	4.18"	33.58"	16.5"	10 lbs.	4.25"
<b>UM37</b>	Extra dividers (includes 2)				1 lbs.	
<b>UM38</b>	Brackets for UM32 (includes 2) (limit 5 shelves/pair of brackets)				1.54 lbs.	

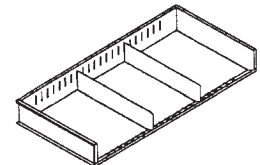

UM32

### File sorter

Item	Components	Dimensions			Shipping Weight	Space Req.
		H	W	D		
<b>UM64</b>	File sorter	11.31"	33"	15"	40 lbs.	12.5"
<b>UM65</b>	Additional 10" wide shelf				2.25 lbs.	
<b>UM66</b>	Additional 11" wide shelf				2.5 lbs.	

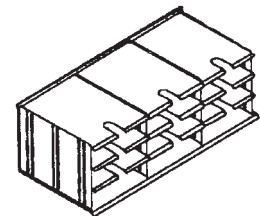

UM64

- To be inserted on a fixed shelf (AM01FF) which is ordered separately.
- Shelves and dividers are reconfigurable.
- Includes three (3) 10" and six (6) 11" wide adjustable shelves.
- Additional shelves may be ordered separately.

### 3-Rail divider kit

Item	Components	Dimensions			Shipping Weight
		H	W	D	
<b>UM41</b>	3-Rail divider kit	3.5"	32.36"	15.9"	5 lbs.
<b>U042</b>	Extra rails/compressors (includes 2)				1.5 lbs.

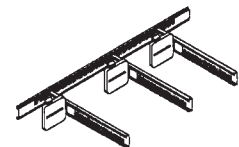

UM41

### Drawer mats

Item	Quantity	Shipping Weight
<b>UM80</b>	5	3 lbs.
<b>UM81</b>	10	4 lbs.

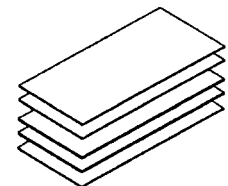

UM80

**Optimedia Storage System  
Components and Accessories**

**Wire racks**

Item	Media Compatibility	Req. Space	Capacity	Maximum Media Size		Shipping Weight
				D	W	
<b>UM40FM</b>	3480/90, 3590 Tapes	5.5"	91	1"	4.37"	5 lbs.
	Microfile	4.5"	91			
	Zip	4.5"	182 (2 per slot)			
	3.5" Optical disk	4.5"	182 (2 per slot)			
<b>UM48FM</b>	8mm Tapes	7" (angled)	102 (2 per slot)	1.75"	4.5"	6 lbs.
	Mini 1/4" data cartridges	4.5" (flat)				
	Audio cassettes Sony AIT, Ditto, Travan					
<b>UM44FM</b>	4mm Tapes	6.5" (angled)	176 264 SHARK (2 per slot)	1.32"	3.63"	5.5 lbs.
	SHARK DAT	4.5" (flat)				
<b>UM46FM</b>	CDs, RW optical disks	5.75"	115	.5"	5.69"	10 lbs.
<b>UM45FM</b>	CDs, RW optical disks	6.25"	180	.87"	5.23"	5.75 lbs.
<b>UM92FM</b>	CDs	6.25"	84	2.03"	5.23"	5 lbs.
<b>UM93FM</b>	CDs	6"	65	.98"	5.69"	5 lbs.
<b>UM51FM</b>	1/4" Data cartridges	5"	60	.94"	6.5"	5 lbs.
<b>UM50FM</b>	Digital linear tapes, TK50/70/85/88/857 .50" Compac tapes	5"	66 (in cases)	1.32"	4.88"	5 lbs.
<b>UM94FM</b>	JAZ Tapes, Magstar MP 3570 tapes	6"	75 (in cases)	.88"	5.44"	5 lbs.
<b>UM57FM</b>	Bernoulli disk	7"	88	1.24"	6.48"	6 lbs.
<b>UM59FM</b>	Syquest cartridge	7.5"	52			6 lbs.

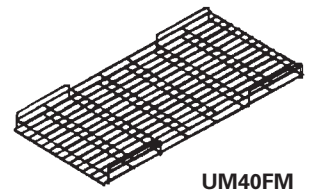
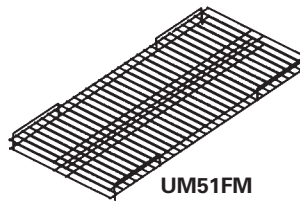
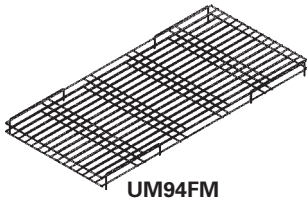

## Filing Companions Storage and Filing

Eaton's Filing Companions includes storage and filing options to complement our specialized multimedia cabinets. An extension of our mobile pedestal offering, they provide affordable storage solutions for conventional and personal filing needs.

- Pre-configured for easy ordering
- All models come with a limited lifetime warranty



### Wardrobe tower

Item	Description	Dimensions			Details
		H	W	D	
<b>WARD64L2</b>	2-Drawer model	64.1"	23.5"	23.5"	Full-height coat closet on left side with side-to-side coat rod, 37" upper cupboard with two adjustable shelves and two 12" x 19" file drawers.
<b>WARD64L3</b>	3-Drawer model	64.1"	23.5"	23.5"	Full-height coat closet on left side with side-to-side coat rod, 25" upper cupboard with one adjustable shelf with one 12" x 19" file drawers.

#### Wardrobe Tower additional dimensions:

- Interior closet clearance: 7.5"W
- Interior cupboard clearance: 15"W
- Interior file drawer: 19"D



**WARD64L3**

### Double door storage cabinet

Item	Description	Dimensions			Details
		H	W	D	
<b>DDCLA08F3</b>	4-High double-door model	51.38"	36"	18.14"	Features 3 adjustable shelves
<b>DDCLA11F3</b>	5-High double-door model	65.78"	36"	18.14"	Features 4 adjustable shelves



**DDCLA11F3**

### Bookcases

Item	Description	Dimensions			Details
		H	W	D	
<b>BCMBS3640</b>	3-High bookcase model	39.78"	36"	13.38"	Features 2 adjustable shelves
<b>BCMBS3652</b>	4-High bookcase model	51.38"	36"	13.38"	Features 3 adjustable shelves
<b>BCMBS3666</b>	5-High bookcase model	65.78"	36"	13.38"	Features 4 adjustable shelves



**BCMBS3640**



TechCart Mobile Furnishings



TechCart

## TechCart Mobile Furnishings

TechCart

- A** Plastic cable raceway cover easily snaps off to provide access to a full vertical raceway.
- B** TechCart components are adjustable on one inch centers. Mounting hardware attaches to plastic grommets for electrical isolation. Adjusting TechCart components is easy and requires no special tools.
- C** Shelves and worksurfaces feature fully radiused comfort edges.
- D** Large, four inch twin wheel casters make it a breeze to move TechCart around. Front casters are locking, suitable for office or production floors.
- E** Cable access ports (3.5" x 1.75") are located from top to bottom on TechCart uprights for a multitude of entry points to the vertical raceway. Power and data can be routed separately.

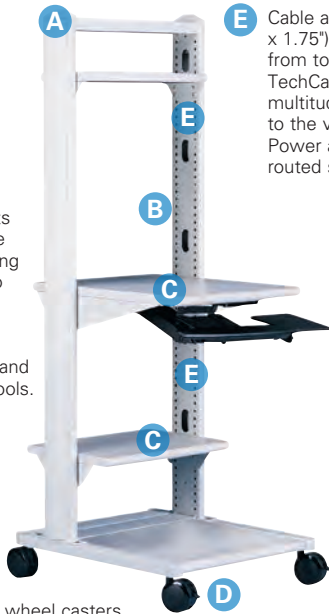

### Features & benefits

- “Best-in-class” reputation
- Impressive construction and durability
- Modular reconfigurable design
- Thoughtful ergonomics
- Technology-friendly cable and power management



### Laptop cart

Item	Description	Shipping Weight
<b>TCLT1800</b>	Laptop cart, 18 bay capacity with desktop cable port	225 lbs.
<b>TCLT1801</b>	Laptop cart, 18 bay capacity with PowerZone	225 lbs.
<b>TCLT2400</b>	Laptop cart, 24 bay capacity with desktop cable port	255 lbs.
<b>TCLT2401</b>	Laptop cart, 24 bay capacity with PowerZone	255 lbs.



### Peripheral cart

Item	Description	Dimensions			Shipping Weight
		H	W	D	
<b>TCPK0001</b>	Peripheral cart	20"	26"	24"	77 lbs.
<b>TCPK0002</b>	Peripheral cart	20"	32"	24"	88 lbs.



TechCart Mobile Furnishings

PC cart

Item	Description	Dimensions			Shipping Weight
		H	W	D	
TCPK0005	<b>PC cart</b>	65"	26"	30"	95 lbs.
	Top shelf worksurface		21.2" 21.2"	12" 30"	
TCPK0006	<b>PC cart</b>	65"	32"	30"	105 lbs.
	Top shelf Worksurface		27.2" 27.2"	12" 30"	



Transporter cart

Item	Description	Dimensions			Shipping Weight
		H	W	D	
TCPK0010	<b>Transporter cart</b>	46"	32"	30"	180 lbs.
	Top shelf		31.2"	30"	
	Bottom shelf Center shelves (qty. 2)		27.2" 27.2"	30" 30"	
TCPK0011	<b>Transporter cart</b>	46"	38"	30"	202 lbs.
	Top shelf		37.2"	30"	
	Bottom shelf Center shelves (qty. 2)		33.2" 33.2"	30" 30"	



Training station

Item	Description	Dimensions			Shipping Weight
		H	W	D	
TCPK0013	<b>Training station cart</b>	29"	32"	30"	81 lbs.
	Top mount worksurface		31.2"	30"	
TCPK0014	<b>Training station cart</b>	29"	38"	30"	87 lbs.
	Top mount worksurface		37.2"	30"	
TCPK0015	<b>Training station cart</b>	29"	48"	30"	102 lbs.
	Top mount worksurface		47.2"	30"	



Stand-up cart

Item	Description	Dimensions			Shipping Weight
		H	W	D	
TCPK0024	<b>Stand-up cart</b>	73"	26"	30"	117 lbs.
	Top shelf		21.2"	12"	
	Worksurface		21.2"	30"	
	Bottom shelf		21.2"	18"	



TechCart

## TechCart Mobile Furnishings

### Graphics & CAD cart

Item	Description	Dimensions			Shipping Weight
		H	W	D	
TCPK0030	<b>Graphics &amp; CAD cart</b>	29"	38"	30"	101 lbs.
	Top mount worksurface		37.2"	30"	
	Bottom shelf		33.2"	12"	
TCPK0031	<b>Graphics &amp; CAD cart</b>	29"	48"	30"	120 lbs.
	Top mount worksurface		47.2"	30"	
	Lower shelf		43.9"	12"	



### Video conference cart

Item	Description	Dimensions			Shipping Weight
		H	W	D	
TCPK0037	<b>Video conference cart</b>	46"	32"	30"	119 lbs.
	Center mount top shelf		31.2"	24"	
	Center mount shelf		27.2"	24"	
	Bottom shelf		27.2"	24"	
TCPK0038	<b>Video conference cart</b>	46"	38"	30"	130 lbs.
	Center mount top shelf		37.2"	24"	
	Center mount shelf		33.2"	24"	
	Bottom shelf		33.2"	12"	



### Storage cart

Item	Description	Dimensions			Shipping Weight
		H	W	D	
TCPK0040	<b>Storage cart frame with casters</b>	73"	32"	30"	135 lbs.
	Locking compartment with fabric covered door	16"	26.5"	15"	
	Center mounted shelves (qty. 2)		21.2"	18"	



### Presentation cart

Item	Description	Dimensions			Shipping Weight
		H	W	D	
TCPK0041	<b>Presentation cart</b>	65"	32"	30"	152 lbs.
	Center mounted shelves (qty. 3)		27.2"	30"	
TCPK0042	<b>Presentation cart</b>	65"	38"	30"	157 lbs.
	Center mounted shelves (qty. 3)		31.2"	30"	





TechCart Mobile Furnishings

Network cart

Item	Description	Dimensions			Shipping Weight
		H	W	D	
TCPK0057	<b>Network cart</b>	65"	26"	30"	120 lbs.
	Center mount shelf		21.2"	24"	
	Center mount shelf		21.2"	30"	
	and bottom shelf				
TCPK0058	<b>Network cart</b>	65"	32"	30"	143 lbs.
	Center mount shelf		27.2"	24"	
	Center mount shelf		27.2"	30"	
	and bottom shelf				



Analytical cart

Item	Description	Dimensions			Shipping Weight
		H	W	D	
TCPK0061	<b>Analytical cart</b>	46"	26"	30"	107 lbs.
	Top mount worksurface		25.2"	30"	
	Shelf		21.2"	18"	
	Storage shelf		21.2"	12"	



Design cart

Item	Description	Dimensions			Shipping Weight
		H	W	D	
TCPK0200	<b>Design cart</b>	42"	48"	36"	130 lbs.
	15° Forward tilt-adjustable center mount top shelf		48"	36"	
	Center mount shelf		43.9"	12"	



TechCart

## Paramount Enclosure System



Paramount



## Paramount Enclosure System

Paramount™ enclosures, with its accompanying integrated technologies, provides unmatched reliability to better store, cool, power, manage and secure your mission-critical electronics and servers.



### Features & benefits

- Unique design allows for easy reconfiguration for changing needs
- Available in a variety of heights, depths and widths
- Full line of accessories to meet the specific storage requirements of virtually all network equipment.

### Paramount enclosures

Item	Description	Shipping Weight
<b>Configured</b>	<b>Paramount 24" wide enclosure</b>	<b>322.4 lbs.</b>
<b>JW842440</b>	84"H x 24"W x 40"D Welded Paramount frame	109 lbs.
<b>JFTK24</b>	24"W Paramount frame trim kit	7 lbs.
<b>JSPS8440</b>	44U x 40"D Solid side panel (qty. 2)	84 lbs.
<b>JDF8424L</b>	84"H x 24"W Door frame - left hinged	21 lbs.
<b>JDP84242</b>	84"H x 24"W Fully perforated door with standard lock	7 lbs.
<b>WL100</b>	Removable lock core with 2 keys (qty. 2)	.4 lbs.
<b>JDD8421</b>	84"H x 24"W Split rear door, perforated	33 lbs.
<b>JTPS2440</b>	24"W x 40"D Solid top panel	12 lbs.
<b>JRM10000</b>	44U Paramount rail - 19" EIA - .375" square hole (includes 4)	49 lbs.

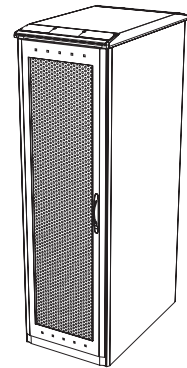

Item	Description	Shipping Weight
<b>Configured</b>	<b>Paramount add-on enclosure</b>	<b>238.4 lbs.</b>
<b>JW842440</b>	84"H x 24"W x 40"D Welded Paramount frame	109 lbs.
<b>JFTK24</b>	24"W Paramount frame trim kit	7 lbs.
<b>JDF8424L</b>	84"H x 24"W Door frame - left hinged	21 lbs.
<b>JDP84242</b>	84"H x 24"W Fully perforated door with standard lock	7 lbs.
<b>WL100</b>	Removable lock core with 2 keys (qty. 2)	.4 lbs.
<b>JDD8421</b>	84"H x 24"W Split rear door, perforated	33 lbs.
<b>JTPS2440</b>	24"W x 40"D Solid top panel	12 lbs.
<b>JRM10000</b>	44U Paramount rail - 19" EIA - .375" square hole (includes 4)	49 lbs.

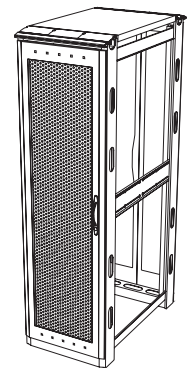

Item	Description	Shipping Weight
<b>Configured</b>	<b>Paramount 30" wide enclosure</b>	<b>398.4 lbs.</b>
<b>JW843040</b>	84"H x 30"W x 40"D Welded Paramount frame	115 lbs.
<b>JFTK30</b>	30"W Paramount frame trim kit	9 lbs.
<b>JSPS8440</b>	44U x 40D Solid side panel (qty. 2)	84 lbs.
<b>JDF8430L</b>	84"H x 30"W Door frame - left hinged	22 lbs.
<b>JDP84302</b>	84"H x 30"W Fully perforated door with standard lock	9 lbs.
<b>WL100</b>	Removable lock core with 2 keys (qty. 2)	.4 lbs.
<b>JDD8431</b>	84"H x 30"W Split rear door, perforated	35 lbs.
<b>JTP10005</b>	30"W x 40"D, High density solid top panel, OHCM	14 lbs.
<b>JRM10039</b>	44U Reducer rail - 19" EIA - .375" square hole (includes 4)	110 lbs.

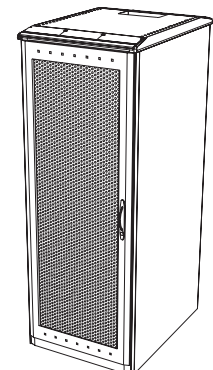

Paramount

## Seating





Seating

Eaton’s ergonomic seating portfolio includes something for every work environment. From 24/7 continuous shift and big and tall accommodations to executive office and task-intensive selections, we have a wide range of options for office, technical, lobby, and meeting room chairs.

- **24/7 Seating** designed to withstand constant use in around-the-clock environments.
- **General office seating** options for private workstations and guest seating, conference rooms and training environments.
- **Lab/industrial seating** provides the ergonomic support necessary for optimum comfort and productivity.



General Office



Task

Guest

Conference

## Colors & Finishes

### Laminate options for furniture



White Matrix (K)



Charcoal Matrix (G)

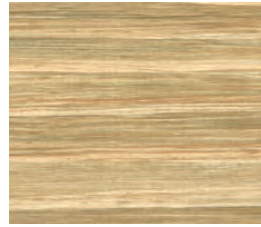

Buka Bark (C)



Lodestone (H)



Silver (V)



American Cherry (A)



Maple (Y)



Astro Strandz (Z)

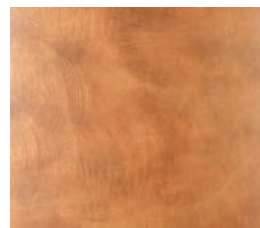

Antique Brush (Q)

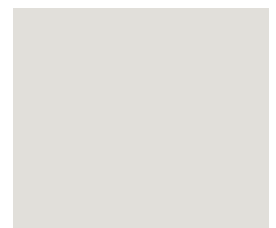

ESD Grey (E)

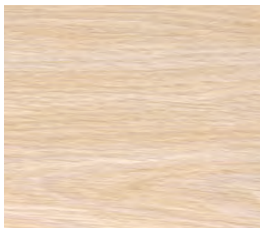

Beigewood (W)

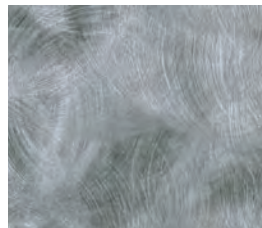

Pewter Brush (P)

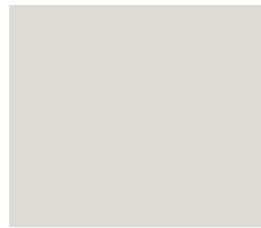

Folkstone Grey (L)

### Steel options for furniture



Black (M)

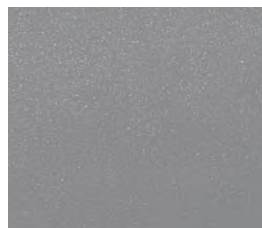

Titanium (V)



Metal Grey (H)

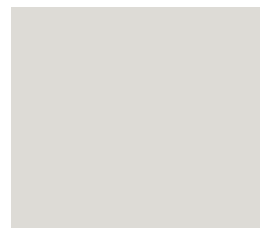

Nugrey (F)



Warm Brown II (R)

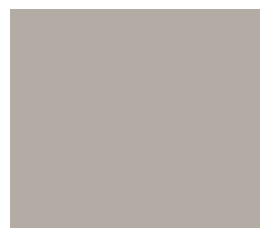

Bronze Taupe (D)

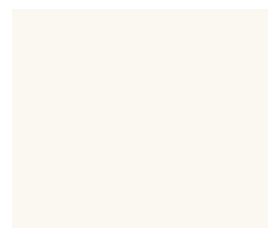

Cream White (C)

Colors & Finishes

Furniture matrix\*\*

Laminate	Compass™	LINX™	Optimedia™ (Sidewinder)	Optimedia™ (Classic)	Profile™	Foundations / LMS	TechCart	TechBench	Filing Companions	TechOrganizer
White Matrix (K)	•	•	•	•	•	•	•	•		
Charcoal Matrix (G)	•	•	•	•	•	•	•	•		
Buka Bark (C)	•	•	•	•	•	•	•	•		
Lodestone (H)	•	•	•	•	•	•	•	•		
Silver (V)	•	•	•	•	•	•	•	•		
American Cherry (A)	•	•	•	•	•	•	•	•		
Maple (Y)	•	•	•	•	•	•	•	•		
Astro Strandz (Z)	•	•	•	•	•	•	•	•		
Antique Brush (Q)	•	•	•	•	•	•	•	•		
ESD Grey (E)	•	•	•	•	•	•	•	•		
Beigewood (W)	•	•	•	•	•	•	•	•		
Pewter Brush (P)	•	•	•	•	•	•	•	•		
Folkstone Grey (L)	•	•	•	•	•	•	•	•		
Steel	Compass	LINX	Optimedia™ (Sidewinder)	Optimedia™ (Classic)	Profile	Foundations / LMS	TechCart	TechBench	Filing Companions	TechOrganizer
Black (M)	•	•	•	•	•	•	•	•	•	•
Titanium (V)	•				•	•*	•*	•		•*
Metal Grey (H)	•	•	•	•	•	•*	•*	•	•	•*
Nugrey (F)	•	•	•	•	•	•	•	•	•	•
Warm Brown II	•	•	•	•					•	•*
Bronze Taupe (D)					•*					
Cream White (C)	•	•	•	•	•	•	•	•	•	•
Wood	Compass	LINX	Optimedia™ (Sidewinder)	Optimedia™ (Classic)	Profile	Foundations / LMS	TechCart	TechBench	Filing Companions	TechOrganizer
Maple Hardwood								•		

\*Coordinating plastics available in Black only.

\*\*For Eaton's OnGuard command console color options, see the OnGuard Color Collections below and on next page.

Laminate trim matrix (Rounded bullnose edgebanding)

Laminate	Trim
White Matrix (K)	NuGrey
Charcoal Matrix (G)	Black
Buka Bark (C)	Warm Brown
Lodestone (H)	Metal Grey
Silver (V)	Black
American Cherry (A)	Black
Maple (Y)	Black
Astro Strandz (Z)	Metal Grey
Antique Brush (Q)	Black
ESD Grey (E)	NuGrey
Beigewood (W)	Metal Grey
Pewter Brush (P)	Metal Grey
Folkstone Grey (L)	NuGrey

Compass laminate trim matrix (Flat edgebanding)

Laminate	Trim
White Matrix (K)	NuGrey
Charcoal Matrix (G)	Black
Buka Bark (C)	Warm Brown
Lodestone (H)	Metal Grey
Silver (V)	Black
American Cherry (A)	American Cherry
Maple (Y)	Maple
Astro Strandz (Z)	Metal Grey
Antique Brush (Q)	Black
ESD Grey (E)	NuGrey
Beigewood (W)	Metal Grey
Pewter Brush (P)	Metal Grey
Folkstone Grey (L)	NuGrey

Paramount enclosure matrix

Steel Panels
NuGrey
Black
Steel Doors
Titanium
NuGrey
Black

OnGuard trim matrix

Name	Laminate	Steel	Edge Trim	Laminate Color	Steel Color	Edge Trim Color
Freedom	Buka Bark (C)	Bronze Taupe	Brown			
Heritage	American Cherry (A)	Black	Black			
Justice	Astro Strandz (Z)	Metal Grey	Grey			
Liberty	Antique Brush (Q)	Black	Black			
Patriot	Beigewood (W)	Titanium	Grey			
Revolution	Pewter Brush (P)	Titanium	Grey			

Note: Paramount enclosures (NuGrey or Black) come with black rails with white RU markings. Steel doors can be specified in additional colors if ordering a "configured to order" enclosure.

Colors and finishes



# GSA Product Catalog

Options

## OnGuard console color collections

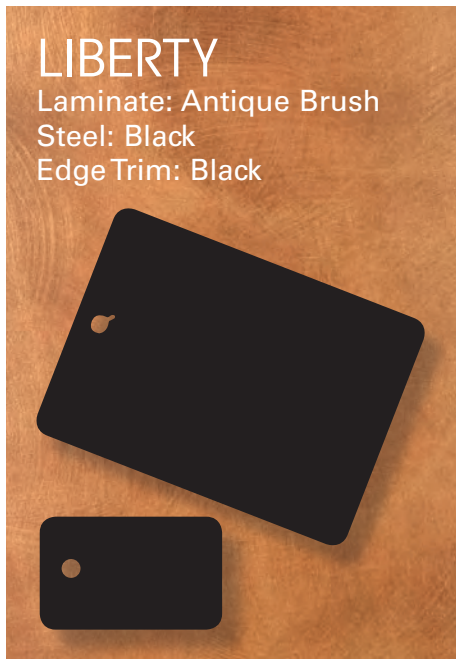
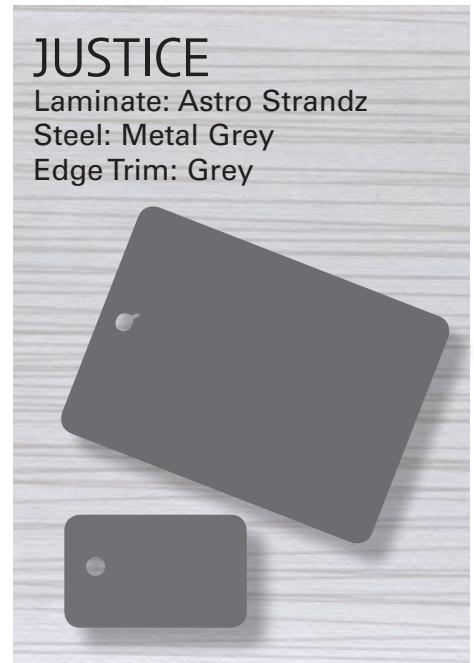
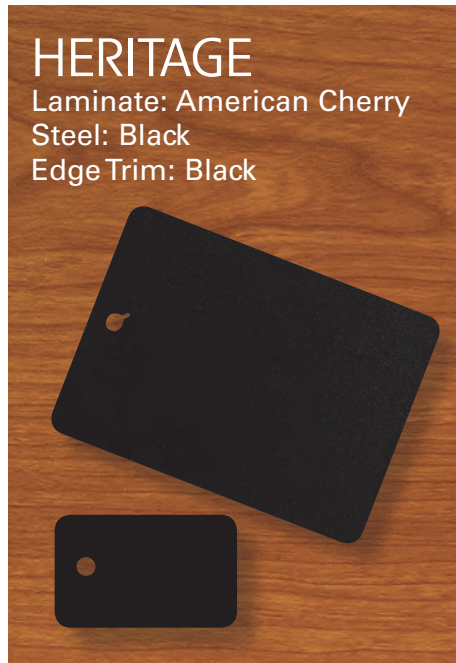

To contact an Eaton salesperson or local distributor, please visit [eaton.com/furniture](http://eaton.com/furniture) or call 800-225-7348.

**Eaton**  
1000 Eaton Boulevard  
Cleveland, OH 44122  
United States  
Eaton.com

© 2018 Eaton  
All Rights Reserved  
Printed in USA  
Publication No. CA210001EN  
May 2018 GSA-18

Eaton is a registered trademark.  
All other trademarks are property of their respective owners.